



EM 1110-2-5025  
31 July 2015

US Army Corps  
of Engineers®

**ENGINEERING AND DESIGN**

---

# **Dredging and Dredged Material Management**

**ENGINEER MANUAL**

## AVAILABILITY

Electronic copies of this and other U.S. Army Corps of Engineers (USACE) publications are available on the Internet at <http://publications.usace.army.mil/publications/>. This site is the only repository for all official USACE engineer regulations, circulars, manuals, and other documents originating from HQUSACE. Publications are provided in portable document format (PDF).

This document is intended solely as guidance. The statutory provisions and promulgated regulations described in this document contain legally binding requirements. The document is not a legally enforceable regulation itself, nor does it alter or substitute for those legal provisions and regulations it describes. Thus, it does not impose any legally binding requirements. This guidance does not confer legal rights or impose legal obligations upon any member of the public.

While every effort has been made to ensure the accuracy of the discussion in this document, the obligations of the regulated community are determined by statutes, regulations, or other legally binding requirements. In the event of a conflict between the discussion in this document and any applicable statute or regulation, this document would not be controlling.

This document may not apply to a particular situation based upon site-specific circumstances. USACE retains the discretion to adopt approaches on a case-by-case basis that differ from those described in this guidance where appropriate and legally consistent.

This document may be revised periodically without public notice.



CECW-EW

Manual  
No. 1110-2-5025

31 July 2015

Engineering and Design  
DREDGING AND DREDGED MATERIAL MANAGEMENT

1. Purpose. This Engineer Manual (EM) presents a comprehensive summary of the dredging equipment and dredged material placement techniques used by the U.S. Army Corps of Engineers (USACE), and it describes management and design processes associated with new-work and maintenance dredging related to navigation projects. Guidance is provided on the following dredging topics:

- a. Evaluation and selection of dredging equipment for various materials to be dredged.
- b. Planning, designing, constructing, operating, and managing environmentally acceptable open-water and confined dredged material placement areas for both short- and long-term placement (disposal) needs.
- c. Planning, designing, developing, and managing dredged material for beneficial uses while incorporating ecological concepts and engineering designs with environmental, economical, and social feasibility.

In this document, the terms “placement” and “disposal” are used synonymously to describe dredged material deposition after its removal from the dredging prism.

2. Applicability. This manual applies to all USACE Commands having responsibilities for administering USACE dredging programs.

3. Distribution Statement. This publication is approved for public release; distribution is unlimited.

4. Scope of the Manual. Chapter 1 provides an overview of the USACE dredging program. Chapter 2 describes USACE navigation project dredging management processes and provides a comprehensive summary of the dredging equipment used by USACE for activities associated with new work and maintenance projects. It also provides guidance on the evaluation and selection of dredging equipment, presents an overview of environmental impacts from dredging, and discusses the evaluation, selection, and management of placement alternatives. Chapter 3 describes open-water placement and the major hydrodynamic environments associated with it.

---

This manual supersedes EM 1110-2-5025, 25 March 1983; EM-1110-2-5026, 30 June 1987; and EM 1110-2-5027, 30 September 1987.

31 July 15

Considerations in the selection and use of various types of dredging equipment and techniques for placement are presented. The short- and long-term fates of dredged material in the open-water environment are described, and methods for quantifying each type are presented. Chapter 3 also discusses the evaluation of contaminant pathways from open-water placement and management and control methods for open-water placement, and it addresses considerations for open-water site operation, monitoring, and management. Chapter 4 provides detailed guidance for confined (diked) placement of dredged material in confined disposal facilities (CDFs). Guidance for evaluating site conditions, dike design, retention of dredged material, initial storage requirements during placement, long-term storage capacity, dredged material dewatering, dike design, contaminant pathways and controls, operation and management, and monitoring is also presented. Chapter 5 outlines various opportunities for the beneficial use of dredged material and provides many case studies. One of the most common beneficial uses for dredged material is as substrate for habitat development. The chapter outlines the important design elements for several habitats, ranging from aquatic to upland. Other uses for dredged material include agriculture, horticulture, aquaculture, forestry, strip mine reclamation, solid waste landfill, harbors and port development, and fill for many other types of projects. Dredged material has a wide variety of uses. Wherever sediment is needed, dredged material could be the source. Economics generally dictate whether a given beneficial use is feasible. Some guidance for estimating costs is provided as well as engineering properties of dredged material pertinent to the variety of beneficial uses.

FOR THE COMMANDER:

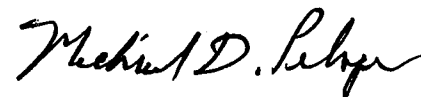

MICHAEL D. PELOQUIN  
COL, EN  
Chief of Staff

16 Appendixes  
(See Table of Contents)

CECW-EW

Manual  
No. 1110-2-5025

31 July 2015

Engineering and Design  
DREDGING AND DREDGED MATERIAL MANAGEMENT

TABLE OF CONTENTS

	<u>Paragraph</u>	<u>Page</u>
CHAPTER 1. Introduction		
Purpose	1.1	1-1
Applicability	1.2	1-1
Distribution	1.3	1-1
References	1.4	1-1
Background	1.5	1-1
Considerations Associated with Dredging and Dredged Material Placement	1.6	1-4
Scope	1.7	1-4
Training	1.8	1-5
Related Publications	1.9	1-6
Explanation of Abbreviations	1.10	1-7
Metrics	1.11	1-7
Appendices	1.12	1-7
CHAPTER 2. Dredging and Navigation Project Management		
Purpose	2.1	2-1
Section I. Overview of Dredging and Navigation Project Management		
Introduction	2.2	2-1
Federal Navigation Project Formulation	2.3	2-1
Federal Legislation	2.4	2-2
National Dredging Policy	2.5	2-6
Long-Term Management Strategy and Dredged Material Management Plans	2.6	2-8
USACE Dredging Policy	2.7	2-10
Regional Sediment Management	2.8	2-11
Engineering With Nature	2.9	2-12

	<u>Paragraph</u>	<u>Page</u>
Dredge Operation Safety	2.10	2-12
Section II. Project Site Characterization		
Background	2.11	2-14
Dredging Locations and Quantities	2.12	2-15
Dredging Site Geotechnical Investigations	2.13	2-16
Placement Site Geotechnical Investigations	2.14	2-36
Sediment Physical and Engineering Properties Testing	2.15	2-37
Laboratory Tests for Containment Facilities	2.16	2-49
Site Contamination Characterization	2.17	2-59
Cultural Resources and Munitions and Explosives of Concern	2.18	2-60
Section III. Dredging Equipment and Techniques		
Purpose	2.19	2-62
Factors Determining Equipment Selection	2.20	2-62
Dredge Types	2.21	2-62
Hydraulic Pipeline Cutterhead Dredges	2.22	2-64
Trailing Suction (Hydraulic) Hopper Dredges	2.23	2-71
Hydraulic Pipeline Dustpan Dredges	2.24	2-78
Sidecasting Dredges	2.25	2-81
Mechanical “Bucket” Dredges	2.26	2-83
Mechanical “Backhoe” Dredges	2.27	2-88
Special-Purpose Dredge	2.28	2-90
Dredge Operating Characteristics and Production Rates	2.29	2-92
Agitation Dredging Techniques	2.30	2-95
Dredging Instrumentation	2.31	2-103
Environmental Dredging	2.32	2-118
Section IV. Dredging Environmental Considerations		
Introduction	2.33	2-121
Sediment Resuspension Due to Dredging	2.34	2-121
Biological Considerations	2.35	2-130
Environmental Windows	2.36	2-131
Section V. Evaluation of Placement Alternatives		
Background	2.37	2-137
Technical Framework	2.38	2-139
Risk Analysis	2.39	2-148

	<u>Paragraph</u>	<u>Page</u>
Dredging and Dredged Material Management Software Tools	2.40	2-150
CHAPTER 3. Open-Water Placement		
Overview of Open-Water Placement	3.1	3-1
Open-Water Environments for Dredging and Placement	3.2	3-4
Physical Fate of Dredged Material Placed in Open Water	3.3	3-9
Open-Water Disposal Site Designation/Selection	3.4	3-26
Evaluation of Direct Physical Effects and Site Capacity	3.5	3-35
Evaluation of Contaminant Pathways from Open-Water Disposal	3.6	3-37
Water Column and Benthic Control Measures for Open-Water Disposal	3.7	3-44
Open-Water Site Management and Monitoring	3.8	3-53
CHAPTER 4. Confined (Diked) Placement		
Overview of Confined Placement	4.1	4-1
Site Selection and Investigations	4.2	4-14
Laboratory Testing Requirements	4.3	4-19
Retention of Solids and Initial Storage	4.4	4-21
Design and Management for Long-Term Storage Capacity	4.5	4-35
Design and Construction of Retaining Dikes and Structures	4.6	4-60
Contaminant Pathway Analysis	4.7	4-88
Control and Treatment of Effluent and Other Discharges	4.8	4-98
Contaminant Controls and Treatment	4.9	4-104
Operation and Management	4.10	4-113
Monitoring	4.11	4-128
CHAPTER 5. Beneficial Uses of Dredged Material		
Section I. Dredged Material as a Resource		
Introduction	5.1	5-1
Physical and Engineering Characteristics	5.2	5-2
Chemical Characteristics	5.3	5-6
Water Quality Considerations	5.4	5-7
Contaminated Dredged Material	5.5	5-9
Biological Limitations	5.6	5-9
Section II. Logistical Considerations		
General	5.7	5-11

	<u>Paragraph</u>	<u>Page</u>
Dewatering	5.8	5-12
Transport, Handling, and Storage	5.9	5-12
Cost Analysis for Dewatering and Transport	5.10	5-18
Section III. Habitat Development		
Definition and Application	5.11	5-21
Case Studies of Selected Habitat Development Sites	5.12	5-22
Habitat Development Selection Process	5.13	5-28
Section IV. Wetland Habitats		
Marshes	5.14	5-32
Marsh Development Considerations	5.15	5-33
Guidelines for Marsh Development	5.16	5-34
Engineering Aspects of Wetland Habitat Development	5.17	5-47
Wooded Wetland Habitats	5.18	5-54
Guidelines for Wooded Wetland Development	5.19	5-56
Section V. Upland Habitats		
General	5.20	5-63
Upland Habitat Development Considerations	5.21	5-63
Guidelines for Upland Development	5.22	5-64
Upland Site Development	5.23	5-67
Engineering Design of Upland Sites	5.24	5-71
Ecological Design of the Upland Sites	5.25	5-74
Dredging and Placement Operations	5.26	5-75
Section VI. Island Habitats		
General	5.27	5-76
Island Development and Management	5.28	5-78
Development and Management Problems	5.29	5-88
Section VII. Aquatic Habitats		
General	5.30	5-88
Aquatic Habitat Development	5.31	5-89
Guidelines for Aquatic Habitat Development	5.32	5-90
Design of Sea Grass Habitat	5.33	5-91
Clam Flats, Oyster Beds, Mussel Beds, and Other Shellfish Habitats	5.34	5-95
Artificial Reefs and Underwater Berms	5.35	5-95

	<u>Paragraph</u>	<u>Page</u>
Section VIII. Beaches and Beach Nourishment		
General	5.36	5-96
Types of Beach Nourishment	5.37	5-97
Environmental Considerations	5.38	5-98
Section IX. Parks and Recreation		
General	5.39	5-103
Case Studies	5.40	5-104
Recreation Activities and Facilities	5.41	5-107
Recreation Carrying Capacity	5.42	5-110
Section X. Agriculture, Horticulture, Forestry, and Aquaculture		
General	5.43	5-111
Agriculture	5.44	5-111
Horticulture	5.45	5-120
Forestry	5.46	5-122
Aquaculture	5.47	5-123
Section XI. Strip Mine Reclamation, Solid Waste Landfill, and Alternative Uses		
General	5.48	5-129
Strip Mine Reclamation	5.49	5-129
Solid Waste Landfills	5.50	5-135
Section XII. Multipurpose Uses and Other Land Use Concepts		
General	5.51	5-137
Case Studies	5.52	5-138
Other Land Use Concepts	5.53	5-142
Section XIII. Construction and Industrial/Commercial Uses		
Harbor and Port Facilities	5.54	5-150
Residential and Urban Use	5.55	5-151
Airports	5.56	5-154
Dikes, Levees, and Containment Facilities	5.57	5-155
Fill Material and Roads	5.58	5-156
Islands and Historic Preservation	5.59	5-156

	<u>Paragraph</u>	<u>Page</u>
Considerations	5.60	5-157
Section XIV. Baseline and Monitoring Studies		
General	5.61	5-158
Monitoring	5.62	5-158
Section XV. Site Valuation		
Evaluation	5.63	5-164
Methodology	5.64	5-165
Case Studies	5.65	5-167
Use of the Methodology	5.66	5-167
 APPENDICES		
APPENDIX A. References		
Required Publications	A.1	A-1
Related Publications	A.2	A-8
 APPENDIX B. Dredging Environmental Considerations		
Introduction	B.1	B-1
Sediment Resuspension Caused by Different Dredges	B.2	B-1
Generation of Turbidity by Type of Dredge	B.3	B-2
Measures to Reduce Sediment Resuspension	B.4	B-16
Dissolved Oxygen (DO) Reduction and Contaminant Mobilization	B.5	B-19
Biological Considerations	B.6	B-21
Effects of Environmental Alterations on Fishes	B.7	B-22
Effects of Environmental Alterations on Shellfishes	B.8	B-32
Effects of Environmental Alterations on Benthic Assemblages	B.9	B-38
Effects of Environmental Alterations on Endangered Species, Sea Turtles, Marine Mammals, and Colonial- Nesting Birds	B.10	B-43
 APPENDIX C. Confined Aquatic Disposal		
Background	C.1	C-1
Site Selection and Evaluation	C.2	C-2
Design, Construction, and Operations	C.3	C-5
Cap Design and Material	C.4	C-5



	<u>Paragraph</u>	<u>Page</u>
Monitoring	C.5	C-7
Conclusions	C.6	C-8
 APPENDIX D. Plant Materials for Beneficial Use Sites		
Plants for Habitat Development	D.1	D-1
Recommended Propagules	D.2	D-36
 APPENDIX E. Common and Scientific Names of Plants and Animals Mentioned in This Manual		
Plants	E.1	E-1
Animals	E.2	E-18
 APPENDIX F. Automated Dredging and Disposal Alternatives Modeling System (ADDAMS)		
Purpose	F.1	F-1
Background	F.2	F-1
Description of ADDAMS	F.3	F-1
General Instructions	F.4	F-3
Availability of ADDAMS	F.5	F-5
Revisions, Updates, and Workshops	F.6	F-5
Description of ADDAMS Applications	F.7	F-6
 APPENDIX G. Plans and Specifications for Settling Columns		
Purpose	G.1	G-1
Side-View Sedimentation Column Plan and Specifications	G.2	G-1
Top and Bottom Sedimentation Column Plans	G.3	G-2
 APPENDIX H. Column Settling Test Procedures		
General	H.1	H-1
Settling Processes	H.2	H-1
Testing Equipment and Procedures	H.3	H-2
Flocculant Settling Test	H.4	H-4
Zone Settling Test	H.5	H-6
Compression Settling Test	H.6	H-7
 APPENDIX I. Design Calculations for Retention of Solids and Initial Storage		
General	I.1	I-1

	<u>Paragraph</u>	<u>Page</u>
Volume for Initial Storage	I.2	I-1
Minimum Surface Area for Effective Zone Settling	I.3	I-6
Required Retention Time of Suspended Solids	I.4	I-9
Estimation of Hydraulic Efficiency Correction Factor	I.5	I-13
Example Design Calculations for Retention of Solids and Initial Storage	I.6	I-14
 APPENDIX J. Dredged Material Consolidation Test Procedures		
General	J.1	J-1
Consolidation Testing	J.2	J-1
Recommended Oedometer Test Procedure	J.3	J-2
Calculation of Permeability	J.4	J-5
 APPENDIX K. Jar Test Procedures for Chemical Clarification		
General	K.1	K-1
Selection of Test Conditions	K.2	K-2
 APPENDIX L. Estimation of Dredged Material Consolidation by Finite Strain Technique		
General	L.1	L-1
Estimation of Consolidation Using the Finite Strain Technique	L.2	L-1
Empirical Estimate of Settlement due to Desiccation	L.3	L-6
Example Consolidation Calculations	L.4	L-11
 APPENDIX M. Procedures and Example Calculations for Design of a Chemical Clarification System		
Design Procedures	M.1	M-1
Polymer Feed System Design Example	M.2	M-15
Example Culvert Design	M.3	M-17
Design Example	M.4	M-19
Mud Pumping	M.5	M-21
 APPENDIX N. Monthly Standard Class "A" Pan Evaporation for the Continental United States		
Purpose	N.1	N-1
Evaporation Charts	N.2	N-1

	<u>Paragraph</u>	<u>Page</u>
APPENDIX O. Procedures for Selecting Equipment for Dewatering Operations		
General Procedures	O.1	O-1
Effects of Trenching	O.2	O-1
APPENDIX P. Dye Tracer Technique to Estimate Mean Residence Time and Hydraulic Efficiency		
Fluorescent Dyes	P.1	P-1
Measurement Techniques	P.2	P-2
Sampling	P.3	P-4
GLOSSARY		
Abbreviations		Glossary-1

	<u>Page</u>
<b>LIST OF TABLES</b>	
Table 2-1. HRDP-Measured Densities Compared with Pycnometer-Measured Densities	2-22
Table 2-2. Standard Geotechnical Test Procedures	2-38
Table 2-3. Grain-Size Identification	2-40
Table 2-4. Sediment Particle Sizes	2-41
Table 2-5. Typical Weight-Volume Properties of Soils	2-45
Table 2-6. Soil Density or Consistency from Standard Penetration Test Data	2-48
Table 2-7. Relationship of Concentration in Percent Solids by Weight, Percent Solids by Volume, Concentration in Grams Per Liter, and Water Content	2-53
Table 2-8. Hydraulic Pipeline Dredge Discharge Rates	2-66
Table 2-9. Dredge Excavation, Removal, Transport, and Placement Processes	2-93
Table 2-10. Summary of Dredge Operating Characteristics	2-94
Table 2-11. Hopper Dredge Instrumentation	2-108
Table 2-12. Dredging Parameters Monitored by USACE Districts	2-110
Table 2-13. Hopper Dredge Implementation and Calculated Data Parameter Values	2-116
Table 2-14. USACE District Offices Receiving an Environmental Windows Survey	2-133
Table 2-15. Distribution of Environmental Windows Categories by USACE Divisions	2-134
Table 2-16. Distribution of Supporting Rationales for Environmental Windows by USACE Divisions	2-135
Table 3-1. USACE Short-Term Fate Models	3-25
Table 3-2. Effect of Pipeline Configuration on Dredged Material Dispersion	3-45
Table 4-1. Site Characteristics Affecting Groundwater Impacts	4-17
Table 4-2. Comparison of Small Strain and Finite Strain Consolidation Techniques	4-43
Table 4-3. Factors Affecting the Extent of Field Investigations and Design Studies	4-65
Table 4-4. Stages of Field Investigation	4-66
Table 4-5. Preliminary Appraisal of Foundation Strengths	4-67
Table 4-6. Laboratory Testing of Fine-Grained Cohesive Soils	4-68
Table 4-7. Laboratory Testing of Coarse-Grained Noncohesive Soils	4-69
Table 4-8. Applicable Shear Strengths and Recommended Minimum Factors of Safety	4-73
Table 4-9. Equipment Commonly Used in Dike Construction	4-80
Table 4-10. Commonly Used Methods of Transporting Soils in Dike Construction	4-83
Table 4-11. Commonly Used Methods of Compacting Soils in Dike Construction	4-84
Table 4-12. Operations or Items to be Inspected During Dike Construction	4-84
Table 4-13. Descriptions of Geotextile Functions	4-87
Table 4-14. Treatment Alternatives for Remediation of Contaminated Sediments	4-110
Table 5-1. Available Water Capacity of Soils of Different Grain Size Range	5-4
Table 5-2. Available Water Capacity Suitable for Agricultural Crops	5-4
Table 5-3. Recommended Maximum Limits for Metal Content in Digested Sewage Sludges	5-8

	<u>Page</u>
Table 5-4. Sequence of Steps in Selecting a Transport Route	5-13
Table 5-5. Operational Characteristics of Trenching Equipment	5-19
Table 5-6. Estimated Interval Between Trenching Cycles for Various Equipment Items in Fine-Grained Dredged Material	5-20
Table 5-7. Comparison of Costs of Various Transport Systems, Quantities, and Distances	5-21
Table 5-8. Types of Recreational Activities and Facilities Found on Dredged Material Placement Sites	5-109
Table 5-9. Average Range of Heavy Metal Uptake by Plants for Selected Food Crops and Suggested Plant Tolerance Levels	5-113
Table 5-10. Case Study Site Physical and Dredged Material Characteristics	5-168
Table 5-11. Case Study Site Settings	5-169
Table 5-12. Case Study Site Valuation Study	5-170
Table 5-13. Case Study Sites—Associated Benefits/Adverse Impacts	5-171
Table B-1. Turbidity and Suspended Solids Concentrations at Different Cutter Speeds Using a 69 cm (27 in.) Dredge	B-3
Table B-2. Spatial and Temporal Characteristics of Suspended Sediment Fields During Hydraulic Cutterhead Dredging Operations	B-6
Table B-3. Spatial and Temporal Characteristics of Suspended Sediment Fields During Hopper Dredging Operations	B-9
Table B-4. Spatial and Temporal Characteristics of Suspended Sediment Fields During Bucket Dredging Operations	B-10
Table B-5. Summary of (Near-Field) Background Turbidity Statistics, FTU	B-12
Table B-6. General Characteristics of Suspended Sediment (SS) Fields Around Three Commonly Used Dredge Types	B-15
Table B-7. Average Concentrations (mg/L, Absolute Values) of Selected Contaminants Released During Dredging of Contaminated Sediments	B-21
Table B-8. Results of Experimental Determinations of Effects of Suspended Sediments on Various Life History Stages of Fishes	B-25
Table B-9. Entrainment Rates (Organisms/yd <sup>3</sup> Dredged) of Fishes Reported for Dredges in Grays Harbor, WA, and the Columbia River, OR and WA	B-30
Table B-10. Results of Experimental Determinations of Effects of Suspended Sediments on Various Life History Stages of Shellfishes	B-33
Table B-11. Entrainment Rates Reported for Three Dredge Types in Grays Harbor, WA	B-37
Table D-1. Selected Upland Plant Species for Habitat Development on Dredged Material Sites	D-1
Table D-2. Recommended Propagules and Techniques for Selected Marsh Species	D-36
Table E-1. Common and Scientific Names of the Plants Mentioned in this Manual	E-1
Table E-2. Common and Scientific Names of the Animals Mentioned in this Manual	E-18

	<u>Page</u>
Table I-1. Recommended Resuspension Factors for the Zone Settling Case for Various Poned Areas and Depths	I-11
Table I-2. Observed Flocculant Settling Concentrations with Depth, in Grams per Liter	I-16
Table I-3. Percent of Initial Concentration with Time	I-17
Table I-4. Concentration of Settled Solids as a Function of Time	I-17
Table I-5. Removal Percentages as a Function of Settling Time	I-22
Table I-6. Depth to Solids Interface as a Function of Settling Time at $C_i = 150$ g/L	I-27
Table I-7. Concentration of Settled Solids as a Function of Time	I-27
Table I-8. Observed Flocculant Settling Data	I-29
Table I-9. Percentage of Initial Concentration and Suspended Solids Concentration Versus Time, Ponding Depth of 2 Ft	I-35
Table K-1. Design Mixing Values Gt	K-4
Table L-1. Void Ratio Distribution and Ultimate Settlement Calculations	L-13
Table L-2. Percent Consolidation and Settlement Calculations	L-18

	<u>Page</u>
<b>LIST OF FIGURES</b>	
Figure 1-1. USACE Dredging Program—Average Annual Dredging FY 2008-2012, Including both USACE and Contractor Dredging, Broken Down by Location and Class of Work	1-3
Figure 1-2. USACE Dredging Program—Percentage of Average Annual yardage of Dredged Material FY 2008-2012, Including both USACE and Contractor Dredging, Broken Down by Class of Work	1-3
Figure 2-1. NEPA Process for Dredging and Dredged Material Placement Projects	2-4
Figure 2-2. Geographical Jurisdictions of the MPRSA and CWA	2-6
Figure 2-3. Engineering With Nature (EWN)—A Sustainable Approach	2-12
Figure 2-4. Procedure for a Geotechnical Site Investigation	2-19
Figure 2-5. High-Resolution Density Profiler (HRDP) and its Immersion in a Static (Fluid Mud) Bucket Test	2-22
Figure 2-6. STEMA RheoTune Tuning Fork Shear Strength, Viscosity, and Density Probe	2-23
Figure 2-7. STEMA RheoTune Probe Being Deployed off the New Orleans District's S/V Teche via a Semi-Automated Winch	2-24
Figure 2-8. STEMA DensiTune Measurements Taken in 42 ft (12.8 m) at the Right Quarterline of the Calcasieu Bar Channel on 5 October 2011, One Week after a Wheeler Dredging Exercise	2-25
Figure 2-9. SILAS-Generated Cross Section of the Gulfport Ship Channel, Illustrating the Concept of Measuring the Top of Fluid Mud, 1.2 g/cm <sup>3</sup> Density Horizon, and the Top of Consolidated Material	2-26
Figure 2-10. SILAS-Analyzed Density Horizons (1.20 g/cm <sup>3</sup> , 1.16 g/cm <sup>3</sup> , and 1.03 g/cm <sup>3</sup> ) of STA 180+00 Gulfport Ship Channel, 9 April 2012, Relative to the Channel Template	2-26
Figure 2-11. Grab Sediment Samplers	2-31
Figure 2-12. Phleger Gravity Corer	2-32
Figure 2-13. Alpine Vibracorer	2-32
Figure 2-14. Box Corer	2-34
Figure 2-15. Split-Spoon Sampler	2-35
Figure 2-16. Typical Diamond Coring Bit	2-35
Figure 2-17. Typical Grain-Size Distribution Curves	2-39
Figure 2-18. Casagrande Plasticity Chart for Cohesive Soils	2-42
Figure 2-19. Weight-Volume Relationships	2-44
Figure 2-20. Flowchart Depicting Laboratory Testing for Containment Area Design	2-50
Figure 2-21. Relationship of Concentration in Percent Solids by Weight, Percent Solids by Volume, Concentration in Grams Per Liter, and Water Content	2-54
Figure 2-22. Percentage of Work Completed by Dredge Type with Respective Yardages for USACE Districts (Includes both Contractor and USACE Plant, Dredging an Average Annual Volume [FY 2008-2012] of 175 Million yd <sup>3</sup> /yr)	2-65

	<u>Page</u>
Figure 2-23 Percentage of Work Conducted by Dredge Type of an Average Annual Yardage (FY 2008-2012) of 175 Million yd <sup>3</sup> /yr (Includes both USACE and Contractor Plant)	2-65
Figure 2-24. Hydraulic Pipeline Cutterhead Dredge	2-66
Figure 2-25. Relationships Among Solids Output, Dredge Size, and Pipeline Lengths for Various Dredging Depths	2-68
Figure 2-26. Operation of a Cutterhead Dredge	2-69
Figure 2-27. Spider Barge Connected to Hydraulic Pipeline Dredge	2-70
Figure 2-28. Hopper Dredge	2-72
Figure 2-29. Split-Hull Hopper Dredge Unloading Dredged Material	2-76
Figure 2-30. Dustpan Dredge	2-79
Figure 2-31. Dustpan Dredge Operating Configuration	2-80
Figure 2-32. Sidecasting Dredge	2-82
Figure 2-33. Clamshell Bucket Bridge	2-84
Figure 2-34. Hydraulic Unloader	2-85
Figure 2-35. Enclosed Bucket	2-87
Figure 2-36. Backhoe Dredge New York	2-89
Figure 2-37. Dredge Currituck	2-91
Figure 2-38. Water Injection Dredge	2-97
Figure 2-39 Bed-Leveler Suspended by an A-Frame on a Work Barge	2-101
Figure 2-40. Bed-Leveler Suspended from a Work Barge	2-102
Figure 2-41. Bed-Leveler Suspended by an A-Frame on a Work Barge	2-102
Figure 2-42. Production “Smoke” Chart	2-105
Figure 2-43. Nuclear Density Gage	2-106
Figure 2-44. Draft and Hopper Level Sensors	2-109
Figure 2-45. Acoustic Hopper Level Sensor	2-109
Figure 2-46. Example of Louisville District-Required Dredging Parameters	2-111
Figure 2-47. USACE Districts Currently Using DQM	2-112
Figure 2-48. Hopper Dredge Sensors	2-113
Figure 2-49. National Dredging Quality Management (DQM) Program Data Collection	2-114
Figure 2-50. Hopper Dredge DQMOBS Interface	2-117
Figure 2-51. Example of Bathymetry Within the SMS 11.0 Modeling Environment	2-123
Figure 2-52. Map of Bridges Harbor in the Todd-istan Region with SAV (Red), Tropical Salmoid Passage (Yellow), Coral Reef (Blue), and Dredging Region (Green)	2-125
Figure 2-53. Particle Positions Shown for the First, Second, Third, and Seventh Days after Dredging Begins Using a Hopper Dredge with no Overflow	2-126
Figure 2-54. Computational Grid for the Data Analysis Tools	2-127
Figure 2-55. Suspended Sediment Concentration Contours Plotted on the Data Analysis Grid During Day 3	2-128
Figure 2-56. Time Series of Concentration at a Point	2-128
Figure 2-57. Cross Section of Suspended Sediment Concentration Contours	2-129
Figure 2-58. Estimated Annual Distribution of Environmental Windows by Dredging Method (FY 1987-1996; Federal Dredging Contracts Only)	2-136



	<u>Page</u>
Figure 2-59. Mean Annual Number of Federal Dredging Contracts by Dredging Category (FY 1987-1996)	2-137
Figure 2-60. Framework for Determining Environmental Acceptability of Dredged Material Disposal Alternatives	2-142
Figure 2-61. CE-Dredge Dredging Manager Navigation Channels and Disposal Areas Visualization	2-152
Figure 2-62. CE-Dredge Disposal Area and Beneficial User Management	2-152
Figure 2-63. CE-Dredge Dredging Contracts Management	2-153
Figure 2-64. DQM Data Viewer Screenshot of a Coastal Hopper Dredge Project	2-154
Figure 2-65. DQM Data Viewer Screenshot of a Riverine Hopper Dredge Project	2-155
Figure 2-66. Screenshot of a DQM Cumulative Disposal Plot (1)	2-156
Figure 2-67. Screenshot of a DQM Cumulative Disposal Plot (2)	2-157
Figure 2-68. Screenshot of a DQM EPA Report	2-158
Figure 2-69. ADDAMS Applications Categorized into Dredge Material Management and Environmental Effects Evaluation	2-160
Figure 3-1. Major Steps and Components of Open-Water Placement	3-3
Figure 3-2. Schematic of the Behavior of Dredged Material Released in Open Water	3-12
Figure 3-3. Schematic of the Sediment Plume from a Pipeline Discharge in Open Water	3-12
Figure 3-4. Adjusted Thickness (Height) of the Ashtabula, Rochester, and New York Bight Base Surge Data	3-15
Figure 3-5. Concentrations of Suspended Material After the Base Surge in the Great Lakes	3-16
Figure 3-6. Effect of Pipeline Dredge Discharge Angle and Predominant Current Direction on the Shape of a Fluid Mud Mound	3-19
Figure 3-7. Example Plot of Important Marine Resources	3-31
Figure 3-8. General Representation of the Screening Concept for Siting	3-32
Figure 3-9. Overlay Process for Screening Out Sensitive and Incompatible Use Areas	3-32
Figure 3-10. Phases of Ocean Dredged Material Disposal Site Designation Protocol	3-33
Figure 3-11. Potential Contaminant Pathways for Open-Water Disposal	3-38
Figure 3-12. Overview of the ITM Tiered Testing Approach	3-40
Figure 3-13. Overview of the OTM Tiered Testing Approach	3-43
Figure 3-14. Submerged Diffuser	3-47
Figure 3-15. Submerged Diffuser Profile View	3-48
Figure 3-16. Discharge Barge Used to Provide both Support and the Capability for Lowering the Diffuser	3-49
Figure 3-17. Gravity-Fed Downpipe (Tremie)	3-50
Figure 3-18. Contained Aquatic Disposal (CAD) and Level Bottom Capping (LBC)	3-53
Figure 3-19. The Systematic Approach Toward Designing a Monitoring Plan	3-63
Figure 4-1. Illustration of Upland, Near Shore, and Island CDFs	4-1
Figure 4-2. Shelfter CDF in Rotterdam, The Netherlands	4-2
Figure 4-3. Typical Upland CDF	4-3
Figure 4-4. Chicago Nearshore CDF	4-4

	<u>Page</u>
Figure 4-5. Island CDF in Tampa Bay	4-4
Figure 4-6. Typical CDF Hydraulic Inflow from a Cutterhead Pipeline Dredge	4-6
Figure 4-7. Hopper Dredge Pumpout Operation with Pipeline Leading to CDF	4-6
Figure 4-8. Specialized Hydraulic Offloaders	4-7
Figure 4-9. Chute Used for Direct Mechanical Placement into a CDF	4-7
Figure 4-10. Chute Fabricated from Railcar Tanks Used for Direct Mechanical Placement into a CDF	4-8
Figure 4-11. Placement Using a Chute Fabricated from Railcar Tanks Used for Direct Mechanical Placement into a CDF	4-8
Figure 4-12. Technical Framework Flowchart for Evaluation of Confined Dredged Material Disposal	4-12
Figure 4-13. Conceptual Diagram of a Dredged Material Containment Area	4-22
Figure 4-14. Flowchart of the Design Procedure for Settling and Initial Storage	4-24
Figure 4-15. Settling Column Test	4-26
Figure 4-16. Schematic of an Apparatus for conducting Settling Tests	4-27
Figure 4-17. Weir Design Nomograph	4-29
Figure 4-18. Conceptual Illustration of Withdraw Depth and Velocity Profile	4-30
Figure 4-19. Rectangular Weir (1)	4-32
Figure 4-20. Rectangular Weir (2)	4-32
Figure 4-21. Effective Lengths of Various Weir Types	4-33
Figure 4-22. Telescoping Weir at Craney Island	4-34
Figure 4-23. Conceptual Diagram of Dredged Material Consolidation and Dewatering Processes	4-37
Figure 4-24. Dredged Material Evaporative Efficiency as a Function of Time	4-39
Figure 4-25. Illustrative Time-Consolidation Relationships	4-41
Figure 4-26. Projected Surface Height for Determination of Containment Area Service Life	4-41
Figure 4-27. Projected Storage Capacity for Determination of Containment Area Service Life	4-42
Figure 4-28. Measured and Predicted Material Heights at Drum Island	4-45
Figure 4-29. Measured and Predicted Material Heights at Craney Island	4-45
Figure 4-30. Surface of Fine-Grained Dredged Material at the Earliest Time when Surface Trenching Should be Attempted	4-48
Figure 4-31. Shallow Initial Perimeter Trench Constructed by Dragline Operating from the Perimeter Dike	4-50
Figure 4-32. A Small Dragline on Mats, Working on a Berm, Deepens a Shallow Perimeter Trench	4-51
Figure 4-33. Construction of a Ditch 30-45 cm (12-18 in.) Deep with Excavated Material Cast on the Interior Slope of a Perimeter Dike	4-51
Figure 4-34. Desiccation Crust Adjacent to the Perimeter of a 1-1.5 m (3-5 ft) Deep Drainage Trench	4-52
Figure 4-35. A Well-Developed Perimeter Trenching System, Morris Island Disposal Site, Charleston District	4-52

	<u>Page</u>
Figure 4-36. Desiccation Crust Achieved in Highly Plastic Clay Dredged Material 180 m (200 yd) into a Disposal Area by Perimeter Trenching over a 12-Month Period	4-53
Figure 4-37. Rubber-Tired Rotary Trencher	4-55
Figure 4-38. Track-Mounted Rotary Trencher Used in Mosquito-Control Activities	4-55
Figure 4-39. Hemispherical Rotary Trenching Implement	4-56
Figure 4-40. Trapezoidal Rotary Trenching Implement	4-56
Figure 4-41. Rotary Trenching Device in Operation	4-57
Figure 4-42. General View of Trenches Formed by a Rotary Trencher	4-57
Figure 4-43. Close-Up View of Trenches Formed by a Rotary Trencher	4-58
Figure 4-44. General View of a Confined Disposal Area Showing Parallel Trenches in Place	4-58
Figure 4-45. Combination Radial-Parallel Trenching Scheme	4-59
Figure 4-46. Aerial View of Sequential Radial Trenching Procedure Used when Interior Cross Dikes are Encountered, South Blakely Island Disposal Site, Mobile District	4-61
Figure 4-47. Examples of Cross and Spur Dikes	4-64
Figure 4-48. Rotational Failure in a Dike	4-72
Figure 4-49. Translatory Failure in a Dike	4-72
Figure 4-50. Rotational Failure in both a Dike and its Foundation	4-72
Figure 4-51. Translatory Failure in both a Dike and its Foundation	4-73
Figure 4-52. Basic Methods of Forming Dike Sections for Stability	4-74
Figure 4-53. Seepage Lines Through a Dike	4-75
Figure 4-54. Seepage Entrance Through an Area Excavated Within a Disposal Area	4-75
Figure 4-55. Example of Excessive Uniform Settlement	4-75
Figure 4-56. Differential Settlement from a Foundation Containing Materials of Different Compressibility	4-77
Figure 4-57. Potential Fabric-Reinforced Embankment Failure Modes	4-79
Figure 4-58. Dike Raising Methods	4-80
Figure 4-59. Swagging of a Pipe due to Settlement of the Dike Foundation	4-85
Figure 4-60. Cracking at the Dike-Structure Junction Caused by Differential Settlement Because the Dike Load is much Greater than the Weir Load	4-85
Figure 4-61. Cambered Pipe Beneath a Dike	4-86
Figure 4-62. Cambered and Raised Pipe Beneath a Dike	4-86
Figure 4-63. Annular Drainage Material Around the Outlet One-Third of a Pipe	4-87
Figure 4-64. Contaminant Pathways from Upland CDFs	4-88
Figure 4-65. Contaminant Pathways from Nearshore CDFs	4-89
Figure 4-66. Modified Elutriate Test in Progress	4-93
Figure 4-67. Soil Lysimeter	4-94
Figure 4-68. Batch Leaching Test	4-96
Figure 4-69. Plant Uptake	4-96
Figure 4-70. Animal Uptake	4-97
Figure 4-71. Schematic of Volatile Test Chamber	4-98
Figure 4-72. Granular Media Filtration	4-99
Figure 4-73. Cross Sections of Dike Sections	4-100
Figure 4-74. Process of Treatment of Contaminated Dredged Material	4-109

	<u>Page</u>
Figure 4-75. Conceptual Illustration of a Disposal Site Layout to Permit Parallel Compartment Use and Produce Surface Topography Facilitating Future Dredged Material Dewatering	4-116
Figure 4-76. Conceptual Illustration of Sequential Dewatering Operations	4-117
Figure 4-77. Illustrations of the Method for Estimating Calendar Periods when Evaporation Rates are Maximized	4-119
Figure 4-78. Surface Water Management	4-120
Figure 4-79. Inlet-Weir Management to Provide a Smooth Slope for the Inlet to the Weir	4-122
Figure 4-80. Recommended Boarding Configuration	4-123
Figure 4-81. Relationship of Flow Rate, Weir Length and Head	4-125
Figure 5-1. Range in Permeability and Sorptive Properties of Different Soil Classes	5-5
Figure 5-2. Schematic of a Rehandling System for Hydraulic Pipeline Transport	5-14
Figure 5-3. A Tugboat and Barge Transporting Dredged Material	5-15
Figure 5-4. Truck Haul Used by the Chicago District to Place Dredge Material	5-16
Figure 5-5. A 1 m (3.3 ft) Belt Conveyer Dredged Material Loading Operation	5-17
Figure 5-6. Barge-Loading Operation	5-18
Figure 5-7. Unit Train Rail Loading Facility	5-18
Figure 5-8. Hypothetical Site Illustrating the Potential Diversity of Habitat Types that may be Developed at a Dredged Material Placement Site	5-22
Figure 5-9. A Clapper Rail Running Through the Planted Dredged Material Salt Marsh at Buttermilk Sound, Altamaha River, GA, in 1985	5-23
Figure 5-10. Salt Pond 3 Habitat Development Field Site, South San Francisco Bay, CA, in 1980	5-24
Figure 5-11. Gaillard Island Habitat Development Field Site, Lower Mobile Bay, AL, in 1984	5-26
Figure 5-12. Bolivar Peninsula Habitat Development Field Site, Galveston Bay, TX	5-27
Figure 5-13. Procedural Guidelines for the Selection of Various Habitat Development Alternatives Using Dredged Material	5-31
Figure 5-14. Procedural Guidelines for the Selection of Various Marsh and Wetland Habitat Development Alternatives	5-35
Figure 5-15. Protective Structures for New Substrate	5-40
Figure 5-16. Transplants at Miller Sands Habitat Development Site, Planted on 1 m (3.3 ft) Centers, at the End of the First Growing Season	5-41
Figure 5-17. Sketches of Typical East Coast and Florida Tidal Marshes, Showing Plant Association and Usual Occurrence in the Marshes	5-42
Figure 5-18. Sketches of Typical Pacific Northwest and California Coast Tidal Marshes, Showing Plant Associations and Usual Occurrence in the Marshes	5-42
Figure 5-19. Sketches of Typical Brackish Marshes, Showing Plant Associations and Usual Occurrence in the Marshes	5-43
Figure 5-20. Sketches of Typical Lake or Pond and River Freshwater Marshes, Showing Plant Associations and Usual Occurrence in the Marshes	5-43

	<u>Page</u>
Figure 5-21. Heavy Equipment was Required to Shave Down Sandy Dredged Material Deposits to Intertidal Levels at Bolivar Peninsula, TX, and at Other Man-Made Wetland Sites	5-48
Figure 5-22. Dredged Material Substrate Surface Elevations Versus Time	5-48
Figure 5-23. Erosion-Deposition Criteria for Different Grain Sizes	5-50
Figure 5-24. Retention and Protective Structures	5-51
Figure 5-25. Examples of Typical Slope Failures	5-53
Figure 5-26. Guidelines for Selecting an Upland Habitat Development Alternative	5-65
Figure 5-27. Liming and Mixing Layers of Silty and Sandy Dredged Material at Nott Island Upland Site, Connecticut River, Connecticut, in the 1970s; This Site has been a Nesting Meadow and Songbird Habitat for more than 25 Years	5-66
Figure 5-28. Nott Island Habitat Development Site, Showing the Planted Nesting and Grazing Meadow as it has Appeared Since 1981	5-68
Figure 5-29. A Dredged Material Island in Florida Typical of Those Built in the U.S. Intracoastal Waterway	5-77
Figure 5-30. Endangered Brown Pelicans Nesting on Gaillard Island, Their First Nesting in Alabama in Over 100 Years	5-78
Figure 5-31. Guidelines for Selecting Island Habitat Development	5-79
Figure 5-32. Royal and Sandwich Terns Nesting on Dredged Material Islands in North Carolina, Where Successional Vegetation Stages are Deliberately Set Back with Placement Operations to Maintain Tern Nesting Habitat	5-81
Figure 5-33. Wading Birds—Ibis, Herons, and Egrets—Nesting in a Maritime Forest in North Carolina	5-82
Figure 5-34. Jimmy Wells Island, One of Two Dredged Material Islands Built for Seabird Nesting Habitat by the Wilmington District in Core Sound, NC, in 1977, is a Highly Successful Nesting Site, but it is Eroding and Needs a New Application of Dredged Material	5-84
Figure 5-35. An Addition Built by the Jacksonville District, in Cooperation with the National Audubon Society, to Sunken Island in Hillsborough Bay, FL, During Maintenance Dredging Operations in the 1970s	5-86
Figure 5-36. Removing Plugs of Shoal Grass from an Existing Bed Near Port St. Joe, FL, for Transplanting on a Nearby Dredged Material Site	5-92
Figure 5-37. Temporary Storage for the Shoal Grass Plugs was Provided by Containers of Seawater, which were Transported to the Dredged Material Site by Skiff	5-92
Figure 5-38. A Bareroot Propagule of Eelgrass Ready for Transplantation	5-93
Figure 5-39. A Bareroot Propagule of Turtle Grass is Held in Place with a Long Staple after Being Transplanted on a Sandy Site to Prevent Waves and Currents from Washing it Out	5-93
Figure 5-40. A Beach Nourishment Operation Underway at Mayport, FL	5-97
Figure 5-41. Dredged Material Nesting Beach for Least Terns at Gulfport, MS	5-99
Figure 5-42. A Sea Turtle Hatchling Moving Toward Open Water on a Florida Dredged-Material Beach	5-102
Figure 5-43. Master Plan of Patriots Point Naval and Maritime Museum, Charleston, SC; This Site Continued to Follow its Master Plan in 2000	5-106

	<u>Page</u>
Figure 5-44. This Riverside Recreational Area at Kalawa, WA, was Built on Material Dredged from the Columbia River more than 25 Years ago and is still in Active Use	5-108
Figure 5-45. Decisional Factors to be Considered at the Dredged Material Containment Area Before Applying Dredged Material for Agricultural Purposes	5-112
Figure 5-46. Hay Bales of Common Reed, Used for Cattle Feed, in an Older Dredged Material Placement Site in New Jersey, 1996	5-116
Figure 5-47. Schematic of a Long-Term Agricultural Dredged Material Placement Site	5-117
Figure 5-48. Sweet Corn Growing on Dredged Material Inside a Containment Area	5-121
Figure 5-49. Galveston District Dredged Material Containment Area No. 85, Showing the Shrimp Pond, Internal Levee, and Associated Structures; This Site was Successfully Used for Shrimp Culture for 3 Years in an Experimental Field Test	5-124
Figure 5-50. Two Concepts for Combining Dredged Material Containment and Aquaculture Operations	5-126
Figure 5-51. Schematic Diagram Showing Operational Techniques Used to Reclaim a Surface Mine Tailing with Dredge Material	5-131
Figure 5-52. Cross-Sectional View of the Contour Backfill Technique	5-133
Figure 5-53. Cross-Sectional View of the Georgia V-Ditch Backfill Technique	5-133
Figure 5-54. Schematic of the Slope Reduction Technique	5-134
Figure 5-55. Dredged Material Placement at Aquatic Park, Toronto, Ontario, Canada, in the 1970s; This Site Continues to be Developed as a Recreational and Commercial Area, and it is Heavily Utilized by Citizens and Visitors	5-139
Figure 5-56. Pointe Mouillee, a 1,900 ha CPF for Contaminated Dredged Material in Western Lake Erie, also Serves as a Multipurpose Beneficial Use Site	5-140
Figure 5-57. Batiquitos Lagoon at Carlsbad, CA, in 1977, a Restored Lagoon Using Dredged Material that was the Mitigation Site for Expansion of the Ports of Los Angeles and Long Beach	5-141
Figure 5-58. Coos Bay, OR, Placement Areas that are Being Used for Industrial, Residential, and Agricultural Purposes	5-143
Figure 5-59. Riverlands Wet Prairie and Bottomland Hardwood Restoration Site Using Dredged Material and Innovative Restoration Technology, St. Louis Area on the Illinois/Missouri/Upper Mississippi River Junctures, in 1993	5-144
Figure 5-60. Weaver Bottoms Dredged Material Wetland Restoration Project, Upper Mississippi River, MN	5-144
Figure 5-61. Kenilworth Marsh, Washington, DC	5-145
Figure 5-62. Eastern Neck National Wildlife Refuge, Chesapeake Bay, MD	5-147
Figure 5-63. Aransas National Wildlife Refuge, Freeport, TX	5-148
Figure 5-64. Hart-Miller Island, Chesapeake Bay, MD	5-149
Figure 5-65. Presidents Island-Memphis Harbor Project; This Project has Developed According to the Port of Memphis Master Plan over the past 25 Years	5-152
Figure 5-66. Two Port Facilities—A Container Port Located on the Columbia and a Grain Terminal Located on the Willamette—Were Built on Dredged Material at the Confluence of the Two Rivers in Portland, OR, in the 1970s	5-153
Figure 5-67. The Port of Vicksburg, MS, Constructed on Dredged Material Over 50 Years Ago, is a Thriving International Port of Entry on the Lower Mississippi River	5-153

	<u>Page</u>
Figure 5-68. The Master Plan Used for Construction on Sandy Dredged Material of an Industrial/Residential/Commercial Complex, Including a Marine and Amusement Park and Sea Grass Restoration Projects, at Mission Bay, San Diego, CA	5-155
Figure 5-69. A Large Shopping Mall, Port Center, was Built on Dredged Material at Swan Island on the Columbia River at Portland, OR, Includes Shopping and Commercial Areas, as Well as Low-Rise Office Buildings	5-156
Figure B-1. Relationship Between the Levels of Turbidity Around a Cutterhead and the Dredge Production Rate	B-5
Figure B-2. Near-Surface Measurements for Suspended Solids Concentrations of Various Hopper Dredges	B-8
Figure B-3. Turbidity Measurement of a Cable Arm Bucket	B-13
Figure B-4. Turbidity Measurement of an Enclosed Bucket	B-13
Figure B-5. Turbidity Measurement of a Conventional Bucket	B-13
Figure B-6. Worst-Case Suspended Sediment Fields for each Dredge Type	B-16
Figure C-1. Conceptual Illustration of a Confined Aquatic Disposal (CAD) Pit	C-1
Figure F-1. Current Applications in ADDAMS	F-2
Figure G-1. Plan for Sedimentation Column and Specifications for Settling Column	G-1
Figure G-2. Plans for Top and Bottom Columns	G-2
Figure H-1. Schematic of the Apparatus Used for Settling Tests	H-3
Figure H-2. Conceptual Plot of Interface Height versus Time	H-4
Figure H-3. Conceptual Concentration Profile Diagram	H-6
Figure H-4. Conceptual Time Versus Concentration Plot	H-8
Figure I-1. Flowchart of the Design Procedure for Settling and Initial Storage	I-2
Figure I-2. Relationships Among Solids Output, Dredge Size, and Pipeline Length for Various Dredging Depths	I-3
Figure I-3. Conceptual Time versus Concentration Plot	I-4
Figure I-4. Conceptual Concentration Profile Diagram	I-8
Figure I-5. Conceptual Plot of Solids Removal Versus Time for Slurries Exhibiting Flocculant Settling	I-9
Figure I-6. Conceptual Plot of Supernatant Suspended Solids Concentration versus Time from Column Settling Tests	I-12
Figure I-7. Percent of Initial Concentration versus Depth Profile	I-18
Figure I-8. Time versus Concentration	I-18
Figure I-9. Solids Removal versus Time	I-23
Figure I-10. Weir Design Nomograph	I-25
Figure I-11. Concentration of Settled Solids versus Time	I-28
Figure I-12. Suspended Solids Concentration Profile Diagram	I-30

	<u>Page</u>
Figure I-13. Plot of Supernatant Suspended Solids Concentration versus Time from Column Settling Tests	I-35
Figure J-1. Self-Weight Consolidation Device	J-1
Figure J-2. Large-Strain, Controlled-Rate-of-Strain Test Chamber	J-2
Figure J-3. Oedometer Testing Apparatus	J-3
Figure K-1. Example of a Weir Mixing System	K-4
Figure K-2. Velocity Gradient $G$ Calibration Curves for Jar Test Apparatus	K-5
Figure K-3. Jar Test Report Form	K-9
Figure L-1. Exponential Void Ratio-Effective Stress Relationship Compared to Oedometer Data, 0-12.0 tons/ft <sup>2</sup>	L-2
Figure L-2. Typical Permeability and Coefficients of Consolidation as a Function of Void Ratio	L-4
Figure L-3. Degree of Consolidation as a Function of the Time Factor for Normally Consolidated, Singly Drained Layers by Linear Finite Strain Theory	L-4
Figure L-4. Degree of Consolidation as a Function of the Time Factor for Normally Consolidated, Doubly Drained Layers by Linear Finite Strain Theory	L-5
Figure L-5. Degree of Consolidation as a Function of the Time Factor for Dredged Fill, Singly Drained Layers by Linear Finite Strain Theory	L-5
Figure L-6. Degree of Consolidation as a Function of the Time Factor for Dredged Fill, Doubly Drained Layers by Linear Finite Strain Theory	L-6
Figure L-7. Maximum Depth of Material Desiccated by First-Stage Drying	L-8
Figure L-8. Maximum Depth of Material Desiccated by Second-Stage Drying	L-9
Figure L-9. Relationship Between Void Ratio and Effective Stress, $e$ -log- $\sigma'$ Curve, for Compressible Foundation for Oedometer Testing	L-12
Figure L-10. Permeability and Coefficients of Consolidation as a Function of Void Ratio for a Compressible Foundation	L-12
Figure L-11. Exponential Void Ratio-Effective Stress Relationship Fitted to Oedometer Data	L-16
Figure L-12. Degree of Consolidation as a Function of the Time Factor for Various Initial Conditions by Small Strain Theory	L-17
Figure L-13. Comparison of Consolidation Percentages in the Dredged Fill Layer as a Function of Time	L-19
Figure L-14. Comparison of Settlement Predictions by Small Screen and Linear Finite Strain Theories	L-20
Figure M-1. Schematic of a Simple Liquid Polymer Feed System	M-1
Figure M-2. Schematic of a Single-Tank Liquid Polymer Feed System	M-2
Figure M-3. Schematic of a Two-Tank Liquid Polymer Feed System	M-2
Figure M-4. Frontal View of a Weir	M-5
Figure M-5. Example Weir Mixing System	M-8



	<u>Page</u>
Figure M-6. Example Elevations in Containment Areas During the Dewatering Sequence	M-12
Figure N-1. Average Pan Evaporation, in Centimeters, for the Continental United States for the month of January, Based on Data Taken from 1931-1960	N-1
Figure N-2. Average Pan Evaporation, in Centimeters, for the Continental United States for the month of February, Based on Data Taken from 1931-1960	N-2
Figure N-3. Average Pan Evaporation, in Centimeters, for the Continental United States for the month of March, Based on Data Taken from 1931-1960	N-2
Figure N-4. Average Pan Evaporation, in Centimeters, for the Continental United States for the month of April, Based on Data Taken from 1931-1960	N-3
Figure N-5. Average Pan Evaporation, in Centimeters, for the Continental United States for the month of May, Based on Data Taken from 1931-1960	N-3
Figure N-6. Average Pan Evaporation, in Centimeters, for the Continental United States for the month of June, Based on Data Taken from 1931-1960	N-4
Figure N-7. Average Pan Evaporation, in Centimeters, for the Continental United States for the month of July, Based on Data Taken from 1931-1960	N-4
Figure N-8. Average Pan Evaporation, in Centimeters, for the Continental United States for the month of August, Based on Data Taken from 1931-1960	N-5
Figure N-9. Average Pan Evaporation, in Centimeters, for the Continental United States for the month of September, Based on Data Taken from 1931-1960	N-5
Figure N-10. Average Pan Evaporation, in Centimeters, for the Continental United States for the month of October, Based on Data Taken from 1931-1960	N-6
Figure N-11. Average Pan Evaporation, in Centimeters, for the Continental United States for the month of November, Based on Data Taken from 1931-1960	N-6
Figure N-12. Average Pan Evaporation, in Centimeters, for the Continental United States for the month of December, Based on Data Taken from 1931-1960	N-7
Figure O-1. Relationship Between the RCI Necessary to Ensure Adequate Mobility and the Vehicle Ground Pressure for Single- and Multiple-Pass Operations in Confined Dredged Material Disposal Areas	O-2
Figure O-2. Relationship Between the RCI of the Confined Disposal Area Surface Crust and the Linear Trenching Rate Obtainable by Dragline Equipment	O-3
Figure P-1. A Typical Plot of the Residence Time Distribution for Dredged Material Containment Areas	P-7

EM 1110-2-5025  
31 Jul 15

THIS PAGE INTENTIONALLY LEFT BLANK

## CHAPTER 1

### Introduction

1.1 Purpose. This Engineer Manual (EM) presents a comprehensive summary of the dredging equipment and dredged material placement techniques used by the U.S. Army Corps of Engineers (USACE), and it describes the management and design processes associated with new-work and maintenance dredging related to navigation projects. Guidance is provided on the following dredging topics:

- a. Evaluation and selection of dredging equipment for various materials to be dredged.
- b. Planning, designing, constructing, operating, and managing environmentally acceptable open-water and confined dredged material placement areas for both short- and long-term placement (disposal) needs.
- c. Planning, designing, developing, and managing dredged material for beneficial uses while incorporating ecological concepts and engineering designs with environmental, economical, and social feasibility.

Note: In this document, the terms “placement” and “disposal” are used synonymously to describe dredged material deposition after its removal from the dredging prism.

1.2 Applicability. This manual applies to all USACE Commands having responsibility for administering USACE dredging programs.

1.3 Distribution. This publication is approved for public release; distribution is unlimited.

1.4 References. Required and related publications are listed in Appendix A, “References.”

1.5 Background.

1.5.1 The USACE has been responsible for the development and maintenance of navigable waterways in the United States since 1824 when Congressional authorization was received to remove sandbars and snags from major navigable rivers. Today, the role of the USACE with respect to navigation is to provide safe, reliable, and efficient waterborne transportation systems (channels, harbors, and waterways) for the movement of commerce, national security needs, and recreation (Verna and Pointon 2000). Navigable inland and coastal waterways, ports, and harbors are critical to the United States as a major means of commercial transportation and as an integral part of national defense.

1.5.2 The USACE accomplishes its navigation mission through a combination of capital improvements and the operation and maintenance of existing projects. Capital improvement activities include the planning, design, and construction of new or replacement navigation improvements. These activities are performed for the navigation of shallow-draft and deep-draft vessels on inland waterways and harbors as well as on coastal and lake ports, harbors, and channels. The USACE maintains the navigability of the inland waterways system and of harbors and ports to

support vessel access and to provide non-navigation benefits, including flood control, recreation, commercial development, power generation, and water supplies.

1.5.3 The USACE accomplishes this maintenance of navigable waterways and Federal channels through dredging. Since only a few of the Nation's ports, harbors, and waterways are naturally deep, without dredging, many navigable channels and waterways would be impassable to waterborne cargo and passenger ships. As global economic forces and advanced technologies have increased the demand for larger, faster, and more efficient vessels in the world fleet, periodic maintenance dredging and future deepening and widening of navigation channels are essential to maintain U.S. competitiveness and economic growth.

1.5.4 The USACE navigation program includes dredging for new channel construction and authorized improvements to previously maintained channel dimensions (new work), maintenance of existing channel dimensions, and urgent requirements that arise annually. Construction of new navigation channels involves removal of materials previously undisturbed. Navigation improvements are directed and authorized by congressional legislation or other action. These improvements have included the construction and dredging of waterway channels, anchorages, turning basins, locks and dams, harbor areas, protective jetties, and breakwaters to ensure adequate dimensions for the safe and efficient movement of vessels. Not included within the Federal purview are facilities such as docks, terminal and transfer facilities, berthing areas, and local access channels, which have traditionally been the responsibility of local interests and project beneficiaries. Maintenance dredging involves the periodic removal of naturally recurring deposited bottom sediments such as sand, silt, and clays in existing navigation channels.

1.5.5 The majority of the workload in the USACE annual dredging program is accomplished by the private dredging industry. The remaining work is performed by the USACE federal minimum dredge fleet (Government-owned and -operated dredges). Estimates of the average cubic yardage dredged by USACE District using Government and contractor equipment, categorized by class of work (maintenance and new work), during Fiscal Years (FY) 2008-2012 are presented in Figure 1-1. The average annual quantity of material removed during this period is approximately 212 million yd<sup>3</sup>/152 million m<sup>3</sup>. The average percentage of dredged material per class of work category—maintenance, new work, both maintenance and new work, and beach renourishment—using USACE and contractor dredges is illustrated in Figure 1-2.

1.5.6 Alternatives for the management of dredged material from these navigation projects must be carefully evaluated from the standpoint of environmental acceptability, technical feasibility, and economics. Over 95% of the materials dredged are a clean and viable resource that, if placed in the proper locations, can be put to productive uses. About 60 million yd<sup>3</sup>/46 million m<sup>3</sup> of dredged materials from USACE navigation projects are placed in ocean waters at about 108 sites approved by the U.S. Environmental Protection Agency (USEPA) (Verna and Pointon 2000). The remaining materials are placed in a variety of locations, including uplands and near-shore confined placement facilities, beach sites, and nearshore waters, to create wetlands and riverine sandbars.

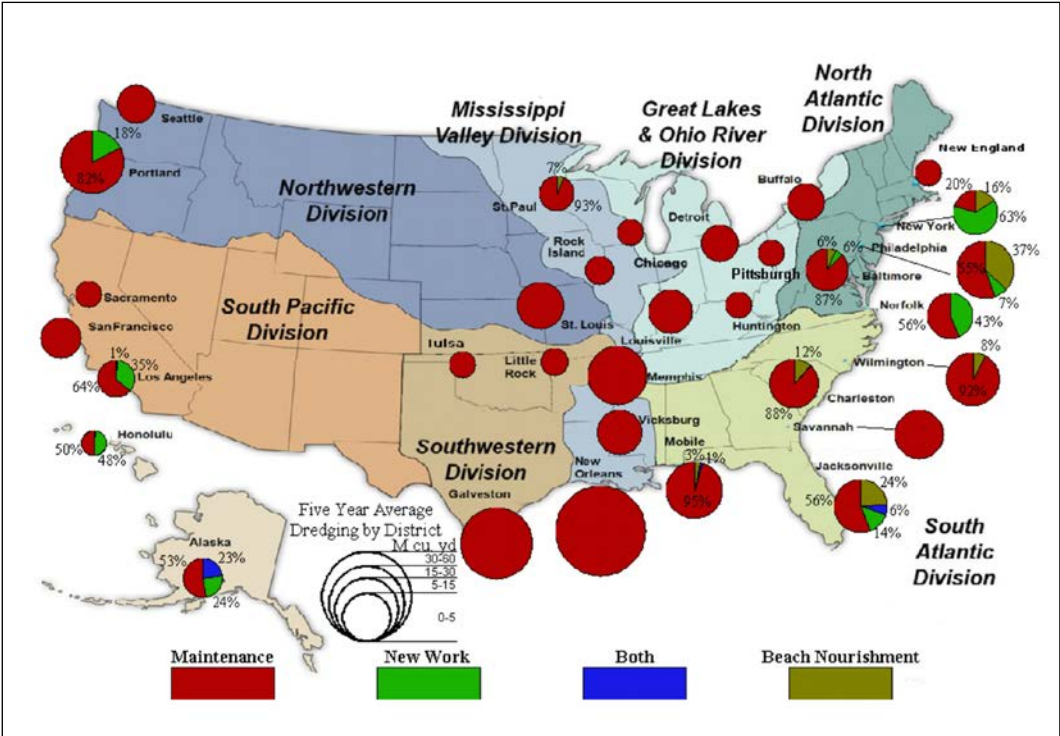

Figure 1-1. USACE Dredging Program—Average Annual Dredging FY 2008-2012, Including both USACE and Contractor Dredging, Broken Down by Location and Class of Work

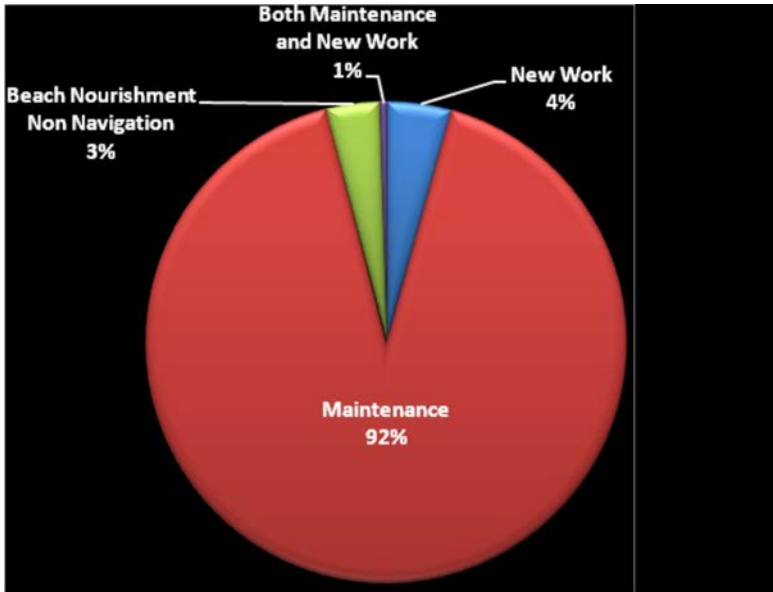

Figure 1-2. USACE Dredging Program—Percentage of Average Annual Yardage of Dredged Material FY 2008-2012, Including both USACE and Contractor Dredging, Broken Down by Class of Work

1.6 Considerations Associated with Dredging and Dredged Material Placement. Engineer Regulation (ER) 1130-2-520 establishes the policy for the operation and maintenance of USACE navigation and dredging projects as well as their related structures and equipment. This regulation directs that dredging shall be accomplished in an efficient, cost-effective, and environmentally acceptable manner to improve and maintain the Nation's waterways to make them suitable for navigation and other purposes consistent with Federal laws and regulations. (See Appendix A, "References" for other navigation/dredging-related publications.) Some considerations associated with dredging and dredged material placement are as follows:

- a. Long-term planning for maintenance dredging projects.
- b. Selection of the proper dredge plant or contractor for a given project.
- c. Control of dredging and placement operation to ensure environmental protection.
- d. Determination of whether contaminated material will be dredged. Contaminated dredged material (or contaminated sediments) are defined as those that have been demonstrated to cause an unacceptable adverse effect on human health or the environment (USEPA/USACE 2004).
- e. Characterization of sediments to be dredged and site-specific conditions to support an engineering design of confined and unconfined placement areas, open-water placement sites, and/or beneficial uses.
- f. Monitoring to determine the levels of suspended solids from dredging operations and placement areas.
- g. Management of containment areas to maximize storage capacity.

## 1.7 Scope.

1.7.1 Chapter 2, "Dredging and Navigation Project Management," describes USACE navigation project dredging management processes and provides a comprehensive summary of the dredging equipment used by the USACE for activities associated with new-work and maintenance projects. This chapter also provides guidance on the evaluation and selection of dredging equipment and presents an overview of environmental impacts from dredging and the evaluation, selection, and management of placement alternatives.

1.7.2 Chapter 3, "Open-Water Placement," describes open-water placement and the major hydrodynamic environments associated with it. Considerations in the selection and use of various types of dredging equipment and techniques for placement are presented, the short- and long-term fates of dredged material in the open-water environment are described, and the methods for quantifying each type are explained. Chapter 3 also discusses the evaluation of contaminant pathways from open-water placement, identifies management and control methods for open-water placement, and addresses considerations for open-water site operation, monitoring, and management.

1.7.3 Chapter 4, “Confined (Diked) Placement,” provides detailed guidance for confined (diked) placement of dredged material in confined disposal facilities (CDFs). In addition, guidance for evaluating site conditions, dike design, retention of dredged material, initial storage requirements during placement, long-term storage capacity, dredged material dewatering, dike design, contaminant pathways and controls, operation and management, and monitoring is presented.

1.7.4 Chapter 5, “Beneficial Uses of Dredged Material,” outlines the wide variety of opportunities for the beneficial use of dredged material and provides a number of case studies. One of the most common beneficial uses for dredged material is as substrate for habitat development. The chapter outlines the important design elements for several habitats, ranging from aquatic to upland. Other beneficial uses of dredged material include agriculture, horticulture, aquaculture, forestry, strip mine reclamation, solid waste landfill, harbor and port development, and fill for many other types of projects. Wherever sediment is needed, dredged material could be the source. Economics generally dictate whether a given beneficial use is feasible. Some guidance for estimating costs is provided as are the engineering properties of dredged material pertinent to the variety of beneficial uses.

## 1.8 Training.

1.8.1 The U.S. Army Engineer Division, Huntsville (USAEDH) offers several dredging-related Proponent-Sponsored Engineer Corps Training (PROSPECT) courses. These courses include Dredging Fundamentals, Dredge Cost Estimating, Hydrographic Survey Techniques, and OMBIL—Applications and Reports.

a. The Dredging Fundamentals course covers fundamental dredging theories and accepted dredging practices through lectures and group discussions. A brief overview of dredge safety, dredge estimating, hydrographic surveying, and dredging contract administration is also provided.

b. The objective of the Dredge Cost Estimating course is to enable the student to develop a detailed, fair, and reasonable cost estimate for maintenance and new-work projects and also to discuss the overall policies and guidance affecting dredge estimates.

c. The Hydrographic Survey Techniques course provides participants with the knowledge and technology required to perform hydrographic surveys in support of USACE navigation, dredging, surveying, coastal engineering, inland waterway, and related marine construction activities. The course is designed to familiarize engineers, engineer technicians, field survey technicians, survey vessel operators, and A-E contract administration personnel with the technical criteria, standards, and specifications in EM 1110-2-1003, Hydrographic Surveying, and show them how to apply these criteria, standards, and specifications to both in-house and contracted hydrographic surveys.

d. The Operations and Management Business Information Link (OMBIL) is a web-based, business information gateway (on the USACE intranet at <https://ombil.usace.army.mil>) which links six major USACE business functional systems (navigation, hydropower, recreation, water supply, environmental stewardship, including natural resources and environmental compliance,

and flood damage reduction) with the U.S. Army Corps of Engineers Financial Management System (CEFMS) for the purpose of data collecting, data management, reporting, and performance measurement. OMBIL—Applications and Reports teaches Operations, Program, and Project Managers in these major business functional areas what information is available in OMBIL and how to access this web-based interface quickly for tracking, monitoring, and viewing information and for use in making management decisions.

Courses and schedules are available at <http://pdsc.usace.army.mil>. Interested USACE employees should check with their Training Officer for details.

1.8.2 The Dredging Operations Technical Support (DOTS) Program, located at the U.S. Army Engineer Research and Development Center (ERDC), offers online training at <http://el.ercd.usace.army.mil/dots/training.html>. Dredging-related courses are added to this website and updated regularly (for example, Dredged Material Assessment and Management and the EPA/Corps Environmental Dredging Short Course).

## 1.9 Related Publications.

1.9.1 In addition to the references cited in Appendix A, “References,” searches for other publications related to environmental effects of dredging and dredged material placement projects may be conducted on the DOTS Environmental Effects and Dredging and Disposal (E2-D2) literature database (<http://el.ercd.usace.army.mil/e2d2/index.html>). In addition, DOTS (<http://el.ercd.usace.army.mil/dots>) provides direct environmental and engineering technical support to the USACE Operations and Maintenance (O&M) dredging mission. Technology transfer activities have supported diverse field needs for years and have directly benefited O&M dredging operations throughout the United States. E2-D2 is a searchable publications reference database containing reports, journal articles, conference proceedings, and publications available from worldwide sources. These technical references cover a diverse range of topics related to the environmental effects of dredging and dredged material placement projects. The database focuses on broad subject areas, such as the beneficial uses of dredged material, contaminated sediments, and the effects of sediment resuspension and sedimentation on aquatic organisms and their habitats. Much of the technical literature pertaining to dredging and dredged material placement is found in the “gray” literature, non-peer-reviewed Federal or State agency publications or proceedings of symposia and specialty conferences. Many other studies of dredging operations are documented in the form of unpublished contract reports, which are frequently held in project files rather than libraries or archives. The database is updated continually and contains nearly 4,000 references, including many abstracts.

1.9.2 Access to publications from various past and current USACE research programs—Dredged Material Research Program (DMRP), Dredging Research Program (DRP), Field Verification Program (FVP), Dredging Operations and Environmental Research (DOER), and Long-Term Effects of Dredging Operations (LEDO)—are available from the DOTS site.

1.9.3 The Dredging Operations and Environmental Research (DOER) Program (<http://el.ercd.usace.army.mil/dots/doer/doer.html>) is an ongoing program that supports the U.S. Army Corps of Engineers Operation and Maintenance Navigation Program. Research is



designed to balance operational and environmental initiatives and to meet complex economic, engineering, and environmental challenges of dredging and placement in support of the navigation mission. Research results will provide dredging project managers with technology for cost-effective operation, evaluation of risks associated with management alternatives, and environmental compliance.

1.9.4 The Dredging Innovations Group (DIG) addresses high-priority dredging-related needs of both the USACE Navigation Business Line and other Civil Works mission areas that involve dredging. The DIG strategically complements the DOER and DOTS programs. It engages USACE District interests in concert with DOTS and leverages ERDC R&D Program products to provide technical support capabilities and to develop/deploy innovative solutions with a focus on improving channel availability, optimizing dredge fleet utilization, reducing dredging unit costs, and strengthening workforce capabilities.

1.9.5 The Navigation Gateway (<http://operations.usace.army.mil/navigation.cfm>) is the USACE Navigation Community of Practice (CoP) place to share navigation-related information among navigation stakeholders (such as the USACE, industry, and academia). This site includes a wide range of types of information including, but not limited to, navigation community headlines, important news items, navigation management tools, and quick links to navigation-relevant aspects (for example, dredging databases, dredging policy and procedures on raising the flag, and USACE navigation R&D programs).

1.10 Explanation of Abbreviations. Abbreviations used in this Engineer Manual (EM) are listed in the Glossary.

1.11 Metrics. The use of both International System of Units (SI) and non-SI units of measurement in this manual is predicated on the common use of both systems in engineering practice and the exclusive use of non-SI units by the navigation industry. In the USACE, water depths are typically expressed in feet; accuracy standards are also expressed in feet. Distances are measured in either meters or feet; however, accuracy standards are expressed in meters. Engineering project coordinates are normally in non-SI units (feet). Construction measurement quantities are normally measured in linear feet, square feet, or cubic yards; however, some recent construction plans and specifications use metric units of measure. Due to the variety of mixed measurements, equivalent conversions have been provided in some instances to promote USACE translation from non-SI units to SI units, but the most common measurement unit is usually used for example computations.

1.12 Appendices. The following appendices are included in this Engineer Manual.

1.12.1 Glossary lists the abbreviations used in the EM.

1.12.2 Appendix A lists references cited in this EM.

1.12.3 Appendix B presents environmental considerations associated with the excavation and placement processes of different types of dredges. Biological considerations of dredging include suspended sediments, sedimentation, chemical release, dissolved oxygen reduction,

channel blockage, and entrainment. Equipment to control, or mitigate, impacts at the excavation (as opposed to placement) site are also described.

1.12.4 Appendix C presents guidance on Confined Aquatic Disposal (CAD) of dredged material with regard to site selection and evaluation, design, construction, operations, cap material and design, and monitoring.

1.12.5 Appendix D lists plant materials for beneficial use sites.

1.12.6 Appendix E identifies the common and scientific names of plants and animals mentioned in this EM.

1.12.7 Appendix F describes the current capabilities and availability of the Automated Dredging and Disposal Alternative Modeling System (ADDAMS).

1.12.8 Appendix G contains figures showing plans and specifications for settling columns.

1.12.9 Appendix H presents test procedures for settling column use.

1.12.10 Appendix I presents the procedures for designing a Confined Disposal Facility (CDF) for suspended solids retention and initial storage volume.

1.12.11 Appendix J describes methods of consolidation testing, recommended oedometer test procedures for dredged material, and test data interpretation.

1.12.12 Appendix K describes jar test procedures for chemical clarification. In

1.12.13 Appendix L describes the technique for estimating consolidation by finite strain techniques. Also in this appendix, the practical problem of a single dredged fill layer deposited on a compressible foundation is solved for settlement as a function of time by both small strain and linear finite strain theories.

1.12.14 Appendix M presents procedure and example calculations for the design of a chemical clarification system.

1.12.15 Appendix N provides the monthly standard class A pan evaporation (averages) for the continental United States.

1.12.16 Appendix O describes procedures for selecting equipment for dewatering operations.

1.12.17 Appendix P provides a dye tracer technique to estimate mean residence time and hydraulic efficiency for containment area design for the retention of solids.

## CHAPTER 2

### Dredging and Navigation Project Management

**2.1 Purpose.** This chapter presents an overview of USACE dredging relevant to navigation project management processes, describes project site characterization methods, and provides a comprehensive summary of the dredging equipment used for activities associated with new work and maintenance projects. Guidance on the evaluation and selection of dredging equipment is provided, and environmental considerations associated with dredging are discussed. An overview of the evaluation, selection, and management of dredged material placement alternatives is also presented.

#### Section I

#### Overview of Dredging and Navigation Project Management

**2.2 Introduction.** The USACE is the Federal government's largest water resources development and management agency. Its water resources program began in 1824 when Congress first appropriated money for improving river navigation. The extensive water resource responsibilities of the USACE require the project planning, authorization process, and operations and maintenance activities to be thorough and well documented. There are established processes, subject to change and modification through legislative and executive action, to safeguard these responsibilities. This paragraph presents overviews of the project formulation (planning, authorization, and implementation) process; regulatory and national policy aspects for Federal navigation projects; Long-Term Management Strategy Concept of dredged material placement and Dredged Material Management Plans; USACE dredging policy; and dredge operation safety.

#### 2.3 Federal Navigation Project Formulation.

2.3.1 The primary Federal objective of water resources planning for navigation improvements is to contribute to national economic development consistent with protecting the Nation's environment and pursuant to national environmental statutes, applicable Executive orders, and other Federal planning requirements. Development of USACE navigation projects consists of three primary elements, which are common to all USACE water resources projects:

- a. Investigations and studies.
- b. Authorization.
- c. Project implementation.

2.3.2 These elements are implemented by the six steps to a civil works project, as outlined in ER 1105-2-100 (Planning Guidance Notebook):

- a. Problem Perception.
- b. Request for Federal Assistance.

- c. Study Problem and Report Preparation.
- d. Report Review and Approval.
- e. Congressional Authorization.
- f. Project Implementation.

2.3.3 Public Law 99-662, the Water Resources Development Act of 1986 (WRDA 1986), signed into law on November 17, 1986, comprehensively reestablished and redefined the Federal interest in water resources development. The major steps in developing water resources are described in detail at [http://publications.usace.army.mil/publications/eng-regs/ER\\_1105-2-100/toc.htm](http://publications.usace.army.mil/publications/eng-regs/ER_1105-2-100/toc.htm).

## 2.4 Federal Legislation.

2.4.1 A number of Federal environmental Executive Orders, regulations, and Federal statutes control dredging and placement operations. The General Survey Act of 1824 directed the USACE to develop and improve harbors and navigation, and Section 10 of the Rivers and Harbors Act of 1899 required the USACE to issue permits for any work in navigable waters. Dredging and placement operations were considered more fully by Congress in the major environmental statutes passed after 1969.

2.4.2 USACE activities in the areas of dredging and dredged material placement, including regulatory actions, come under the jurisdiction of the National Environmental Policy Act (NEPA). Regulation of dredged material placement within both the waters of the United States and ocean waters is a complex issue and is a shared responsibility of the USEPA (<http://www.epa.gov/>) and the USACE (<http://www.usace.army.mil/>). The primary Federal environmental statute governing transportation and ocean placement of dredged material is the Marine Protection, Research, and Sanctuaries Act (MPRSA), also called the Ocean Dumping Act, Public Law 92-532. The primary Federal environmental statute governing the discharge of dredged or fill material into waters of the United States (inland and including the territorial sea) is the Federal Water Pollution Control Act Amendments of 1972, also called the Clean Water Act (CWA), 33 U.S. Code §1251. Additional guidance is provided by the Coastal Zone Management Act of 1972 and the subsequent eight amendments (Public Law 92-583, 16 USC 1451-1456). All proposed dredged material placement activities regulated by the MPRSA and CWA must also comply with the applicable requirements of the NEPA and its implementing regulations. In addition to the MPRSA, CWA, and NEPA, a number of other Federal laws, Executive Orders, etc., must be considered in the evaluation of dredging projects, as previously mentioned. A brief discussion of the major environmental statutes is presented in “Evaluating Environmental Effects of Dredged Material Management Alternatives—A Technical Framework” (the “Technical Framework”) (USEPA/USACE 1992) (revised 2004) at <http://el.erdc.usace.army.mil/dots/guidance.html>. Overviews of the NEPA, MPRSA, and CWA (from the Technical Framework) are presented below.

#### 2.4.2.1 Overview of the National Environmental Policy Act (NEPA) of 1969.

a. The NEPA ([Public Law No. 91-190] [42 USC 4321 et seq.]) applies to major Federal actions (for example, proposals, permits, and legislation) that may significantly affect the environment. USACE activities in the areas of dredging and dredged material placement, including regulatory actions, come under NEPA jurisdiction. It is through the NEPA process that the dredged material placement alternatives—including no action, open-water placement, and confined placement of dredged material—are evaluated, documented, and publicly disclosed. A flowchart illustrating the NEPA process as it is applied to dredging projects is shown in Figure 2-1.

b. The NEPA requires that Government use all practicable means, consistent with the act and other essential considerations of national policy, to fulfill the requirements of the act. This requirement specifically applies to Federal agencies: their plans, regulations, programs, and facilities. The process that has been established under the guidelines of the NEPA helps public officials make decisions based on an understanding of the environmental consequences and take actions that protect, restore, and enhance the environment. The public disclosure document in this process is a report that provides information about the environmental impact of the proposed action. This document is either an Environmental Impact Statement (EIS) or an Environmental Assessment (EA)/Finding of No Significant Impact (FONSI).

c. Existing Federal navigation projects and existing permits have an environmental evaluation accomplished at some time in their history. Evaluation of environmental acceptability of an alternative is done in the NEPA compliance documents, in the Section 404 or Section 103 evaluations and the Public Notice and, to some extent, in the engineering or project reports. Existing project and permit reevaluations normally require a comparison between what is to be done and the existing NEPA document. If the alternative is to remain the same or if it was discussed in detail in the NEPA document and there is no reason to believe any new significant issues or information have been raised since the issuance of the NEPA document, then no additional NEPA coverage is warranted.

d. If, however, there are any new significant issues (such as new placement options not addressed in the EIS/EA), public interest concerns, or reasons to believe significant new contaminants are present, then NEPA requirements should be updated with either an EA/FONSI or a supplement to the existing EIS. In all cases, whether or not additional NEPA documentation is required, all other environmental laws and regulations must be followed. (See Appendix A in the “Technical Framework” for a discussion of necessary compliance.) This is done either in the compliance and coordination section of the EA/EIS (in which case the Section 404 or Section 103 evaluation should be appended to and discussed in the NEPA document) or in the Section 404 or Section 103 evaluations themselves. In either case, there is full public disclosure of the information in the public review process for the NEPA or in the Public Notice for the Section 404/103 evaluation process as well as an opportunity for public comment prior to selection of the preferred alternative.

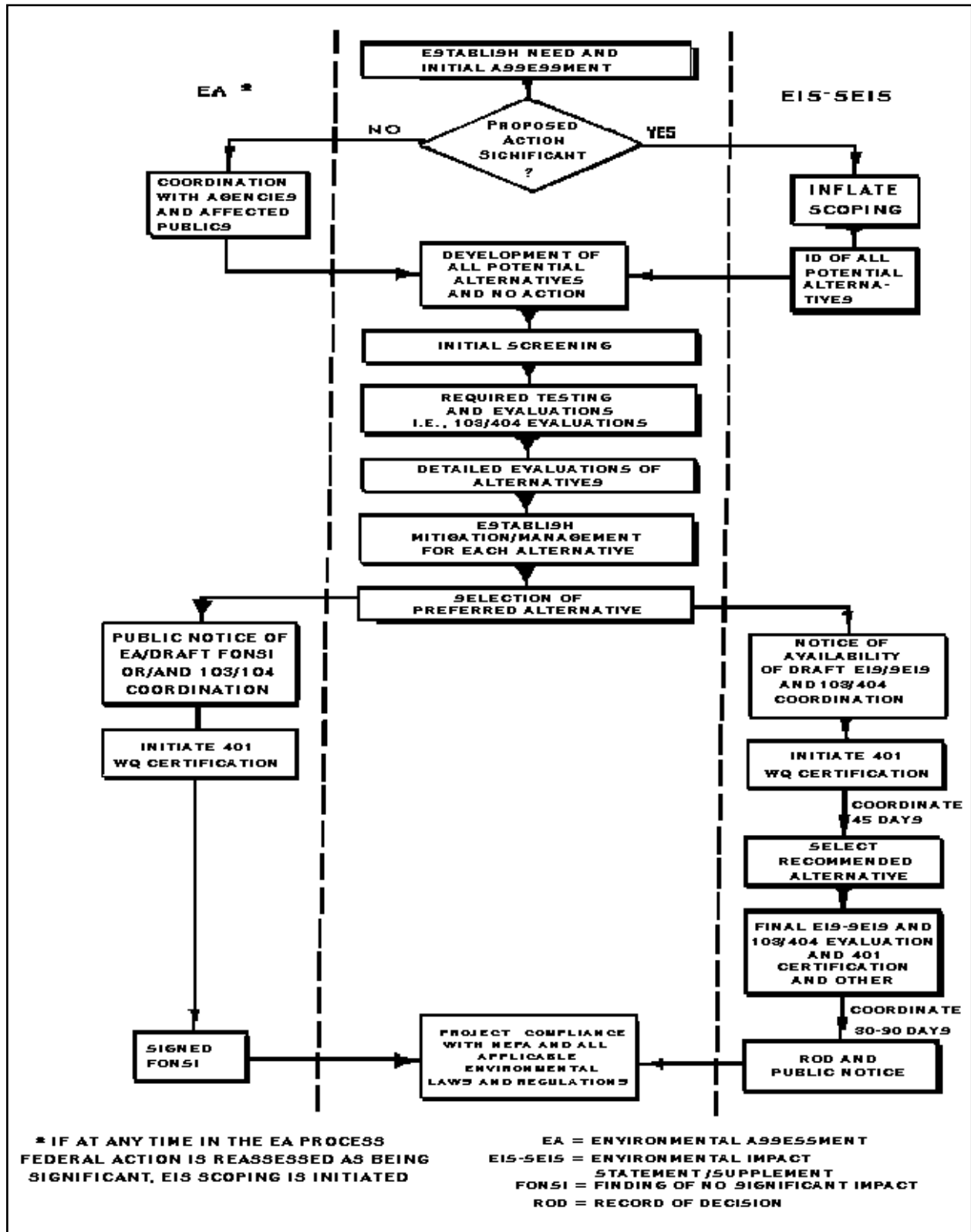

Figure 2-1. NEPA Process for Dredging and Dredged Material Placement Projects (USEPA/USACE 2004)

e. Federal navigation projects involving new work (that is, new channels or improvements to existing channels) and new Section 404/103 permit applications normally have not complied with the NEPA and, therefore, require compliance with the Council on Environmental Quality regulations for implementing the NEPA. This must be initiated as early in the evaluation process as possible. For a more detailed discussion of the USACE regulations implementing the NEPA, refer to 33 Code of Federal Regulations (CFR) Parts 230 and 325.

2.4.2.2 Overview of the MPRSA. Section 102 of the MPRSA requires the USEPA, in consultation with the USACE, to develop environmental Criteria (in the “Technical Framework” these Criteria refer to criteria developed by the USEPA under Section 102 of the MPRSA relating to the effects of the proposed disposal) that must be complied with before any proposed ocean-disposal activity is allowed to proceed. Section 103 of the MPRSA assigns to the USACE the specific responsibility for authorizing the ocean disposal of dredged material. In evaluating proposed ocean-disposal activities, the USACE is required to apply the Criteria developed by the USEPA relating to the effects of the proposed disposal activity. In addition, in reviewing permit applications, the USACE is required to consider navigation, economic and industrial development, and foreign and domestic commerce, as well as the availability of alternatives to ocean disposal. The USEPA has a major environmental oversight role in reviewing the USACE determination of compliance with the ocean-disposal Criteria relating to the effects of the proposed placement. If the USEPA determines ocean-disposal Criteria are not met, placement may not occur without a waiver of the Criteria by the USEPA (40 CFR 225.2[e]). In addition, the USEPA has authority under Section 102 to designate ocean-placement sites. The USACE is required to use such sites for ocean placement to the extent feasible. Section 103 does, however, authorize the USACE, where use of a USEPA-designated site is not feasible or a site has not been designated by the USEPA, to select ocean-placement sites for project(s)-specific use. In exercising this authority, the USACE utilizes USEPA site-selection criteria (40 CFR 228), and the site selection is subject to USEPA review as part of its permit review responsibilities.

2.4.2.3 Overview of the CWA. Section 404 of the CWA requires the USEPA, in conjunction with the USACE, to promulgate Guidelines (in the “Technical Framework,” Guidelines refer to the CWA Section 404(b)(1) Guidelines) for the discharge of dredged or fill material to ensure that such proposed discharge will not result in unacceptable adverse environmental impacts to waters of the United States. Section 404 assigns to the USACE the responsibility for authorizing all such proposed discharges, and requires application of the Guidelines in assessing the environmental acceptability of the proposed action. Under the Guidelines, the USACE is also required to examine practicable alternatives to the proposed discharge, including alternatives to placement in waters of the United States and alternatives with potentially less damaging consequences. The USACE and the USEPA also have authority under Section 230.80 to identify, in advance, sites that are either suitable or unsuitable for the discharge of dredged or fill material in waters of the United States. The USEPA is responsible for general environmental oversight under Section 404 and, pursuant to Section 404(c), retains permit veto authority. In addition, Section 401 provides the States a certification role as to project compliance with applicable State water quality standards.

2.4.2.4 Jurisdiction of the MPRSA and CWA. The geographical jurisdictions of the MPRSA and CWA are indicated in Figure 2-2. As shown in the figure, an overlap of jurisdiction exists within the territorial sea. The precedence of the MPRSA or CWA in the area of the territorial sea is defined in 40 CFR 230.2(b) and 33 CFR 336.0(b). Material dredged from waters of the United States and placed in the territorial sea is evaluated under the MPRSA. In general, dredged material discharged as fill (for example, beach nourishment, island creation, or underwater berms) and placed within the territorial sea is evaluated under the CWA.

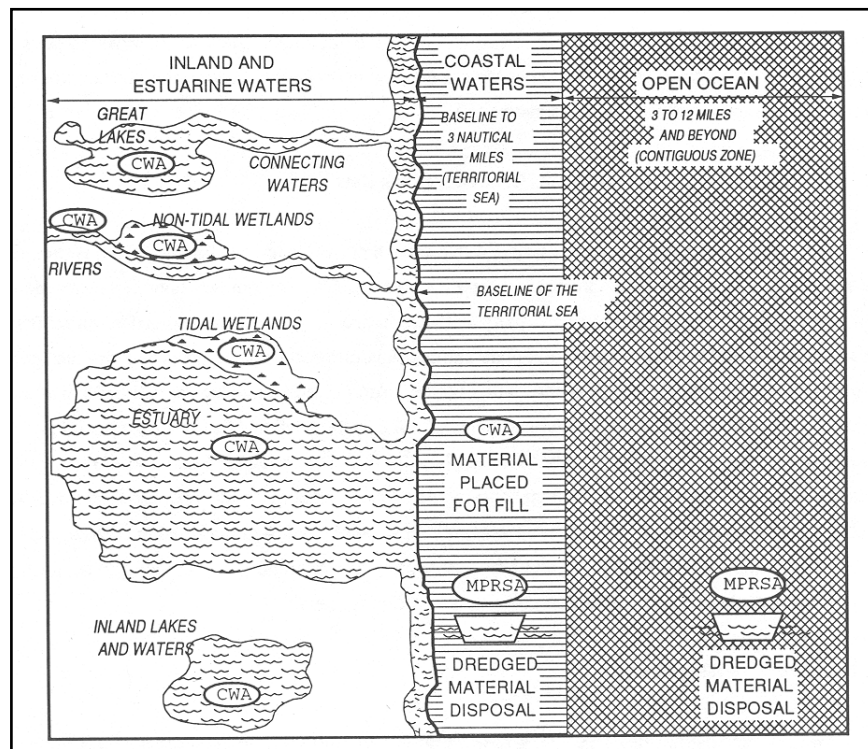

Figure 2-2. Geographical Jurisdictions of the MPRSA and CWA

## 2.5 National Dredging Policy.

2.5.1 Recognizing the important role ports play in the United States economy, defense, and environment, the U.S. President, on August 13, 1993, acknowledged that the existing process for dredging and maintaining the Nation's ports sometimes did not work as well as it could. As a result, the Secretary of Transportation convened the Interagency Working Group on the Dredging Process in October 1993 to investigate and recommend actions to improve the dredging project review process.

2.5.1.1 The Working Group (consisting of personnel from the U.S. Department of Transportation [USDOT], USACE, USEPA, U.S. Fish and Wildlife Service [USFWS], and National Oceanic and Atmospheric Administration [NOAA]) had two major objectives:

- a. Promote greater certainty and predictability in the dredging project review process and dredged material management.



b. Facilitate effective long-term management strategies for addressing dredging and placement needs at both the National and local levels.

2.5.1.2 In December 1994 the Working Group delivered to the Secretary of Transportation, a report entitled “The Dredging Process in the United States: An Action Plan for Improvement,” (U.S. Department of Transportation 1994) (the “Report”), which contained recommendations and a proposed National Dredging Policy. The President endorsed the National Dredging Policy on June 22, 1995, and directed the Federal agencies to implement the Report’s recommendations. The following findings and principles from the U.S. Department of Transportation (1994) were adopted by the President as the National Dredging Policy.

The findings are as follows:

a. A network of ports and harbors is essential to the United States’ economy, affecting its competitiveness in world trade and national security. Port facilities serve as a key link in the intermodal transportation chain and can realize their full potential as magnets for shipping and commerce only if dredging occurs in a timely and cost-effective manner.

b. The nation’s coastal, ocean, and freshwater resources are critical assets, which must be protected, conserved, and restored. These resources are equally important to the United States by providing numerous economic and environmental benefits.

c. Consistent and integrated application of existing environmental statutes can protect the environment and can allow for sustainable economic growth.

d. Close coordination and planning at all governmental levels, and with all aspects of the private sector, are essential to developing and maintaining the Nation’s ports and harbors in a manner that will increase economic growth and protect, conserve, and restore coastal resources.

e. Planning for the development and maintenance of the Nation’s ports and harbors should occur in the context of broad transportation and environmental planning efforts, such as the National Transportation System and the ecosystem/watershed management approach.

The principles are as follows:

a. The regulatory process must be timely, efficient, and predictable, to the maximum extent practicable.

b. Advance dredged material management planning must be conducted on a port or regional scale by a partnership that includes the Federal government, the port authorities, state and local governments, natural resource agencies, public interest groups, the maritime industry, and private citizens. To be effective, this planning must be done before individual Federal or non-Federal dredging project proponents seek individual project approval.

c. Dredged material managers must become more involved in watershed planning to emphasize the importance of point and non-point source pollution controls in reducing harbor sediment contamination.

31 Jul 15

d. Dredged material is a resource, and environmentally sound beneficial use of dredged material for such projects as wetland creation, beach nourishment, and development projects must be encouraged.

2.5.2 One of the major areas that the Report identified as needing improvement was in planning mechanisms for dredging and dredged material management. The Report concluded the following:

a. The dredging project review process often uses an ad hoc planning process, resulting in a piecemeal rather than an integrated planning approach.

b. A planning process needs to be put in place that addresses individual port development, regional and national economic development, and appropriate management of the environmental effects of dredging and dredged material placement.

2.5.3 Two Report recommendations that pertain directly to planning are addressed by guidance provided by the National Dredging Team (1998). More information on the National Dredging Policy is available at <http://water.epa.gov/type/oceb/oceandumping/dredgedmaterial/index.cfm>.

a. Create and/or augment regional/local dredged material planning groups to aid in the development of regional dredged material management plans.

b. Identify the characteristics of successful Federal/State/local partnerships for use in developing dredged material management planning efforts

## 2.6 Long-Term Management Strategy and Dredged Material Management Plans.

2.6.1 Over the past two decades, several factors have developed to create an increasing challenge for the USACE and its partners in operating and maintaining the Nation's harbors, particularly in the area of the management of dredged material. These factors include substantial and continuous increases in the demands of commerce, rapid evolution of shipping practices (containerization and intermodalism), increasing environmental awareness and mounting environmental problems affecting coastal and ocean waters, tight budgetary constraints, heavy population shifts to coastal areas, and generally increased non-Federal responsibilities in the development and management of navigation projects. As a result, management of the Nation's harbor system in general, and of dredged material specifically, has become a controversial problem encompassing all phases of harbor project development and operation, from planning new or larger projects to maintaining existing projects. In response to the problem, there evolved a concept for development of Long-Term Management Strategies (LTMSs) for projects facing serious issues. Dredged Material Management Plans (DMMPs) translate LTMS concepts into explicit dredged material policies and procedures within the broader context of a national harbor program.

2.6.2 Harbor maintenance and development are primary missions of the USACE. These missions contribute directly to national economic development and international trade. Effective accomplishment of these missions usually requires dredging to achieve the navigable dimensions

sufficient to meet the needs of water transportation. By extension, sound management of dredged material is a priority mission of the USACE. The interests of economic development and environmental sustainability are best served when dredged material placement proceeds according to a management plan. Therefore, each harbor maintenance and development project has a plan that ensures warranted and environmentally acceptable maintenance of the project. For many harbors, existing plans are now and will continue to be efficient and environmentally acceptable. For other harbors, historic trends and emerging challenges provide clear indicators that existing plans must be modified to meet future material management needs. Beneficial uses of dredged material are powerful tools for harmonizing environmental values and navigation projects. The USACE will include in all dredged material management studies an assessment of potential beneficial uses for environmental purposes, including fish and wildlife habitat creation and restoration and/or hurricane and storm damage reduction. Exceptions to this principle arise when emerging material management problems and solutions represent changes of such significance that a policy-level commitment is required. Examples are changes in dredged material management practices requiring substantial capital investment or large increases in annual maintenance expenditures.

### 2.6.3 Long-Term Management Strategy (LTMS).

2.6.3.1 As early as 1978, the USACE Dredge Material Research Program (DMRP) concluded that not only would long-term dredged material management plans offer greater opportunities for environmental protection at reduced project costs, but also dredged material placement activities would meet with greater public acceptance once they were adopted and implemented. The Director of Civil Works endorsed the concept in 1996. In 1997, a workshop attended by USACE personnel was held to discuss the LTMS concept. At this workshop, it was concluded that applying this concept to dredged material placement resulting from channel maintenance was viable and should be implemented. The LTMS concept has since been endorsed by the Chief of Engineers' Environmental Advisory Board as an effective method of managing dredged material placement associated with the USACE navigation program.

2.6.3.2 The LTMS concept is a systematic approach to developing short- and long-term solutions and strategies for the placement of dredged material and to investigating measures to reduce dredging quantities. Developing and implementing an LTMS for dredged material placement is an orderly, sequential process. It establishes the projected dredging needs and identifies potential alternative dredged material placement sites. This results in the development of a Long-Term Management Plan that sets out procedural and administrative objectives for implementation. The process provides for the periodic review and updating of the Long-Term Management Plan to maintain a viable, long-term dredged material placement plan.

2.6.3.3 A sequential process of developing and implementing an LTMS for dredged material placement for maintenance dredging has been developed by the U.S. Army Engineer Research and Development Center (ERDC) Environmental Laboratory (Francingues and Mathis 1989). It is briefly summarized as follows:

- a. Evaluate Existing Management Options. Estimate the quantity of dredged material to be placed for the site plan. This estimate leads to the needed capacity per dredging event and the total capacity needed for the requirements of the site plan.

b. Formulate Alternatives. Identify dredged material placement site alternatives, and establish the conditions and requirements of each alternative site.

c. Analyze Alternatives in Detail. Make a comparative assessment that weighs and balances impacts and benefits of the alternatives. The purposes are to identify the most practical alternative, or alternatives, and to provide the documentation needed to support selection of the alternatives.

d. Implement Long-Term Management. Obtain the necessary NEPA documentation, permits, easements, and other materials, and prepare the site if necessary.

e. Review and Update: Review the site plan, as required, to assure it remains viable.

2.6.3.4 Revised USACE Dredging Regulations are published in 33 CFR Parts 335-338. Language is included that encourages the USACE Districts to pursue LTMS for dredged material placement. Specifically, Section 337.9(a) states: “District Engineers should identify and develop dredged material placement management strategies that satisfy the long-term (greater than 10 years) needs for Corps of Engineers’ projects.”

2.6.4 DMMPs. DMMPs translate the LTMS concept into explicit dredged material policies and procedures within the broader context of a national harbor program. Dredged material management planning for all Federal harbor projects is conducted by the USACE to ensure that maintenance dredging activities are performed in an environmentally acceptable manner, use sound engineering techniques, and are economically warranted, and that sufficient placement areas are available for at least the next 20 years. These plans address dredging needs, placement capabilities, capacities of placement areas, environmental compliance requirements, potential for beneficial usage of dredged material, and indicators of continued economic justification. DMMPs must be updated periodically to identify any potentially changed conditions (ER 1105-2-100). Additional guidance on DMMPs is provided by the National Dredging Team (1998).

## 2.7 USACE Dredging Policy.

2.7.1 The entire process of dredging navigation project implementation and maintenance requires that the regulatory, planning, engineering, and O&M activities be thorough and well-documented. There are established processes, subject to change and modification through legislative and executive action, that provide guidance to accomplish these requirements (Appendix A, “References,” lists many guidance documents).

2.7.2 The policy governing accomplishment of USACE dredging is established in ER 1130-2-520. This ER states that dredging must be accomplished in an efficient, cost-effective, and environmentally acceptable manner to improve and maintain the Nation’s waterways, making them suitable for navigation and other purposes consistent with Federal laws and regulations. In addition, the maximum practicable benefits are to be obtained from materials dredged from authorized Federal navigation projects, after taking into consideration economics, engineering, and environmental requirements in accordance with applicable Federal laws and regulations (33 CFR Parts 335-338) ([http://www.access.gpo.gov/nara/cfr/waisidx\\_00/33cfrv3\\_00.html](http://www.access.gpo.gov/nara/cfr/waisidx_00/33cfrv3_00.html)). Aspects covered in this ER include the following:

- a. Establishment of channel dimensions and depth.
- b. Allowable overdepth.
- c. Advance maintenance dredging.
- d. Types of dredging contracts.
- e. Contract documents.
- f. Estimates of dredging costs.
- g. Navigation channel conditions.
- h. Placement of dredged material.

## 2.8 Regional Sediment Management.

2.8.1 Regional Sediment Management (RSM) is the approach by the USACE to managing sediment as a resource in the context of the Nation's river and coastal systems. This approach involves the cooperation of USACE engineers, policy makers, and managers along with state representatives, conservationists, harbor, coastal, and port stakeholders as well as the general public.

2.8.2 USACE professionals have met, discussed, implemented, and demonstrated RSM and its benefits throughout the United States. Regional and national stakeholders, other interested individuals from outside USACE, and international audiences at professional meetings have all listened to USACE RSM presentations and accepted the concept. Themes at recent international conferences and workshops, as well as other resources, suggest a worldwide movement to watershed and regional management of sediment. In some ways, RSM may seem to be a concept long practiced within USACE communities; however, new business processes have expanded its scope. RSM also supports USACE's Environmental Operating Principles (<http://www.usace.army.mil/Missions/Environmental/EnvironmentalOperatingPrinciples.aspx>), which bring a holistic perspective to all projects. Managing sediment to benefit a region potentially saves money, allows the use of natural processes to solve engineering problems, and improves the environment.

2.8.3 As a management method, RSM does the following:

- a. Includes the entire environment, from the watershed to the sea
- b. Accounts for the effect of human activities on sediment erosion as well as its transport in streams, lakes, bays, and oceans
- c. Protects and enhances the nation's natural resources while balancing national security and economic needs

2.8.4 USACE holds in trust and manages lands and waterways across the United States. Using regional sediment management concepts significantly improves its mission accomplishment. USACE's engineers and scientists develop new technologies through research to make management decisions more accurate and efficient. Simultaneously, they evaluate RSM concepts through projects that highlight and improve sediment management activities. More information on RSM is available at <http://rsm.usace.army.mil/>

## 2.9 Engineering With Nature.

2.9.1 Engineering With Nature (EWN) is the intentional alignment of natural and engineering processes to efficiently and sustainably deliver economic, environmental, and social benefits.

2.9.2 EWN calls for an ecosystem approach whereby USACE (in collaboration with its partners and stakeholders) seeks to understand and use natural processes in order to achieve a broad range of project objectives within aquatic systems. USACE's EWN strategy enables navigation infrastructure development efforts to provide economic, environmental, and social benefits in a sustainable way, producing a "triple win." By systematically considering the three elements of sustainable development in all USACE projects, from the initiation phase through implementation, USACE will better integrate these into decision making and actions at every phase of a project. The result: more socially acceptable solutions that are more viable and equitable and, ultimately, more sustainable. Figure 2-3 illustrates the win-win-win objective for projects based on the principles of EWN. More detailed information on EWN is available at [www.EngineeringWithNature.org](http://www.EngineeringWithNature.org).



Figure 2-3. Engineering With Nature (EWN)—A Sustainable Approach

## 2.10 Dredge Operation Safety.

2.10.1 The USACE requirements for floating plant and dredge safety are outlined in the Safety and Health Requirements Manual (EM 385-1-1). The roles and responsibilities for both

the USACE and contractor personnel in the administration of the safety program are presented in this EM. It also presents guidance for developing the tools used to administer the program:

a. Accident prevention plan, which is the principal administrative plan, covering the following:

- (1) Safety and health policy.
- (2) Administration and accountability.
- (3) Coordination.
- (4) Training plans.
- (5) Safety inspections.
- (6) Accident investigation and reporting.
- (7) Emergency response procedures.
- (8) Contingency plans for severe weather.
- (9) Job cleanup and safe access.
- (10) Public safety.
- (11) Local requirements.
- (12) Alcohol and drug abuse prevention.
- (13) Hazard communication.

b. Activity hazard analysis, which defines the sequence of work, the specific hazards anticipated, and the control measures to be implemented to eliminate or reduce hazards to an acceptable level.

c. Safety training program details, including supervisor and worker safety meetings.

d. Accident investigations and reporting, including both USACE and Occupational Safety and Health Administration (OSHA) requirements, as necessary.

2.10.2 USACE floating plant safety programs involve coordination with other agencies, such as the OSHA and both local and state safety and worker's compensation departments, but primarily with the U.S. Coast Guard (USCG), which has several responsibilities, including the following:

a. Initial and periodic inspection of specific vital systems—such as firefighting equipment and system installations, life rafts and boats, and emergency power generators—on seagoing vessels.

31 Jul 15

b. Licensing and documentation of seagoing and other personnel, including personnel involved in handling petroleum barges. Licensed and documented personnel are periodically retested to assure they maintain their proficiency.

c. Safety aspects of vessel operations, such as fire, lifeboat, and other drills, or determination of minimum staffing requirements and vessel navigation equipment.

d. Floating plant operators that do not require licensing by the U.S. Coast Guard are licensed and certified by the USACE. In addition, the USACE inspects its own unlicensed vessels and enforces the U.S. Coast Guard regulations for small craft, including life jackets, fire extinguishers, and passenger capacity.

## Section II

### Project Site Characterization

#### 2.11 Background.

2.11.1 An understanding of the physical environments in which the dredging and dredged material placement occur is critical to achieving the USACE policy of accomplishing dredging in an efficient, cost-effective, and environmentally acceptable manner. Planning any dredging operation (which constitutes a specialized problem in earthmoving or excavation) requires field measurements and computations to determine the geotechnical characteristics and quantities of material to be removed as well as an understanding of the site-specific conditions relevant to the planning, design, operation, and maintenance of the dredging and placement sites. Dredged material characteristics (physical, chemical, and engineering) and site-specific conditions of the dredging and placement sites (hydrodynamic regime and foundation conditions, for example) determine both dredge plant and dredged material placement requirements for open-water, confined, and/or beneficial uses alternatives. Regulatory compliance requires that the suitability for the proposed placement of the material to be dredged be characterized and evaluated. This characterization and evaluation may or may not require testing, depending on applicable requirements. Guidance is provided (Tavolaro et al. 2007) to ensure that environmental compliance activities and environmental documentation associated with new Federal navigation project dredging and maintenance dredging adequately consider overdepth dredging.

2.11.2 The “Technical Framework” (USEPA/USACE 2004) presents management alternatives to be used in evaluating the environmental impacts of dredged material placement. This framework provides a technical guide to assess the commonly important factors to be considered in managing dredged material in an environmentally acceptable manner. In the detailed assessment of placement alternatives in “The Technical Framework,” the evaluation of the physical characteristics of the sediment (for example, particle-size distribution, water content or percent solids, specific gravity of solids) is required to determine environmental acceptability. Field investigations provide data for the design of containment areas (for example, volume calculations, evaluation of potential foundation settlement) and open-water placement (for example, dispersive versus nondispersive). Characteristics of dredged material proposed for beneficial use must also be identified to evaluate the suitability of the material for numerous alternative uses.



2.11.3 Both new-work projects and maintenance dredging activities must be consistent with national environmental policies (Section I). In general, these policies require creation and maintenance of conditions under which human activities and natural environments can exist in productive harmony, including preservation of historic and archeological (cultural) resources. Biological, chemical, and/or physical characterization of the dredging and placement sites may be required to ensure national policy compliance.

2.11.4 This section provides guidance on dredging site characterization pertaining to the determination of the following:

- a. Dredged material quantities.
- b. Dredged material geotechnical and chemical characteristics.
- c. Geotechnical characteristics related to the placement site.
- d. The presence of cultural resources and unexploded ordnance.

Information on the determination of site characterization pertaining to placement site parameters—hydrodynamic regime, biological sampling, contaminant pathways, and dredged material engineering properties—is presented in the following chapters of this Engineer Manual: Chapter 3, “Open-Water Placement”; Chapter 4, “Confined (Diked) Placement”; and Chapter 5, “Beneficial Uses of Dredged Material.”

## 2.12 Dredging Locations and Quantities.

2.12.1 Dredging locations and the quantities of material to be dredged are two important considerations in planning navigation dredging projects. Since placement of dredged material is a major consideration, it is essential that long-term projections be made for placement requirements of each project. Records should be kept of quantities dredged and maintenance interval(s) to forecast future dredging and placement requirements (see paragraph 2.6).

2.12.2 Hydrographic surveys are one of the principal dredging contract management tools used by the USACE. Hydrographic surveys should be made before dredging to determine existing depths within the project area and then again after dredging to determine the depths attained as a result of the dredging operation. Each District should have the capability, either in-house or by contract, to make accurate, timely, and repeatable hydrographic surveys. To ensure accuracy, quantity calculations must be made from survey data gathered in a timely manner using proper equipment and based upon precisely established horizontal and vertical controls. Quantity measurement methods must be fully consistent between work performed by contract and work performed by hired labor. EM 1110-2-1003 provides technical guidance for performing hydrographic surveys that support the planning, engineering design, construction, operation, maintenance, and regulation of navigation, flood control, river engineering, charting, and coastal engineering projects. Accuracy standards and quality control criteria are defined to establish USACE-wide uniformity in performing surveys involving dredging measurement, payment, and acceptance. EM 1110-2-1003 should be used as a technical guide in performing hydrographic surveys with USACE hired-labor forces or contracted survey forces. It should be

directly referenced in contract specifications for dredging and Architect-Engineer survey services. The accuracy standards and quality control criteria in the manual should be specified for all surveys supporting dredging measurement, payment, and acceptance functions. Types of dredging templates and surveys are defined, and EM 1110-2-1003 also provides background information concerning dredging contract clauses that deal with measurement and payment surveys. EM 1110-2-1003 may be referenced should hydrographic surveying functions be required as part of a USACE military construction or environmental restoration activity. It is also applicable to surveys performed or procured by local interest groups under various cooperative or cost-sharing agreements. For detailed guidance on dredging procurement policies and practices, refer to ER 1130-2-520, and ER 1110-2-1302.

## 2.13 Dredging Site Geotechnical Investigations.

### 2.13.1 General.

2.13.1.1 The objective of a geotechnical dredging site investigation is to obtain the most complete and accurate estimate of the location and character of the materials to be dredged within the limits of practicality and available time and money. This information must then be communicated in a readily understood manner to all persons involved in the design, planning, cost estimation, and construction of the project. A site investigation for dredging consists of studies of all available existing information that, when necessary, is augmented by geophysical and geotechnical subbottom investigations (including the sampling and testing of sediments and rock). The term “dredged material” refers to material dredged from a water body, while the term “sediment” refers to material in a water body prior to the dredging process. The terms “sediment” and “soil” are used interchangeably in this manual as implied by the American Society for Testing and Materials (ASTM D 653) definition of soil as “sediments or other unconsolidated accumulations of solid particles produced by the physical and chemical disintegration of rocks, which may or may not contain organic matter.” These data are summarized in an estimated geotechnical subbottom profile. The validity of the estimated profile is dependent on the type and amount of site investigation made and on the knowledge and skill of the interpreters of the data.

2.13.1.2 The persons and groups involved in site investigations for dredging operations include geotechnical engineers, geologists, environmental engineers, biologists, estimators, coastal engineers, project engineers, and commercial testing laboratories. These groups have diverse technical backgrounds, and each group has its own internal sediment and rock investigation, description, and classification methodology. Site investigation objectives and strategies within and among these groups differ and often do not convey specific dredging-related information. Testing methods among the various groups also vary. Because of the large sums that will continue to be spent on dredging, there is a need for understanding by all of the participants in a dredging project of the rationale for a site investigation strategy, the objectives of the strategy, and the conventional geotechnical methods for site investigation, sampling, testing, and analysis of data.

2.13.2 Implementing a site investigation strategy. The practical development and implementation of a site investigation strategy for a dredging site involve making decisions to answer the following specific questions (Spigolon 1993):

a. What should be the scope of the investigation?

- (1) Is existing information about the subsurface condition at the site sufficient?
- (2) Will a geophysical exploration be useful?
- (3) Are sampling and/or testing at field exploration sites needed?
- (4) If a field investigation is needed, how many individual exploration sites should be used?
- (5) Where should the exploration sites be located?

b. What should be done at each individual exploration site?

- (1) How many samples and/or field tests should be made in the vertical reach?
- (2) What kind of samples and/or field tests should be made?
- (3) Would a boring or a test pit be used? If a boring, what kind of boring?
- (4) What kind of work platform should be used?
- (5) Which laboratory tests should be made on the samples?
- (6) Will all samples be laboratory tested? If not, which criteria will be used to describe/classify them?

2.13.3 Factors affecting a site investigation strategy. The following factors must be considered in the establishment of the type and magnitude of a geotechnical site investigation:

a. Significant sediment properties. The geotechnical soil properties that must be established for each sediment deposit in the dredging prism to determine dredgeability and placement characteristics. The term “dredgeability” is taken to mean the ability to excavate underwater, remove to the surface, transport, and deposit sediments with respect to known or assumed equipment, methods, and in situ material characteristics. Determination of the sediment placement characteristics is sometimes necessary for predicting the behavior of the dredged material after placement (that is, establishing effective stress/void ratio relationships for calculating consolidation behavior for long-term CDF capacity calculations).

b. Test methods and equipment. The known or assumed capabilities and usefulness of the various appropriate types of geophysical and geotechnical sampling and testing methods and equipment that are available.

c. Site variability. The known or assumed variation in the stratification of the sediments and in their significant dredgeability properties, including both nonrandom trends and random fluctuations about the trends.

d. Magnitude of the sampling and testing program. The effect of the size and type of the sampling and testing program on the estimates of the locations of sediment deposits and their geotechnical characteristics.

e. Value of information. The risks involved in having incomplete information and the savings in total project cost to be expected for each added expenditure of site investigation money (that is, the cost versus the value of additional information).

f. Investigation costs. The costs, both relative and actual, in time and money for the performance of the various available geophysical and geotechnical samples and tests.

g. Investigation flexibility. Whether the plan of the subsurface investigation program is fixed in advance or can be modified as information develops.

h. Principal beneficial use of dredged material anticipated.

#### 2.13.4 Procedure for a geotechnical site investigation.

2.13.4.1 EM 1110-1-1804 establishes criteria and presents guidance for geotechnical investigations during the various stages of development for civil and military projects. The manual is intended to be a guide for planning and conducting geotechnical investigations and not a textbook on engineering geology and soils exploration. Actual investigations—in all instances—must be tailored to the individual projects. Subsurface investigations for dredging projects have requirements that are significantly different from those for the typical foundation engineering project. Geotechnical engineering foundation investigations for structures, either offshore or onshore, generally cover small areas, sometimes to great depths. Existing land-based techniques and equipment are best suited to serve the primary purpose of performing exacting geotechnical field soil tests and obtaining high-quality samples for laboratory shear strength tests. Dredging projects, on the other hand, do not normally require soil strength and texture information with the precision needed for foundation engineering. They do, however, require inferences about the subbottom geotechnical profile over long distances; average values and ranges of values are generally sufficient. Dredging site investigations are similar in scope to those made for highways, canals, and pipelines in the sense that they involve either long, narrow lengths or large areas as well as shallow depths in the soil to be excavated and removed. Maintenance work usually consists of 1 m or less of shoaled material to be removed, and new-work channel deepening projects typically involve 1.5 to 3 m of excavation. New channel projects, however, may involve greater depths of excavation (Spigolon 1993). A geotechnical site investigation for a dredging site must answer several questions:

a. How many sediment and rock deposits are within the proposed dredging prism? Where are they located, and what is their configuration?

b. What kind of material does each deposit consist of? Which geotechnical properties will characterize each deposit? What are the average values and the range in values of each characteristic property?

c. Are the deposits homogeneous or heterogeneous, or do the properties trend in a known, or predictable, manner?

2.13.4.2 The procedure for a typical geotechnical site investigation for a dredging project contains the following steps, as shown in Figure 2-4. The geotechnical factors and site

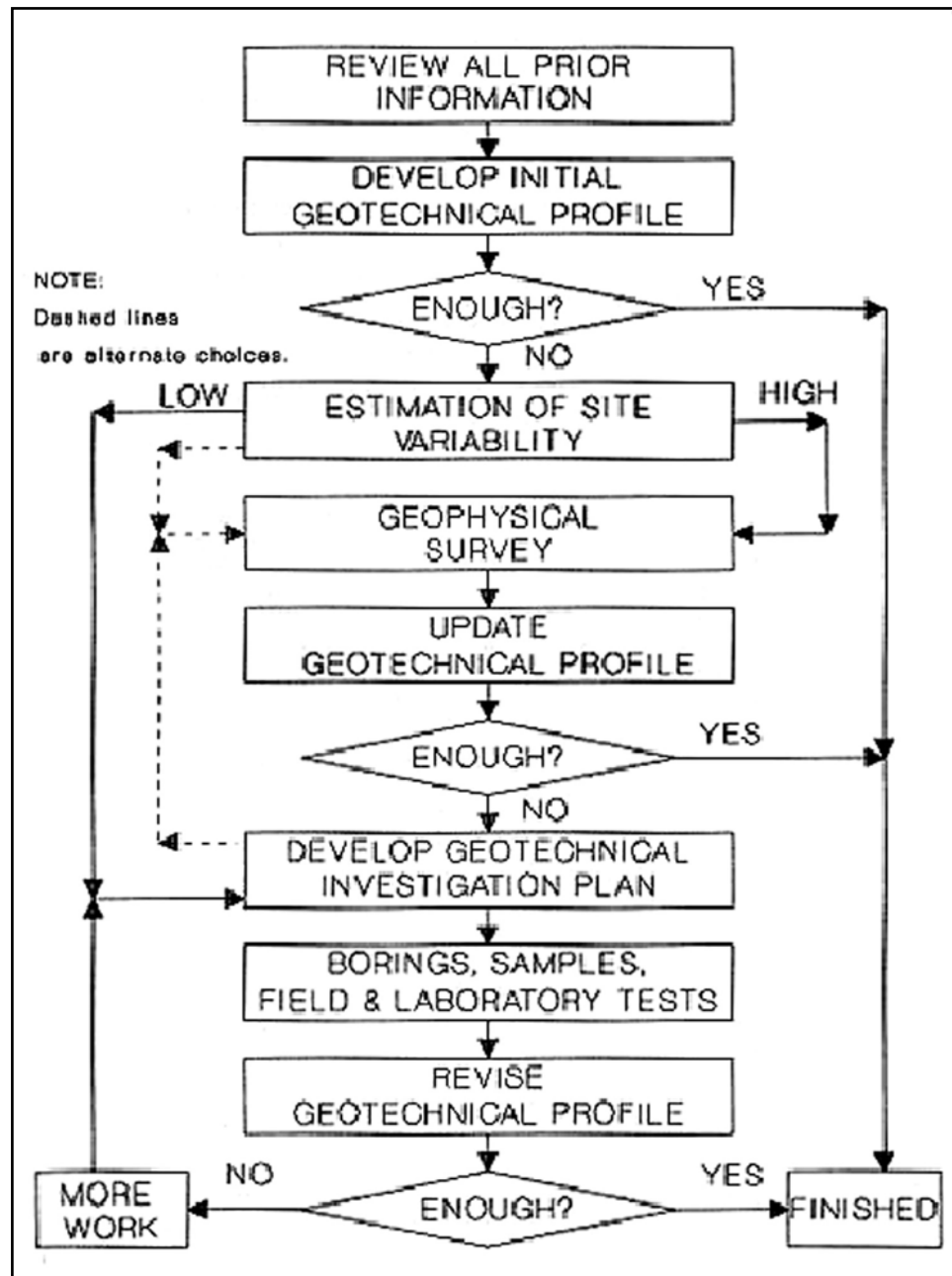

investigation procedure are discussed in detail in Spigolon (1993).

Figure 2-4. Procedure for a Geotechnical Site Investigation (Spigolon 1993)

a. A review is made of all available prior (existing) information—the geologic literature, both published and unpublished, records of previous geotechnical studies in the project area, and personal experiences with soils in the project area. This is sometimes called a desk study.

b. Based on the prior information, an initial hypothesis of the geotechnical subbottom profile is developed, including the types, configuration, and geotechnical character of the subbottom soils present.

c. If the available information is sufficient for the project, the site investigation is terminated at this point. If it is not sufficient, then an estimate is made of site variability. If the site is known, from extensive prior information, to be fairly uniform or to vary in a known manner, a site exploration plan is developed. If the site variability is not well known, then a geophysical survey may be appropriate.

d. Where appropriate, continuous subbottom information is obtained by geophysical studies using acoustic subbottom profiling or another suitable method. The requirements for ground truth sampling and testing for correlation with the data are established.

e. The geophysical data are used to amend the initial hypothesis of the sediment profile. If the updated geotechnical information is now sufficient for the project, the site investigation is terminated.

f. If the amended subsurface profile estimate is still not sufficient, then a geotechnical physical site exploration plan is formulated. The number and location of the test sites will be dictated by site variability.

#### 2.13.5 Geophysical surveys and ground truthing.

2.13.5.1 Geophysical methods are generally characterized by large-scale measurements that produce an averaging of the sediment properties over the zone of test influence, but without the capability of obtaining or testing a specific sample. EM 1110-1-1802 describes geophysical methodologies, and EM 1110-2-1003 describes specific geophysical methods that can be considered for continuous documentation of bottom and subbottom materials.

2.13.5.2 The distinguishing character of all geophysical methods is the ability to provide a continuous sediment profile, with only a few general sediment characteristics indicated, and the requirement for extensive calibration, usually with ground truth (direct sediment sampling and testing) studies of the in situ project sediments. Ground truth tests indicate the characteristics of the sediments only in the immediate location of the boring or pit. Extrapolation of these data between borings or pits requires considerable interpretation of all other available data. Stratification that may be inferred from one boring or a group of borings may not be valid because of discontinuities or inclusions that have been missed. As stated by Jones (1984): “The two techniques, drilling and profiling, are therefore, in many ways, complementary. The strength of one being the weakness of the other and vice versa.” Most of the available geophysical systems can be operated from a vessel underway. Several types of geophysical methods used for characterizing sediments are described below.

### 2.13.5.3 Nuclear density probes.

a. Nuclear density probes can be used to measure the density of bottom sediments. Most nuclear density probes work on the principle that a more dense material will absorb a higher percentage of the radiation passing from the source to the detector than will a less dense material. A typical probe is configured so that the sediment material passes between the source and detector as the probe is lowered. Nuclear density probes can give an accurate graph of sediment density as a function of depth if properly calibrated and used.

b. Nuclear density probes are used as a depth-measuring technique in The Netherlands, where fluid mud is a widespread condition and neither acoustic reflection nor lead line depth-sounding techniques give acceptable results. A limitation to the use of nuclear density probes, however, is the severe regulations governing their use, including the extensive paperwork involved. Nuclear density probes can be used only by licensed personnel, and the license is difficult to obtain. In addition, nuclear density probes must be stored under special conditions that are expensive to implement and maintain (EM 1110-2-1003).

2.13.5.4 Non-nuclear density probes. Non-nuclear density probes operate on various principles, including acoustic and mechanical. One type of acoustic probe, the High Resolution Density Profiler (HRDP), uses ultrasound. An example of a mechanical density probe is the DensiTune® Silt Density Probe.

2.13.5.4.1 High Resolution Density Profiler (HRDP). An Interagency Agreement (IAG) was signed between the USACE Engineer Research and Development Center (ERDC) and USEPA's Environmental Sciences Division (ESD) of the Office of Research and Development's National Exposure Research Laboratory, the objective of which is to have the ERDC modify the Advanced Modular Ultrasound System (ADMUS) probe (an acoustic impedance-based navigation fluid mud survey prototype system successfully demonstrated in the Gulfport, MS, navigation channel and in the laboratory) for use in characterizing dredge residuals for environmental dredge projects. Dredging residuals refer to contaminated sediment found at the post-dredging surface of the sediment profile, either within or adjacent to the dredging footprint. After the initial consolidation period (that is, within a period of several days to a few weeks, depending on sediment characteristics and site conditions), generated residuals (excluding sloughed materials) typically occur as a thin veneer (0.4-3.9 in/1-10 cm thick) of fine-grained suspended material.

a. One of the goals in developing this new sensor system (this is a current [2013] R&D project under the Dredging Operations and Environmental Research [DOER] Program) is to produce an instrument that uses easy-to-obtain, and well supported, acoustic-signal processing hardware and non-proprietary signal-processing techniques. The new sensor system is named the High Resolution Density Profiler (HRDP). The system's operational methodology to calculate density is based on the measurement of three ultrasound parameters:

- (1) Acoustic impedance of the medium ( $Z_{med}$ )
- (2) Sound speed within the medium ( $c_{med}$ )

31 Jul 15

## (3) Ultrasound transmission characteristics (attenuation) of the medium

b. The prototype probe (Figure 2-5) was tested in “static” buckets of various (bulk) density suspensions of fluid mud collected from the Gulfport (MS) Ship Channel and compared to laboratory pycnometer-measured densities. The results from these comparisons are shown in Table 2-1. Based on these promising results, the HRDP is currently (2013) being modified for subsequent laboratory and field testing.

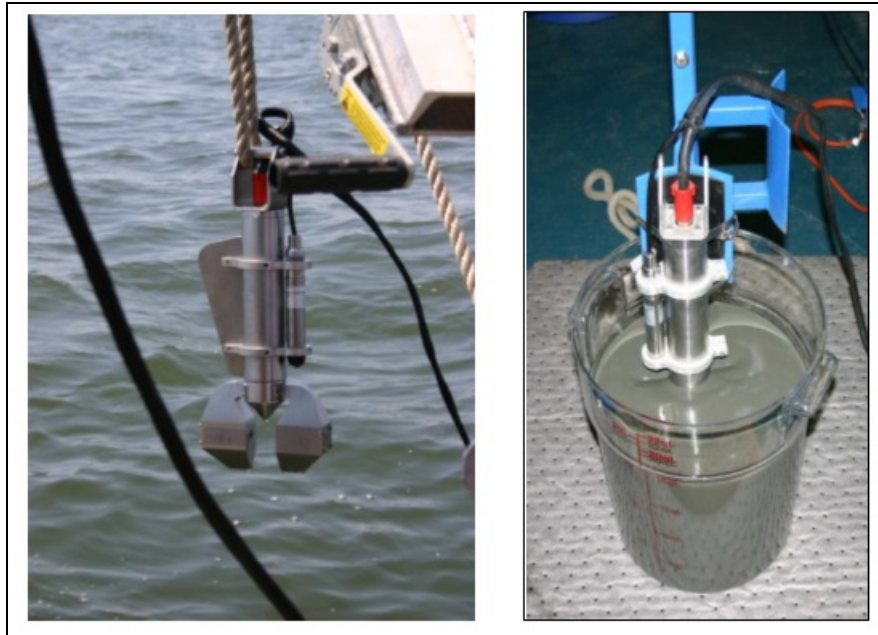

Figure 2-5. High-Resolution Density Profiler (HRDP) and its Immersion in a Static (Fluid Mud) Bucket Test

Table 2-1. HRDP-Measured Densities Compared with Pycnometer-Measured Densities

Pycnometer Density	Average HRDP Density	HRDP Standard Deviation	Difference HRDP-Pycnometer
0.997*	0.995	0.002	-0.002
1.082	1.092	0.029	0.010
1.127	1.125	0.005	-0.002
1.141	1.133	0.007	-0.008
1.170	1.166	0.006	-0.004
1.193	1.228	0.005	-0.035

Note: Values are in g/cm<sup>3</sup>

More detailed information on surveying in channels with unconsolidated bottom material (for example, fluid mud) is available in EM 1110-2-1003.

2.13.5.4.2 The STEMA System. The STEMA system consists of two primary components, a DensiTune (or RheoTune, Figure 2-6) probe and the SILAS software. The system is designed to estimate both the nautical depth in navigation channels and the density of silt layers in dredge



and placement areas, and to monitor siltation in ports and marine traffic areas. The DensiTune and RheoTune are fluid mud-profiling probes that operate on the “tuning fork” principle, with one of the legs of the tuning fork vibrating at a specific frequency and the other leg vibrating at a frequency that depends on the density and rheological properties of the medium into which the probe is inserted. The DensiTune probe measures in situ density vs. depth, and the RheoTune system measures in situ density, shear strength, and viscosity vs. depth. The SILAS software was developed for the acquisition and processing of acoustic subbottom reflection signals in the low-frequency range of 3.5 to 33 kHz. The low-frequency acoustic returns are processed to determine signal attenuation and are calibrated for density with the density profiles collected with the DensiTune or RheoTune.

a. Under the USACE Dredging Operations and Environmental Research (DOER) program, the DensiTune and RheoTune density probes and SILAS software have been tested and evaluated on some USACE coastal navigation projects by the ERDC Coastal Hydraulics Laboratory (CHL) in conjunction with surveying conducted by the USACE New Orleans District (CEMVN) and Mobile District (CESAM). The tests indicate that these systems have potential for reliably measuring nautical bottom, as previously described.

b. The New Orleans District deploys RheoTunes down into the channel from the S/V Teche by a semi-automated winch (Figure 2-7) to measure and record water densities, fluid mud densities, and yield stresses as a function of depth. Figure 2-8 presents an example of a DensiTune’s density vs. depth profile from the Calcasieu Bar Channel (New Orleans District). Measurements were taken in 42 ft (12.8 m) at the right quarterline on 5 October 2011, one week after a Wheeler Dredging Exercise. A density of 1100 g/l (green) was recorded at -37.0 ft (-11.3 m) depth and 1200 g/l (blue) at -39.0 ft (-11.9 m). Figure 2-9 shows a SILAS-generated cross-section from the Gulfport Ship Channel (Mobile District), illustrating the concept of select density horizons generated from total acoustic reflection signals. Figure 2-10 illustrates three different density horizons ( $1.20 \text{ g/cm}^3$ ,  $1.16 \text{ g/cm}^3$ , and  $1.03 \text{ g/cm}^3$ ) relative to the channel template.



Figure 2-6. STEMA RheoTune Tuning Fork Shear Strength, Viscosity, and Density Probe

31 Jul 15



Figure 2-7. STEMA RheoTune Probe Being Deployed off the New Orleans District's S/V Teche via a Semi-Automated Winch

#### 2.13.6 Underwater sediment sampling.

2.13.6.1 Samples of the channel sediments to be dredged are often required for adequate characterization of the material and for use in laboratory testing. Sediment sampling and testing are used to determine dredgeability and provide the data necessary for designing placement and beneficial uses alternatives. The level of effort required for channel sediment sampling is highly project dependent. If the geophysical survey is required, samples may be required for ground truth interpretations. In the case of routine maintenance work, data from prior samplings and experience with similar material may be available, and the scope of field investigations may be reduced. For unusual maintenance projects or new-work projects, more extensive field investigations are required.

2.13.6.2 For maintenance work, channel investigations may be based on grab samples of sediment. Since bottom sediments are in an essentially unconsolidated state, grab samples are satisfactory for sediment characterization purposes and are easy and inexpensive to obtain. Grab sampling may indicate relatively homogeneous sediment composition, segregated pockets of coarse- and fine-grained sediment, and/or mixtures. If segregated pockets are present, samples may be taken at a sufficient number of locations in the channel to define spatial variations in the sediment character adequately. In any case, results of grab sampling must allow estimation of the relative proportions of coarse- and fine-grained sediments present. Caution should be exercised in interpreting conditions indicated by grab samples since sediment surface samples do not indicate variation in sediment character with depth.

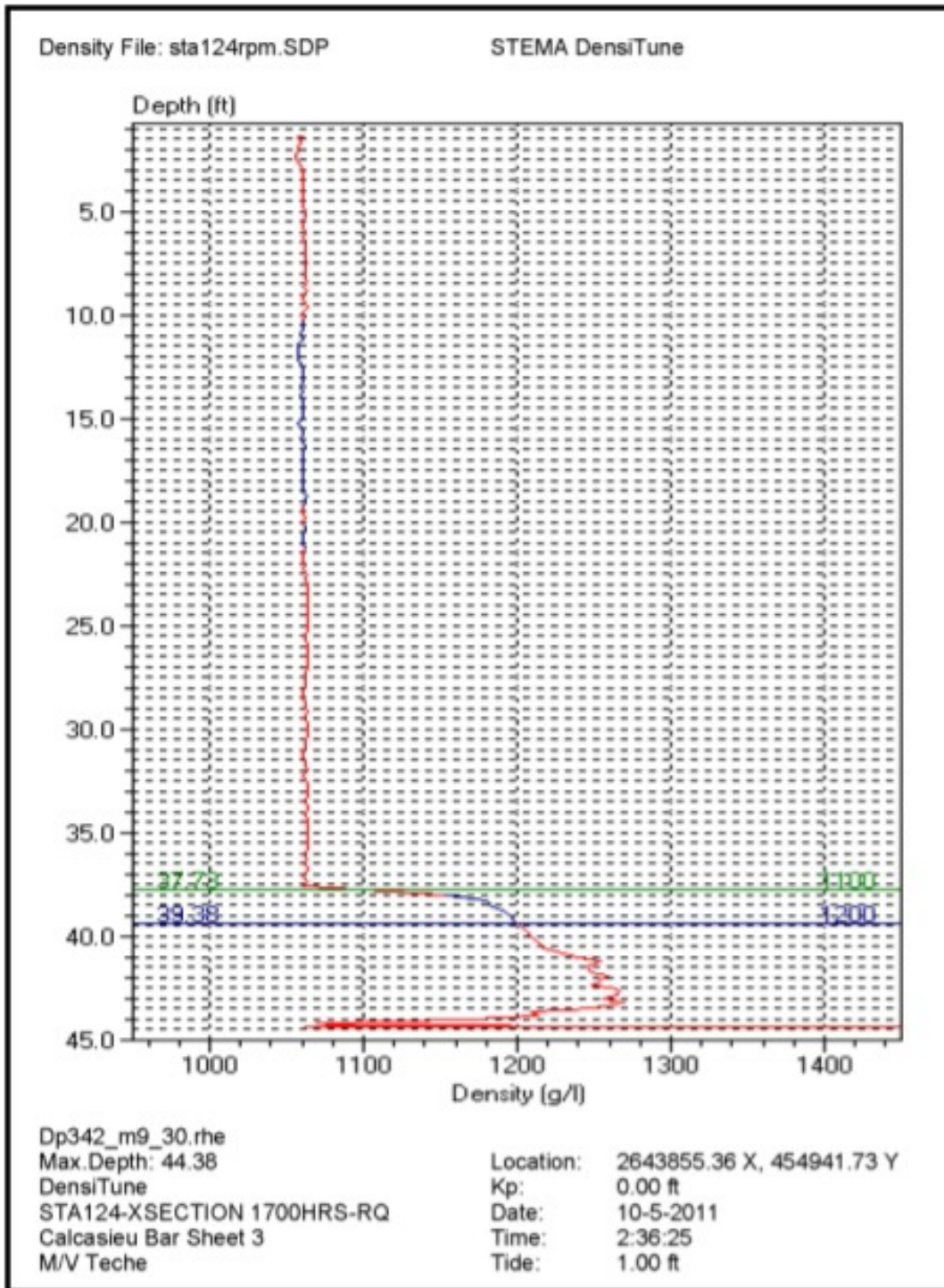

Figure 2-8. STEMA DensiTune Measurements Taken in 42 ft (12.8 m) at the Right Quarterline of the Calcasieu Bar Channel on 5 October 2011, One Week after a Wheeler Dredging Exercise (New Orleans District)

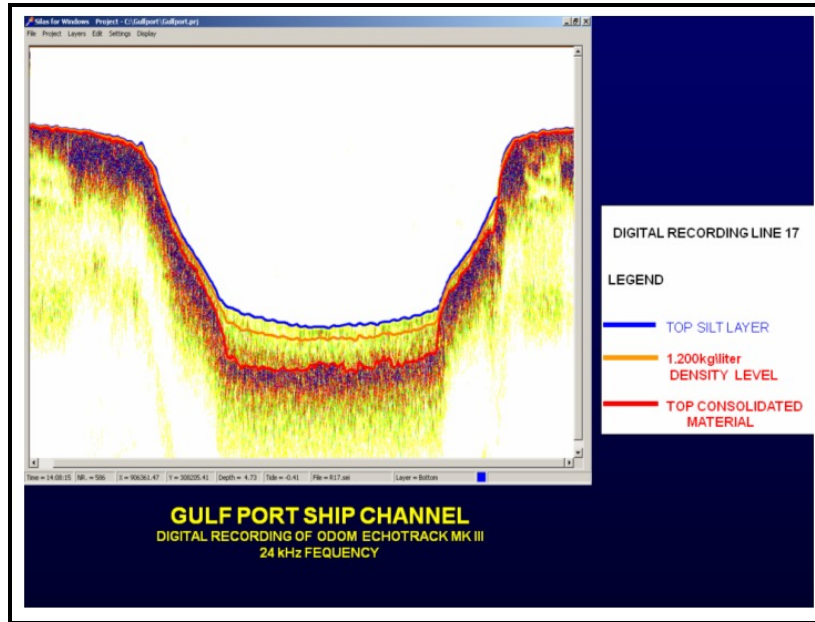

Figure 2-9. SILAS-Generated Cross Section of the Gulfport Ship Channel, Illustrating the Concept of Measuring the Top of Fluid Mud, 1.2 g/cm<sup>3</sup> Density Horizon, and the Top of Consolidated Material (Mobile District)

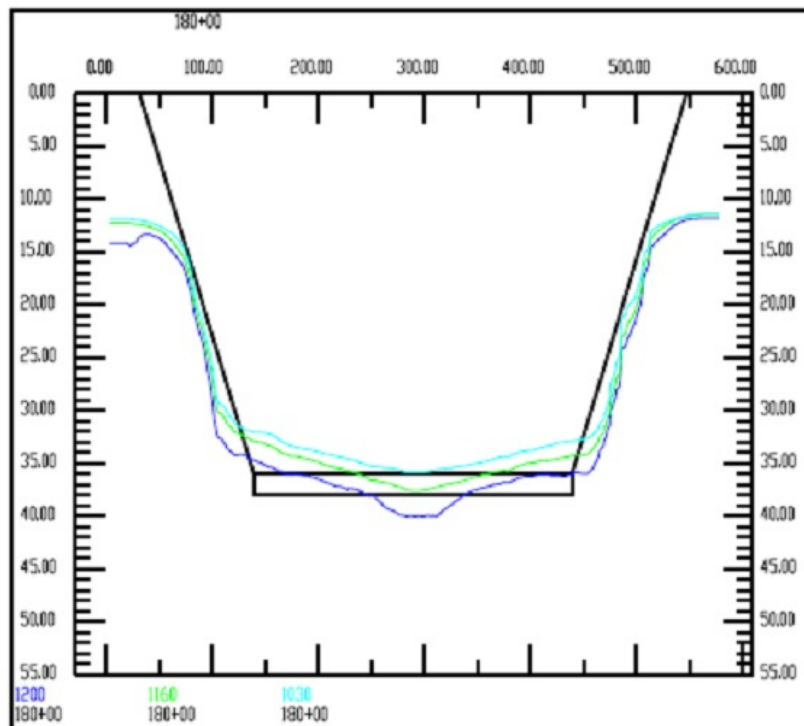

Figure 2-10. SILAS-Analyzed Density Horizons (1.20 g/cm<sup>3</sup>, 1.16 g/cm<sup>3</sup>, and 1.03 g/cm<sup>3</sup>) of STA 180+00 Gulfport Ship Channel, 9 April 2012, Relative to the Channel Template (Mobile District)

2.13.6.3 For more detailed information, additional samples may be taken using conventional boring techniques. Samples of sediment taken by conventional boring techniques are normally required only in the case of new-work dredging. Locations for borings should be selected based on information gained from the geophysical survey and/or initial grab sampling. Samples should be taken from within the major zones of spatial variation in sediment type or along the proposed channel center line at constant spacing to define stratification within the material to be dredged and to obtain representative samples. Proper selection of boring depths should include characterization depths that consider the dredge's excavating accuracy and respective project-specific conditions because it is critical to ensure future compatibility of the dredging description and quantities in environmental compliance documentation with the dredging as actually implemented. Tavolaro et al. (2007) describe in a technical note the excavation accuracy of various dredges under different project conditions and provide guidance to USACE personnel in determining depths to adequately characterize and evaluate material to be dredged in the entire dredging prism, including paid allowable overdepth and non-pay dredging. This technical note also improves communication on these subjects with other agencies and the public. Boring is normally done on a routine basis for new-work projects to indicate the type of material to be dredged and its dredgeability since this information is required for the dredging contractor to use as a basis for bidding on the project. Test pits using a clamshell dredge can also prove useful for assessing dredgeability and can be used to obtain larger sample quantities.

2.13.6.4 Three terms regarding sediment sampling deserve strict definition: "in situ," "undisturbed sample," and "representative sample." "In situ" is derived from "at the site" and is generally used to indicate the condition of a sediment as it exists at its naturally placed location before intervention by man or machine. A truly "undisturbed sample" is one that maintains all of the in situ sediment mass characteristics including shape, volume, pore structure and size, grain orientation and structure, and the in situ horizontal and vertical pressures. In reality, a so-called "undisturbed sample" cannot completely retain all of these attributes; however, except for the in situ pressures, an attempt is made to maintain as much as possible of the other characteristics. A "representative sample," on the other hand, may be remolded slightly or completely; that is, it contains all of the sediment material (both solids and fluids) of its in situ state but does not maintain the original structure, grain orientation, or in situ density. Such samples are appropriate for sediment material properties tests, but not for all sediment mass properties tests. The sediment material properties are those of the sediment components without reference to their arrangement in a sediment mass, (the individual grains, the pore water, or the other materials present). Sediment material identification tests are performed on a sample of sediment whose in situ mass structure has been completely disturbed by remolding. The sediment mass properties are those relating to the arrangement of the material components. They include the relative positions of the sediment grains, their structure, and their strength properties. The sediment material and sediment mass properties are independent of each other. The same sediment material can exist in a number of different arrangement states, and different sediment material can have the same water content, density, and other sediment mass characteristics (Spigolon 1993). Guidance to select sampling apparatus to obtain undisturbed samples is provided in EM 1110-1-1906.

2.13.6.5 Sampling and/or field testing of sediment involves penetration or excavation of the sediment to the sample or test depth. Such excavations are typically made by probing, pits,



trenches, or borings. A number of methods are available for each of the processes involved in securing samples. Each method has its own specific purpose, advantages, limitations, cost, and value. Mudroch and Azcue (1995) present background information on techniques for sampling aquatic sediments. USEPA (2001) provides a compilation of current information and recommendations for collecting, handling, and manipulating sediment samples for physicochemical characterization and biological testing. EM 1110-1-1906 presents the principles, equipment, procedures, and limitations for obtaining, handling, and preserving sediment samples in support of civil and military projects. This EM also provides guidance for obtaining sediment samples in the nearshore environment, such as harbors, rivers, coastal plains, back swamps, and wetlands, where the depth of water varies from 0 to 45 m and is generally less than 20 m. Generally, sampling sediment underwater in the nearshore environment is not significantly different from sampling soils on land. The concerns for obtaining minimally disturbed samples for geotechnical testing are the same; the samples are just more difficult to obtain. In addition to the need to find the right equipment for obtaining samples, a work platform or vessel and a positioning system are needed. The wind, waves, tides, currents, and water depths must also be considered when planning a site investigation.

2.13.6.6 The selection of appropriate sampling equipment for retrieving underwater samples depends upon several factors: sediment data required; sizes of test specimens needed; sediment type; geology; the depth of water or elevation of the sea, river, or lake bottom; environmental conditions; vessel availability; and funding limits. These factors do not always favor selections that are compatible. For example, the equipment required to obtain the size and/or quality of sample(s) may not be deployable from the vessel available within the project budget, or the available vessel may not be able to operate in the required shallow-water depths. Each of these factors is discussed in EM 1110-1-1906.

2.13.6.7 Test pits and trenches are usually made with mechanical cutting and removal equipment, such as clamshell (grab), dragline, or backhoe machines. The process of excavating a pit or trench may, in itself, be a form of test dredging. The pit is dug to the sampling or testing depth. Sampling or testing is then done at the surface of the pit using a surface-operated system, by a bottom-supported, remotely operated device or by a diver. The excavated material is usually a representative sample if care is taken in the excavation/sampling process.

2.13.6.8 Some sediments, such as coarse gravel, cobbles, boulders, shells, and debris, cannot be sampled effectively using the usual boring and sampling methods of geotechnical engineering. A test pit or trench is then the only way of obtaining a representative sample of the sediment. In these instances, in situ strength is usually not a factor, and a disturbed, but representative, sample is very useful for describing the character of the sediment.

2.13.7 Underwater sediment samplers. The most common types of underwater samplers can be divided into three categories based upon the method of deployment: free samplers, tethered samplers, and drill string samplers.

a. Free samplers. Free samplers include hand-held, diver-operated samplers and remotely operated vehicles samplers that can be deployed with minimal attachments to the work platform.

b. Tethered samplers. Tethered samplers are attached to the work platform by some type of umbilical support cable or a lowering wireline. Tethered samplers can be subdivided into dredges and grab samplers, box cores, gravity cores, and bottom-resting samplers.

c. Drill string samplers. Drill string samplers, as the name implies, operate through a drill string and drill rig. Diamond core barrels are used to retrieve samples of extremely hard sediment—shale and cemented soil that are too hard for sampling by the direct insertion of a tube. Drill string samplers also include the split-barrel sampler used in the Standard Penetration Tests (SPT).

The following subparagraphs present an overview of several grab samplers, gravity cores, bottom-resting samplers, and drill string samplers used in dredging-related geotechnical investigations. For more detailed information concerning these underwater samplers (including the free samplers mentioned above), refer to EM 1110-1-1906.

2.13.7.1 Grab samplers. A grab sampler consists of a scoop or bucket container that bites into the soft sediment deposit and encloses the sample (Figure 2-11). Grab samplers are used primarily to sample disturbed surface materials, with depth of penetration being 0.3 m or less. Grab samplers are easy and inexpensive to obtain and may be sufficient to characterize sediment for routine maintenance dredging. Although the samples are invariably disturbed so that little semblance of the original structure remains, some grab samplers can retrieve samples suitable for water content and density laboratory analyses. All are designed to bite, or be pushed, into the sediment and enclose a representative sample; therefore, the design must ensure that once the sample is in the device, there can be no loss or dilution of sediment during the recovery from the bottom. This type of sampling device can be positioned accurately on the bottom. Sampling is limited to those surface sediments that can easily be cut by the grab or scoop or that are easily penetrated by a push tube. Grab sampling may indicate relatively homogeneous sediment composition, segregated pockets of coarse- and fine-grained sediment, and/or mixtures. If segregated pockets are present, samples should be taken at a sufficient number of locations in the channel to adequately define the spatial variations in the sediment character and quantities of each material.

a. Petersen samplers. The Peterson sampler (Figure 2-11) has a system of levers to keep the scoop open while the sampler is lowered to the bottom. As the sampler comes to rest on the bottom, the tension in the retrieval line is relaxed, the trip lever drops, and the sampler is ready to obtain the sample. After the trip lever has been released, tension is again applied to the retrieval line. During this time, the jaws slowly shut, enclosing the sample within the scoop. The Petersen sampler is a versatile sampler that can sample a wide range of sediments, from fluffy harbor sediments to dense sand deposits in rivers. It weighs 85 kg (39 lb) empty, with additional weights available to provide a total weight of 205 kg (93 lb), and it samples approximately 1,000 cm<sup>2</sup> to a depth of about approximately 0.3 m, depending on the consistency (the relative ease with which a soil can be deformed [ASTM D 653]) of the bottom.

b. Birge-Ekman samplers. The Birge-Ekman sampler (Figure 2-11) is a widely used piece of equipment. To obtain a sample, it is lowered to the bottom, with its scoop held open by springs. When it is resting on the bottom, the operator releases a weight attached to the retrieval line. The weight slides down the line, striking the tripping mechanism, and the scoop shuts, enclosing the sample. The sampler is then raised to the surface, and the sample is transferred to a container.

While weights may be added to increase its penetration, the Birge-Ekman sampler is well suited for only very soft sediments. For example, it is excellent for obtaining samples of slurries in hopper dredge bins. Petite and standard sizes are available, weighing approximately 8 kg (18 lb) and 13 kg (29 lb), with sample chambers ranging from 3,500 to 28,320 cm<sup>3</sup> (Mudroch and Azcue 1995).

c. Ponar samplers. The Ponar sampler (Figure 2-11) is similar in construction to the Petersen sampler. A system of levers keeps the scoop open during descent. Once the sampler is on the bottom, the retrieval line tension is relieved, and the levers are disengaged. After the levers have disengaged and the scoop is free to close, tension is again applied to the retrieval line, closing the scoop. The sampler is then raised to the surface, where the sample is transferred to the sample container. The Ponar sampler is ineffective in hard clay. It comes in petite and standard sizes, with sampling volumes of 1,000 cm<sup>3</sup> and 7,250 cm<sup>3</sup> and weights of 10 kg (22 lb) and 23 kg (50 lb), respectively (Mudroch and Azcue 1995).

d. Shipek samplers. The Shipek dredge (Figure 2-11) uses two concentric half-cylinders to form the sample scoop. It is lowered to the bottom, where a weight releases the triggering mechanism. Then the scoop gathers a sample as it rotates through a half-circular arc under the force of springs. Finally, the sampler is hoisted to the water surface, where the scoop is released; the sample is then transferred to a container. This sampler weighs 50 kg (110 lb) empty and obtains a 3,000-cm<sup>3</sup> sample (Mudroch and Azcue 1995).

e. Drag buckets. The drag bucket (Figure 2-11) differs from other grab samplers since it does not bite vertically into the sediment. Rather, it skims an irregular slice off the top of the deposit. Therefore, the size and shape of the slice are difficult to ascertain. This irregularity disturbs sample material and mass properties. Drag buckets are available in assorted sizes with round or square biting lips and are suitable only for very soft deposits in quiescent waters.

2.13.7.2 Gravity corers. Although several types of gravity corers are available, all are operated similarly. In general, gravity corers consist of a large weight on top of a steel core barrel, which contains a plastic liner. The corer is raised and lowered to the sediment surface by a wireline although during the actual sampling process, the corer is allowed to free fall and penetrate the sediment. Gravity corers have been classified by size or by the operational method. Historically, they were divided into three groups based on size: Phleger corers, Ewing corers, and deep-ocean corers. Today, several sizes of gravity corers are available; consequently, the operational method, which is based upon the requirement that a valve or internal piston is used to enhance sample recovery, provides a better classification system. Typically, the shorter, smaller corers use a valve and are commonly referred to as gravity corers whereas the larger, longer corers use a piston and are referred to as piston corers. EM 1110-1-1906 provides a discussion of gravity and piston corers. A Phleger corer as an example of a gravity corer (Figure 2-12). The Phleger corer is widely used for obtaining samples from the upper portion of underwater deposits. It is available with adjustable weights in the range of 37 to 170 kg (17 to 77 lb) and in fixed weights in excess of 200 kg (90 lb). The amount of weight depends on the texture of the deposit and the required depth of penetration. Phleger corers, like most gravity corers, sample a small area, usually between 13 and 23 cm<sup>2</sup> (2 and 4 in<sup>2</sup>). Disturbance of the sediment is a function of the area ratio (thick versus thin wall), the type of sediment, its strength, side friction in the sample tube, and the ease with which water in the tube can be ejected in front of the entering sample.



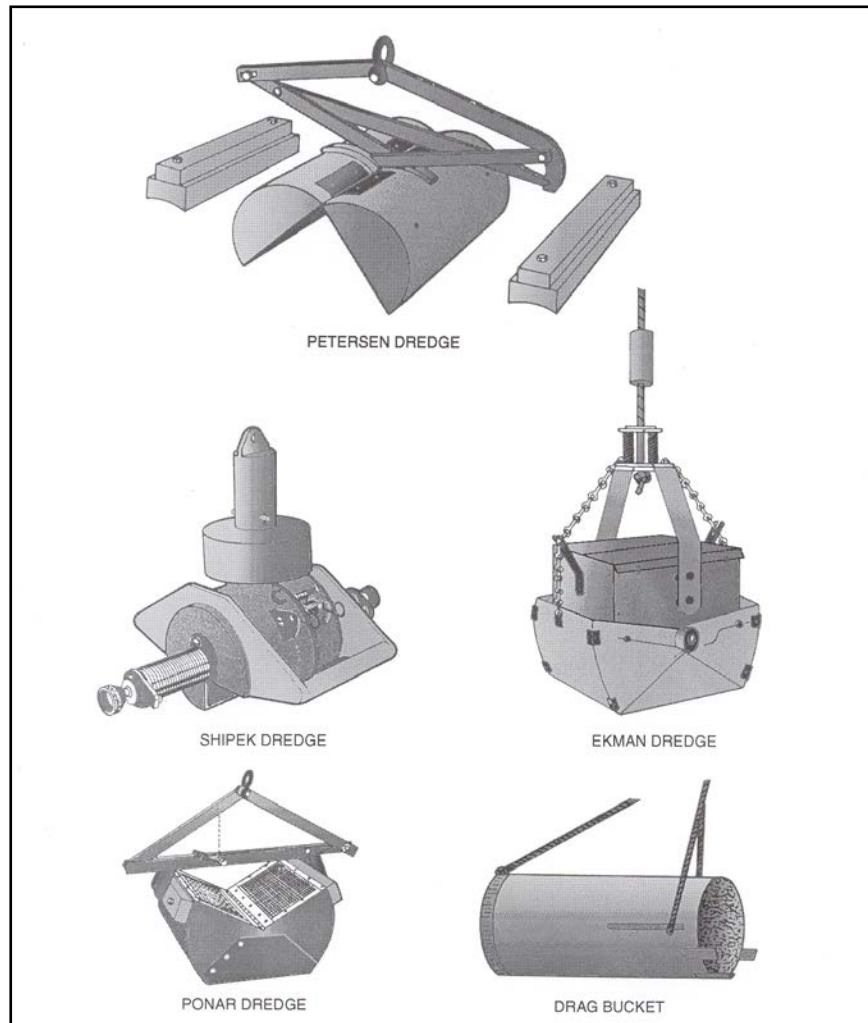

Figure 2-11. Grab Sediment Samplers

2.13.7.3 Vibracorer (or vibratory corer) samplers. High-frequency vibration of the sampler during pushing is another means of inserting a sample tube into a sediment deposit. There are several manufacturers of vibracorer samplers worldwide. These devices impart a sample disturbance to the sediment, the magnitude of which depends on the effect of the vibration, the side friction in the tube, and the vertical stability of the tube during penetration. The vibracorer consists of a vibratory head attached to the top of the core barrel (Figure 2-13). The corer is supported in a bottom-resting frame that helps to ensure that the core barrel enters the sediment vertically as well as doubling as a reaction for advancing the sampling tube. The combination of weight and vibration is generally used to drive the core barrel into the sediment although vibrations can be combined with impact driving for some types of devices to increase the penetration. The vibrator can be electric, pneumatic, or hydraulic. The vibracorer can be equipped with a penetration recording device that will provide a record of the penetration depth and time. After the core barrel has been extended to its full length, the sampler is retracted from the sediment and returned to the floating plant deck. The movable plastic core barrel containing the sample is then removed from the sampling device, and the ends are capped for sample preservation. Core sizes range from 76 to

152 mm in diameter and from 3 to 12 m in length. While this device is generally used to sample sands, it has also been used to sample some fine-grained materials.

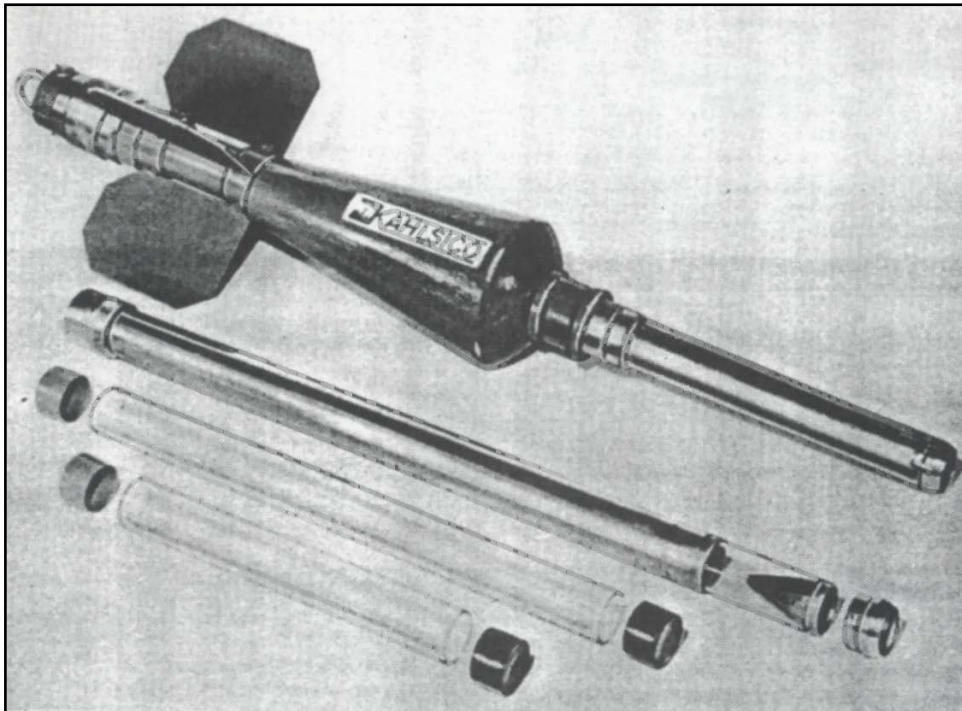

Figure 2-12. Phleger Gravity Corer (U.S. Naval Facilities Engineering Service Center)



Figure 2-13. Alpine Vibracorer

2.13.7.4 Box corers. A box corer is a device that contains a box that takes a large, relatively undisturbed sample when lowered by a wireline from the work platform to the sea floor (Figure 2-14). The box corer is pushed into the sediment by its own weight. When the deployment line is retracted, a rotating spade closes off the bottom of the box before the box corer is lifted. Most box corers can be operated in any water depth. Box corers are available from several manufacturers, and therefore the design, size, and operation of each may vary slightly. The boxes are usually constructed of stainless steel or aluminum, sizes range from 10 by 30 by 30 cm to 30 by 30 by 90 cm to as large as 50 by 50 by 60 cm. Most boxes have a bottom plate for supporting the sample in transport and a removable side for access to the sample after it has been retrieved. The principal advantage of a box corer is that a large, relatively undisturbed sample of cohesive material can be retrieved. The disadvantages of the box corer include the short length of sample retrieved and the difficulty of sampling cohesionless sediments, which usually wash out of the box corer during retrieval. A cohesive soil is “a soil that, when unconfined, has considerable strength when air-dried and that has significant cohesion when submerged (strength being defined as the maximum stress which a material can resist without failing for any given type of loading).” In contrast, a cohesionless soil is “a soil that when unconfined has little or no strength when air dried and that has little or no cohesion when submerged” (ASTM D 653).

2.13.7.5 Drill string samplers. A number of drill rigs and sampling equipment are available for performing conventional drilling and sampling operations and for conducting in situ tests. These various types of rigs and sampling equipment and the respective operating procedures for disturbed and undisturbed sampling are all described in detail in EM 1110-1-1906. Two drill string samplers commonly used in dredging are the split barrel sample spoon and corers.

a. Split-barrel sample spoon. The split-barrel sample spoon (also known as split-spoon sampler) (Figure 2-15) is capable of penetrating hard sediments, provided sufficient force is applied to the driving rods. The sampler is thrust into the deposit by the hammering force exerted on rods connected to the head. During retrieval, the sample is retained within the barrel by a flap. The nose and head are then separated from the barrel to transfer the sample to a container.

b. Corers. Extremely hard soils (shale and cemented soils) and rock are too hard for sampling by the direct insertion of a metal tube. Therefore, an undisturbed core is obtained by fitting the circular end of a rotating sampling tube with a hardened steel cutting surface or bit. Rotary drill rigs are the workhorses of most geotechnical engineering drilling and sampling operations (EM 1110-1-1906). For cutting rock, industrial diamonds are embedded in the cutting edge of the bit (Figure 2-16). Soft rock, cemented soils, and hard clays can be drilled with a hardened steel serrated bit instead of diamonds in the tip of the core barrel. Samples of sediment taken by conventional boring techniques are normally required only in the case of new-work dredging. Based on information gained from the geophysical survey and/or initial grab sampling, locations for borings should be selected. Samples should be taken from within the major zones of spatial variation in sediment type or along the proposed channel center line at constant spacing to define stratification within the material to be dredged and to obtain representative samples. Borings should be advanced to the full depth of anticipated dredging and then 1.5-3 m beyond if possible. This is normally done on a routine basis for new-work projects to indicate the type of material to be dredged and its dredgeability since this information is required

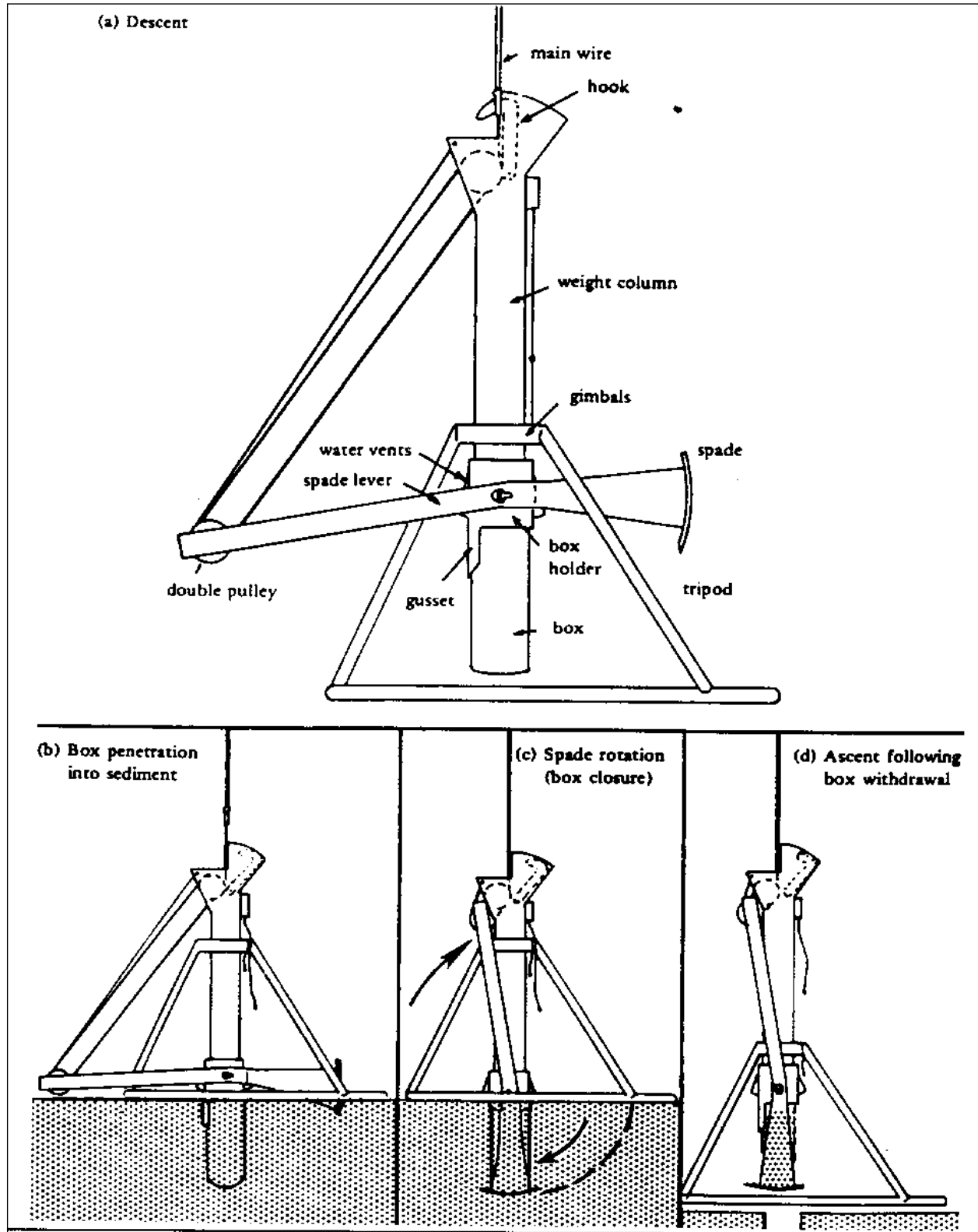

Figure 2-14. Box Corer (from U.S. Naval Facilities Engineering Service Center)

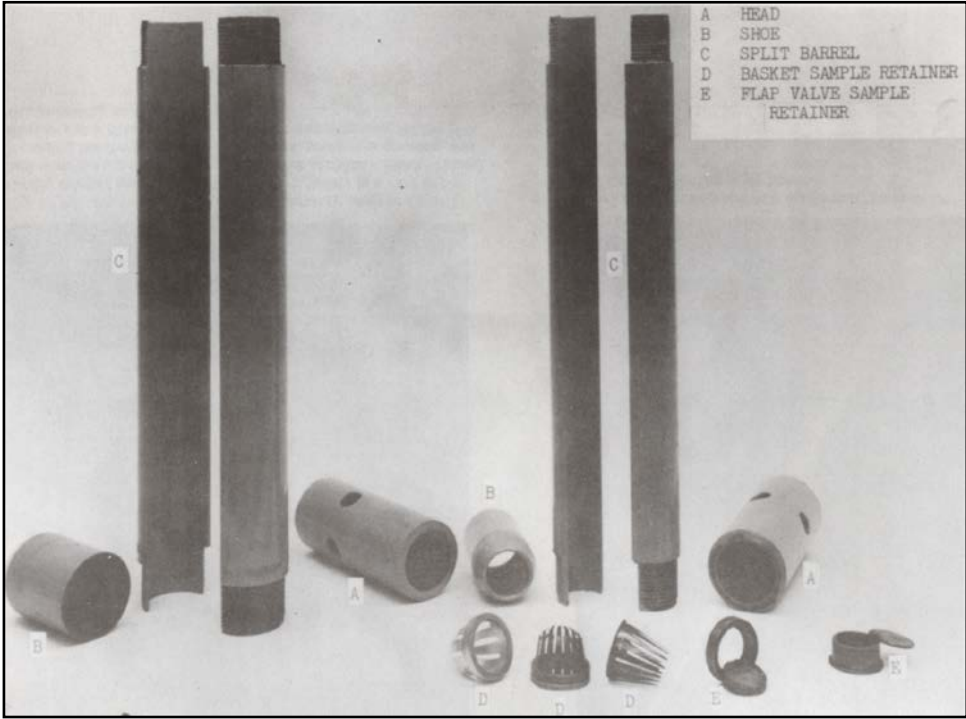

Figure 2-15. Split-Spoon Sampler (from EM 1110-1-1906)

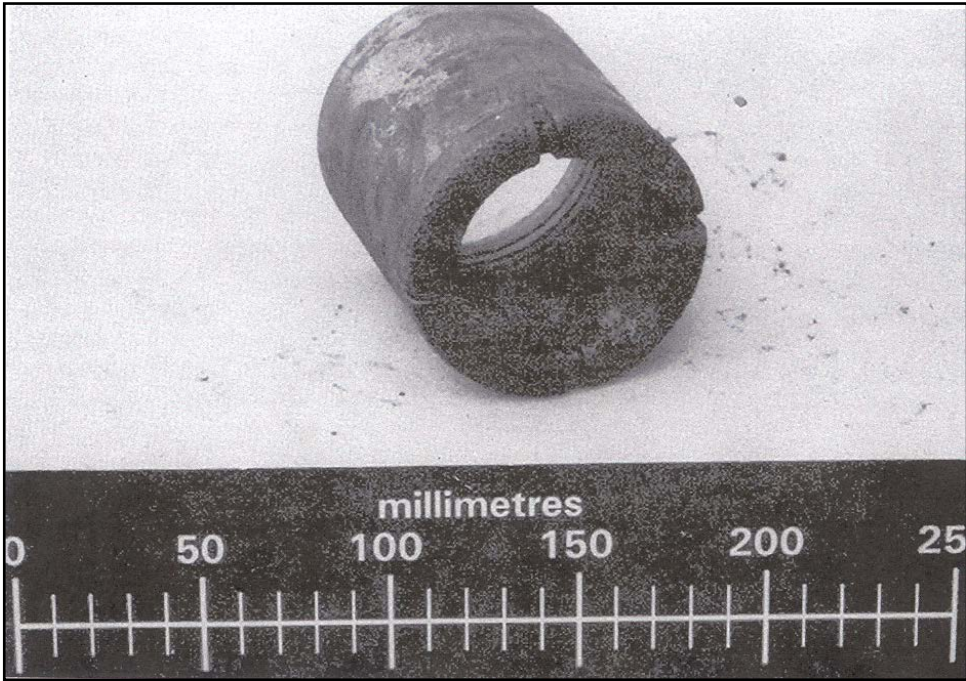

Figure 2-16. Typical Diamond Coring Bit (from EM 1110-1-1906)



for the dredging contractor to use as a basis for bidding on the project. Coring is relatively expensive, and particular attention should be given to the vertical control to position the elevations used to reference the cores accurately. However, jet probing is an inexpensive method to collect additional information on the top elevation of the rock structure between borings. A jet probe consists of inserting a pipe with water running through the center into unconsolidated material and applying a downward force until refusal (that is, no observed advance of jet probe).

#### 2.14 Placement Site Geotechnical Investigations.

2.14.1 Field investigations must also be performed at proposed placement sites to define foundation conditions and to obtain samples for laboratory testing. This is especially important for proposed Confined Disposal Facilities (CDFs). The extent of required field investigations depends on the project size and the foundation conditions at the site. It is particularly important to define foundation conditions (including depth, thickness, extent, and composition of foundation strata), groundwater conditions, and other factors that may influence construction and operation of the site. For new CDFs, the field investigations required for estimating long-term storage capacity should be planned and accomplished along with those required for the engineering design of the retaining dikes, as described in Chapter 4, “Confined (Diked) Placement.”

2.14.2 For existing containment areas, the foundation conditions may have been defined by previous subsurface investigations made in connection with dike construction. However, previous investigations may not have included sampling of compressible soils for consolidation tests; in most cases, suitable samples of any previously placed dredged material are not available. Field investigations must therefore be tailored to provide those items of information not already available.

2.14.3 Undisturbed samples of compressible foundation soils can be obtained using conventional soil sampling techniques and equipment described in EM 1110-1-1906. If dredged material has previously been placed within the containment area, undisturbed samples must be obtained from borings taken within the containment area, but not through existing dikes. The major problem in sampling existing containment areas is that the surface crust does not normally support conventional drilling equipment, and personnel sampling in these areas must use caution. Below the surface crust, fine-grained dredged material is usually soft, and equipment sinks rapidly if it breaks through the firmer surface. Lightweight drilling equipment supported by mats are normally required if crust thickness is not well developed. In some cases, sampling may be accomplished manually if sufficient dried surface crust has formed to support crew and equipment. More detailed information regarding equipment use in containment areas may be found in Chapter 4, “Confined (Diked) Placement.”

2.14.4 Water table conditions within the containment area may be determined to estimate loadings caused by the placement of dredged material. This information may be obtained by piezometers, which may also be used for measurement of groundwater conditions during the service life of the area. Other desired instrumentation, such as settlement plates, may also be installed within the containment area for monitoring various parameters.

2.14.5 Additional information regarding conventional sampling techniques and equipment and development of field exploration programs is given in EM 1110-1-1906. Procedures for installation of piezometers and other related instrumentation are given in EM 1110-2-1908.

## 2.15 Sediment Physical and Engineering Properties Testing.

### 2.15.1 General.

2.15.1.1 Tests on sediment samples to determine physical and engineering properties may be required to provide data for determining the proper dredge plant, evaluating and designing placement alternatives, designing channel slopes and retention dikes, and estimating long-term storage capacity for confined and unconfined placement areas. Evaluation of the physical characteristics of material proposed for discharge is necessary to determine potential environmental impacts of placement, the need for additional chemical or biological testing, and feasibility of potential beneficial uses of the dredged material. The tests presented below may be used to characterize the material to be dredged so that proper dredge plant and placement and/or beneficial uses methods can be selected.

2.15.1.2 Tests to determine geotechnical properties of soil and rock have been standardized by organizations such as the ASTM and American Association of State Highway and Transportation Officials (AASHTO), but no standards address test methods specific to dredged material soil and rock characterization. The variability in properties and performance behavior of dredged material soil and rock often leaves the selection of characterization test methods open to interpretation. The desired end purpose guides the interpretation process. For example, soil classification requirements for determining dredgeability may differ from those needed for input into containment area design or sediment fate models. Sediment characteristics and requirements for settling data and for long-term storage capacity dictate which laboratory tests are required for containment area design. Tests conducted to determine dredgeability depend on the sufficiency of existing data and which of the four stages of the dredging process(s) (excavation, removal, transportation, or placement) the geotechnical information is required for.

2.15.1.3 Physical tests and evaluations on sediment can include visual classification, in situ water content/solids concentration/bulk density, plasticity indices (Atterburg limits), organic content, grain-size distributions, specific gravity, consolidation, and Unified Soil Classification System (USCS) classification. These laboratory tests are essentially standard tests and generally follow procedures found in EM 1110-2-1906 or those specified by ASTM. Table 2-2 gives the standard ASTM and USACE designations for several of these tests and also cross-references these procedures to those of several other organizations that have standardized test methods. Lee (2001a) describes several in situ expedient test methods to determine geotechnical properties of dredged materials, and Lee (2001b) provides an overview of geotechnical engineering properties of dredged materials and input requirements for selected fate of dredged material models. More specific tests used for the evaluation and design of confined placement alternatives are discussed in Chapter 4, "Confined (Diked) Placement," and those for beneficial uses are described in Chapter 5, "Beneficial Uses of Dredged Material."

Table 2-2. Standard Geotechnical Test Procedures

Test	Designation				Comments
	ASTM	AASHTO <sup>1</sup>	USACE <sup>2</sup>	DOD <sup>3,4</sup>	
Water content	D 2216	T265	I	Method 105, 2-VII	
Grain size	D 422	T88	V	2-III, 2-V, 2-VI	
Atterburg limits	D 4318	T89 T90	III	Method 103, 2-VIII	
Classification	D 2487		III		
Specific gravity	D 854	T100	IV	2-IV	
Organic content	D 2974				Use Method C
Consolidation <sup>5</sup>	D 2435	T216	VIII		
Permeability <sup>6</sup>	D 2434	T215	VII		
Shear tests	D 2573				Field test

<sup>1</sup> The Materials Book, AASHTO.  
<sup>2</sup> EM 1110-2-1906.  
<sup>3</sup> Department of Defense (1964) (Method 100, etc.).  
<sup>4</sup> Department of Army (1987) (2-III, etc.).  
<sup>5</sup> Do not use the standard laboratory test for determining consolidation of highly compressible, high-water-content sediment samples. Instead, use the modified standard consolidation test and self-weight consolidation test as described in Chapter 4, "Confined (Diked) Placement."  
<sup>6</sup> One value of permeability must be calculated from the self-weight consolidation test.

2.15.1.4 As previously discussed, the extent of the testing program is project-dependent. Fewer tests are required when dealing with a relatively homogeneous material and/or when data are available from previous tests and experience as is frequently the case in maintenance dredging. For new-work projects and unusual maintenance dredging projects where considerable variation in sediment properties is apparent from samples, more extensive laboratory testing programs are required. The following tests are made in the field or in the laboratory to determine the geotechnical sediment properties:

a. **Material properties.** The material properties of the individual grains or particles are mineralogical composition, grain specific gravity, surface chemistry, size, shape, angularity, and water chemistry.

b. **Mass (intact) properties.** The position and arrangement of the soil particles in a sediment mass determine the mass properties: in situ density, water content, gas content, and structure.

c. **Behavior properties.** Behavior properties are a combined function of the material properties, the mass properties, and the applied external force system.

2.15.2 Material properties tests. The following tests determine material properties of the sediment and water components without reference to their arrangement in a sediment mass.

#### 2.15.2.1 Grain-size distribution.

a. The distribution of particle sizes is determined by screening the sediment through a set of sieves. The results are expressed in the form of an accumulative semi-log plot of percentage finer



versus grain diameter, as shown in Figure 2-17. Grain-size analysis consists of separating size classes by sieving for coarse-grained particles and by using the hydrometer for fine-grained particles. The standard particle analysis tests are performed using a weight basis instead of a volume basis. The use of screens to fractionate silt- and clay-sized particles smaller than about 0.075 mm (No. 200) is impractical because of the fineness of screens and their tendency to become clogged with particles. For that fraction of the soil, the sedimentation rate in water is used to establish quantities of various sizes. Detailed procedures for grain-size analysis can be found in EM 1110-2-1906 and ASTM D 422. The following useful values are determined from the grain-size distribution curve. For a detailed description of the classification uses of these size parameters, refer to ASTM D 2487.

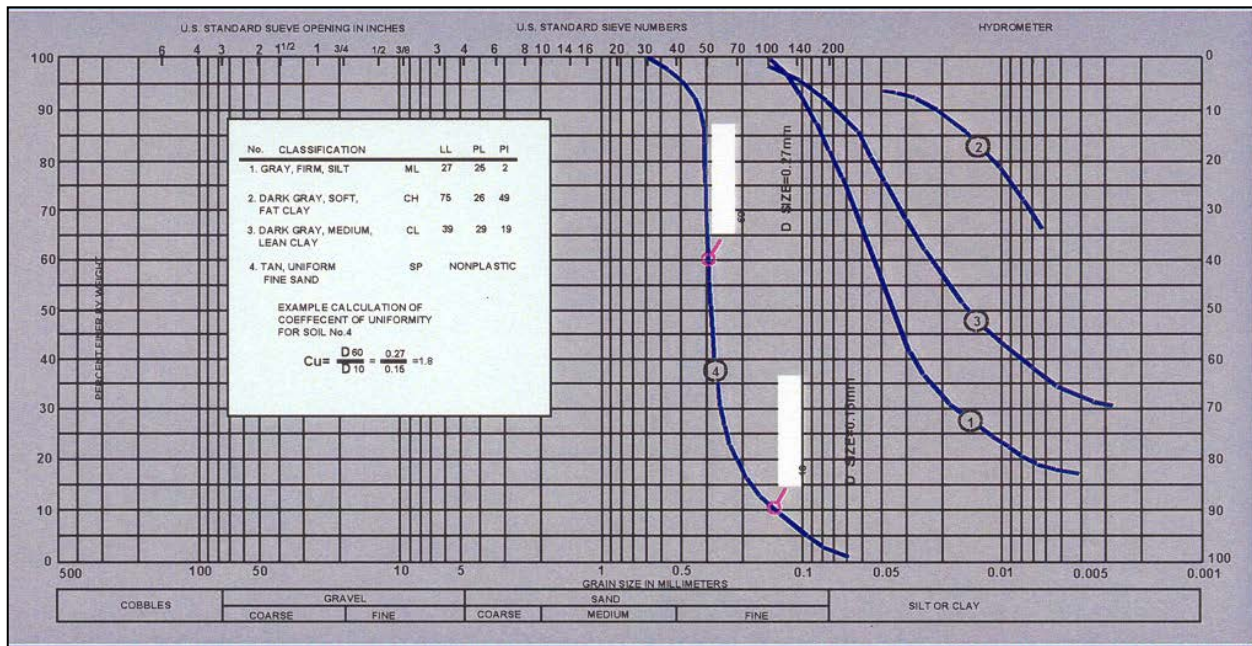

Figure 2-17. Typical Grain-Size Distribution Curves

- (1) Maximum grain size. Smallest screen size through which all particles can pass.
  - (2) Median grain size. Grain diameter  $d_{50}$ , corresponding to the 50% finer ordinate on the grain-size distribution curve.
  - (3) Effective size. Grain diameter  $d_{10}$ , corresponding to the 10% finer ordinate on the grain-size distribution curve.
  - (4) Coefficient of uniformity. Ratio of the  $d_{60}$  size (the grain size at which 60% of the grain size is finer) to the  $d_{10}$  size (the grain size at which 10% of the grain size is finer).
  - (5) Coefficient of curvature. Ratio of the square of the size to the product of the  $d_{30}$  (the grain size at which 30% of the grain size is finer) and  $d_{10}$  sizes.
- b. The USCS classification ranks (from largest to smallest) include boulders, cobbles, gravel, sand, silt, and clay. The grain sizes used in the USCS and familiar comparisons from

Sowers (1979) are presented in Table 2-3. As an alternative, grain size is often expressed in phi ( $\phi$ ) units, where  $\phi = -\log_2 D$  and where  $D$  equals the particle diameter in millimeters (Hobson 1979). This procedure normalizes the grain-size distribution and allows other size statistics based on normal distribution. This conversion is presented in Table 2-4.

Table 2-3. Grain-Size Identification (Modified from Spigolon 1993)

Classification	ASTM Grain-Size Limits
Boulder	>300 mm > 12 in.
Cobble	300–75 mm 12–3 in.
Coarse gravel	75–19 mm 3–0.75 in
Fine gravel	19–4.75 mm 0.75–No. 4
Coarse sand	4.75–2 mm No. 4–No. 10
Medium sand	2–0.425 mm No. 10–No. 40
Fine sand	0.425–0.075 mm No. 40–No. 200
Fine-grained soil	All material passing No. 200 screen (0.075 mm) is classified as fines (silt and clay).

#### 2.15.2.2 Plasticity.

a. The plasticity of the soil fraction that passes the No. 40 sieve (0.425 mm) reflects the combined influence of the mineralogy of the clay and the physicochemical interactions of the fine fraction of soils (Terzaghi and Peck 1967). A detailed explanation of the tests required to evaluate the plasticity of sediments is presented in EM 1110-2-1906 and ASTM D 4318. The Atterburg limits indicate the range of water content (the ratio of the weight of the water to the weight of the solids) over which the portion of a soil finer than 0.425 mm behaves in a plastic manner; the range is affected by the type and amount of clay mineral present. The upper limit of the range is defined as the liquid limit (LL), and the lower limit is defined as the plastic limit (PL). The LL is the water content at which the soil will just begin to flow when jarred in the prescribed manner. The PL is the water content at which the soil just begins to crumble when rolled into threads 3 mm (0.125 in.) in diameter. The plasticity index (PI) is calculated as the difference between the liquid limit and plastic limit water contents ( $PI = LL - PL$ ).

b. The Atterburg limits tests are expedient and inexpensive, making them a useful tool in fine-grained soil identification. Balling of clays in a dredging pipeline appears to be a direct function of the plasticity. Based on a chart developed by Casagrande (1948), the identification of the fine-grained fraction of soils in the Unified Soil Classification System (U.S. Army Engineer Waterways Experiment Station 1960) is based solely on the Atterburg limits, as shown in Figure 2-18.

Table 2-4. Sediment Particle Sizes

ASTM (Unified) Classification <sup>1</sup>	U.S. Std. Sieve <sup>2</sup>	Size in mm	Phi Size	Wentworth Classification <sup>3</sup>
Boulder		4096.	-12.0	
	12 in. (300 mm)	1024.	-10.0	Boulder
		256.	-8.0	Large Cobble
Cobble		128.	-7.0	
		107.64	-6.75	
	3 in. (75 mm)	90.51	-6.5	Small Cobble
		76.11	-6.25	
		64.00	-6.0	
		53.82	-5.75	
Coarse Gravel		45.26	-5.5	Very Large Pebble
		38.05	-5.25	
		32.00	-5.0	
		26.91	-4.75	
	3/4 in. (19 mm)	22.63	-4.5	Large Pebble
		19.03	-4.25	
		16.00	-4.0	
		13.45	-3.75	
		11.31	-3.5	Medium Pebble
		9.51	-3.25	
Fine Gravel	2.5	8.00	-3.0	
	3	6.73	-2.75	
	3.5	5.66	-2.5	Small Pebble
	4 (4.75 mm)	4.76	-2.25	
	5	4.00	-2.0	
Coarse Sand	6	3.36	-1.75	
	7	2.83	-1.5	Granule
	8	2.38	-1.25	
	10 (2.0 mm)	2.00	-1.0	
	12	1.68	-0.75	
	14	1.41	-0.5	Very Coarse Sand
	16	1.19	-0.25	
Medium Sand	18	1.00	0.0	
	20	0.84	0.25	
	25	0.71	0.5	Coarse Sand
	30	0.59	0.75	
	35	0.50	1.0	
	40 (0.425 mm)	0.420	1.25	
	45	0.354	1.5	Medium Sand
	50	0.297	1.75	
	60	0.250	2.0	
Fine Sand	70	0.210	2.25	
	80	0.177	2.5	Fine Sand
	100	0.149	2.75	
	120	0.125	3.0	
	140	0.105	3.25	
	170	0.088	3.5	Very Fine Sand
	200 (0.075 mm)	0.074	3.75	
Fine-grained Soil:	230	0.0625	4.0	
	270	0.0526	4.25	
Clay if PI $\geq$ 4 and plot of PI vs. LL is on or above "A" line and the presence of organic matter does not influence LL.	325	0.0442	4.5	Coarse Silt
	400	0.0372	4.75	
		0.0312	5.0	Medium Silt
		0.0156	6.0	Fine Silt
		0.0078	7.0	Very Fine Silt
		0.0039	8.0	Coarse Clay
Silt if PI < 4 and plot of PI vs. LL is below "A" line and the presence of organic matter does not influence LL.		0.00195	9.0	Medium Clay
		0.00098	10.0	Fine Clay
		0.00049	11.0	
(PI = plasticity limit; LL = liquid limit)		0.00024	12.0	
		0.00012	13.0	Colloids
		0.000061	14.0	

<sup>1</sup> ASTM Standard D 2487-92. This is the ASTM version of the Unified Soil Classification System. Both systems are similar (from ASTM (1994)).

<sup>2</sup> Note that British Standard, French, and German DIN mesh sizes and classifications are different.

<sup>3</sup> Wentworth sizes (in mm) cited in Krumbain and Sloss (1963).

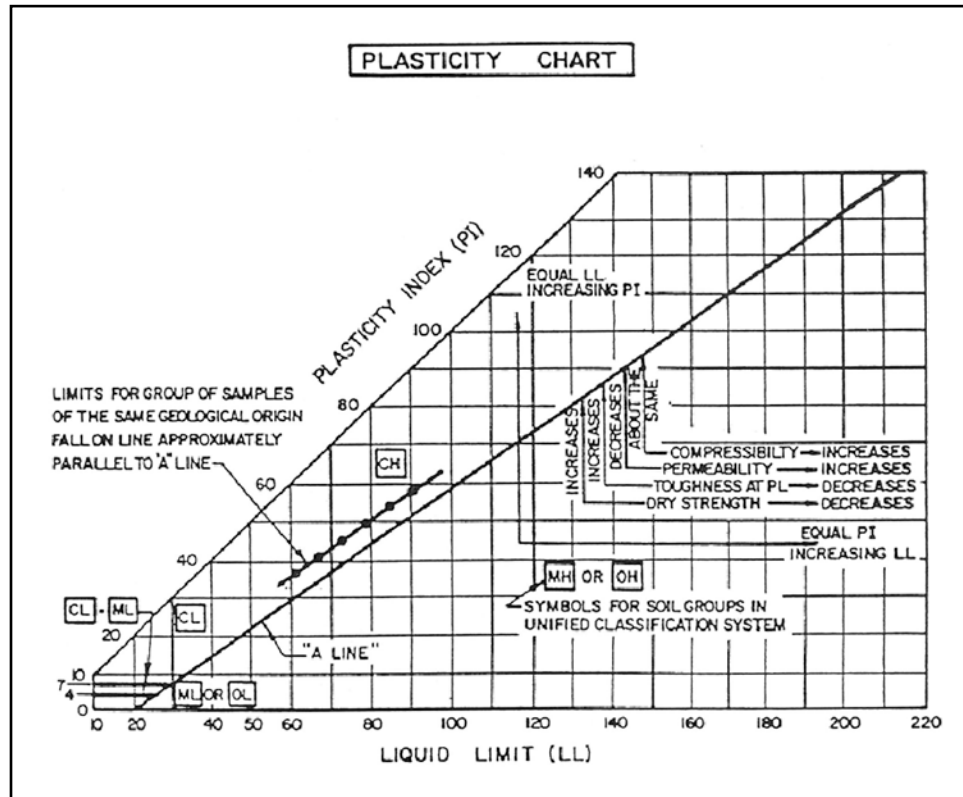

Figure 2-18. Casagrande Plasticity Chart for Cohesive Soils

c. The USCS is an outgrowth of the Airfield Classification System developed by Dr. Arthur Casagrande of Harvard University for the USACE during World War II. The Airfield Classification System was expanded and revised to apply to foundations and embankments as well as to airfields and roads. The USCS uses both textural qualities (particle-size characteristics) and plasticity characteristics as the basis of classification. Detailed information about the USCS, including the procedure for classification and the characteristics of each soil group, is found in U.S. Army Engineer Waterways Experiment Station (1960) and ASTM D 2487.

2.15.2.3 Specific gravity of solids. The specific gravity of the solid constituents of a soil is the ratio of the unit weight of the solids to the unit weight of water. While it does not indicate dredging behavior, specific gravity is essential for the calculation of void ratio and porosity. The other properties needed are in situ density and water content. These calculations involve determination of the density and volume of the soil solids as part of the total in situ volume. Procedures for conducting the specific gravity test are presented in EM 1110-2-1906 and ASTM D 854.

2.15.2.4 Color and odor. Soil color, while not of great consequence to the dredgeability of soils, is of considerable help in correlating soil samples from location to location during geotechnical analysis of the site investigation. In addition, the soil color can be of consequence in situations such as when dredged material is used for beach nourishment. Soil colors are often useful in detecting different strata, defining soil type based on experience in a local area, and possible identification of materials. Dark or drab shades of brown or grey and almost-black soils

are typically organic. However, some soils are black from other minerals. Brighter colors are associated with inorganic soils (Terzaghi and Peck 1967). Red, yellow, and yellowish brown colors suggest iron oxide whereas white and pink indicates silica, calcium carbonate, or aluminum compounds. Odor is an immediate and evident indicator of organics or chemical contents.

2.15.2.5 Organic content. Sediments may contain organic matter that affect the excavation and pumping processes. The organic content of a soil may be established in the laboratory by dry combustion using the ASTM D 2974 test method. The following dry combustion test procedure is recommended to determine the organic content expressed as the percentage of weight lost on ignition:

- a. Dry a 40 gram sample at 105° C until there is no further weight loss (usually 4 to 6 hours).
- b. Place the sample in a desiccator to cool for 15 minutes.
- c. Weigh the sample and place it in the oven at 440° C for 4 hours.
- d. Place the sample in the desiccator again to cool for 15 minutes.
- e. Weigh the sample and determine its organic content by dividing the weight lost by the sample while in the oven at 440° C by the total weight of the sample at the time it was placed in the oven.

### 2.15.3 Mass properties tests.

2.15.3.1 The mass properties are those relating to the arrangement of the material components. They include the relative positions of the soil grains, their structure, and their mass density. The soil material and soil mass properties are independent of each other. The same soil material can exist in a number of different arrangement states, and different soils can have the same water content, density, and other soil mass characteristics. The several mass properties defined below are interrelated. Calculations for weight-volume relationships are illustrated in Figure 2-19, and typical values for void ratio, saturated water content, and unit weight for natural soils in situ are given in Table 2-5. The tabulated values were taken from various published sources and are shown here for illustration only; actual measured values may differ slightly from those shown.

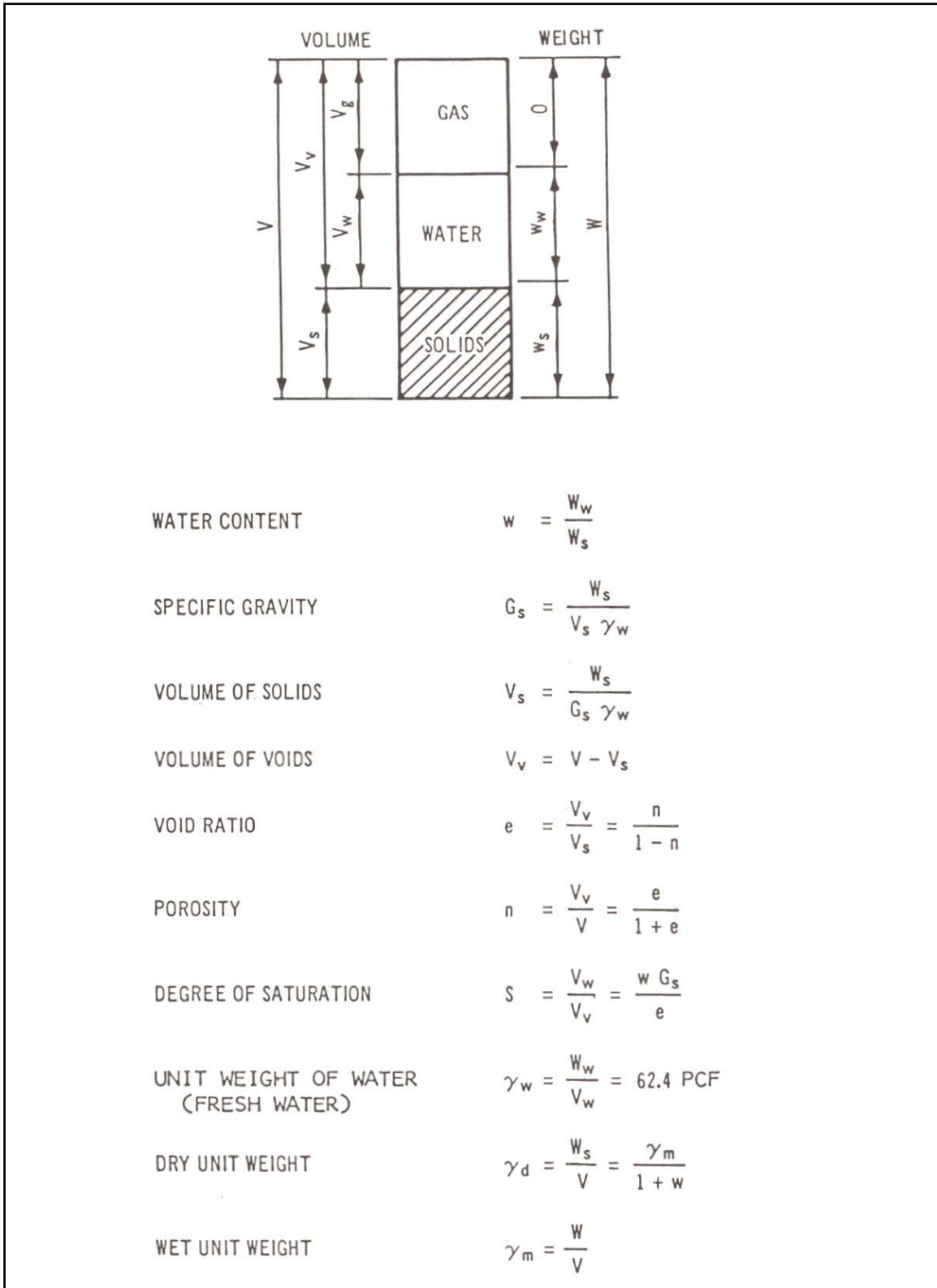

Figure 2-19. Weight-Volume Relationships (as Summarized by Spigolon 1993)

Table 2-5. Typical Weight-Volume Properties of Soils (as Summarized by Spigolon 1993)

Soil Description	State	Porosity n%	Void Ratio e	Water Con- tent w%	Unit Weight				Ref*
					Dry		Saturated		
					PCF	Kg/m <sup>3</sup>	PCF	Kg/m <sup>3</sup>	
Uniform spheres (theoretical)	Loose	48	0.92						HOU
	Dense	26	0.35						
Well-graded silty, sandy gravel	Loose	39	0.65	25	100	1600	125	2000	SOW
	Dense	20	0.25	10	132	2120	145	2320	
Glacial till, mixed gr.	Firm	20	0.25	10	132	2120	145	2320	PHT
Sand, mixed-grained	Loose	40	0.67	25	99	1590	124	1990	PHT
	Dense	30	0.43	16	116	1860	135	2160	
Well-graded sand, subangular	Loose	41	0.70	27	97	1560	123	1970	SOW
	Dense	30	0.35	14	122	1960	139	2230	
Well-graded sand, fine to coarse, clean	Loose	49	0.95	35	85	1360	115	1840	HOU
	Dense	17	0.20	7	132	2210	148	2370	
Uniform sand	Loose	46	0.85	31	90	1440	118	1890	PHT
	Dense	34	0.51	19	109	1750	130	2080	
Uniform sand, fine to medium, clean	Loose	50	1.00	37	83	1330	114	1830	HOU
	Dense	29	0.40	15	118	1890	136	2180	
Silty sand, well graded	Loose	47	0.90	33	87	1390	116	1860	HOU
	Dense	23	0.30	12	127	2040	142	2280	
Sand & silt, micaceous	Loose	56	1.25	47	75	1200	110	1760	SOW
	Dense	44	0.80	30	94	1510	122	1960	
Windblown silt (loess)	Firm	50	0.99	36	85	1360	116	1860	PHT
Uniform inorganic silt	Loose	52	1.10	41	80	1286	113	1810	HOU
	Dense	29	0.40	15	118	1890	136	2180	
Organic silt	Loose	75	3.00	118	40	640	87	1390	HOU
	Dense	35	0.55	19	110	1760	131	2100	
Sandy or silty clay	Soft	64	1.80	67	60	960	100	1600	HOU
	Stiff	20	0.25	9	130	2160	147	2360	
Glacial clay	Soft	55	1.20	45	76	1220	110	1760	PHT
	Stiff	37	0.60	22	106	1700	129	2070	
Clay (30-50% clay sizes)	Soft	71	2.40	88	50	800	90	1510	HOU
	Stiff	33	0.50	19	112	1800	133	2130	
Slightly organic clay	Soft	66	1.90	69	58	930	98	1570	PHT
Very organic clay	Soft	75	3.00	107	43	690	89	1430	PHT
Organic clay (30- 50% clay sizes)	Soft	81	4.40	170	30	480	81	1300	HOU
	Stiff	41	0.70	25	100	1600	125	2000	
Montmorillonitic clay	Soft	84	5.20	196	27	430	80	1280	PHT

\* HOU = Hough (1957), PHT = Peck, Hanson, and Thornburn (1974), SOW = Sowers (1979).

2.15.3.2 Water content. The water content is expressed on a dry weight basis as follows:

$$w = \frac{W_w}{W_s} \times 100 \text{ percent} \quad (2-1)$$

where

$w$  = water content, percent

$W_w$  = weight of water in the sample, grams

$W_s$  = weight of solids in the sample, grams

The term “water content,” as used in this manual, refers to the engineering water content commonly used in geotechnical engineering and may exceed 100%. It is used to determine the in situ void ratio and in situ density of fine-grained sediments. Water content determinations should be made on representative samples from borings and grab samples of fine-grained sediment obtained during field investigation. Fine-grained sediments do not drain rapidly; thus, representative samples taken from borings and grab samples are considered to represent in situ water contents. Detailed test procedures for determining the water content are found in EM 1110-2-1906 and ASTM D 2216. Water content is an important factor used in sizing dredged material containment areas, and its application for sizing containment areas is presented in Chapter 4, “Confined (Diked) Placement.”

2.15.3.3 Void ratio. Void ratio is calculated as the ratio of the volume of the void space, including water and gas, in a soil mass to the volume of the solid constituents. Porosity is calculated as the ratio of the volume of voids in a soil mass to the total volume of soil, which includes gas, water, and solids. Void ratio is used in geotechnical engineering because of its value in further calculations involving weight-volume relations. Detailed test procedures for determining porosity are found in EM 1110-2-1906.

2.15.3.4 In situ (mass) density. In situ density is used to evaluate dredgeability of sediments and aid in equipment selection, to estimate production rates, and to estimate volume required for storage in confined disposal areas. The mass density (unit weight) is the total weight per unit of volume. Wet density (wet unit weight) is defined as the total weight of gas, water, and soil solids per unit of volume of the soil. Dry density (dry unit weight) is the dry weight of solids per unit volume of the soil. Saturated density (saturated unit weight) is the total weight of water and soil solids per unit of soil volume when the void space contains only water (no gas). With the water content and unit weight of a sample known, the solids (dry) density can be calculated. With the addition of specific gravity of solids (grains), the solids volume and gas content can be determined. There are several methods for determining or estimating the in situ density of a soil. It can be estimated from laboratory test data using geotechnical engineering formulas or from field investigations of sediments (see paragraphs 2.13.5.3, 2.13.5.4, and 2.13.5.5). Relatively undisturbed samples may be taken from soft to stiff cohesive sediments by using a thin-walled sampling tube inserted into the soil slowly and without impact as described in ASTM D 1587. Obtaining high-quality undisturbed samples of sand has been rather elusive (EM 1110-1-1906).



Refer to Appendix II of EM 1110-2-1906 for guidance in estimating in situ density from laboratory tests.

2.15.4 Behavior properties tests. Behavior properties are a combined function of the material properties, the mass properties, and an applied external force system. The soil behavior properties influence dredgeability, placement and containment design, and feasibility of dredged material beneficial uses.

2.15.4.1 Relative density and consistency. The relative density of noncohesive soils and relative firmness, or consistency, of cohesive soils can be estimated by in situ testing from the Standard Penetration Test (SPT) and the Cone Penetration Test (CPT). Relative density is defined in ASTM D 653 as “the ratio of the difference between the void ratio of a cohesionless soil in the loosest state and any given void ratio, to the difference between the void ratios in the loosest and in the densest states.”

a. Standard Penetration Test. The SPT consists of driving a split-barrel sampler (Figure 2-15) to obtain a representative disturbed sample while simultaneously obtaining a measure of the resistance of the subsoil to penetration of a standard sampler. The resistance to penetration is obtained by counting the number of blows required to drive a steel tube of specified dimensions into the subsoil a specified distance using a hammer of a specified weight (mass). The soil sample obtained as a part of the test can be used for water content determination, soil type identification purposes, and laboratory tests in which the degree of disturbance of the sample does not adversely affect the results. The results of the SPT have been used extensively in many geotechnical exploration projects. The SPT blow count  $N$  is a measure or index of the in-place firmness or denseness of the foundation material. Many local and widely published correlations that relate SPT blow count to the engineering behavior of earthworks and foundations are available. Because the SPT is considered to be an index test, blow count data should be interpreted by experienced engineers only. In general, the SPT blow count data are applicable to fairly clean medium-to-coarse sands and fine gravels at various water contents and to saturated or nearly saturated cohesive soils. When cohesive soils are not saturated, the penetration resistance may be misleading as to the behavior of the material as a foundation soil. Likewise, the engineering behavior of saturated or nearly saturated silty sands may be underestimated by the penetration resistance test. The relative firmness or consistency of cohesive soils or density of cohesionless soils can be estimated from the blow count data, which is presented in Table 2-6 (EM 1110-1-1906). Where no field tests are performed on coarse-grained materials (for example, sand or gravel) the material in its densest state, based on laboratory tests, will be considered comparable to its in situ condition. Correct standardization of procedures and equipment (the hammer size and drop) for the SPT are described in EM 1110-1-1906 and ASTM D 1586.

Table 2-6. Soil Density or Consistency from Standard Penetration Test Data  
(from EM 1110-1-1906 after Terzaghi and Peck 1948)

<u>Cohesive Soil</u>		
Consistency	Blows/foot (0.3048 m)	Unconfined Compressive Strength <sup>1</sup>
Very soft	Less than 2	Less than 25 kPa (0.25 tsf).
Soft	2 to 4	25 to 50 kPa (0.25 to 0.5 tsf)
Medium	4 to 8	50 to 100 kPa (0.5 to 1.0 tsf)
Firm	8 to 15	100 to 190 kPa (1.0 to 2.0 tsf)
Very firm	15 to 30	190 to 380 kPa (2.0 to 4.0 tsf)
Hard	Greater than 30	Greater than 380 kPa (4.0 tsf)
<u>Cohesionless Soil</u>		
Density	Blows/foot (0.3048 m)	
Very loose	Less than 4	
Loose	4 to 10	
Medium dense	10 to 30	
Dense	30 to 50	
Very dense	Greater than 50	

<sup>1</sup> The unconfined compressive strength may be approximated by the pocket penetrometer or the vane shear apparatus.

b. Cone Penetration Test. The CPT can provide detailed information on soil stratigraphy and preliminary estimations of geotechnical properties (EM 1110-1-1804). The CPT may also be used to estimate both relative density of cohesionless soil and undrained strength of cohesive soil through empirical correlations. The CPT is especially suitable for sands and preferable to the SPT (EM 1110-1-1905). This measurement method is performed by slowly pushing a rod with an enlarged cone tip into the soil and measuring the force required for penetration. ASTM D 3441 covers the standard test method for mechanical CPTs of soil. On land, a typical force reaction is a 20 ton truck while various devices have been developed for performing CPTs over water by using a reaction frame resting on the sea bottom or by modifying land CPT rigs for use on jack-up barges.

2.15.4.2 Bulking factor. A bulking factor is the ratio of the volume occupied by a given amount of dredged material in a containment area in either a hopper or a placement area immediately after deposition by a dredging process to the volume occupied by the same amount of soil in situ. The bulking factor is affected by soil material, mass, and behavior characteristics as well as different types of dredges and dredging techniques. Granular materials may increase or decrease volume, depending on the initial density state (loose or dense) and the final deposition manner. The volume of cohesive soils tends to increase upon removal from their in situ position. Hydraulic dredges usually bulk up sediment more than mechanical dredges due to water entrainment. New-work material tends to have higher initial bulking in the placement area than

maintenance material because it is usually in a more consolidated in situ state. A general rule of thumb is the larger the grain size, the lower the bulking factor (sand 1.0 to 1.2, silt 1.2 to 1.8, and clay 1.5 to 3.0).

2.15.4.3 Shear strength of soil. Shear strength of dredged material is an important parameter for estimating dredgeability and modeling sediment behavior under applied stress loading, especially when predicting mounding stability and confined aquatic disposal site stability. Laboratory testing includes laboratory vane shear testing (ASTM D 4648) or field vane shear testing (ASTM D 2573), and Undrained Unconsolidated (UU) triaxial testing (ASTM D 6528) for cohesive material.

2.15.4.4 Unconfined compressive strength of rock. The rock property commonly accepted for indicating strength, rippability, and dredgeability is the Unconfined Compressive Strength (UCS). An intact rock core is required for preparation and testing in a high-capacity compression testing machine and tested to failure. Cored rock samples are retrieved by rotary drilling with hollow-core barrels equipped with diamond- or carbide-embedded bits. The core is commonly retrieved in 1.5-3 m (5-10 ft) lengths. The “N” size hole (approximately 75 mm [3 in.]), probably the core size most widely used by the USACE for geotechnical investigations, produces a satisfactory sample for preliminary exploration work and, in many instances, for more advanced design studies. Boring methods, techniques, and applications are described in EM 1110-1-1804 and EM 1110-1-1906. A standard practice for rock core drilling and sampling of rock for site investigation is provided in ASTM D 2113, and a standard test method for conducting an unconfined compressive strength of intact rock core specimens is provided in ASTM D 2938.

2.15.4.5 Rock Quality Designation. Another indicator of dredgeability of rock can be the Rock Quality Designation, which indicates the percentage of intact and sound rock in the core run. It was first used to provide a simple and inexpensive indicator of rock mass quality to predict tunneling conditions (ASTM D 6032) and has been used to indicate rock quality for predicting dredgeability (Johnson and Sraders 2003). The Rock Quality Designation is calculated where “all pieces of intact and sound rock core equal to or greater than 100 mm (4 in.) long are summed and divided by the total length of the core run” (ASTM D 6032).

## 2.16 Laboratory Tests for Containment Facilities.

2.16.1 In addition to the sediment material, mass, and behavior properties presented above, additional laboratory tests (consolidation testing, water salinity, and/or solids concentration) may be required to provide data for containment area design and long-term storage capacity estimates. A flowchart illustrating the complete laboratory testing program for a containment facility design is shown in Figure 2-20.

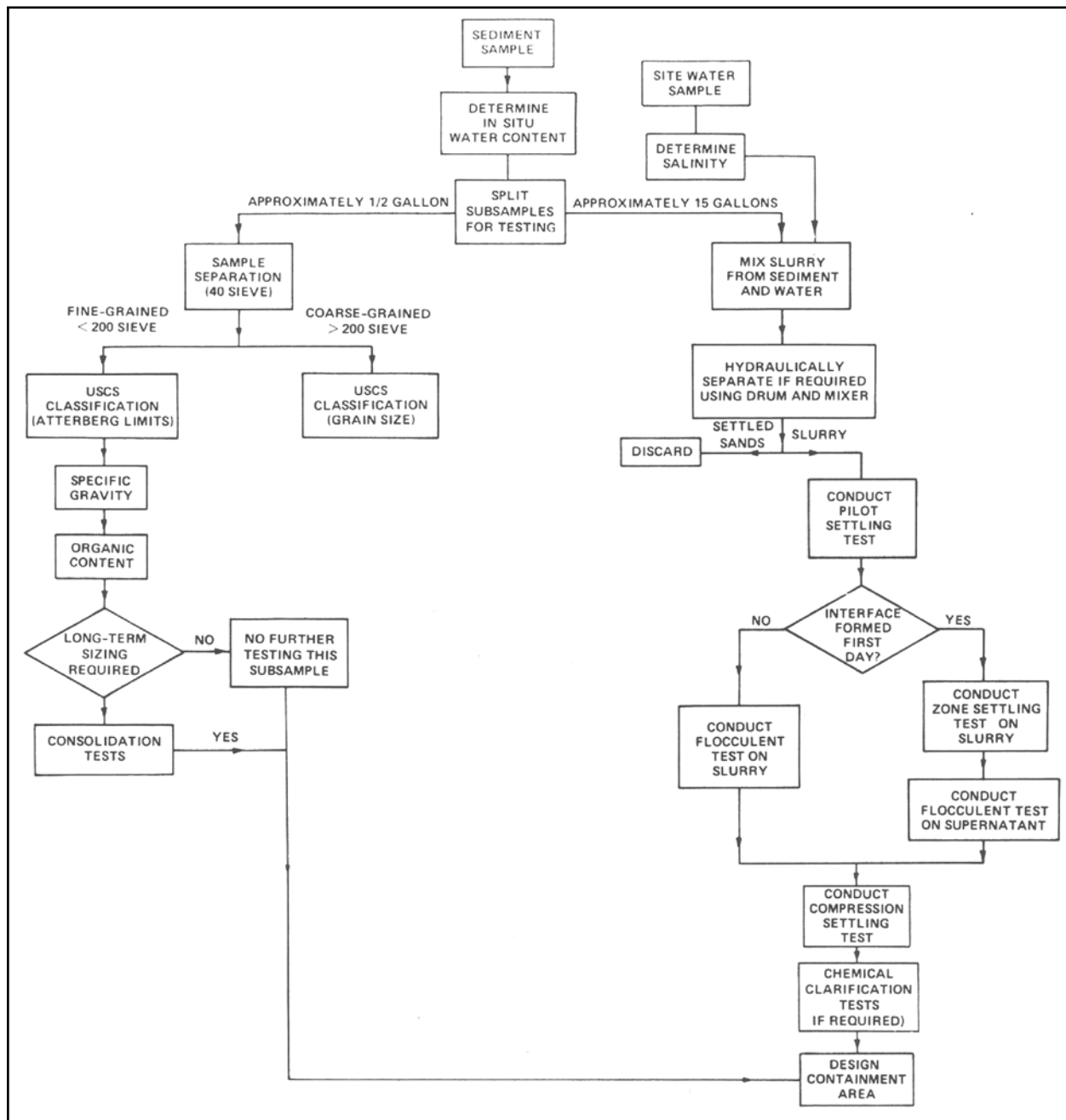

Figure 2-20. Flowchart Depicting Laboratory Testing for Containment Area Design

2.16.2 Consolidation testing. Sediment consolidation testing may be required for containment area design and long-term storage capacity estimates. Consolidation analysis of soft dredged material requires that laboratory compressibility data be obtained across the entire wide range of void ratios that are commonly encountered in these soft materials as they consolidate. Void ratios in dredged materials can vary much more than those of normal soils. In typical (nonsediment) soils in the natural state, void ratios normally vary between 0.25 and 2.0, with some soft organic clays reaching 3.0. Recently deposited in situ sediments often have void ratios

as high as 5 or 6, double or triple the values of most soils. When dredged by hopper or hydraulic dredges, the initial void ratios after placement may reach as high as 10 to 12; in a few clayey sediments, the maximum values may reach even higher. Mechanical dredging does not dramatically alter the void ratio of the mass of dredged material; however, there will be clumps of material at about the in situ void ratio with much softer (slurry consistency) material between the clumps. Laboratory consolidation testing of soft materials often requires use of at least two types of consolidation tests. Both a modified version of the standard oedometer consolidation test and a self-weight consolidation test must normally be conducted; these tests provide data for the low and high ends of the anticipated range of void ratios, respectively. However, on relatively firm dredged materials that are mechanically dredged, use of oedometer testing alone may suffice. Detailed guidance concerning consolidation testing for containment area design and long-term storage capacity is provided in Chapter 4, "Confined (Diked) Placement."

2.16.3 Salinity. Near-bottom water samples from the area where water will be mixed with sediment during the dredging or pump-out operation (usually water at the dredging site) may be tested for salinity. In estuarine environments, the salinity may vary with depth, flow, wind, tidal cycle, and season. Therefore, it is important to know the expected range of salinity during the dredging project. If the water at the dredging site is saline (>1 part per thousand), water gathered during the field investigation or reconstituted salt water should be used when additional water is required in all subsequent characterization tests and in the settling tests. Salinity may be measured in two ways:

a. Conductivity. Salinity may be measured directly by a salinity conductivity meter that electronically converts temperature-adjusted electrical conductivity into salinity.

b Dissolved solids or nonfilterable residue. A detailed procedure is presented in American Public Health Association (1985). Briefly, it consists of the following steps:

(1) Filter water through a filter with a pore size of 1 micron or less.

(2) Pipette a known volume (about 25 milliliters) into a weighed dish and evaporate the sample for 4 to 6 hours in a drying oven at 103° to 105° C.

(3) Cool the dish in a desiccator and then weigh it immediately.

(4) Salinity (in parts per thousand [ppt]) is equal to the residue (in milligrams) divided by the sample (in milliliters).

#### 2.16.4 Solids concentration.

2.16.4.1 General. The suspended solids concentration is the most frequently measured parameter in the laboratory procedures. This measurement is made during preparation of slurries and suspensions and during evaluation of settling characteristics, treatment effectiveness, and other items. Three methods may be used to measure suspended solids: evaporation, filtration, and centrifugation. Each is applicable under different circumstances. Evaporation (direct drying) measures total solids (that is, the sum of both suspended and dissolved solids). The dissolved solids concentration, if significant, must be measured separately and subtracted from the total

31 Jul 15

solids concentration. Filtration directly measures suspended solids. Centrifugation is a blend of the other two methods. It attempts to measure suspended solids by measuring the total solids after washing the dissolved solids out of a known volume of sample. The procedures outlined below are adapted from the methods given in Palermo, Montgomery, and Poindexter (1978). In practice, there has been confusion concerning the method of reporting suspended solids. The terms “concentration in grams per liter,” “percent solids by weight,” “percent solids by volume,” and “percent solids by apparent volume” have been used. These methods of reporting suspended solids concentration are discussed and compared in Table 2-7. The relationship of percent suspended solids by weight and volume, concentration in grams per liter, and water content is illustrated in Figure 2-21. This figure does not, however, account for salinity in the sample. Suspended solids concentration in grams per liter or milligrams per liter is used throughout this manual. If suspended solids determinations are to be made on samples with a solids concentration of 1 gram or less per liter, either the centrifugation method or the filtration method should be used. For slurries with solids concentrations of 1 gram or more per liter, either the total solids method or the centrifugation method should be used.

#### 2.16.4.2 Definitions and conversions.

a. The percent of total solids by weight is the weight of solids both nonfilterable and filterable (both dissolved and suspended) in a sample divided by the weight of the sample:

$$\%S = \frac{W_s}{W_t} (100 \text{ percent}) \quad (2-2)$$

where

$\%S$  = percent total solids by weight, percent

$W_t$  = total weight of sample, grams

Table 2-7. Relationship of Concentration in Percent Solids by Weight, Percent Solids by Volume, Concentration in Grams per Liter, and Water Content

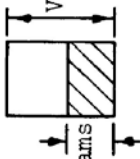
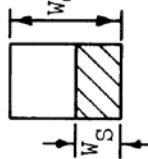
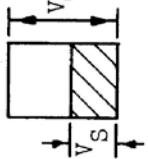
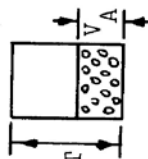
Method of Reporting Suspended Solids	Weight-Volume Relationship	Method of Computation	Remarks
grams per litre or milligrams per litre	 <p><math>V_T = 1 \text{ litre}</math> <math>W_S, \text{ grams}</math></p>	<p><math>S = \frac{W_S}{V_T}</math></p> <p><u>Preferred Method</u></p>	Common method for reporting dissolved chemical concentrations. Best method for engineering purposes
percent by weight		<p><math>S = \frac{W_S}{W_T} 100</math></p> <p><u>Other Methods</u></p>	Easy to determine by laboratory test. Does not require value for specific gravity
percent by volume		<p><math>S = \frac{V_S}{V_T} 100</math></p>	Easy to determine by laboratory test. Requires determination of percent by weight and value for specific gravity
percent by apparent volume	 <p><math>V_A = V_S + V_I</math></p>	<p><math>S = \frac{V_A}{V_T} 100</math></p>	Apparent volume determined by settled solids for a bottle or flask. No standardized procedure available. Void ratio of settled solids varies with type of sediment. Can lead to errors because of nonstandard test. Not recommended. Value is meaningless in engineering calculations
<p>Note: <math>W_S</math> = oven-dry weight of solid particles  <math>V_T</math> = total volume  <math>W_T</math> = total weight  <math>V_S</math> = volume of solid particles  <math>V_A</math> = apparent volume of settled solids  <math>V_I</math> = volume of interstitial water</p>			

31 Jul 15

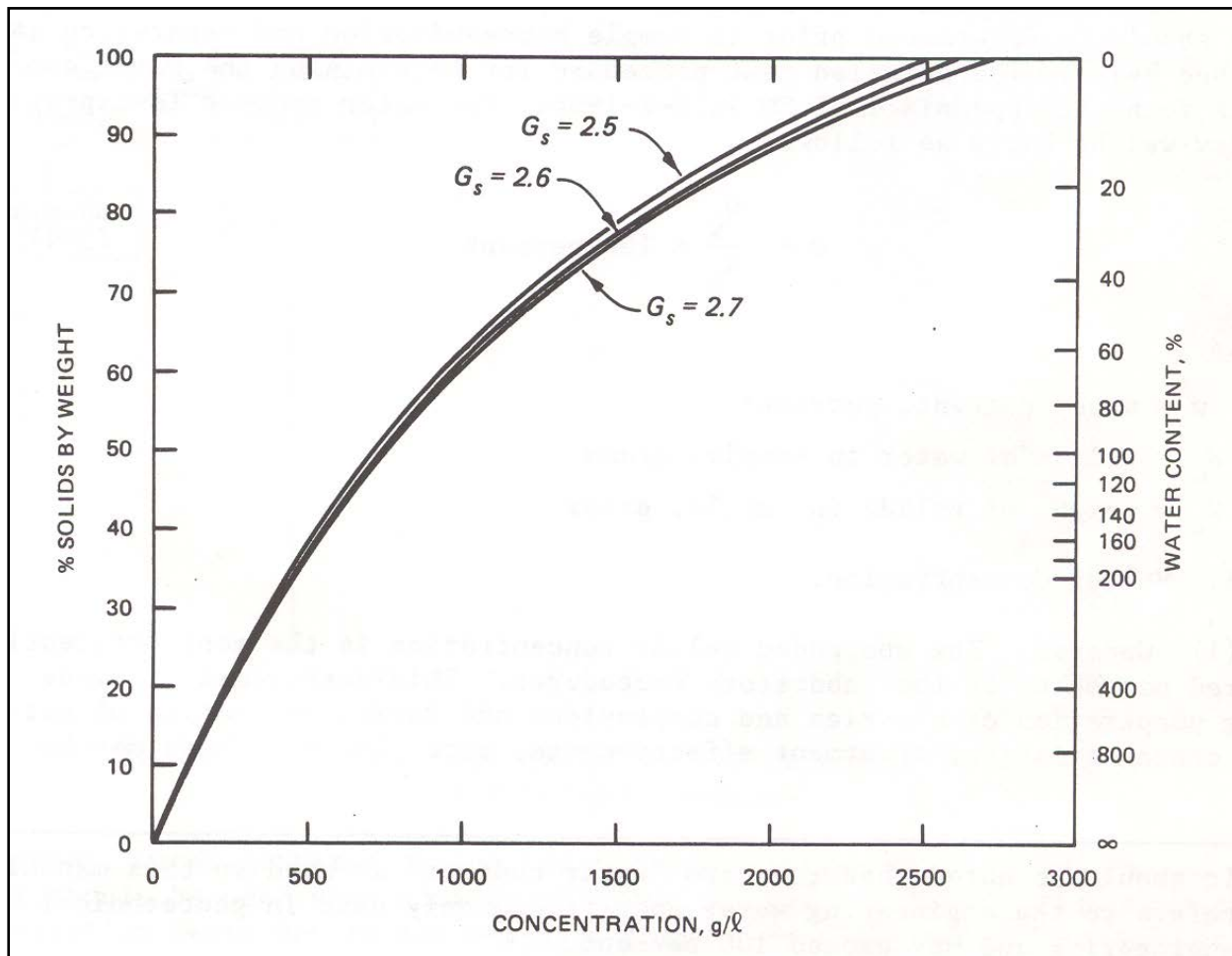

Figure 2-21. Relationship of Concentration in Percent Solids by Weight, Percent Solids by Volume, Concentration in Grams per Liter, and Water Content

b. The percent of suspended solids by weight is the weight of solids less the weight of dissolved solids in a sample divided by the weight of the sample:

$$\%SS = \frac{W_s - \frac{(W_w \text{ Sal})}{1,000}}{W_t} (100 \text{ percent}) \quad (2-3)$$

where

%SS = percent suspended solids by weight, percent

$W_w$  = weight of wet sample and dish, grams - weight of dry sample and dish, grams

Sal = salinity, parts per thousand



c. Solids concentration is the weight of solids (dissolved and suspended) in a sample divided by the volume of sample:

$$C_s = \frac{W_s}{V_t} \quad (2-4)$$

where

$C_s$  = solids concentration, grams per liter

$V_t$  = sample volume, liters

d. Suspended solids concentration is the weight of suspended solids in a sample divided by the volume of sample:

$$C = \frac{W_{ss}}{V_t} \quad (2-5)$$

where

$C$  = suspended solids concentration, grams per liter

$W_{ss}$  = weight of suspended solids in sample, grams, calculated as

$$W_{ss} = W_s - W_w \left( \frac{Sal}{1,000 \text{ ppt}} \right)$$

e. The percent of suspended solids by weight may be converted to concentrations in units of grams per liter by the following formula:

$$C = \frac{(1,000 \text{ g/L}) G_s \left[ 1 + \left( \frac{Sal}{1,000 \text{ ppt}} \right) \right]}{G_s \left[ \left( \frac{100\%}{\%SS} \right) - 1 \right] + \left[ 1 + \left( \frac{Sal}{1,000 \text{ ppt}} \right) \right]} \quad (2-6)$$

where  $G_s$  is the specific gravity of suspended solids particles.

f. Suspended solids concentrations presented in units of grams per liter may be converted to percent of suspended solids by the following formula:

$$\%SS = \frac{100\% G_s \left( \frac{C}{1,000 \text{ g/L}} \right)}{G_s \left( \frac{C}{1,000 \text{ g/L}} \right) + \left[ G_s - \left( \frac{C}{1,000 \text{ g/L}} \right) \right] \left[ 1 + \left( \frac{Sal}{1,000 \text{ ppt}} \right) \right]} \quad (2-7)$$

g. Suspended solids concentrations  $C_{ss}$  can be calculated from total solids concentrations by the following equations if the salinity is known and the total solids concentration is presented in percent of solids by weight:

$$\%SS = \%S - \left[ (100\% - \%S) \left( \frac{Sal}{1,000 \text{ ppt}} \right) \right] \quad (2-8)$$

$$\%S = \frac{\%SS + 100\% \left( \frac{Sal}{1,000 \text{ ppt}} \right)}{1 + \left( \frac{Sal}{1,000 \text{ ppt}} \right)} \quad (2-9)$$

$$C_{ss} = \frac{(1,000 \text{ g/L}) G_s \left[ 1 + \left( \frac{Sal}{1,000 \text{ ppt}} \right) \right]}{\left[ 1 + \left( \frac{Sal}{1,000 \text{ ppt}} \right) \right] + G_s \left\{ \frac{-1 + 1}{\left[ \left( \frac{\%S}{100\%} \right) \left( 1 + \frac{Sal}{1,000 \text{ ppt}} \right) - \left( \frac{Sal}{1,000 \text{ ppt}} \right) \right]} \right\}} \quad (2-10)$$

2.16.4.3 Total solids method (evaporation method). This test is used when the suspended solids concentration is large compared to the dissolved solids. It also may be used in other cases where the dissolved solids or salinity is known or measured separately. To ensure accuracy, the test should generally be used only for a suspension with a suspended solids concentration greater than 1 gram per liter. These steps should be followed:

- a. Obtain the tared weight of a sample dish.
- b. Thoroughly mix the sample and pour it into the sample dish.
- c. Weigh the dish and the sample and place them in a drying oven at 105° C until the sample has dried to a constant weight (about 4 to 6 hours).
- d. Cool the sample in a desiccator and then it weigh immediately.

e. Calculate the suspended solids concentration  $C$  in grams per liter, as follows:

$$C = \frac{W_{ss}(1,000 \text{ g/L})}{\left(\frac{W_{ss}}{G_s}\right) + W_w} \quad (2-11)$$

from before

$$W_{ss} = W_s - [W_w (\text{Sal}/1,000 \text{ ppt})]$$

$W_s$  = weight of the dry sample and dish - the weight of the dish

$Sal$  = salinity, ppt, or dissolved solids, grams per liter; if unknown in freshwater environments, use zero

$G_s$  = specific gravity of the solids; use 2.67 if unknown

$W_w$  = weight of the wet sample and dish, grams - weight of the dry sample and dish, grams

2.16.4.4 Filtration method. This method should be used for suspensions having suspended solids concentrations of less than 1.0 gram per liter. Any quantitative filtering apparatus using a filter paper that has a pore size of 1 micron or less can be used for the test. The two most common setups use either a Gooch crucible with a glass fiber filter paper or a membrane filter apparatus. These steps should be followed:

- a. Weigh the filter.
- b. Filter a measured volume of the sample. The volume should be sufficient to contain 5 milligrams of suspended solids.
- c. Filter 10 milliliters of distilled water twice to wash out the dissolved solids.
- d. Place the filter in a drying oven at 105° C until the sample has dried to constant weight (usually 1 to 2 hours).
- e. Cool the sample in a desiccator and then weigh it.
- f. Calculate the suspended solids concentration  $C$  in grams per liter, as follows:

$$C = \frac{\left[ (\text{weight of filter and dry solids, grams}) - (\text{weight of filter, grams}) \right]}{(1,000 \text{ ml/L}) \times (\text{volume of sample, ml})} \quad (2-12)$$

2.16.4.5 Centrifugation method. This method is recommended for samples from saltwater environments that have a suspended solids concentration greater than 1 gram per liter. It is

31 Jul 15

particularly useful when the dissolved solids concentration or salinity is unknown but is expected to be significant (greater than 10% of the suspended solids concentration). This method is preferable to the total solids method when the dissolved solids concentration is several times greater than the suspended solids concentration. These steps should be followed:

- a. Centrifuge a measured volume of sample until the liquid and solids have separated, yielding a clear supernatant (several minutes should be sufficient).
- b. Pour off the supernatant, being careful not to lose any of the solids.
- c. Resuspend the settled solids in distilled water by diluting the sample to its initial volume.
- d. Repeat steps a-d twice to wash out all dissolved solids.
- e. Pour the sample into a preweighed dish, and then wash all remaining solids from the centrifuge tube into the dish, using distilled water.
- f. Place the dish in a drying oven at 105° C until the sample has dried to a constant weight (usually 4 to 6 hours).
- g. Cool the sample in a desiccator and then weigh it.
- h. Calculate the suspended solids concentration  $C$  in grams per liter, as follows:

$$C = \frac{[(\text{weight of dish and dry solids, grams}) - (\text{weight of dish, grams})]}{(1,000 \text{ ml/L}) \times (\text{volume of sample, ml})} \quad (2-13)$$

2.16.4.6 Correlation of suspended solids with turbidity. In some cases, effluent quality standards are specified in terms of turbidity, an optical property. Relationships between suspended solids concentration and turbidity are sediment-specific and can be determined only by preparing a correlation curve. The correlation curve is developed by determining turbidity and suspended solids concentration of samples prepared over a sufficiently wide range of concentrations.

#### 2.16.5 Sample compositing and separation.

2.16.5.1 Following determination of in situ water content, the sediment sample(s) must be homogenized, split, and possibly separated into coarse- and fine-grained fractions prior to further testing. Sediment characterization tests—such as plasticity, grain-size determination, specific gravity, and organic content—may be performed on grab samples from each of several sampling locations. Other tests, such as consolidation and settling tests, should be performed on an appropriately composited and homogenized sample. The need for and methods of compositing are highly project dependent, but they should be aimed toward producing a sample for testing that is representative of the material to be dredged. If composite samples are to be used for further testing, they must be thoroughly mixed. Samples for settling tests (approximately 3.8 L [15 gallons]) may require addition of some water to aid in mixing.

2.16.5.2 Sediment character, as determined from in situ samples, is not indicative of dredged material behavior after dredging since the fine-grained (<No. 200 sieve) fraction undergoes natural segregation within the containment area and behaves independently of the coarse-grained (>No. 200 sieve) fraction. Therefore, the relative percentage (dry weight basis) of coarse- and fine-grained material should be determined by separation of a small portion of the sample, using a No. 200 sieve and following procedures generally described in EM 1110-2-1906.

2.16.5.3 If the coarse-grained fraction is less than 10% by dry weight, the sediment sample is considered to be fine grained and is treated as though all the material passed the No. 200 sieve; separation for further characterization tests is not required. If the coarse-grained fraction is greater than 10% by dry weight, the entire sample should be separated into coarse- and fine-grained fractions prior to further testing. Separation can be accomplished for small sample volumes (for example, those intended for classification or consolidation testing) by using the No. 200 sieve as described above. However, the larger sample volume required for sedimentation tests makes the use of a sieve impractical. For such volumes, slurry (sediment plus water) can be thoroughly mixed in a large barrel and then allowed to separate by differential settling. After the initial mixing is stopped, the coarse material quickly accumulates on the bottom. The slurry remaining above the coarse material can then be pumped into a second barrel, where it can be remixed and loaded into the testing column.

2.16.5.4 The various tests as well as sample separation and preparation require slurries of various solids concentrations. It is advisable to begin the testing sequence with a slurry of higher concentration and add the required volume of water to obtain the desired lower concentration. The following simple relationship is useful in calculating the volume of additional water required:

$$C_1V_1 = C_2V_2 \quad (2-14)$$

where

$C_1$  and  $C_2$  = solids concentrations

$V_1$  and  $V_2$  = slurry volumes (water plus solids).

2.16.6 Settling tests. Dredged material placed in placement areas by hydraulic dredges or pumped into placement areas by pump-out facilities enters the placement area as a slurry (mixture of dredged solids and dredging site water). Settling refers to those processes in which the dredged material slurry is separated into supernatant water of low solids concentration and a more concentrated slurry. Laboratory sedimentation tests provide data for designing the containment area to meet effluent suspended solids criteria and to provide adequate storage capacity for the dredged solids. These tests are described in detail in Chapter 4, "Confined (Diked) Placement."

## 2.17 Site Contamination Characterization.

2.17.1 In the technical framework, the initial screening for sediment contamination is designed to determine, based on available information, if the sediments to be dredged contain

any contaminants in forms and concentrations that are likely to cause unacceptable impacts to the environment. During this screening procedure, specific contaminants of concern are identified in a site-specific sediment, so that any subsequent evaluation is focused on the most pertinent contaminants. Initial considerations should include, but are not limited to, the following:

a. Potential routes by which contaminants could reasonably have been introduced to the sediments.

b. Data from previous sediment chemical characterization and other tests of the material or other similar material in the vicinity, provided the comparisons are still appropriate.

c. Probability of contamination from agricultural and urban surface runoff.

d. Spills of contaminants in the area to be dredged.

e. Industrial and municipal waste discharges (past and present).

f. Source and prior use of dredged materials (for example, beach nourishment).

2.17.2 When testing is necessary, samples of dredged material, reference sediment, control sediment, organisms, and water are needed for physical evaluations, chemical analysis, and bioassay tests. “Evaluation of Dredged Material Proposed for Discharge in Waters of U.S. – Testing Manual” (USEPA/USACE 1998) and “Evaluation of Dredged Material Proposed for Ocean Disposal–Testing Manual” (USEPA/USACE 1991) (described in Chapter 3, “Open-Water Placement,” and Chapter 4, “Confined [Diked] Placement”) provide general guidance for the development of a sampling plan, including collection, handling, and storage. Sampling is the foundation upon which all testing rests, but there are so many case-specific factors that influence sampling needs that detailed guidance of national scope is impractical. Some regions of the country have developed specific technical requirements and agency review/approvals of sampling and analysis plans. Regional guidance from local USEPA and USACE offices should be sought for developing project-specific sampling plans.

2.18 Cultural Resources and Munitions and Explosives of Concern. Two aspects of site characterization not covered in the preceding paragraphs can also significantly impact a dredging project—cultural resources and munitions and explosives of concern (MEC).

2.18.1 Cultural resources. A survey may be required for Environmental Impact Statements (EISs) to determine if any cultural resources may be impacted by the dredging operation. Cultural resources may include a wide range of items (prehistoric, historic, and maritime resources), but maritime resources (shipwrecks) are usually the most common type that may be impacted by dredging.

2.18.1.1 Waterborne magnetics (magnetometers). Magnetometers have a reasonable history of use in locating underwater shipwrecks. Waterborne magnetics is a passive system in which the measured disturbance of the ferrous metal target is a result of its interaction with the magnetic field of the earth. The magnetometer is a sensitive instrument used to map spatial variations in the magnetic field of the earth. In the proton magnetometer, a magnetic field not parallel to the

field of the earth is applied to a fluid rich in protons causing them to partly align with this artificial field. When the controlled field is removed, the protons precess toward realignment with the field of the earth at a frequency that depends on the intensity of that of the earth. By measuring this precession frequency, the total intensity of the field can be determined.

2.18.1.2 To conduct a magnetic survey, a hydrodynamically shaped body that houses the magnetometer, which senses anomalies in the magnetic field of the earth as it passes in the proximity of relatively large ferrous objects (for example, cannons and metal hulls), is usually towed behind a survey vessel. The incorporation of computers and nonvolatile memory in magnetometers has greatly increased their ease of use and data handling capability. The instruments typically keep track of position, prompt for inputs, and internally store the data for an entire day of work. Downloading the information to a personal computer is straightforward, and plots of the day's work can be prepared each night. EM 1110-1-1802 presents guidance concerning conventional magnetometer use.

2.18.1.3 Side-scan sonar. Side-scan sonars may also be used to conduct underwater surveys of cultural resources. They use acoustic energy projected laterally from a pair of transducers housed in a towed "fish." The received signal is transmitted through the tow cable to the shipboard recorder, which processes the signal and prints the record. The resulting image of the bottom is roughly similar to a continuous, oblique aerial photograph. However, the physics of underwater acoustics are sufficiently different from optics in the atmosphere that interpretation of side-scan sonar records requires training and experience. Side-scan sonars usually operate at one of two frequencies, around 100 or 500 kHz. The lower frequency has greater range but provides less detail than the higher frequency. These systems are used in commercial applications such as wreckage/lost-object searches (for example, ships, aircraft, mines, and torpedoes), seabed geological surveys, pipeline tracking, and biological surveying. EM 1110-2-1003 provides detailed information concerning side-scan sonar use for object detection.

## 2.18.2 Munitions and Explosives of Concern (MEC)

2.18.2.1 Various navigation and beach nourishment dredging projects have been impacted by the presence of MEC in the dredging and dredged material placement area (Welp et al. 1994; Welp, Pilon, and Bocamazo 1998; Welp, Clausner, and Pilon 1998).

2.18.2.2 Under the Environmental Security Technology and Certification Program (ESTCP), the Dredging Operations and Environment Research (DOER) program and the U.S. Navy prepared a document to provide guidance to personnel (such as planners, cost estimators, specification writers, engineers, managers, and dredging contractors) involved in dredging projects with sediment contaminated by the presence of Munitions and Explosives of Concern (MEC) (Welp et al. 2008). Unexploded Ordnance (UXO) is a military munitions definition under the more general classification of MEC. This guidance document is available on the Dredging Operations and Technical Support (DOTS) Program website (<http://el.erdc.usace.army.mil/dots/dots.html>).

### Section III

#### Dredging Equipment and Techniques

2.19 Purpose. This section describes the dredging equipment and techniques used in dredging activities in the United States and presents advantages and limitations for each type of dredge. Guidance is provided for selection of the best dredging equipment and techniques for a proposed dredging project to aid in planning and design.

2.20 Factors Determining Equipment Selection. The following factors influence the selection of dredging equipment and method(s) used to perform the dredging:

- a. Physical characteristics of the material to be dredged.
- b. Quantities and physical layout of the material to be dredged.
- c. Dredging depth.
- d. Location of both the dredging and placement sites and the distance between them.
- e. Physical environment of and between the dredging and placement areas.
- f. Contamination level of the sediments.
- g. Method of placement.
- h. Production required.
- i. Type of dredges available.

#### 2.21 Dredge Types.

2.21.1 The mechanisms used in the various stages of a navigation dredging operation are a function of the type of equipment used and the characteristics of the sediment being dredged. Each of these stages is accomplished using one or a combination of hydraulic and mechanical devices. Depending on the project, these stages may be modified by additional actions (for example, blasting rock before excavation). Final placement may include manipulation of the sediment by shaping or even drying and compacting it.

2.21.2 Dredges used in USACE navigation projects are usually classified by either the hydraulic or mechanical manner in which they achieve excavation and removal. Hydraulic and mechanical dredges have enabled the transformation of rivers and harbors throughout the world into navigable waterways, allowing the transport of commerce and people where water passage was historically unavailable. The hydraulic dredge has been a major contributor to this transformation by providing for the movement of large quantities of dredged material in relatively short time periods.



### 2.21.2.1 Hydraulic dredges.

a. Hydraulic dredges are characterized by the use of a centrifugal pump to dredge sediment and transport it, in a liquid slurry form, to a discharge area. The centrifugal pump was first developed in France in the early 1800s and then adapted to dredging in the 1850s by the USACE. In their present form, hopper and cutterhead pipeline dredges have been in existence since the 1870s and are now common throughout the world. Herbich (2000) and Turner (1996) provide detailed information on the principals of hydraulic dredging.

b. The major types of hydraulic dredges are hopper dredges and cutterhead pipeline dredges. Less common hydraulic types include dustpan and sidecaster dredges. In addition, special-purpose dredging systems have been developed during the last few years in the United States and overseas to pump dredged material slurry with high solids content and/or to minimize the resuspension of sediments. Most of these systems are not intended for use on typical navigation dredging projects; however, they provide alternative methods for unusual dredging projects, such as treatment of contaminated sediments. The term “environmental dredging” generally refers to remediation or cleanup projects where removal of contaminated sediment from the waterway to enhance environmental quality is the primary objective of the project. For more information on environmental dredging equipment, refer to paragraph 2.32.

c. Hopper, pipeline, and sidecaster dredges are named for the method they use to transport dredged material from the dredging site to the placement area. Dustpan dredges are named for their unique suction head configuration.

(1) Trailing suction (hydraulic) hopper dredges. Hopper dredges are seagoing vessels that excavate material hydraulically and transport it to a placement site in a hopper built into the hull of the vessel.

(2) Hydraulic pipeline dredges. Pipeline dredges are normally non-self-propelled dredges that may employ a mechanical cutter to break up the material, which is then excavated hydraulically and transported to the placement site through a pipeline.

(3) Hydraulic pipeline dustpan dredges. Dustpan dredges excavate material hydraulically with a unique, water jet-assisted suction head and transport it to an “in-water” placement site through a relatively short floating pipeline.

(4) Sidecaster or boom dredges. Sidecaster dredges are essentially hopper dredges without the hoppers. They excavate the material hydraulically and transport it to an “in-water” placement site adjacent to the dredged channel through a short pipe.

2.21.2.2 Mechanical dredges. Mechanical dredges are characterized by the use of some form of bucket to excavate and raise the bottom material. They are not normally assigned to transport the material to the ultimate placement area. In some cases the dredged material can be deposited directly in the water or on the bank immediately adjacent to the dredging area. Normally, however, the mechanical dredge deposits material into a barge that transports it to the placement site. Mechanical dredges may be classified into two subgroups by how their buckets

are connected to the dredge: wire rope-connected (clamshell or dragline) and structurally connected (a backhoe).

2.21.3 Estimated average cubic yardage dredged annually for Fiscal Years 2008-2012 by USACE Districts with contracted (non-Government) dredge plants and Government plants is broken down by dredge type and presented in Figure 2-22. The “Combinations or Other” category in this figure includes projects that used a combination of all, or any, of the dredges previously described. The percentage of the total average annual yardage (212 million cubic yards) dredged by type of dredge is illustrated in Figure 2-23.

2.21.4 The statistics in Figures 2-22 and 2-23 are based on data from the USACE Navigation Data Center (NDC), whose goal is to provide reliable information to support dredging and navigation project management decisions. Individual databases are maintained and operated that contain information on dredging, waterborne commerce, vessel statistics, lock operations, and port and lock facilities. The dredging database tracks all contracted and USACE-performed dredging from pre-bid through completion. Information in the database includes location of the dredging and placement sites, dredged quantity, type of dredge, type of placement, dates of bid advertisement, bid opening and contract award, units of contract measurement, small-business set-aside restrictions, Government cost estimate, all bids, winning bidder, business status of bidders, and actual cost and quantity dredged. The NDC website is located at <http://www.ndc.iwr.usace.army.mil/dredge/dredge.htm>.

## 2.22 Hydraulic Pipeline Cutterhead Dredges.

2.22.1 General. The hydraulic pipeline cutterhead dredge, or cutterhead dredge (Figure 2-24), is the most commonly used dredging vessel and is generally the most efficient and versatile. It performs the major portion of the dredging workload in the USACE dredging program. Because it is equipped with a rotating cutter apparatus surrounding the intake end of the suction pipe, it can efficiently dig and pump all types of alluvial materials and compacted deposits. This dredge has the capability of pumping dredged material long distances to upland placement areas. Slurries of 10-20% solids (by dry weight) are typical, depending upon the material being dredged, dredging depth, horsepower of dredge pumps, and pumping distance to the placement area. If no other data are available, a pipeline discharge concentration of 13% by dry weight should be used for preliminary design purposes. Pipeline discharge velocity, under routine working conditions, ranges from 15 to 20 ft/sec (4.5 to 6 m/s). Table 2-8 presents theoretical pipeline discharge rates as functions of pipeline discharge velocities for dredges ranging in sizes from 8 to 30 in (203 to 762 mm). Herbich (2000), Turner (1996), Huston (1986), and Bray, Bates, and Land (1997) provide more detailed information on hydraulic dredging principles, equipment, and operating methods.

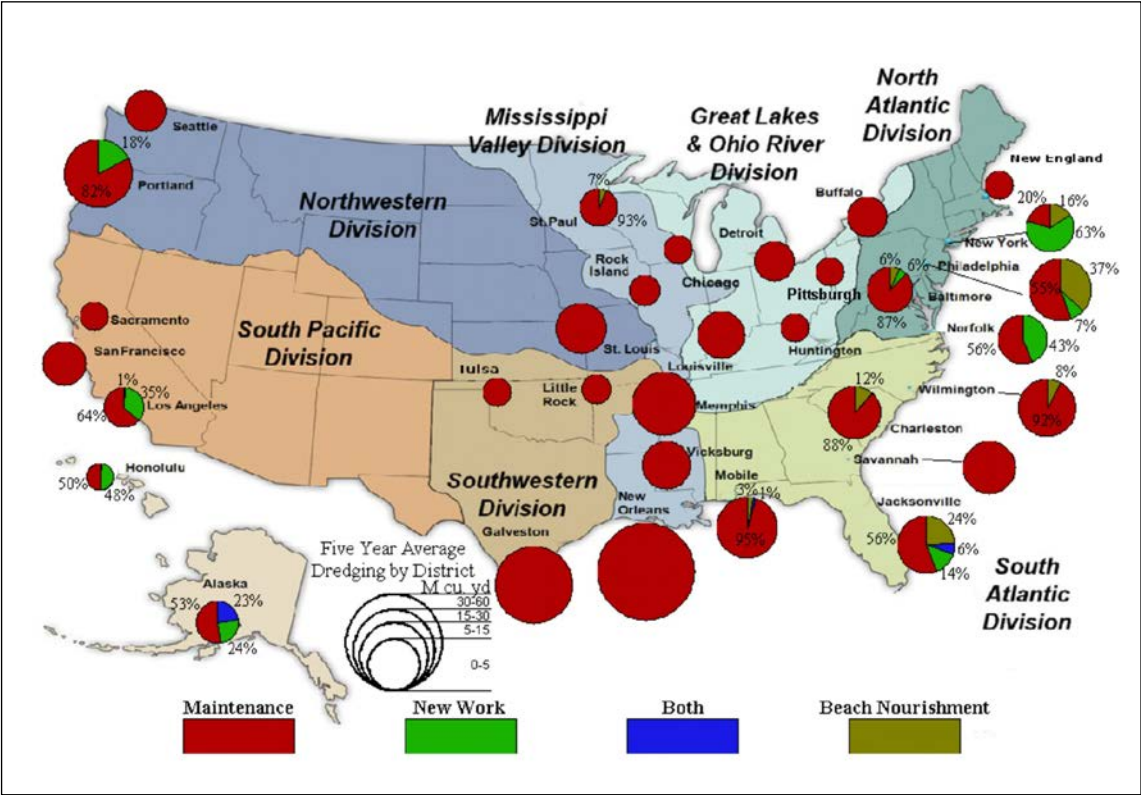

Figure 2-22. Percentage of Work Completed by Dredge Type with Respective Yardages for USACE Districts (Includes both Contractor and USACE Plant, Dredging an Average Annual Volume [FY 2008-2012] of 212 Million yd<sup>3</sup>/yr)

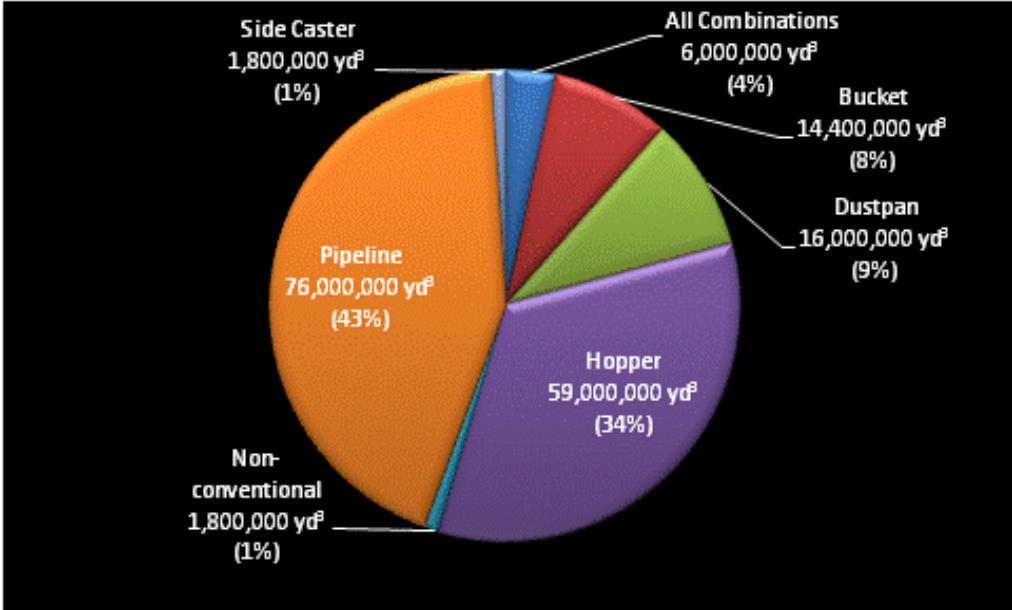

Figure 2-23. Percentage of Work Conducted by Dredge Type of an Average Annual Yardage (FY 2008-2012) of 212 Million yd<sup>3</sup>/yr (Includes both USACE and Contractor Plant)

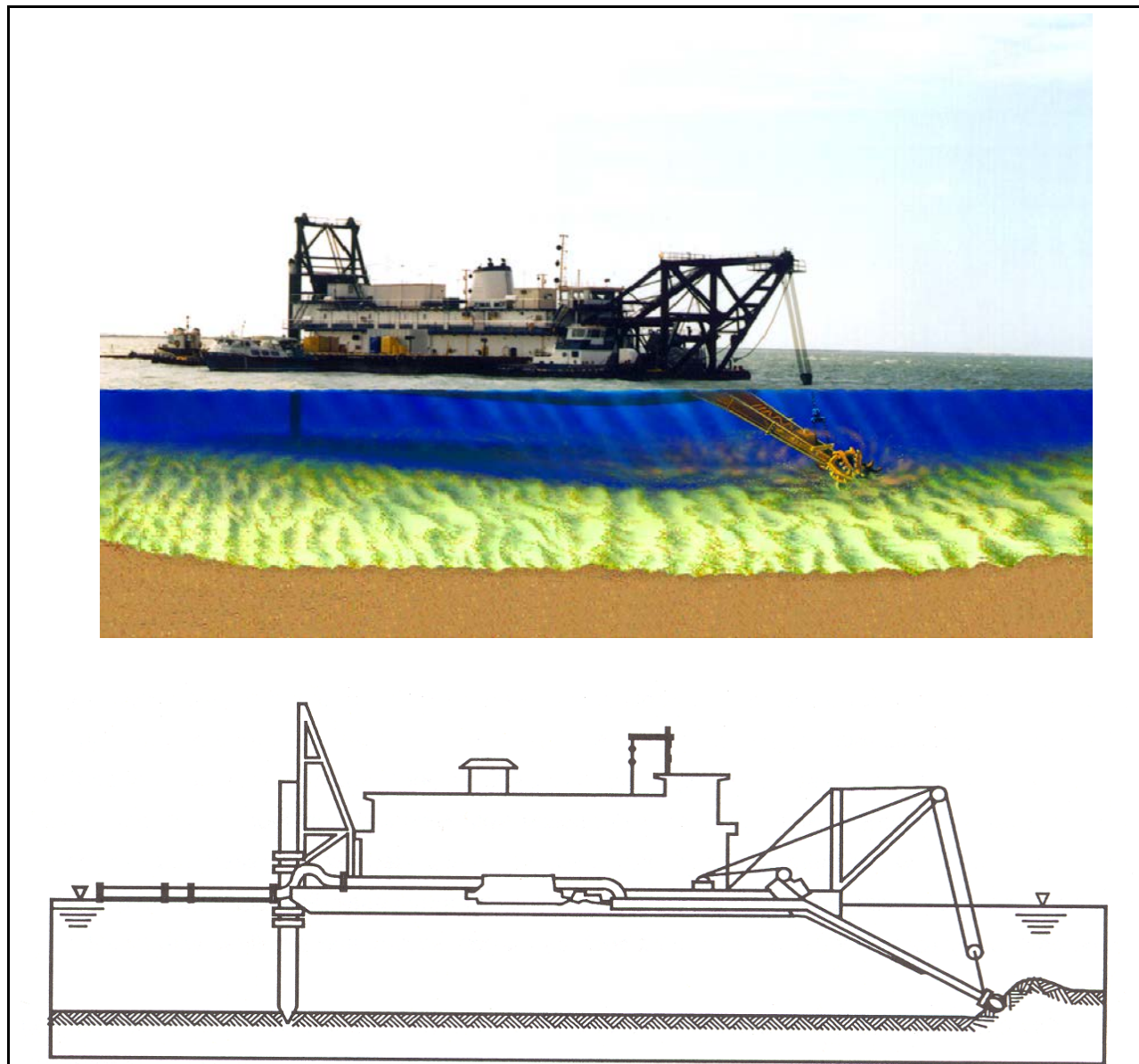

Figure 2-24. Hydraulic Pipeline Cutterhead Dredge

Table 2-8. Hydraulic Pipeline Dredge Discharge Rates

Discharge Velocity m/sec (ft/sec)	Discharge Pipe Diameter			
	8 in. (203 mm)	18 in. (457 mm)	24 in. (610 mm)	30 in. (762 mm)
3 (10)	0.13 (0.1) (1,575)	0.65 (0.5) (7,877)	1.16 (0.9) (14,100)	1.82 (01.4) (22,056)
4.5 (15)	0.19 (0.15) (2,303)	0.98 (0.75) (11,876)	1.75 (1.33) (21,207)	2.73 (2.09) (33,083)
6 (20)	0.26 (0.2) (3,150)	1.31 (1.0) (15,875)	2.33 (1.78) (28,236)	3.64 (2.78) (44,111)
7.6 (25)	0.32 (0.24) (3,878)	1.64 (1.25) (19,874)	2.91 (2.23) (35,265)	4.54 (3.47) (55,018)

Note: Discharge rate = pipeline area × discharge velocity.

2.22.2 Production rate. Production rate is usually defined as the number of cubic yards of in situ sediments dredged during a given period (commonly expressed in  $\text{yd}^3/\text{hr}$ ). Cutterhead dredge productivity is dependant primarily on the dredge pumping capacity, depth of cut, advance rate, height of bank to be cut, cutter size, geometry, horsepower, speed, ladder swing rate and direction, width of cut, operator efficiency, dredge efficiency, and sediment characteristics. Parameters that influence pumping capacity include pump horsepower, diameter, and condition and pipeline configuration (line length and geometry, type of pipeline, vertical lift, and the presence of ladder and/or booster pumps). Booster pumps are used when the pipeline length exceeds the power capability of the dredge pump or a higher production rate is desired. Other site conditions that can have a very significant effect on production include weather, waves, currents, tides, vessel traffic, and presence of debris and contaminants (including UXO). Figure 2-25 (from Palermo, Montgomery, and Poindexter 1978) shows the relationship among solids output, dredge size, and pipeline length for various dredging depths. Information concerning the estimation of dredge production is presented in paragraph 2.29.2.

### 2.22.3 Description of operation.

2.22.3.1 The cutterhead dredge is generally equipped with two stern spuds used to hold the dredge in working position and to advance the dredge into the cut or excavating area. During operation, the cutterhead dredge swings from side to side alternately using the port and starboard spuds as a pivot, as shown in Figure 2-26. Cables attached to swing anchors on each side of the dredge control lateral movement. Swing anchors are set out and repositioned by anchor-handling derrick barges or, in areas where water depth precludes derrick barge passage, anchor booms (fastened to the dredge hull) have been used to set the anchors. The dredge forward movement, or advance, is achieved by lowering the starboard spud (now called the working spud) after the port swing is made and then raising the port spud (now called the walking spud). The dredge is then swung back to the starboard side of the cut center line. The port spud is lowered and the starboard spud lifted to advance the dredge. This double-spud configuration is the most commonly used way to advance a cutterhead, but a limited number of dredges use a spud carriage, which basically consists of a working spud mounted in a hydraulic ram-driven carriage that translates in a longitudinal (parallel to the dredge center line) slot. A spud carriage can advance the dredge more quickly than a double-spud configuration, achieving higher production.

2.22.3.2 The excavated material may be placed in areas such as open water sites, on a beach, or in confined placement areas located either in the water or upland. In the case of open-water placement, a floating discharge pipeline may be used. The floating discharge pipeline can consist of sections of pipe mounted on pontoons and held in place by anchors, or it may consist of flexible floating hose (for example, rubber hose encased in buoyant material). Submerged discharge pipeline (either steel or high-density polyethylene [HDPE]) can, under appropriate site-specific conditions, be used to reduce wave- and current-induced forces to enhance pipeline joint connectivity. Additional sections of shore pipeline are required when upland placement is used. In addition, the excavated materials may be placed in hopper barges for subsequent placement in open water or in confined areas that are remote from the dredging area. Slurry is transferred into barges using "spider" barges. A spider barge (shown in Figure 2-27 without transportation barges alongside) is named for its spiderlike shape upon the water. It is attached to

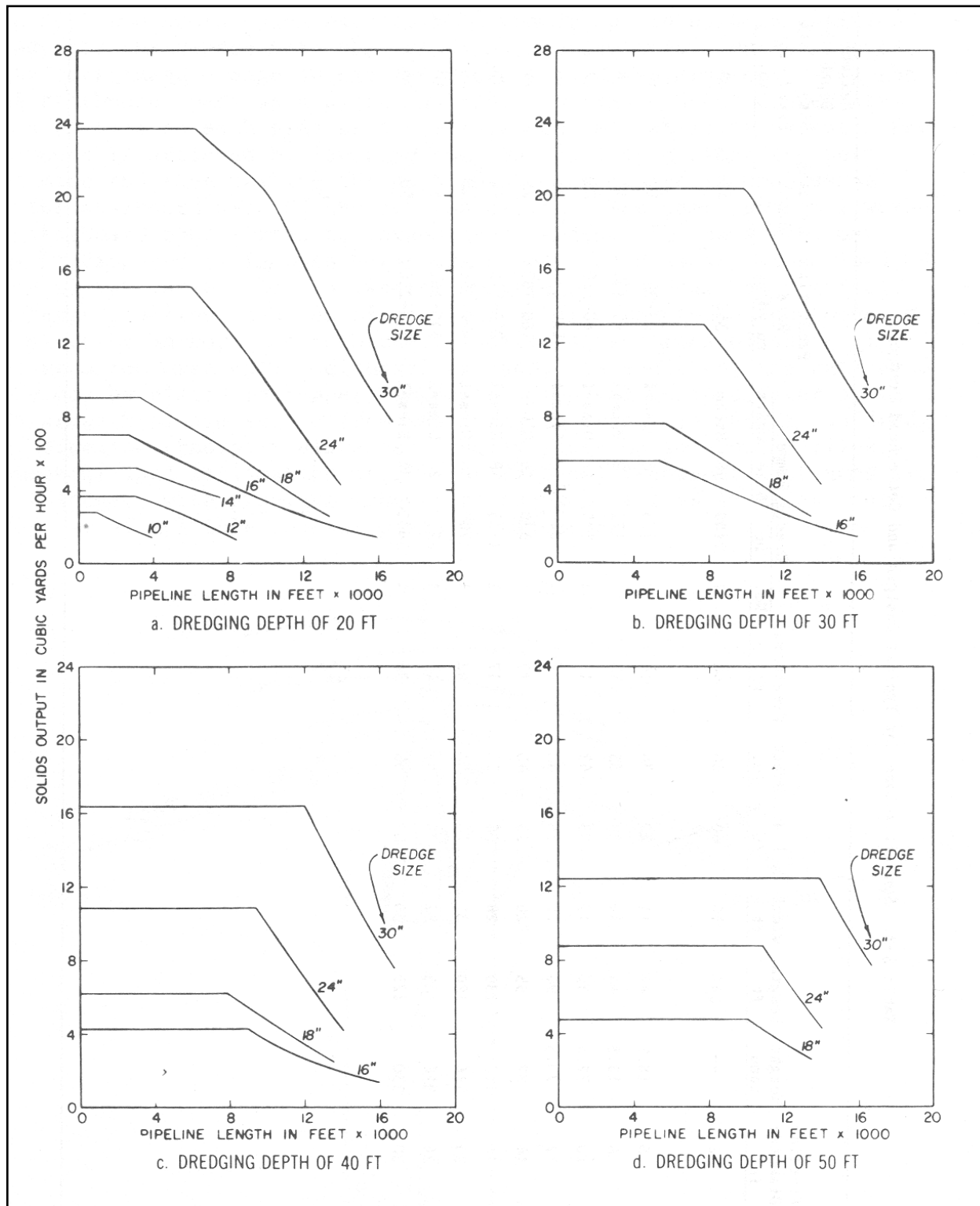

Figure 2-25. Relationships Among Solids Output, Dredge Size, and Pipeline Lengths for Various Dredging Depths (from Palermo, Montgomery, and Poindexter 1978)



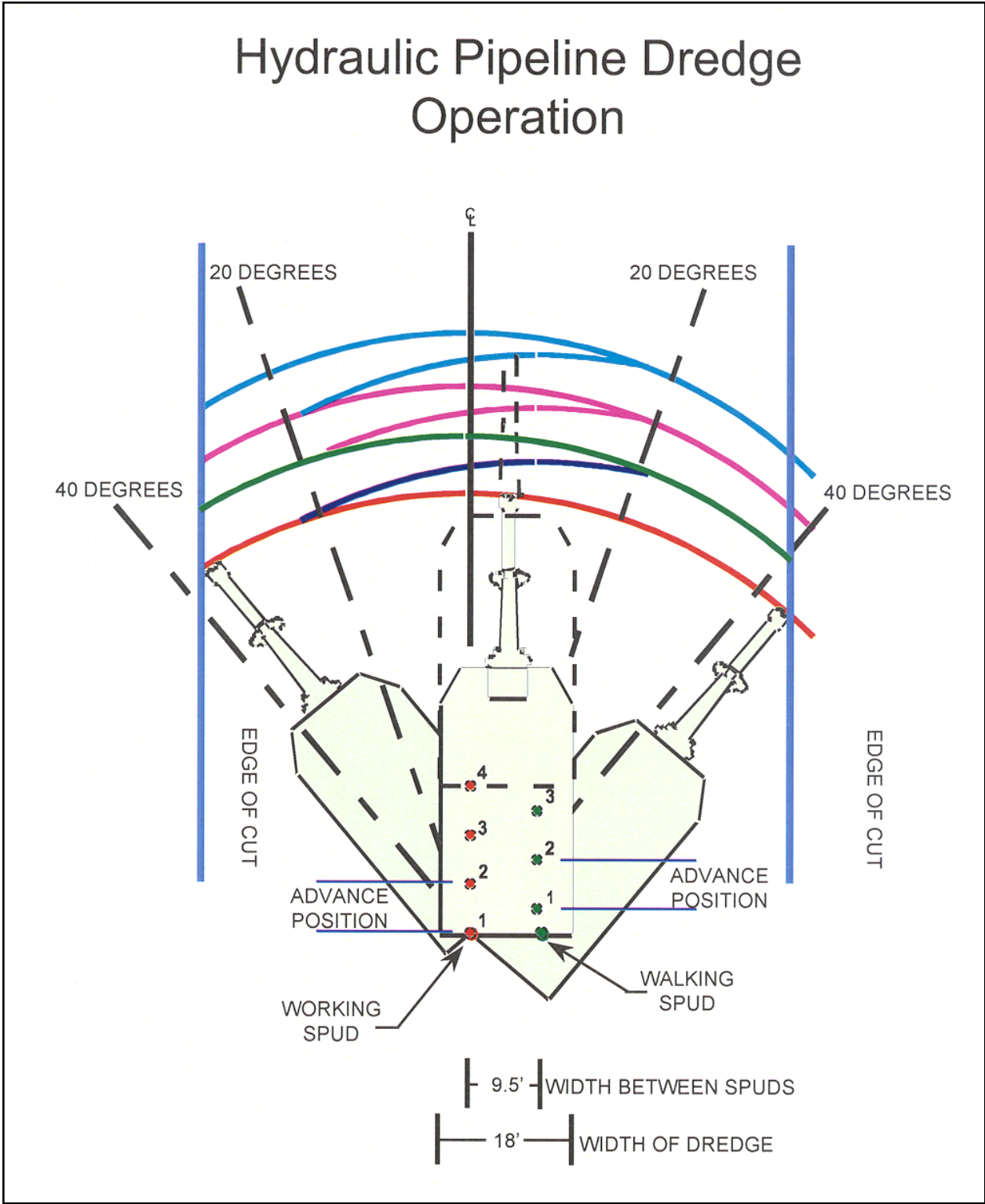

Figure 2-26. Operation of a Cutterhead Dredge



Figure 2-27. Spider Barge Connected to a Hydraulic Pipeline Dredge

the dredge discharge pipeline and is usually designed to reduce slurry flow turbulence by diffusing, thus enhancing solids settlement in the transportation barge. The use of multiple discharge points allows the cutterhead dredge to be operated in a more continuous manner due to the capability of the spider barge to have more than one transportation barge tied up alongside.

2.22.3.3 In cutterhead dredging, the pipeline transport distances usually range up to about 3 miles (5 m). For commercial land reclamation or fill operations, transport distances are generally longer, with pipeline lengths reaching as far as 22 miles (35 km), for which the use of multiple booster pumps is necessary.

2.22.4 Application. Although the cutterhead dredge was developed to loosen up densely packed deposits and eventually cut through soft rock, it can excavate a wide range of materials, including clay, silt, sand, and gravel. The cutterhead dredge is suitable for maintaining harbors, canals, and outlet channels where wave heights are not excessive. A cutterhead dredge designed to operate in calm water does not effectively operate offshore in waves over 2-3 ft (0.6-1 m) in height; the cutterhead is forced into the sediment by wave action creating excessive shock loads on the ladder.

2.22.5 Advantages. The cutterhead dredge is the most widely used dredge in the United States because of the following advantages:

a. Cutterhead dredges are used on both new work and maintenance projects and are capable of excavating most types of material and pumping it through pipelines for long distances to upland placement sites.



b. The cutterhead operates on an almost continuous dredging cycle, resulting in maximum economy and efficiency.

c. The larger and more powerful machines are able to dredge rocklike formations, such as coral and the softer types of basalt and limestone, without blasting.

2.22.6 Limitations. The limitations on cutterhead dredges are as follows:

a. The cutterhead dredges available in the United States have limited capability for working in open-water areas without endangering personnel and equipment. The dredging ladder on which the cutterhead and suction pipe are mounted is rigidly attached to the dredge; this causes operational problems in areas with high waves.

b. High sea states can break discharge pipelines, causing either possible damage to nearby structures resulting from runaway pontoons/pipe or navigation hazards resulting from sunken pontoons/pipe. High seas can also make the act of adding or removing discharge pipelines during high seas more dangerous to dredge personnel.

c. Depth outside the channel can limit the distance that the dredge can move out of the channel, depending on its draft. The dredge may have to break the discharge pipeline well in advance to afford the time for it to be satisfactorily out of the way.

d. The conventional cutterhead dredges are not self-propelled. They require the mobilization of large towboats in order to move between dredging locations.

e. Cutterhead dredges have problems removing medium and coarse sand when maintaining open channels in rivers with rapid currents. It is difficult to hold the dredge in position when working upstream against the river currents since the working spud often slips due to scouring effects. When the dredge works downstream, the material that is loosened by the cutterhead is not pulled into the suction intake of the cutterhead. This causes a sandroll, or berm, of sandy material to form ahead of the dredge.

f. The pipeline from the cutterhead dredge can cause navigation problems in small, busy waterways and harbors. The dredge itself can also be a hazard to navigation due to its immobility operating on spuds.

g. Additional information on excavation characteristics of this type of dredge is presented in Tavolaro et al. (2007).

## 2.23 Trailing Suction (Hydraulic) Hopper Dredges.

2.23.1 General. Trailing suction (hydraulic) hopper dredges, or hopper dredges, are self-propelled seagoing ships that, in the United States, vary in length from 180 to 510 ft (55 to 155 m), with the molded hulls and lines of ocean vessels (Figure 2-28). They were developed for

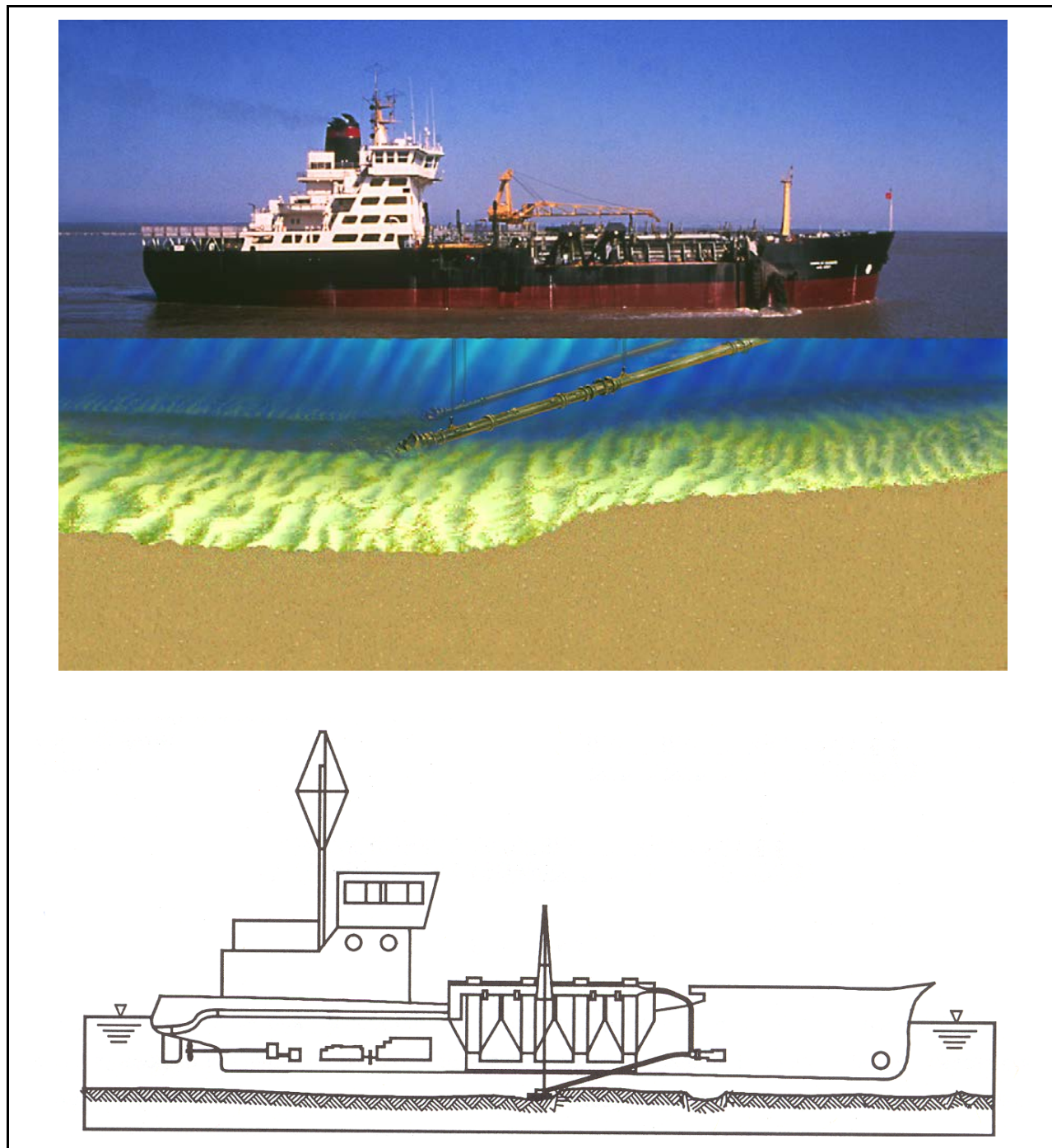

Figure 2-28. Hopper Dredge

maintenance work, the first being the *General Moultrie*, built in 1855 for work on the Charleston, SC, bar. Hopper dredges are equipped with propulsion machinery, sediment containers (hoppers), dredge pumps, and other special equipment required to perform their essential function of removing material from a channel bottom or ocean bed and placing that material in open water or upland sites. Hopper dredges have propulsion power adequate for required

free-running speed and dredging against strong currents as well as excellent maneuverability for safe and effective work in rough, open seas. The vessel hull is compartmented into one or more hoppers. The normal configuration has two drag arms, one on each side of the ship. A drag arm is a pipe suspended over the side of the vessel with a suction opening called a drag head. Single drag arms are common on smaller hopper dredges while a government hopper dredge, the *Wheeler*, has three drag arms (one on each side and one in the middle). The drag arm is connected to a dredge pump, usually located inside the hull through a flexible “through-hull” connection called a trunnion. In some cases the dredge pump is located on the drag arm to increase its hydraulic efficiency.

2.23.2 Capacity. The rated capacity of a hopper dredge is based on the volumetric capacity of its hoppers and not necessarily on the amount of material it can safely load. A hopper dredge is classified by the American Bureau of Shipping with a maximum load line that is based on the maximum weight of the material in its hoppers. A dredge rated capacity of 4,000 yd<sup>3</sup> (1,220 m<sup>3</sup>) could safely load 4,000 yd<sup>3</sup> (1,220 m<sup>3</sup>) of relatively light silt but not necessarily that volume of sand, which is much heavier.

#### 2.23.3 Description of operation.

2.23.3.1 During dredging operations, hopper dredges travel at a ground speed of 2-3 miles per hour (3-5 kilometers per hour) and can dredge in depths from approximately 10-140 ft (3-43 m). Some hopper dredges can work in maximum wave (swell) heights of about 12 ft (3.5 m), but at reduced production rates. They are usually equipped with twin propellers as well as twin rudders and bow thrusters to provide the required maneuverability.

2.23.3.2 Hopper dredges are equipped with high-volume, low-head dredge pumps, and dredging is accomplished by progressive traverses over the area to be dredged. In addition, they are able to maintain the velocities required to carry a high percentage of solids in the suction and discharge lines. The American practice is to use either diesel-engine- or electric-motor-driven pumps while European dredges use electric-motor-driven pumps almost exclusively. Most dredge pumps are located in the forward part of the dredge, positioned as low as possible in the vessel and adjacent to the inboard end of the trunnion elbow. This position allows the pump to operate under flooded suction conditions, which is critical to efficient high-volume, low-head pumping operations.

2.23.3.3 The drag head is moved along the channel bottom as the vessel moves forward at speeds up to 3 miles per hour (5 kilometers per hour). The dredged material is entrained into the drag head, moves up the drag pipe, and deposited and stored in the hoppers of the vessel. The drag head is a steel structure designed to fit on the end of the drag pipe and present a flat or shaped surface to the bottom material. There are suction openings in the bottom as well as steel members for bracing or cutting. The drag head controls the material entrance conditions, which are extremely important to the hydraulic efficiency of the dredge. Four types of drag heads are common.

a. The erosional drag head. This type is designed with slots around the perimeter of the surface in contact with the bottom. In operation, high fluid velocities are created in these slots, which erode the bottom material and suspend it in the slurry, which in turn is driven up the

suction tube. High perimeter-to-area ratios are characteristic of this type, and it is most effective in sand and gravel type materials. The California, Eastern, and articulated visor style drag heads work on the erosional principle.

b. Straight suction drag head. This type is designed to seal the perimeter of the contact surface to the bottom. In operation, water is excluded from the drag head, and the bottom material is driven up the suction tube at its in situ specific gravity. Low perimeter-to-area ratios are characteristic of these types, and they are most effective in silt and other low shear-strength materials. Fixed visor and box type drag heads work on the straight suction principle. Mechanical shear type drag heads are sometimes used for dredging silt also. They, too, are designed to exclude as much water as possible from the drag head in order to maximize the material density in the dragpipe. The Dutch roller type is an example of a mechanical shear type silt drag head.

c. "Water jet" drag head. This type is designed with high-velocity jets that fluidize the bottom material. They can also incorporate teeth that mechanically scrape up material into the drag head. Water jet drag heads are most efficient in hard-packed fine sand materials. Their advantages in coarse-grained materials are debatable in view of their added complexity and the cost of pumping the high-pressure water required to drive the jets. On the other end of the spectrum, they add too much water to be effective in dredging silt materials.

During the past few years, the USACE, along with private industry, has developed procedures and equipment to reduce dredging impacts to sea turtles. The use of these procedures and equipment has reduced the number of incidental intakes during a period of increasing dredging activity. Deflectors are designed to ensure efficient excavation of material and movement of sea turtles out of the path of the operating draghead.

2.23.3.4 Drag heads are designed to handle the limited rotational motions induced by bottom irregularities. They are not, however, able to handle the much larger rotational and translational motions induced by the dredge operating in the seaway. The latter must be handled by the drag arm. To do this, modern hopper dredges use a trunnion elbow to connect the drag arm to the hull. This fitting is designed to handle vertical rotational motion. In addition, a gimbal joint is installed near the center of the arm to handle the vertical and transverse translational motions. Finally, a turning gland is located at the drag head end of the arm to handle longitudinal rotation. Some dredges use ball joints instead of gimbals. However, ball joints are subject to leaking, which is undesirable, especially with their location on the suction side of the dredge pump.

2.23.3.5 It is important to note that drag arms are not designed for compression loads. Therefore, the dredge must never be backed down on the drag heads during the dredging operations. The drag arms are hung by wire ropes from davits located on the deck. The outboard ends of the drag and gimbal wires are connected to the drag arm at the drag head and gimbal joint, and the inboard ends are connected to winches that control the vertical position of the drag arm assembly. Most modern hopper dredges also have sliding trunnion elbows, which allow the entire drag arm assembly to be hoisted aboard the dredge. This feature greatly improves the docking of the dredge and the safety and efficiency of maintaining the drag arm components.

2.23.3.6 Hopper dredges use swell compensators on the drag wires to maintain, essentially, a constant pressure contact between the drag head and the bottom. The principle is relatively simple. By setting the hydraulic cylinder pressure so that it supports the desired amount of drag head weight, the system demands that the remainder of the drag head weight be supported by the bottom. This system enables the drag head to remain on the bottom when dredging in a seaway while at the same time controlling digging depth. Both are essential to effective hopper dredge operation.

2.23.3.7 Several American hopper dredges are equipped with submerged dredge pumps located on their drag arms. This arrangement allows the pump to operate at higher efficiencies due to the improved barometric head conditions. However, the improved efficiency is partially offset by the higher cost and the added weight and complexity to the drag arm structure.

2.23.3.8 Herbich (2000) and Bray, Bates, and Land (1997) provide more detailed information on hopper dredge equipment and operating methods. Another reference document, "The Hopper Dredge, Its Development and Operation" (USACE 1954) is dated, but it is still a good source for the fundamentals of hopper dredging.

2.23.3.9 Once loaded, hopper dredges move to the placement site to unload before resuming dredging. Split-hull hopper dredges are unloaded by splitting the hull open to allow the dredged material to fall to the open-water placement site (Figure 2-29). Some hopper dredges use water jets inside the hopper to shorten the unloading time. Several hopper dredges have doors in the hopper bottoms that open to gravity-dump material. Most dredges, either split-hull or bottom dump, are also equipped with pump-out systems to pump the dredged material to upland placement sites (for example, beach nourishment projects).

2.23.3.10 Hopper dredge loading is accomplished by one of three methods: pumping past overflow, agitation dredging, and pumping to overflow. The use of these methods is controlled to varying degrees by environmental legislation and the water quality certification permits required by the various states in which the dredging is being accomplished. The environmental effects of these methods must be assessed on a project-by-project basis. If the material being dredged is clean sand, the percentage of solids in the overflow will be small, and economic loading may be achieved by pumping past overflow. An economic load is defined as that hopper load, measured in cubic yards of dredged material equivalent in density to that in situ, dredged and hauled during a single dredging cycle, that will yield, for a particular dredge, the maximum rate of removal of material from the project area and that will result in a minimum unit cost per cubic yard hauled. The field procedure involved in conducting an economic load simply consists of periodically measuring the hopper load during the loading process and at the same time observing and recording the pumping and turning time attributable to these load measurements.



Figure 2-29. Split-Hull Hopper Dredge Unloading Dredged Material (Dredge *Sugar Island*, Great Lakes Dredge and Dock Company)

2.23.3.11 When contaminated sediments are to be dredged and/or adverse environmental effects have been identified, pumping past overflow is not recommended. In such cases, other types of dredges may be more suitable for removing the sediments from the dredging prism. If hopper dredges are not allowed to pump past overflow in sediments that have good settling properties, the cost of dredging increases. The settling properties of silt and clay sediments may be such that only a minimal load increase would be achieved by pumping past overflow. These determinations, along with environmental considerations, should be used to establish the operation procedures for the hopper dredge.

2.23.3.12 Hopper dredge production is best evaluated in terms of its cycle components: excavation time, transport time, and placement time.

a. Evacuation time. Excavation time per load may be limited to pumping to the point of overflow due to environmental concerns, or it may be continued beyond overflow to obtain an economic load. Factors that affect hopper dredge excavation rates are similar to those previously described for cutterhead dredges, but they differ with respect to the operating characteristics inherent with use of the drag head versus cutterhead suction opening.

b. Transport time. Transport time is affected by the vessel propulsion capacity, and it may also be affected by such factors as ship traffic, weather, sailing distance, currents, and tides.

c. Placement time. Placement consists of either gravity dumping or pumping out the material. The time required to gravity-dump the material in open water depends on the type of material dumped and the dredge. If the material is pumped out, the time becomes a function of

pump horsepower, pump size, discharge diameter, and pipeline length, similar to a pipeline dredge. The volume of dredged material per load depends on hopper size, dredge load carrying capacity, type and characteristics of material, and environmental concerns.

2.23.3.13 Agitation dredging is a process that intentionally discharges overboard large quantities of fine-grained dredged material by pumping past overflow, under the assumption that a major portion of the sediments passing through the weir overflow will be transported and permanently deposited outside the channel prism by tidal, river, or littoral currents. Agitation dredging should be used only when the sediments dredged have poor settling properties, when there are currents in the surrounding water to carry the sediments from the channel, and when the risk to environmental resources is low. Favorable conditions may exist at a particular project only at certain times of the day, such as at ebb tides, or only at such periods when the stream-flow is high. To use agitation dredging effectively requires extensive studies of the project conditions and definitive environmental assessments of the effects (Palermo and Randall 1990). Agitation dredging should not be performed in slack water or when prevailing currents permit redeposit of substantial quantities of the dredged material in the project area or in any other area where future excavation may be required. Refer to paragraph 2.30 for more information on this topic.

2.23.4 Application. Hopper dredges are used mainly for maintenance dredging in exposed harbors and shipping channels where traffic and operating conditions rule out the use of stationary dredges. The materials excavated by hopper dredges cover a wide range of types, but hopper dredges are most effective in the removal of material that forms shoals after the initial dredging is completed. While specifically designed drags are available for use in raking and breaking up hard or consolidated materials, hopper dredges are most efficient in excavating loose, unconsolidated materials. At times, hopper dredges must operate under hazardous conditions caused by fog, rough seas, and heavy traffic encountered in congested harbors. Hopper dredges and bucket dredges can be equally economical at a given distance and environmental conditions; however, the greater the distance, the more economical the bucket dredge becomes and vice versa for shorter distances where cutterheads cannot work for whatever reasons.

2.23.5 Advantages. Because of the hopper dredge design and method of operation, the self-propelled seagoing hopper dredge has the following advantages over other types of dredges for many types of projects:

- a. It is the only type of dredge that can work effectively, safely, and economically in rough, open water.
- b. It can move quickly and economically to the dredging project under its own power.
- c. Its operation causes minimal interference with and obstructions to passing traffic.
- d. Its method of operation produces usable channel improvement almost as soon as work begins. A hopper dredge usually traverses the entire length of the problem shoal, excavating a shallow cut during each passage and increasing channel depth as work progresses.
- e. The hopper dredge may be the most economical type of dredge to use where placement areas are not available within economic pumping distances of the hydraulic pipeline dredge.

2.23.6 Limitations. The hopper dredge is a seagoing self-propelled vessel designed for specific dredging projects. The following limitations are associated with this dredge:

- a. Its deep draft precludes use in shallow waters, including barge channels.
- b. It cannot dredge continuously. The normal operation involves loading, transporting material to the dump site, unloading, and returning to the dredging site.
- c. The hopper dredge excavates with less precision than other types of dredges.
- d. Its economy of operation is reduced when pumping past overflow is prohibited and low-density material must be transported to the placement site.
- e. It has difficulty dredging side banks of hard-packed sand.
- f. The hopper dredge cannot dredge effectively around piers and other structures.
- g. Consolidated and cohesive clay material cannot be economically dredged with the hopper dredge.
- h. Additional information on excavation characteristics of this type of dredge is presented in Tavolaro et al. (2007).

## 2.24 Hydraulic Pipeline Dustpan Dredges.

2.24.1 General. The dustpan dredge is a self-propelled hydraulic pipeline dredge that uses a widely flared dredging head along which are mounted pressure water jets (Figure 2-30). The jets loosen and agitate the sediments, which are then captured in the dustpan head as the dredge itself is winched forward into the excavation. This type of dredge was developed by USACE to maintain navigation channels in uncontrolled rivers with bed loads consisting primarily of sand and gravel. The first dustpan dredge, the *Alpha*, was developed in the 1890s by the USACE Mississippi River Commission to maintain navigation on the Mississippi River during low river stages. A dredge was needed that could operate in shallow water but was still large enough to excavate the navigation channel in a reasonably short time. The dustpan dredge operates with a low-head, high-capacity centrifugal pump since the material has to be raised only a few feet above the water surface and pumped a short distance. The dredged material is normally discharged into open water adjacent to the navigation channel through a pipeline usually only 800-1,200 ft (250 -365 m) long. Factors that affect dustpan dredge production rates are similar to those previously described for cutterhead dredges, but they differ with respect to the operating characteristics inherent with use of a dustpan versus a cutterhead.

2.24.2 Description of operation. The dustpan dredge maintains navigation channels by making a series of parallel cuts through the shoal areas until the authorized widths and depths are achieved. Typical operation procedures for the dustpan dredge are as follows:

- a. The dredge moves to a point about 500 ft (150 m) upstream of the upper limit of the dredging area, and the hauling anchors are set. Two anchors are used, as shown in Figure 2-31.



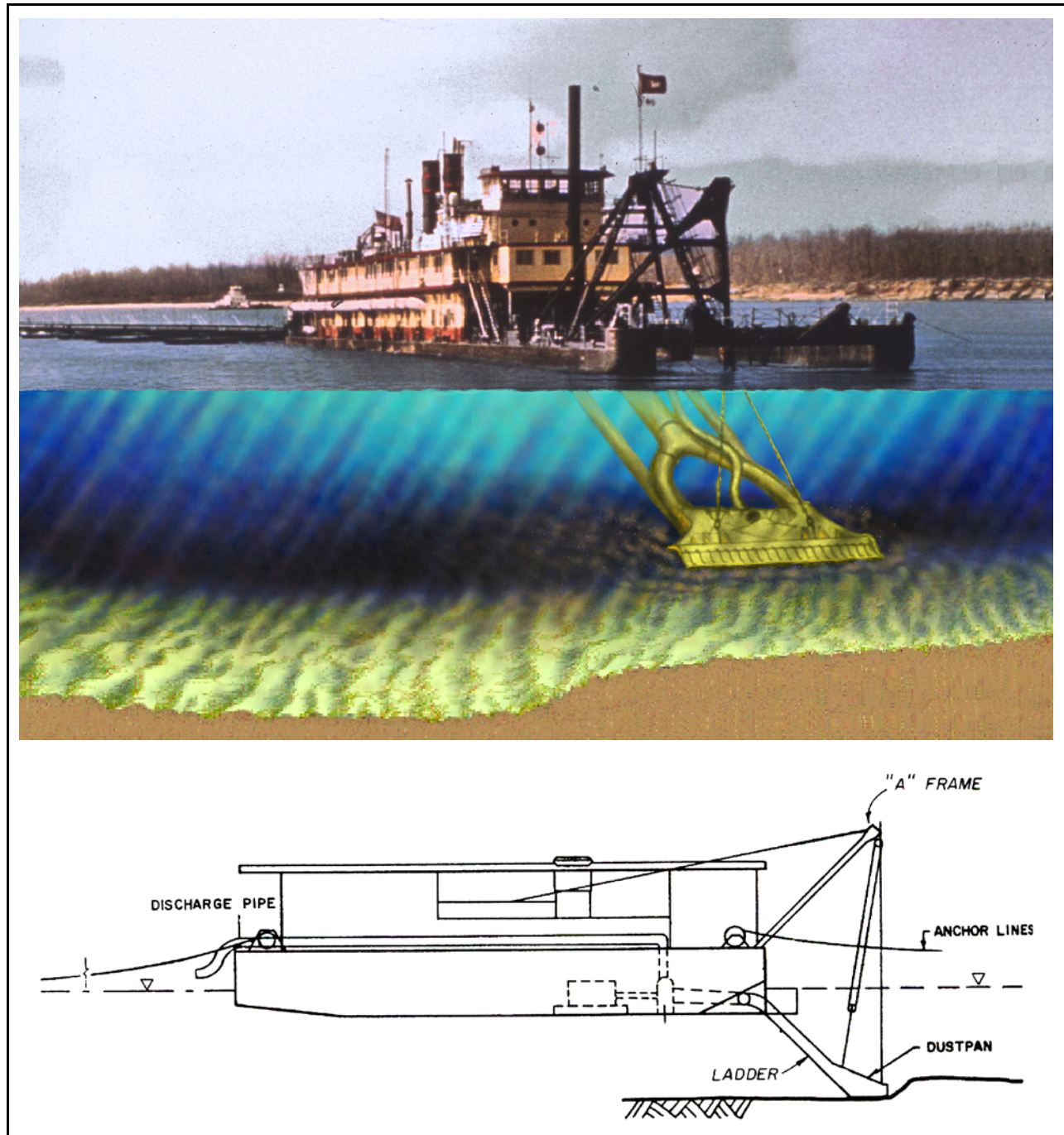

Figure 2-30. Dustpan Dredge

The hauling winch cables attached to the anchors are crossed to provide better maneuverability and control of the vessel during operation.

b. The dredge is then moved downstream to the desired location. The dustpan is lowered to the required depth, the dredge pump and water jet pumps are turned on, and the dredging commences. The dredge is moved forward by the hauling cables. The rate of movement depends

31 Jul 15

on the materials and the height of the cut face being dredged, the depth of dredging, currents, and the wind. In shallow cuts, the advance may be as rapid as 800 ft/hr (245 m/hr).

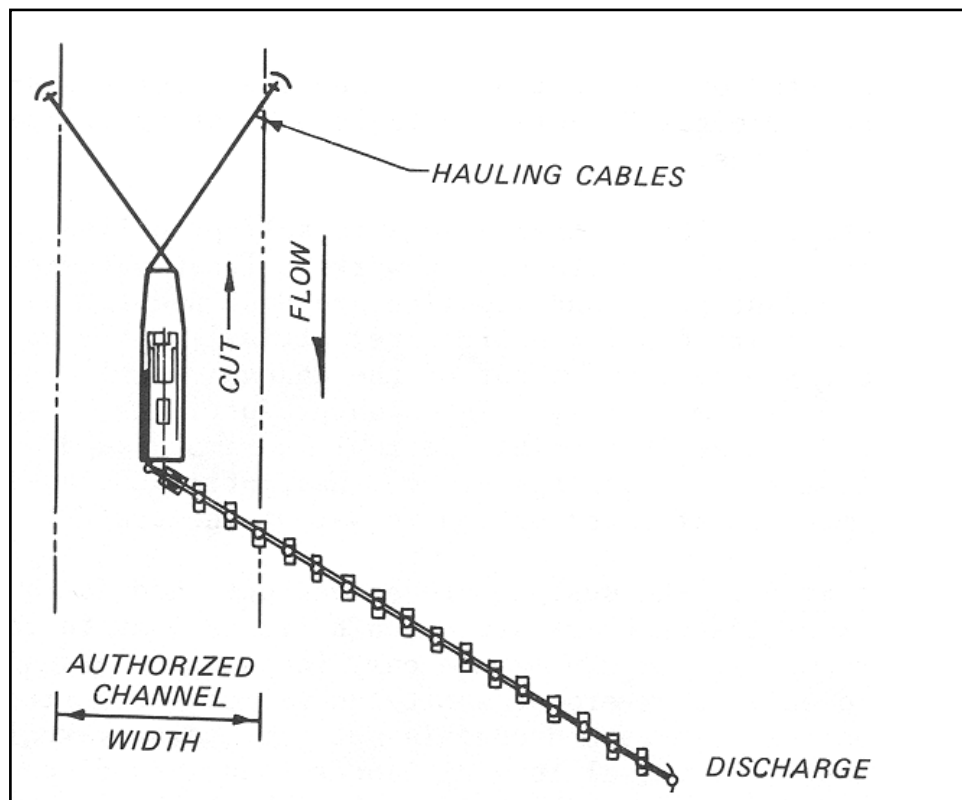

Figure 2-31. Dustpan Dredge Operating Configuration

c. When the upstream end of the cut is reached, the suction head is raised, and the dredge is moved back downstream to make a parallel cut. This operation is repeated until the desired dredging widths and depths are achieved.

d. The suction head may have to be lowered or raised if obstacles such as boulders, logs, or tree stumps are encountered. Experience with dustpan dredges indicates that the best results are obtained when the height of the cut face does not exceed 3 m (10 ft) in depth.

e. The dredge is moved outside the channel to let waterborne traffic pass through the area simply by raising the suction head and slacking off on one of the hauling winch cables. The propelling engines can be used to assist in maneuvering the dredge clear of the channel. The vessel is held in position by lowering either the suction head or a spud.

2.24.3 Application. The pipeline system and the rigid ladder used with the dustpan dredge make it effective only in rivers or sheltered waters; it cannot be used in estuaries or bays where significant wave action occurs. Because it has no cutterhead to loosen hard, compact materials, the dustpan dredge is suited mostly for high-volume, loose-material dredging. Dustpan dredges are used primarily to maintain the navigation channel of the uncontrolled open reaches of the Mississippi River, but they have been used occasionally on the Missouri and Ohio Rivers.

2.24.4 Advantages. The dustpan dredge is self-propelled, which enables it to move rapidly over long distances to work at locations where emergencies occur. The attendant plant and pipeline are designed for quick assembly so that work can be started a few hours after arrival at the work site. The dustpan dredge can move rapidly out of the channel to allow traffic to pass and can resume work immediately. The high production rate and design of the dustpan dredge make it possible to remove sandbar formations and deposits from river crossings rapidly so that navigation channels can be maintained with a minimum of interruption to waterborne traffic.

2.24.5 Limitations. The dustpan dredge was designed for a specific purpose, and for this reason there are certain limitations to its use in other dredging environments. It can dredge only loose materials such as sands and gravels and only in rivers or sheltered waters where little wave action may be expected, unless it is specially designed and built for more open water operation (for example, the dredge *Beachbuilder*). Conventional dustpan dredges are configured to transport material only a relatively short distance compared to a cutterhead dredge.

## 2.25 Sidecasting Dredges.

2.25.1 General. The sidecasting type of dredge (Figure 2-32) is a shallow-draft seagoing vessel, specially designed to remove material from the bar channels of small coastal inlets. The hull design is similar to that of a hopper dredge; however, sidecasting dredges do not usually have hopper bins. Instead of collecting the material in hoppers onboard the vessel, the sidecasting dredge pumps the dredged material directly overboard through an elevated discharge boom; thus, its shallow draft is unchanged as it constructs or maintains a channel. The discharge pipeline is suspended over the side of the hull by structural means and may be supported by either a crane or a truss and counterweight design. The dredging operations are controlled by steering the vessel on predetermined ranges through the project alignment. The vessel is self-sustaining and can perform work in remote locations with a minimum of delay and service requirements. The projects to which the sidecasters are assigned are, for the most part, at unstabilized, small inlets that serve the fishing and small-boat industries. Dangerous and unpredictable conditions prevail in these shallow inlets, making it difficult for conventional plant to operate except under rare ideal circumstances.

2.25.2 Description of operation. The sidecasting dredge picks up the bottom material through two drag arms and pumps it through a discharge pipe supported by a discharge boom. During the dredging process, the vessel travels along the entire length of the shoaled area, casting material away from and beyond the channel prism. Dredged material may be carried away from the channel section by littoral and tidal currents. The construction of a deepened section through the inlet usually results in some natural scouring and deepening of the channel section since currents moving through the prism tend to concentrate the scouring action in a smaller active zone. A typical sequence of events in a sidecasting operation is as follows:

- a. The dredge moves to the work site.
- b. The drag arms are lowered to the desired depth.

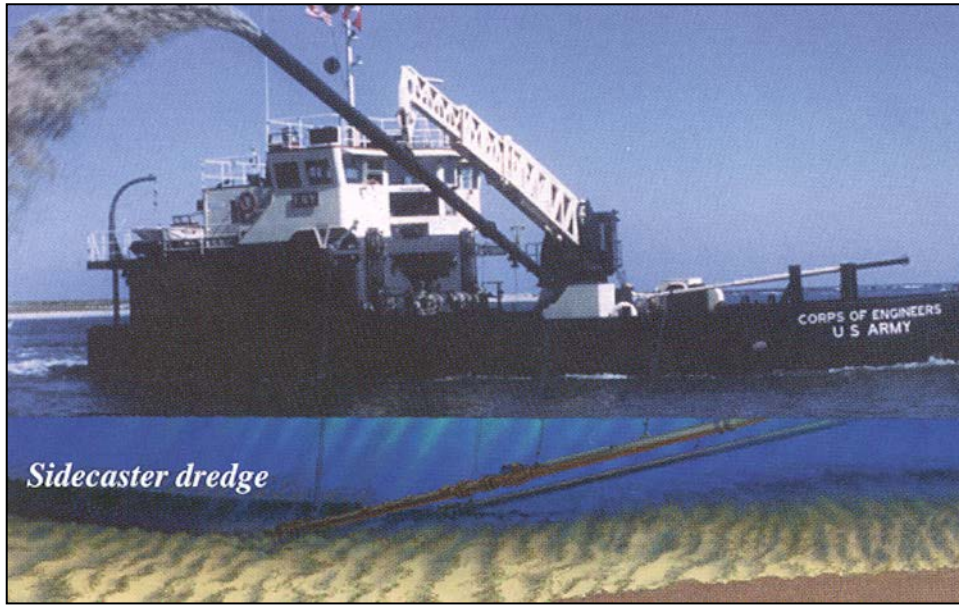

Figure 2-32. Sidecasting Dredge

c. The pumps are started to take the material from the channel bottom and pump it through the discharge boom as the dredge moves along a designated line in the channel prism.

d. If adequate depths are not available across the bar during low tide levels, dredging must be started during higher tide levels. Under these conditions, the cuts are confined to a narrow channel width to quickly attain the flotation depth necessary for dredging to be continued during the low tidal periods.

e. The dredge continues to move back and forth across the bar until the channel dimensions are restored.

f. The discharge can be placed on either side of the dredge by rotating the discharge boom from one side of the hull to the other.

2.24.3 Application. USACE developed the shallow-draft sidecasting dredge for use in places too shallow for hopper dredges and too rough for pipeline dredges. The types of materials that can be excavated with the sidecasting dredge are the same as for the hopper dredges.

2.25.4 Advantages. The sidecasting dredge, being self-propelled, can rapidly move from one project location to another on short notice and can immediately go to work once at the site. Therefore, a sidecasting dredge can maintain a number of projects located great distances from one another along the coastline.

2.25.5 Limitations. The sidecasting dredge needs flotation depths before it can begin to work because it dredges while moving over the shoaled area. Occasionally, a sidecaster will need to alter its schedule to work during higher tide levels periods only because of insufficient depths in the shoaled area. Most areas on the seacoast experience a tidal fluctuation sufficient to allow even the shallowest shoaled inlets to be reconstructed by a sidecasting type of dredge. A shallow-

draft sidecasting dredge cannot move the large volumes of material that a hopper dredge can, and some of the material removed can return to the channel prism because of the effects of tidal and littoral currents. The sidecasting dredge has only open-water placement capability.

## 2.26 Mechanical “Bucket” Dredges.

### 2.26.1 General.

2.26.1.1 There are primarily two types of mechanical bucket dredges used to dredge USACE navigation projects—the clamshell (or grab) bucket dredge, commonly called a bucket dredge, and the backhoe dredge. The bucket dredge is so named because it uses a bucket to excavate the material to be dredged (Figure 2-33). Different types of buckets can fulfill various types of dredging requirements. The buckets used include the clamshell, orange-peel, and dragline types and can usually be quickly changed to suit the operational requirements. The vessel can be positioned and moved within a limited area using anchors and/or spuds. When the spuds are up, the bucket itself can be used to reposition the dredge by “grabbing” the bottom in the direction of desired translation and pulling the dredge that way by taking in wire rope. The barge is normally equipped with two spuds forward (in the front of the barge) and one spud at the aft end of the barge. The latter is a kicking spud for advancing the dredge. Alternatively, the barge can be held in place by anchors, which are attached to winches on the dredge hull and can be placed by an attendant tugboat or by a crane boom. The material excavated is either placed in scows or hopper barges that are towed to the placement areas or it is sidecasted. Buckets used on this type of dredge usually range in capacity from 1 to 30 yd<sup>3</sup> (0.8 to 23 m<sup>3</sup>). The crane is mounted on a flat-bottomed barge, on fixed-shore installations, or on a crawler mount.

2.26.1.2 Bucket dredge production is a function of both the loading (excavation) and hauling components of its operation. Production rates while loading depend on several factors: the size and weight of the bucket, the operating characteristics of the bucket, the type of material to be excavated, the face thickness or bank height of the material, operator efficiency, and the bucket cycle time. Operating characteristics affect the bucket’s fill factor (the decimal equivalent of the percent volume of bucket actually filled) and include the bucket weight, bucket shape, closing edge configuration (toothed or smooth), and closing action. A complete bucket cycle time is defined as the time required to lower the open bucket to the bottom, mechanically grab the material, close the bucket, and then raise, position, and release the bucket either over a waiting scow or to the side (sidecasting). Twenty to thirty cycles per hour are typical, but large variations exist in production rates because of the variability in depths and materials being excavated. The effective working depth is limited to about 100 ft (30 m). Smaller bucket dredges typically do not dredge denser materials while a larger bucket may require structural enhancement (for example, thicker plates to withstand rock excavation).

2.26.1.3 The bucket dredging process usually requires that excavated material be hauled to a placement site by barge (often called a scow). Barges may be purposely built as dump scows of the hopper type with bottom doors or of the split-hull type, or they may be simply flat-deck barges modified to carry the dredged material. The material may be unloaded using gravity dump methods (bottom dump doors or split-hull) by any mechanical means that moves it directly into the placement area, or by a hydraulic unloader. The hydraulic unloader (Figure 2-34) usually consists of a barge-mounted submersible pump or jet pump that unloads the dredged material



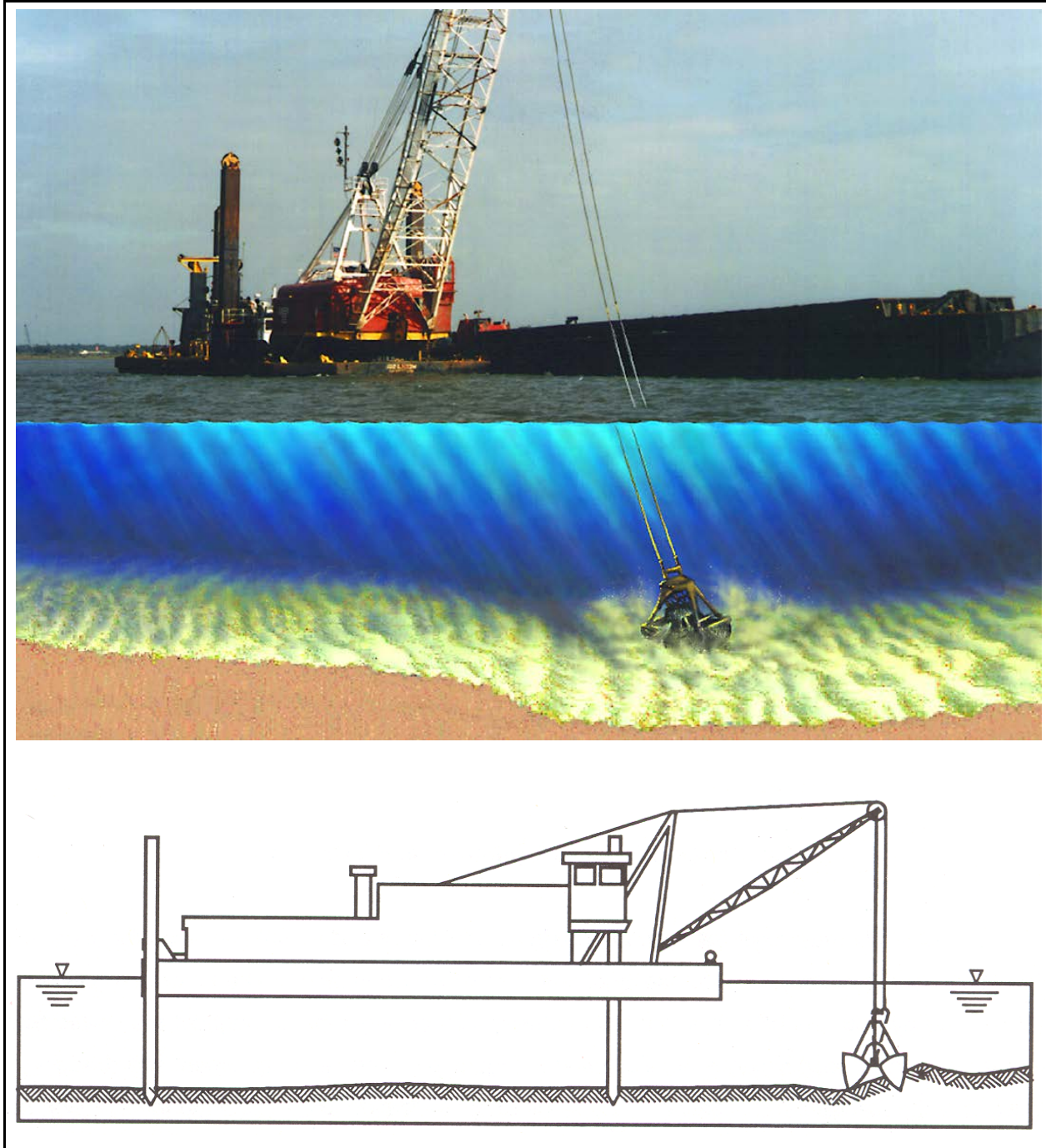

Figure 2-33. Clamshell Bucket Dredge

and pumps it to the placement site. This operation usually involves adding additional water to the dredged material in the barge to allow it to be entrained and pumped through the pipeline. The hauling cycle time of a single scow depends on the time required to load the scow, prepare it for tow, tow it to the placement area, discharge the load, return to dredge site, and tie up back alongside the dredge. Major lost-production time factors include weather and sea conditions,



Figure 2-34. Hydraulic Unloader (Courtesy of Great Lakes Dredge and Dock Company, Oak Brook, IL)

marine traffic and bridge operations, the time waiting for a barge to return from dumping, and mechanical repairs and maintenance.

2.26.1.4 Optimizing the size of the barges and the configuration of the barge and tug fleet are normally an important aspect of mechanical dredge project planning. As a general rule, the goal is to keep the dredging unit operational by providing a sufficient fleet of barges so the dredge does not spend any time just waiting. Tug sizes vary, depending on the size of the barges, the distance to the placement area, and whether offshore service is required. Tugs are generally rated in the range of 1,000-6,000 horsepower (hp).

2.26.1.5 The ability to maintain production while increasing distances to the placement site by adding barges is a very attractive feature of mechanical dredging. In contrast, for hopper dredges the entire dredging unit must be shut down during the trip to the placement site, which limits production and increases costs. As a result, mechanical dredges with scows show economic advantage over hopper dredges at some point as the haul distance becomes longer.

2.26.2 Description of operation. The bucket dredge is not self-propelled, but it can move itself over a limited area during the dredging process by the manipulation of spuds, anchors, and/or bucket. A typical sequence of operation is as follows:

- a. The bucket dredge, scows or hopper barges, and attendant plant are moved to the work site by a tug.
- b. The dredge is positioned at the location where work is to start, and the anchors and spuds are lowered into place.
- c. A scow or hopper barge is brought alongside and secured to the hull of the bucket dredge.
- d. The dredge begins the digging operation by dropping the bucket in an open position from a point above the sediment. The bucket falls through the water and penetrates the bottom material. The sides or jaws of the bucket are then closed using wire ropes operated from the crane. As the sides of the bucket close, material is sheared from the bottom and contained in the bucket compartment. The bucket is raised above the water surface and swung to a point over the hopper barge. The material is then released into the hopper barge by opening the sides of the bucket.
- e. As material is removed from the bottom of the waterway to the desired depth at a given location, the dredge is moved to the next nearby location by using anchors, spuds, or bucket. If the next dredging area is a significant distance away, the bucket dredge must be moved by a tug.
- f. The loaded barges are towed to the placement area by a tug and emptied by bottom dumping if an open-water placement area is used. If a diked placement area is used, the material must be unloaded using mechanical or hydraulic equipment.
- g. These procedures are repeated until the dredging operation is completed.

2.26.3 Application. Bucket dredges may be used to excavate most types of materials except the most cohesive consolidated sediments and solid rock. Bucket dredges usually excavate a heaped bucket of material, but during hoisting, turbulence washes away part of the load. Once the bucket clears the water surface, additional losses may occur through rapid drainage of entrapped water and slumping of the material heaped above the rim. Loss of material is also influenced by the fit and condition of the bucket, the hoisting speed, and the properties of the sediment. Even under ideal conditions, substantial losses of loose and fine sediments usually occur. Because of this, the bucket dredge may employ special buckets if it is being considered for use in dredging applications requiring reduced sedimentation resuspension rates. To minimize the turbidity generated by a clamshell operation, enclosed buckets (Figure 2-35) have been developed for navigation and environmental dredging projects. The edges of these buckets seal more tightly than those of a conventional bucket when the bucket is closed, and the top is covered to minimize the loss of dredged material. Available sizes range from 2.5 to 55 yd<sup>3</sup> (2 to 42 m<sup>3</sup>).





Figure 2-35. Enclosed Bucket

#### 2.26.4 Advantages.

2.26.4.1 The bucket dredge is a rugged machine that can remove bottom materials consisting of clay, hard-packed sand, glacial till, stone, or blasted rock material, but its capacities are somewhat less than the backhoe dredge. It can also be used to pick up large objects, such as boulders, cables, and miscellaneous pieces of trash, that are difficult for hydraulic dredges to handle. Another significant advantage derives from its wire rope connection to the dredge, which gives it the ability to work in sea states not possible for dredges with rigidly attached buckets or excavators. In addition, the digging depth of the bucket, or grab, can be extended by simply adding the amount of wire rope it can carry on its drums. In contrast, increasing the digging depth of most other dredges is a major undertaking. Bucket dredges also require less room to maneuver in the work area than most other types of dredges, and the excavation is precisely controlled so there is less danger of removing material from the foundation of docks and piers when dredging is required near these structures.

2.26.4.2 Bucket dredges are frequently used when placement areas are beyond the pumping distance of pipeline dredges because barges can transport material over long distances to the placement area. This type of dredge operation limits the volume of excess water in the barges as they are loaded. The density of material excavated can be about the same as the in situ density of the bottom material. Therefore, the volume of excess water is minimal, which increases the efficiency of operation in the transportation of material from the dredging area to the placement area and there is less water to handle. The basic crane unit is widely available and can also be used for other marine construction work

2.26.5 Limitations. It is difficult to retain soft, semisuspended fine-grained materials in conventional buckets, barges are required to move the material to a placement area, and production is relatively low compared with the production of cutterhead and dustpan dredges. Mechanical dredges (bucket and clamshell) are also associated with higher suspended sediment concentrations than hydraulic (hopper and cutterhead) methods. Mechanical dredges generate suspended sediments through both the impact of the bucket on the bottom and the withdrawal from the bottom, washing of material out of the bucket as it moves through the water column and above the water surface as well as additional dredged material loss when the barge is loaded (LaSalle 1990). A suspended sediment plume associated with clamshell dredging at its maximum concentration (1,100 mg/L) may extend up to 1,000 m on the bottom (Havis 1988b; LaSalle 1990; Collins 1995). Additional information on excavation characteristics of this type of dredge is presented in Tavolaro et al. (2007).

## 2.27 Mechanical “Backhoe” Dredges.

2.27.1 General. The backhoe dredge uses a bucket that is structurally connected to the dredge by the rigid member configuration as shown in Figure 2-36. To increase digging power, the dredge barge is moored on powered spuds that transfer the weight of the forward section of the dredge to the bottom to provide reaction forces to the digging-induced forces. The maximum bucket size that can be used for a specific project depends on the rated capacity of the excavator, sediment characteristics, and water depth. Bucket sizes generally range from 6 to 25 yd<sup>3</sup> (0.6-19 m<sup>3</sup>). Larger backhoes can excavate to a maximum depth of approximately 80 ft (24 m).

Because the bucket of a backhoe is connected by rigid structural members, more force can be applied to it, allowing these types of dredges to work in “harder” materials (relatively cohesive consolidated materials, weak rock, and debris) than can cable-connected buckets. Backhoe operational characteristics provide relatively high excavation accuracy, and they can work closely around structures. The density of sediment excavated can almost equal its in situ density but, like other conventional mechanical dredges, it may generate a relatively large amount of sediment resuspension at the dredge site.

2.27.2 Description of operation. The backhoe type of dredge is not self-propelled, but it can move itself during the dredging process by manipulation of the spuds and the backhoe arm. A typical sequence of operation is as follows:

- a. The backhoe dredge, barges, and attendant plant are moved to the work site.
- b. The dredge is moved to the point where work is to start; part of the weight is placed on the forward spuds to provide stability.
- c. A barge is brought alongside and moored into place by winches and cables on the backhoe dredge.
- d. The dredge begins digging and placing the material into the moored barge.
- e. When all the material within reach of the bucket is removed, the dredge is moved forward by lifting the forward spuds and maneuvering with the bucket and/or stern spud.



Figure 2-36 Backhoe Dredge *New York* (Courtesy of Great Lakes Dredge and Dock Company, Oak Brook, IL)

f. The loaded barges are towed to the placement area and emptied by bottom dumping if an open-water placement area is used, or they are unloaded by mechanical or hydraulic equipment, if required.

g. These procedures are repeated until the dredging operation is completed.

2.27.3 Application. The best use of the backhoe dredge is for excavating hard, compacted materials, rock, or other solid materials after blasting. Although it can be used to remove most bottom sediments, the violent action of this type of equipment may cause considerable sediment disturbance and resuspension during maintenance digging of fine-grained material. In addition, a significant loss of fine-grained material occurs from the bucket during the hoisting process. The backhoe dredge is most effective around bridges, docks, wharves, pipelines, piers, or breakwater structures because it does not require much area to maneuver; there is little danger of damaging the structures since the dredging process can be controlled accurately. No provision is made for dredged material containment or transport, so the backhoe dredge must work alongside the placement area or be accompanied by barges during the dredging operation.

2.27.4 Advantages. The backhoe dredge is a rugged machine that can remove bottom materials consisting of clay, hard-packed sand, glacial till, stone, or blasted rock material. The power that can be applied directly to the cutting edge of the bucket makes this type of dredge ideal for the removal of hard and compact materials. It can also be used for removing old piers, breakwaters, foundations, pilings, roots, stumps, and other obstructions. The backhoe dredge

requires less room to maneuver in the work area than most other types of dredges, and the excavation is precisely controlled, so there is less danger of removing material from the foundation of docks and piers when dredging is required near these structures. This excavation control can make the backhoe dredge a suitable alternative for dredging channel slopes (for example, in new work where material is hard and compacted). Backhoe dredges are frequently used when placement areas are beyond the pumping distance of pipeline dredges because barges can transport material over long distances to the placement areas. The backhoe dredge can also be used effectively in refloating a grounded vessel. Because it can operate with little area for maneuvering, it can dig a shoal out from under and around a grounded vessel. This dredge type of operation limits the volume of excess water in the barges as they are loaded.

2.27.5 Limitations. It is difficult to retain soft, semisuspended fine-grained materials in the bucket of a backhoe dredge. In addition, barges are required to move the dredged material to a placement area, and the production is relatively low compared with the production of cutterhead and dustpan dredges. As with the clamshell dredge, this mechanical dredge is associated with higher suspended sediment concentrations than hydraulic (hopper and cutterhead) methods. This type of dredge is sometimes limited when working in high-swell conditions. Additional information on excavation characteristics of this type of dredge is presented in Tavolaro et al. (2007).

## 2.28 Special-Purpose Dredge.

### 2.28.1 General.

2.28.1.1 The USACE dredge *Currituck* (Figure 2-37), assigned to the Wilmington District, is an example of a special-purpose type of dredge. Designed to work the same shallow, obstructed inlets as sidecasting dredges, the *Currituck* has the additional ability to remove material from the inlet complex completely and transport it to downdrift eroded beaches. It is a self-propelled split-hull hopper dredge. The vessel is hinged above the main deck so that the hull can open from bow to stern by means of hydraulic cylinders located in compartments forward and aft of the hopper section. The *Currituck* has one hopper with a capacity of 315 yd<sup>3</sup> (240 m<sup>3</sup>).

2.28.1.2 A major difference between the operation of the *Currituck* and that of a conventional hopper dredge is in the placement method; the *Currituck* is designed to transport and deposit the dredged material close to the surf zone area (loaded draft of 8 ft [2.5 m]). This shallow draft allows the *Currituck* to provide a sand-bypassing capability in addition to improving the condition of navigation channels. The *Currituck* excavates material from navigation channels, transports it to downdrift eroded beaches, and releases it where it is needed to provide beach nourishment. After the material has been deposited in the nearshore coastal areas, the dredge backs away and returns to the navigation channel.



Figure 2-37. Dredge *Currituck*

2.28.1.3 The *Currituck* is an effective dredging tool for use in shallow-draft inlets. All of the dredged material is placed in the littoral zone. The *Currituck* can also be used to supplement sidecasting dredges and to transport dredged materials from inlet channels to the nearshore areas of eroded beaches. But the production rate of the *Currituck* is limited by its small hopper capacity. Therefore, it is not effective on major navigation channels. In addition, when the flotation depths are minimal, it is necessary to use a sidecasting dredge to provide access into the project.

2.28.2 Description of operation. The *Currituck* operates in much the same way as does a hopper dredge. The mate steers the vessel through the shoal areas of the channel; the dredge pumps, located in the compartments on each side of the hull, pump material through trailing drag arms into the hopper section; and then, when an economic load is obtained, the drag arms are lifted from the bottom of the waterway, and the dredge proceeds to the placement area.

2.28.3 Application. The *Currituck* provides a sand-bypassing capability in addition to improving the condition of navigation channels. The *Currituck* excavates material from navigation channels, transports it to downdrift eroded beaches, and releases it where it is needed to provide beach nourishment. After the material has been deposited in the near-shore coastal areas, the dredge backs away and returns to the navigation channel.

2.28.4 Advantages. The *Currituck* is an effective dredging tool for use in shallow-draft inlets. All of the dredged material is placed in the littoral zone. The *Currituck* can also be used to



supplement sidecasting dredges and to transport dredged materials from inlet channels to the near-shore areas of eroded beaches.

2.28.5 Limitations. The production rate of the *Currituck* is limited by its small hopper capacity. Therefore, it is not effective on major navigation channels. In addition, when the flotation depths are minimal it is necessary to use a sidecasting dredge to provide access into the project.

## 2.29 Dredge Operating Characteristics and Production Rates.

2.29.1 Operating characteristics. Mechanisms of the major dredge types regarding the dredging process (excavation, removal, transport, and placement) are summarized in Table 2-9, and Table 2-10 summarizes the general operating characteristics of each dredge presented in the preceding sections. Table 2-10 is based on navigation projects; environmental dredging considerations are not included (see paragraph 2.32 for more information regarding environmental dredging). It provides these operating characteristics as “general rules of thumb” regarding each dredge type’s performance in a given area. A wide range of values is given to account for the various sizes of plant within each class and different site-specific conditions. The interaction between these two primary drivers ultimately determines the respective operating characteristic value that may or may not fall within the ranges provided in Table 2-10.

### 2.29.2 Dredge production rates.

2.29.2.1 Dredge production rate is usually defined as the number of cubic yards of dredged material (referenced to in situ density) dredged during a given period. Depending on the analysis intent, the given period may be an hour, day, or week, or other interval, but a usual production rate is expressed in  $\text{yd}^3/\text{hr}$ . Many factors that determine dredge production rates. According to Bray (1975), these factors can be broken down into the following:

- a. Factors that affect the time available for the actual dredging operation of moving material from the dredging prism to the placement site.
- b. Factors that affect the efficiency of dredging operations while they are being performed.

2.29.2.2 Factors that affect longer-term production rates include the length and number of shifts worked, programmed stops (that is, required maintenance stops), and non-programmed stops (for example, breakdowns, bad weather, and refueling).

2.29.2.3 Factors that affect average hourly production rates can be subdivided into the following:

- a. Fixed, or dredge, factors (for example, pump size, cutter power, hopper capacity, and speed of vessel).
- b. Natural factors (for example, sediment characteristics, depth, wind, waves, currents, and debris).

c. Operational factors (for example, operator and crew efficiency, transport method, and distance to the placement site).

Table 2-9. Dredge Excavation, Removal, Transport, and Placement Processes

Dredge Type	Excavation Method	Removal Method	Transport Method	Placement Method
Hydraulic Dredges				
Hopper dredge	Hydraulic suction Hydraulic erosion Mechanical dislodgement using knives or blades	From bottom to dredge vessel in hydraulic pipeline as a sediment-water slurry	Sediment settles in hopper; vessel moves to placement site	Bottom discharge or pumpout
Sidecasting dredge	Hydraulic suction Hydraulic erosion Mechanical dislodgement using knives or blades	From bottom to dredge vessel in hydraulic pipeline as a sediment-water slurry	From dredge vessel through discharge boom from one side of the hull	
Cutterhead dredge	Mechanical dislodgement using rotary cutter Hydraulic suction Hydraulic erosion	From bottom to dredge vessel in hydraulic pipeline as a sediment-water slurry	From dredge vessel to placement site in pipeline as a sediment-water slurry <sup>1</sup>	Direct discharge on land, water, or beneficial use site
Dustpan dredge	Direction suction Impingement scour using water	Same as cutterhead dredge	Same as cutterhead dredge	Same as cutterhead dredge
Mechanical Dredges				
Bucket dredge	Mechanical dislodgement, scooping with bucket	Wire rope with clamshell or dragline	Barge, land-based conveyor belt, trucks, material may be sidecasted	Bottom discharge, pumpout, or mechanically to unload; Direct discharge from belt, truck, or bucket
Backhoe dredge	Mechanical dislodgement, scooping with backhoe bucket	Rigid structural members with backhoe bucket		

<sup>1</sup> May be pumped into barges and moved to the placement site.

Table 2-10. Summary of Dredge Operating Characteristics

Dredge Type	Percent Solids in Slurry by Weight <sup>1</sup>	Turbidity Caused	Open-water Operation	Vessel Draft ft	Approximate Range of Production Rates yd <sup>3</sup> /hr	Dredging Depths, ft		Limiting Wave Height ft	Limiting Current	Lateral Dredging Accuracy <sup>2</sup> ft
						Minimum	Maximum			
Cutterhead	10-20%	Avg.	Yes <sup>3</sup>	3-14	100-5,000 <sup>4</sup>	3-14	12-65 <sup>5</sup>	< 3	6	2-3
Hopper	10-20%	Avg.	Yes	12-31	500-5,000 <sup>7</sup>	10-28	140 <sup>8</sup>	< 10	6	10
Bucket	in situ	High <sup>9</sup>	Yes <sup>3</sup>	<sup>10</sup>	30-2,000	0 <sup>11</sup>	100 <sup>12</sup>	< 3 <sup>13, 14</sup>	6	1
Backhoe	in situ	High	Yes <sup>3</sup>	<sup>10</sup>	30-1,000	0 <sup>11</sup>	85	< 3 <sup>13</sup>	6	1
Dustpan	10-20%	Avg.	No <sup>15</sup>	5-14	1,200-5,700 <sup>16</sup>	5-14	75	< 3	6	2-3
Sidecasting	10-20%	High	Yes	5-9	325-650	6	25	< 7	6	10
Special-purpose	10-20%	Avg.	Yes	5-8	250 avg	8	20	< 7	6	10

<sup>1</sup> Percent solids could theoretically be 0, but these are normal working ranges. Percent solids =  $\frac{\text{weight of dry solids}}{\text{weight of wet slurry}}$

<sup>2</sup> Vertical accuracies depend on dredge type and site-specific conditions (geotechnical characteristics, pen or sheltered waters, etc.). Refer to Tavoraro et al. (2007) for more detailed information on various excavation accuracies of different dredge types in varying site-specific conditions.

<sup>3</sup> Limited operation in open water possible, depending on hull size and type, anchoring system used, and wave height.

<sup>4</sup> Production for a cutterhead dredge is dependent on suction and discharge line diameter, pump horsepower, cut face height, sediment characteristics, ladder swing width and speed, digging depth, and discharge line length and vertical lift. The ranges presented in this table represent only an approximate upper and lower range.

<sup>5</sup> With submerged dredge pumps, digging depths have been increased to greater than 100 ft (30 m).

<sup>6</sup> Literature implies that water current hinders dredging operations, but references avoid establishing maximum current limitations. For most dredges, the limiting current is probably in the 3- to 5-knots range, with hopper and dustpan dredges able to work in currents of around 7 knots.

<sup>7</sup> Production for a hopper dredge is dependent on suction and discharge line diameter, pump horsepower, hopper capacity, cut face height, sediment characteristics, transport distance to placement site, vessel dredging and sailing speeds, digging depth, and drag head configuration. The ranges presented in this table represent only an approximate upper and lower range.

<sup>8</sup> With submerged dredge pumps, digging depths have been increased to greater than 140 ft (43 m).

<sup>9</sup> Can be lower if an enclosed bucket is used.

<sup>10</sup> Depends on the floating platform; if it is barge-mounted, the draft is approximately 5-6 ft (1.5-1.8 m).

<sup>11</sup> Zero if used alongside waterway; otherwise, the draft of the vessel will determine this number.

<sup>12</sup> Demonstrated depth; theoretically, it could be used much deeper.

<sup>13</sup> Depends on the supporting vessel dimensions and anchoring system used and the scow dimensions.

<sup>14</sup> Theoretically, unaffected by wave height; digging equipment is not rigid.

<sup>15</sup> Most dustpan dredges are not designed for open-water operation, but the dustpan *Beachbuilder* has a modified hull and anchoring system that increases its operational capability in open water.

<sup>16</sup> Production for a dustpan dredge is dependent on suction and discharge line diameter, pump horsepower, cut face height, sediment characteristics, advance rate, digging depth, and discharge line length and vertical lift. The ranges presented in this table represent only an approximate upper and lower range.



2.29.2.4 Specific factors that affect production of the various dredge types used in USACE navigation projects are discussed in the preceding dredge descriptions. Determination of detailed dredge production rates is required for dredging contract cost estimates. The USACE Cost Estimating Dredge Estimating Program was developed to ensure that cost estimates for dredging projects can be prepared accurately and efficiently, and to produce a fair and reasonable cost for hopper, pipeline, and mechanical dredges. This USACE program calculates a production rate for each of these types of dredges for preparation of the government cost estimate for dredging contracts. The dredge production rate is required to determine an estimated unit price per cubic yard. The U.S. Army Engineer Division, Huntsville, offers a week-long (40 hours) Dredge Estimating course, whose objective is for the student to be able to develop a detailed, fair, and reasonable cost estimate for maintenance and new-work projects, and also to be able to discuss the overall policies and guidance affecting dredge estimates. If interested in taking this course, USACE employees should check with their Training Officer for details.

### 2.30 Agitation Dredging Techniques.

#### 2.30.1 Introduction.

2.30.1.1 Agitation dredging is the process of removing bottom material from a selected area by using equipment to raise it in the water column and allowing currents to carry it from the project area. In the most detailed study available on agitation dredging techniques, Richardson (1984) evaluated past agitation dredging projects and presented guidelines and recommendations for using agitation dredging. Two distinct phases are involved in agitation dredging: suspension of bottom sediments by some type of equipment and transport of the suspended material by currents. The main purpose of the equipment is to entrain bottom material into the water column. Natural currents are usually involved in transporting the material from the dredging site although the natural currents may be augmented with currents generated by the agitation equipment. Agitation dredging is accomplished by methods such as hopper dredge agitation, prop wash, vertical mixers or air bubblers, rakes or drag beams, and water jets. Based on the work done by Clausner (1993) and Richardson (1984), the following agitation dredging techniques are presented in this section—hopper dredge, prop wash, and rake or beam dragging agitation. While Water Injection Dredging (WID) is included in this section, it is (as described below) not considered to be strictly agitation dredging due to the sediment transport being driven primarily by generated density current, not ambient currents.

2.30.1.2 The main objective of agitation dredging is the removal of bottom material from a selected area. If the material is suspended but redeposits shortly in the same area, only agitation (not agitation dredging) has been accomplished. The decision to use agitation dredging should be based primarily on the following factors:

a. Technical feasibility. The equipment to generate the required level of agitation must be available, and the agitated material must be carried away from the project area by currents (either ambient or generated by the dredging equipment).

b. Environmental feasibility. Agitation dredging should not cause unacceptable environmental impacts.

c. Economic feasibility. Agitation dredging must be determined the most cost-effective method for achieving the desired results; it should not affect the costs of other dredging projects downstream by increasing dredging volumes.

2.30.1.3 The environmental considerations discussed in Appendix B, “Dredging Environmental Conditions,” also apply to all agitation dredging techniques. The short-and long-term physical and chemical conditions of the sediments influence the environmental consequences. These factors should be considered in evaluating the environmental risk of a proposed agitation dredging technique.

#### 2.30.2 Hopper dredge agitation.

2.30.2.1 Description of operation. Refer to paragraph 2.22 for a general description of hopper dredges. In agitation dredging, hopper capacity is of secondary importance compared with pumping rates, mobility, and overflow provisions. In hopper dredge agitation, the conventional dredge-haul-dump operating mode is modified by increasing the dredging mode and reducing the haul-dump mode. It has been reported that hopper dredge agitation can allow a project to be maintained with a dredge that is relatively small compared to the size dredge required for a conventional dredge-haul-dump operation. There are two types of hopper dredge agitation: intentional agitation produced by hopper overflow and auxiliary agitation caused by drag heads and propeller wash. Since the latter is present in all hopper dredge operations and since it is difficult to quantify separately from hopper overflow, both types are measured together when reporting hopper dredge agitation effectiveness.

2.30.2.2 Application. Agitation hopper dredging can perform the same maintenance functions as conventional hopper dredging if the following conditions are satisfied: sediments are fine-grained and loosely consolidated, currents are adequate to remove the agitated sediments from the project area, and no unacceptable environmental impact results from the agitation dredging.

2.30.2.3 Advantages. Because currents, not equipment, transport most of the sediment from the project area during agitation hopper dredging, the following advantages are realized: hopper dredge agitation costs can be several times less per cubic yard than hopper dredge hauling costs, and smaller hopper dredges can be used to maintain certain projects.

2.30.2.4 Limitations. Hopper dredge agitation should be applied only to specific dredging sites and not be used as a general method to maintain large areas. The following limitations must be noted when considering this dredging technique for use at a site: hopper dredge agitation cannot be used in environmentally sensitive areas where unacceptable environmental impacts may occur, and sediments and current conditions must be suitable for agitation dredging.

### 2.30.3 Water injection dredging (WID).

#### 2.30.3.1 Description of operation.

a. A vessel-mounted pump/fluidizing assembly is used in WID methodology to inject large volumes of water directly into sediment voids at relatively low pressures. The pump/injection head assembly is mounted on a barge designed to be propelled by a pushboat (Figure 2-38). Given sufficient penetration, this injection process can increase the pore volume and pore water pressure such that a loss of grain-to-grain contact is achieved. This state of fluidization creates a low-viscosity water-sediment mixture. The depth of injection-water penetration, and thus the degree of fluidization, depends on physical properties of the sediment and water jet characteristics of the injection head. When noncohesive sand is being dredged, the primary sediment characteristics that influence fluidization rates are grain size and permeability. For dredging silt, the in situ density, viscosity, and permeability are the primary factors, and in clays the cohesive strength exerts the major influence. The pressure gradient formed by differences in density between the heavier water-sediment mixture and ambient water creates a gravity-driven density current that induces mixture flow. The spatial and temporal characteristics of this density current (flow pattern and relative densities) are influenced by the composition and initial degree of fluidization of the sediment, site bathymetry, and ambient currents.



Figure 2-38. Water Injection Dredge

b. The WID-generated density current transports shoal material to deeper water, where it can settle without impeding navigation or where it can be carried even farther away by stronger ambient currents. Thickness of the density current, or the height above the bottom that the fluidized sediment is lifted in the water column, is dependent upon grain size. The WID density current does not absolutely require a sloping bottom to flow, but a slope can assist the density current in a manner that can be likened to an “underwater avalanche.” The amount of slope is especially important when using WID in fine sand (0.2 mm) and coarser materials due to their higher fall velocities relative to that of silt-sized particles. Performance in fine-grained sediments

is reduced as cohesion and consolidation increase. Highly plastic (fat) clays cannot be effectively dredged using WID. As sand grain sizes increase, the distance these grains can be transported is reduced. Each dredge site has to be evaluated individually for its suitability regarding WID application. Site conditions govern this applicability by influencing production rates that depend on sediment characteristics, bathymetry, and the local hydraulic regime. For example, a dredge cut consisting of coarse-grained sand might be cost effectively dredged by WID in one location if favorable factors (such as steep bottom slopes, close deposition area, and beneficial ambient currents) exist. But at another site with different bottom conditions, the large-grained sand might require the dredge to “rehandle” the same sediment several times, thus increasing cost per volume unit.

c. WID does not absolutely require ambient currents to transport the sediment out of the dredge cut because of the gravity-induced (density difference) component of flow of the density current. This component of flow is just another type of exchange current similar to a salt wedge intrusion into fresh water. In normal operation, WID lifts the fluidized sediment from the bottom a height of 1-3 m. Per Bruun (1990) divides agitation dredging into controlled and noncontrolled methods. An example of a noncontrolled method includes the overflow method from hopper dredges; but WID, because of the amount of control inherent in its operation, is classed as a controlled agitation dredging method.

2.30.3.2 Applications. Dredging typically starts at the lower end of a dredge cut adjacent to the placement area and then proceeds with the goal of producing a smooth downslope gradient to the placement area, thus requiring working from the lower edge of the dredge cut back to the upper edge. In a harbor, a central channel is dredged, followed by dredging out from the center channel. Removal of high spots associated with sand waves or irregular bathymetry can reduce production rate initially. Production rates in sand can range from 100 to 400 m<sup>3</sup>/hr and in silt up to 1,500 m<sup>3</sup>/hr or more.

2.30.3.3 Advantages. For appropriate locations where favorable bottom material and bathymetry exist, WID can offer several advantages:

- a. In optimum conditions WID is capable of very high production rates.
- b. WID can rapidly move from one project location to another on short notice and can immediately go to work once at a site.
- c. Because WID does not require pipelines, anchors, or attendant vessels to operate, the reduction in numbers and types of required operating equipment directly translates into a reduction of required workforce levels and attendant operating costs.
- d. WID provides fewer impediments to navigation due to the absence of discharge pipelines, spuds, swing wires, etc. For certain types of dredging projects (for example, locks where traffic can cause substantial delays), the ability of WID to quickly avoid vessels and resume dredging can result in substantially more operating hours compared with other more conventional equipment.

e. Because the injection head merely rides on the surface of the sediment as opposed to actively digging into it, WID allows safer operations with a reduced chance of damage to submerged structures, pipelines, utility cables, and other items.

2.30.3.4 Limitations. WID has the following limitations:

- a. It can be used only where in-water placement of dredged material is allowed.
- b. WID can effectively operate only where favorable conditions exist; sediments, bathymetry, and current conditions must all be suitable.
- c. WID cannot be used in contaminated sediment where unacceptable environmental impacts occur.

2.30.4 Prop wash agitation.

2.30.4.1 General. Prop wash agitation dredging is performed by vessels especially designed or modified to direct propeller-generated currents into the bottom shoal material. The agitated material is suspended in the water column and carried away by a combination of natural currents and prop wash currents. Unintentional prop wash agitation dredging often occurs while vessels move through waterways. This type of sediment resuspension is uncontrolled and, therefore, is often considered undesirable.

2.30.4.2 Description of operation. The prop wash vessel performs best when work begins at the upstream side of a shoal and proceeds downstream with the prop wash-generated current directed downstream. The vessel is anchored in position, and prop wash-generated currents are directed into the shoal material for several minutes. The vessel is then repositioned and the process is repeated.

2.30.4.3 Application. Prop wash agitation dredging has been successfully used in coastal harbors, river mouths, river channels, and estuaries. It is a method intended for use in loose sands and in maintenance-dredged material consisting of uncompacted clay and silt. Cementing, cohesion, or compaction of the bottom sediment can make prop wash agitation dredging difficult to perform, and waves may cause anchoring problems with the agitation vessel. Optimum water depths for prop wash agitation dredging in sand are between two and three times the draft of the agitation vessel. Based on studies by Richardson (1984), the average performance of vessels specially designed for prop wash agitation range from 200 to 300 yd<sup>3</sup>/hr in sand and a little higher for fine-grained material.

2.30.4.4 Advantages. The major advantages of prop wash agitation dredging are related to economics. In some areas, prop wash agitation dredging has been found to cost 40-90% less per cubic yard dredged than conventional dredging methods.

2.30.4.5 Limitations. The limitations on prop wash agitation dredging are as follows:

- a. Prop wash agitation seems best suited for areas with little or no wave action.

b. Prop wash agitation should be applied in water depths less than four times the draft of the agitation vessel.

c. The sediments must be loose sands, silt, or clay.

d. It cannot be used where unacceptable environmental impacts could occur.

#### 2.30.5 Bed-levelers, Rakes, and Drag Beams.

2.30.5.1 Bed-levelers, drag beams, and similar devices work by being pulled over the bottom (usually by a vessel), mechanically loosening and “dragging” the bottom material and raising some portion of it into the water column to be carried away by natural currents. Bed-levelers, while attaining some agitation dredging, are used primarily to reduce the height of bottom material by “knocking down,” or redistributing, this material into deeper locations.

2.30.5.2 A vessel towing one of these devices may provide some resuspension and transport by its prop wash. A wide range of dredging rates has been reported for bed-levelers. Although these rates vary because they are highly dependent upon site conditions, it has been reported that the cost of dredging by bed-levelers can be less than 10% of the cost for conventional dredging. Data show a definite correlation between dragging speed and dredging rate. The advantages and limitations for bed-levelers are similar to those reported for other dredging techniques reported by Richardson (1984).

2.30.5.3 The primary uses of bed-levelers by U.S. contractors have been to smooth the bottom following dredging or to reduce the height of dredged material placement mounds that have reached an excessively high elevation. USACE dredging contracts may contain general statements such as the following: “Should any shoals, lumps, or other lack of contract depth be disclosed by this examination, the Contractor will be required to remove same by dragging the bottom or by dredging.” Since dragging the bottom (bed-leveling) is not a pay item per se, tugs and drag beams for bed-leveling have previously not been included in the plant and equipment lists of contractor’s bids. Bed-leveling is a far less expensive method of achieving desired grade than redredging. Hence, this is a common method for achieving final grade by hopper dredge, bucket dredge, and clamshell dredge contractors. Bed-leveling has also been used by cutterhead dredge contractors for reducing the heights of placement mounds.

2.30.5.4 One reason for the use of bed-levelers on both new-work and maintenance dredging projects is that modern multibeam survey systems have significantly improved in recent years over previously used single-beam survey systems, and they have the capability to show high places above desired grade. A hopper dredge drag head, especially one equipped with a turtle excluder device, tends to fall off ridges, dig deep, and follow the same path with successive passes. This tends to dredge trenches and leave ridges that may need to be removed. If the bottom is hard material, as in new-work dredging, the requirement to get absolutely every spot to grade is typically deemed critical, so the contractor is required to bring the high spots down to desired grade. Bed-leveling, given the appropriate bathymetric and hydrodynamic conditions, can be an efficient method for lowering these high spots, typically being less costly than returning with a hopper dredge for multiple passes. The use of bed-levelers in lieu of hopper dredges to clean up may also reduce the possibility of turtle takes.

2.30.5.5 Historically, the drag bars first used as bed-levelers were probably sections of spuds or I-beams. The bed-levelers shown in Figures 2-39 through 2-41 for Bean Dredging Company, Weeks Marine, Inc., and Great Lakes Dredge and Dock Company, respectively, are engineered, company-fabricated devices resembling a bulldozer blade or a box beam reinforced with massive amounts of weight to penetrate into either soft or hard materials, even small pieces of rock on occasion. They are suspended from work barges by A-frames, and have winches to maintain control of the amount of penetration into the bottom and to determine how much of a ridge is removed per pass. A typical bed-leveler may vary from 30 to 50 ft in length and weigh anywhere from 25 to 50 tons. The power of the tug used to push or pull the work barge from which the bed-leveler is suspended usually varies from 1,000 to 3,000 hp.

2.30.5.6 In calmer waters, the work barge can be pushed or pulled by the tug in a straighter line. The stronger the currents, the more difficult it is to position the barge. Bed-leveling can be performed behind hopper dredges under relatively calm wave conditions, but bed-leveler operations can be constrained in marginal or severe wave conditions that routinely occur in entrance channel situations where the bottom material is sandy. Bed-leveling is less effective in cohesive sediments where the drag beam tends to “ride over” the seafloor instead of knocking down the high spots. In addition, loose granular material is sometimes redistributed by the wave climate; thus, bed-leveling may not be necessary in these locations.



Figure 2-39. Bed-Leveler Suspended by an A-Frame on a Work Barge  
(Photo Courtesy of Bean Dredging Company, New Orleans, LA)





Figure 2-40. Bed-Leveler Suspended from a Work Barge (Photo Courtesy of Weeks Marine, Inc., Cranford, NJ)



Figure 2-41. Bed-Leveler Suspended by an A-Frame on a Work Barge (Photo Courtesy of Great Lakes Dredge and Dock Company)



2.30.5.7 Typical bed-leveler towing speeds range from 1 to 2 knots. Bed-levelers are used more often in soft sediment maintenance materials and new-work clay, and even with small pieces of rock, but they are used much less often in sand. In very soft mud, it may be possible to take a foot or even more in a pass while in stiffer clay it is more likely that a half-foot or even less may be moved per pass (2-4 in. per pass is a typically representative number). The number of passes required depends entirely on the type of material being moved, the height of the ridge to be leveled, and the weight of the bed-leveler.

2.30.5.8 Bed-levelers have been used for many years around coastlines of the United States at any place where the contract bid element is a unit price item. Bed-levelers are not usually used where hopper dredging is performed on a rental basis and payment is by the hour instead of on a unit price per cubic yard basis. Bed-levelers of one design or another (ploughs, I-beams, anchor chains, and so on) have been used following dredging by different types of dredges (hoppers, clamshells, and buckets) in several USACE Districts. While not all Districts have used bed-levelers following dredging by hopper dredges, all have used bed-levelers following dredging by other type dredges (clamshell or bucket).

2.31 Dredging Instrumentation. Dredging instrumentation has undergone significant changes over the last several decades due to the availability of improved instrumentation and low-cost computing and data storage as well as increased environmental awareness and regulations. Improved instrumentation has contributed to optimization of the dredging process because it improves the crew's ability to determine where they are dredging, where they are placing the dredged material, and how they are dredging (production instrumentation). The significant types of instrumentation that have contributed to these dredging improvements are described in the following paragraphs.

#### 2.31.1 Positioning.

2.31.1.1 Global Positioning System. The use of the Global Positioning System (GPS) has dramatically impacted dredging by providing an accurate, accessible, horizontal (x,y) positioning capability. The NAVSTAR GPS is a passive, satellite-based navigation system operated and maintained by the Department of Defense. Its primary mission is to provide passive global positioning/navigation for land-, air-, and sea-based strategic and tactical forces. A GPS receiver is simply a range measurement device; distances are measured between the receiver antenna and the satellites, and the position is determined from the intersections of the range vectors. These distances are determined by a GPS receiver that precisely measures the time it takes a signal to travel from the satellite to the station. This measurement process is similar to that used in conventional pulsing marine navigation systems and in phase comparison electronic distance measurement land surveying equipment. There are basically two general operating modes from which GPS-derived positions can be obtained: absolute positioning and relative or differential positioning (DGPS). This variety of operational options results in a wide range of accuracy levels that may be obtained from the NAVSTAR GPS. Accuracies can range from 100 m down to the subcentimeter level. Increased accuracies to the subcentimeter level require additional observing time and, until recently, could not be achieved in real time. Selection of a particular GPS operating and tracking mode depends on the user application. EM 1110-1-1003 provides technical specifications and procedural guidance for surveying with GPS. EM 1110-2-1003 presents recommendations for GPS dredge positioning and control.

2.31.1.2 Three-dimensional (digging point) positioning. Integration of a cutterhead, bucket, or drag head depth measurement (z) system with DGPS (x,y) horizontal positioning allows three-dimensional determination of the excavation point. Methods of determining “digging” depth for the various types of dredges include bubbler (pneumatic) systems, pressure transducers, inclinometers/geometry relationship, and “payout” holding line sensors. The attitude of the dredge can be input by system components, such as gyro-compasses, electric compasses, or multiple GPS stations. Electronic tide or river stage gages may be required to provide water level (datum) corrections for the excavation point. Dredges also use tide boards (staff gages) or real-time kinematic GPS to make water level corrections. The two most common types of water level gages are pressure and acoustic transducers, which can be mounted on the river or seabed or in stilling tubes in the near vicinity of the dredging project. Water level data can be linked to the three-dimensional positioning system by cellular telephone, radio, or satellite.

#### 2.31.2 Hydraulic dredge production instrumentation.

2.30312.1 The need for accurate evaluation of production in dredging operations has been evident for a long time. In the 1960s, the hydraulic dredge operator had at his disposal only the measurements of pump revolutions per minute, power used, and suction and discharge pressures to estimate production. The suction (vacuum) and discharge pressures were recorded on circular chart paper (smoke charts) like the one shown in Figure 2-42.

2.31.2.2 The total rate of flow or the density (or specific gravity) of the solid-water mixtures was not known. The first improvement was the application of magnetic flowmeters to the dredging industry—this provided the total rate of flow (water plus solids). The next improvement was the development of a nuclear density gage that provided an instantaneous reading of the density of solid-water mixtures being pumped. Since the magnetic flowmeter is relatively expensive, a Doppler flowmeter was developed later (Herbich et al. 1992).

2.31.2.3 The most desired information in an efficient hydraulic dredging operation is the accurate determination of the amount of solids passing through the dredge pump. A magnetic or Doppler flowmeter and a nuclear density gage have been utilized individually by the dredging industry to determine the flow velocity of the slurry and dredged material density, respectively.

2.31.2.4 Since dredging operations are now much larger, in both volume and cost, a higher degree of accuracy and efficiency is required. As there are no simple relations between pump speed, slurry density, discharge pressure, and solids flow rate, production metering systems have been developed. The development of a single integrated production metering system represents a higher degree of automation. With this type of instrumentation, the leverman or drag tender can determine instantaneous values of flow velocity and slurry density and see the manner in which density and flow velocity interact with each other to affect solids production rate. It usually includes a “totalizer,” which gives a continuous indication of total production (project total or shift total), eliminating the need for computations to determine the total production.



a. Nuclear density gage. The nuclear density gage measures density using the energy absorption method. An example of one of the nuclear density gages onboard the dredge *McFarland* is shown in Figure 2-43. A radioactive source, usually cesium 137 or cobalt 60, emits gamma-ray energy through the discharge pipe. The rays are absorbed in proportion to the density of the slurry, and a detector either of the ion chamber or scintillation type handles the gamma-ray energy. The ion chamber detector is a gas-filled device with a polarizing voltage applied to it. When gamma rays strike the device, the energy ionizes the gas creating a small current that is amplified and sent to the transmitter. Scintillation type detectors are made of certain plastic materials that give off a pulse of light when struck by gamma rays. A photo-multiplier tube converts the light pulses to voltage pulses that are then sent to the transmitter. The transmitted energy is finally converted into a linearized output that indicates density changes (Herbich et al. 1992). A Nuclear Regulatory Commission (NRC) license is required to supervise the use of the nuclear density gage. The licensee receives radiation safety training, maintains the required NRC records, and performs periodic wipe tests. The wipe test is a procedure in which the radiation source is wiped with a small cotton cloth, which is then analyzed to detect radiation and assure compliance with the NRC safety standard.



Figure 2-43. Nuclear Density Gage

b. Flowmeters. There is a variety of different ways to measure flow velocity in dredging applications.

(1) Magnetic flowmeter. The magnetic flowmeter, based on the principle of electromagnetic induction, is designed to measure the flow of conductive liquids in a pipe. Two electromagnetic coils surround a pipe made of antimagnetic materials and produce a magnetic field at right angles to the flow direction. As a conductive liquid passes the metering section, the lines of force from the magnetic field are cut, producing a low-level voltage at the stainless steel pick-up electrodes. The electrodes measure the potential difference, which is proportional to the flow rate

and independent of the solids concentration. Both AC systems and pulsed DC systems are available; however, for dredging applications the AC system provides the broadest possibilities.

(2) Doppler sonic flowmeter. The Doppler flowmeter uses the theory of the Doppler effect—there is an apparent change in the frequency of sound, light, or radio waves as a function of motion. These meters consist of a piezoelectric crystal transducer, a Doppler frequency receiver, and a transmitter. The transmitter sends a continuous ultrasonic signal through the pipe wall and into the liquid stream at an angle to the direction of flow. The sound waves are reflected by particles, bubbles, or other discontinuities in the liquid back to the receiver. The difference between the transmitted and the reflected frequencies, called the Doppler shift, is analyzed, and the flow rate of the slurry is displayed in velocity units (Herbich et al. 1992).

(3) Elbow meter. An elbow meter indicates slurry velocity by measuring the pressure differential between a pressure tap on the inside and a pressure tap on the outside of the discharge elbow. The differential pressure is measured by means of diaphragms and is converted into an electrical signal by a differential pressure transducer. The signal corrects for the slurry density and shows the velocity on a display, which may be analog or digital.

2.31.2.8 The production metering system has a number of different output indicators, but it usually features a display combining both slurry velocity and slurry density. The data from the flowmeter, which measures the total rate of flow of the solids, and the density meter, which measures the specific gravity of the pumped mixture, are fed into the production metering system. It indicates the instantaneous total rate of solids flow per unit time in a variety of output parameters (such as cubic meters [yards] per hour and tons per hour). It can also include a “totalizer,” which gives a continuous indication of total production (project total or shift total), eliminating the need for postoperation computations to determine the total production.

2.31.2.9 The U.S. Army Engineer Research and Development Center (ERDC) has conducted laboratory studies (Pankow 1989) on production meter components. Several density gages and flowmeters manufactured by different companies were evaluated for accuracy and reliability in a closed test loop. Different grain-size materials, slurry concentrations, and velocity regimes were used for the study. The results indicated that the various calibrated nuclear density gages were very consistent in their measurements of density and showed values within 1-5% of each other. Although the preferred pipe orientation for density gages is vertical, they perform better when the pipe is rotated 45° from the horizontal. The magnetic flowmeters were also fairly consistent in their measurements and showed values within 6% of each other. Slurry velocity and slurry concentration had little to no effect on the accuracy of the magnetic flowmeters. However, the data for the Doppler flowmeters showed distinct differences. Though the data for each meter were fairly self-consistent, the Doppler flowmeters showed significant differences from the control meter while the magnetic flowmeters produced measurements fairly close to those of the control meter. Slurry velocity had some effect on the accuracy of the Doppler flowmeter.

2.31.3 Hopper dredge instrumentation. In recent years the application of instrumentation to hopper dredges has accelerated rapidly. Instrumentation has become an integral part of hopper dredge operations. First, the operator needs to know what is going on: information regarding the position, drag depth, and production of the dredge. Second, the dredge owner needs information on the performance of the dredge to track project progress, determine maintenance requirements,

and estimate costs of future projects. Finally, the project manager needs information to ensure that the project is being carried out in compliance with specifications and that payments are justified. The list of instrumentation currently available on American hopper dredges includes those shown in Table 2-11.

Table 2-11. Hopper Dredge Instrumentation

Instrument	Application
Electronic positioning (DGPS)	Horizontal position
Drag depth vertical position	Depth in cut
Electronic tide gage	Correct vertical position to tidal datum
Load (yardage) meter	Load versus time record
Hopper level sensors	Measure level of material in hopper
Density/velocity meter	Slurry density and velocity
Fathometer	Depth below hull

#### 2.31.3.1 Load (yardage) meter.

a. The yardage meter or load meter system has been in use by the USACE since before 1954. The first experimental yardage meter system capable of reading tons of solids was installed on the hopper dredge *Essayons* to measure loads by the displacement method, replacing the procedure of sampling the hopper bins to determine the volume of settled solids and the solids in suspension in the bin water. This method is based on the principle developed by the Greek mathematician Archimedes (287-212 B.C.), that the weight of the water displaced by a floating object is equal to the weight of the object. In the case of the hopper dredge, the weight of the load placed in the hoppers results in an increase in the draft of the dredge as it displaces an equal weight of water. Displacement versus draft curves provided with the curves of form for the hopper dredge, as with any ship, provide the means to measure this weight increase.

b. The hopper load weight is determined by measuring the hopper loaded and unloaded weights of the entire vessel, then subtracting the unloaded value from the loaded value. To accomplish this, the change in draft of the vessel is measured, and this measurement is converted into displacement from the curves of form (displacement curves) of the vessel. Draft measurements are usually taken with at least two pressure sensors, as shown in Figure 2-44, one mounted forward and one mounted aft on the underside of the vessel as close to the keel as possible. The pressures measured by this technology are proportional to the hull depth.

2.31.3.2 Hopper level sensors. By measuring the hopper load volume and weight, the average density can be calculated. The hopper weight is determined by the displacement method described previously. The level of dredged material in the hopper is measured in order to derive the hopper load volume from the hopper ullage chart. The hopper level can be measured by level sensors mounted over the hopper, as shown in Figure 2-44. These sensors are usually ultrasonic transducers (Figure 2-45) that emit acoustic waves and detect the energy reflected from the dredged material surface. Similar to a hydrographic survey, the distance between the transducer and acoustic reflector is based on the time interval required for the acoustic energy to travel from and back to the transducer. The sensors are usually mounted on the forward and aft ends over the



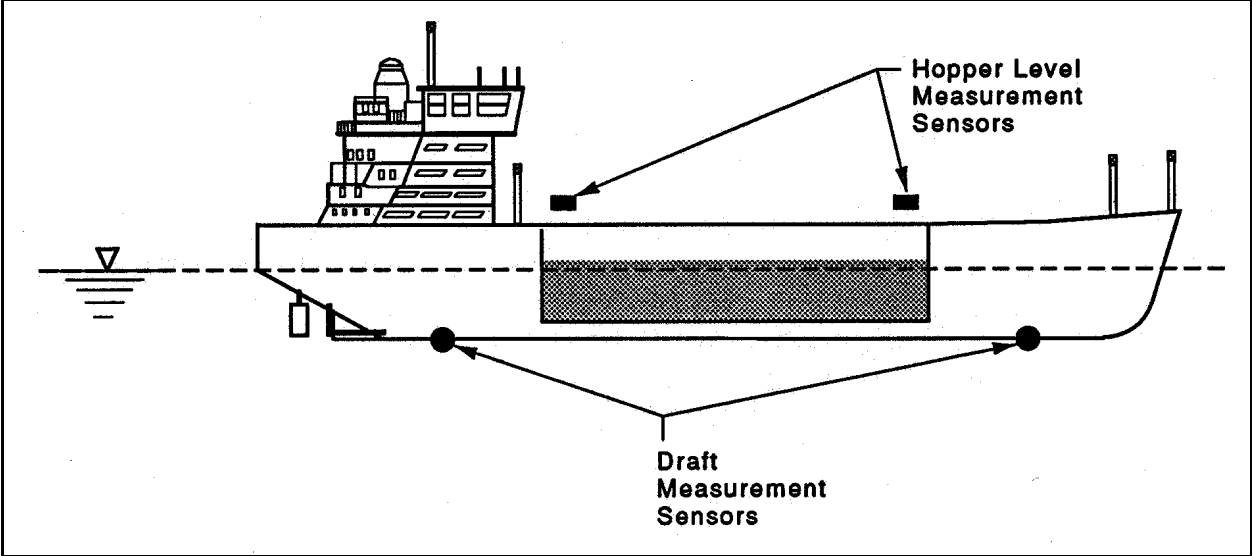

Figure 2-44. Draft and Hopper Level Sensors



Figure 2-45. Acoustic Hopper Level Sensor

31 Jul 15

hopper as close to the center line as possible (to offset error caused by the vessel list). One disadvantage of this technology is that if the hopper load has foam on its surface, the sensors reflect off it instead of the slurry surface. Another disadvantage is that the sensor transducer must remain relatively clean to function correctly.

2.31.3.3 Hopper Dredge Automatic Light Mixture Overboard (ALMO). The ALMO uses the flow and density meter to optimize the hopper-filling process by allowing only mixture with a predetermined specific gravity to be loaded. Two valves activated by data received from the density gage and flowmeter are incorporated into the pump delivery system. One of the valves causes light mixture to be discharged overboard while the other directs mixture of adequate density to the hopper. The density values can be preset in accordance with the nature of the dredging process.

2.31.4 Hydraulic pipeline dredge monitoring. Various USACE Districts have recorded pipeline dredge operating parameters for contract quality assurance purposes (Rosati and Welp 1999). Table 2-12 illustrates the variety of different parameters monitored by these districts. For example, Louisville District has monitored suction and discharge pressures, recordings of pump rpm's, slurry density and velocity in the pipeline, the suction pipe inlet depth, swing cable and cutterhead pressures, and the three-dimensional location of the suction inlet. "This data forms the basis of monitoring the performance and effectiveness of the dredge under the conditions encountered at the dredge site" (Chapman 1994). A Windows-based microprocessor is required to display parameters continuously on an integrated video information console and record time-averaged data (converted from analog to digital). The device or system is to be equipped with an electronically scalable crossed-pointer display, indicating slurry velocity, slurry density, and instantaneous production (Figure 2-46), for use by the leverman and the Government's representative or inspector.

Table 2-12. Dredging Parameters Monitored by USACE Districts (from Rosati and Welp 1999)

District	Parameters										
	Suction Vacuum	Discharge Pressure	Pump RPM	Cutterhead 2D Position	Cutterhead Depth	Slurry Velocity	Slurry Density	Swing Cable Pressure	Cutterhead Pressure	Dredge-Mounted Fathometer	Vessel Heading
New Orleans	X	X	X								
Louisville	X	X	X	X	X	X	X	X	X		X
Mobile											
<i>Tuscaloosa</i>	X	X	X	X						X	X
<i>Columbus</i>	X	X	X	X						X	X
<i>Panama City</i>	X	X		X		X	X				X
San Francisco				X		X					X



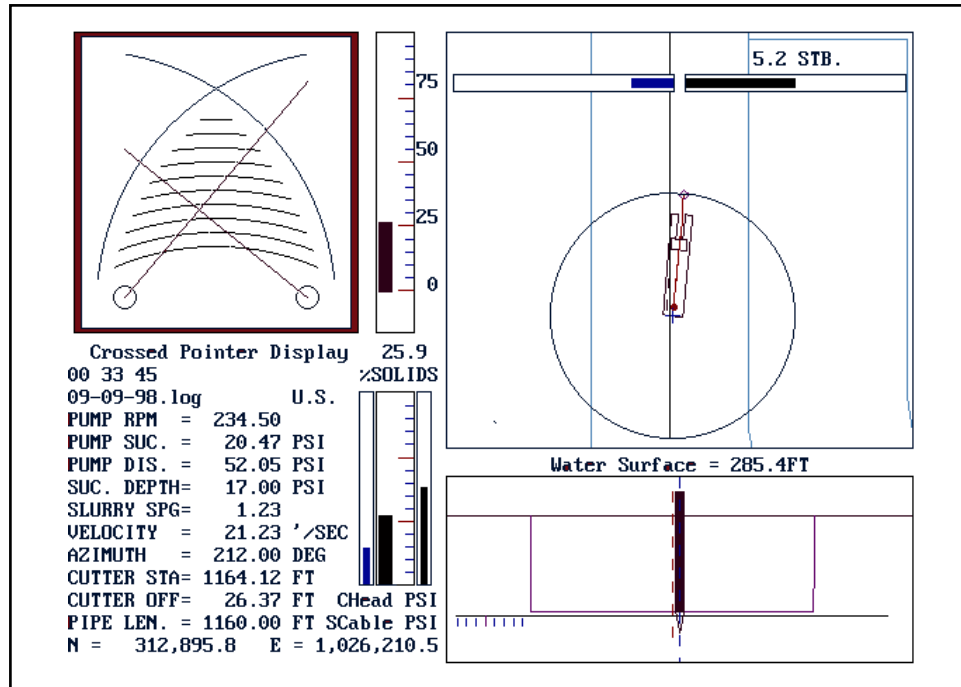

Figure 2-46. Example of Louisville District-Required Dredging Parameters (Courtesy of Louisville District)

### 2.31.5 National Dredging Quality Management (DQM) Program.

2.31.5.1 Overview. The National Dredging Quality Management (DQM) Program (<http://dqm.usace.army.mil/>) is a partnership between the USACE and the dredging industry. Its mission is to provide USACE dredging managers nationwide with a standardized, automated, and low-cost remote monitoring, analysis, and documentation system for USACE dredging projects employing both Government-owned and contract dredges. As the replacement for the original Silent Inspector (SI) desktop tools, this next-generation dredging monitoring system provides timely web-based data access, multiple reporting formats, and full technical support, including dredge certifications, data quality control, and database management for dredging projects. DQM currently monitors all hopper dredges within the US as well as the larger scows, which are used with mechanical dredges. Figure 2-47 shows all USACE Districts currently using DQM. Continued program and tool enhancement is planned, including support for mechanical and pipeline dredges.

2.31.5.2 Benefits to Government. DQM provides a number of benefits to Government:

- a. 24x7 coverage of operations.
- b. Valuable data for environmental monitoring compliance.
- c. Fast response to public and environmental concerns.
- d. Reduced paperwork.

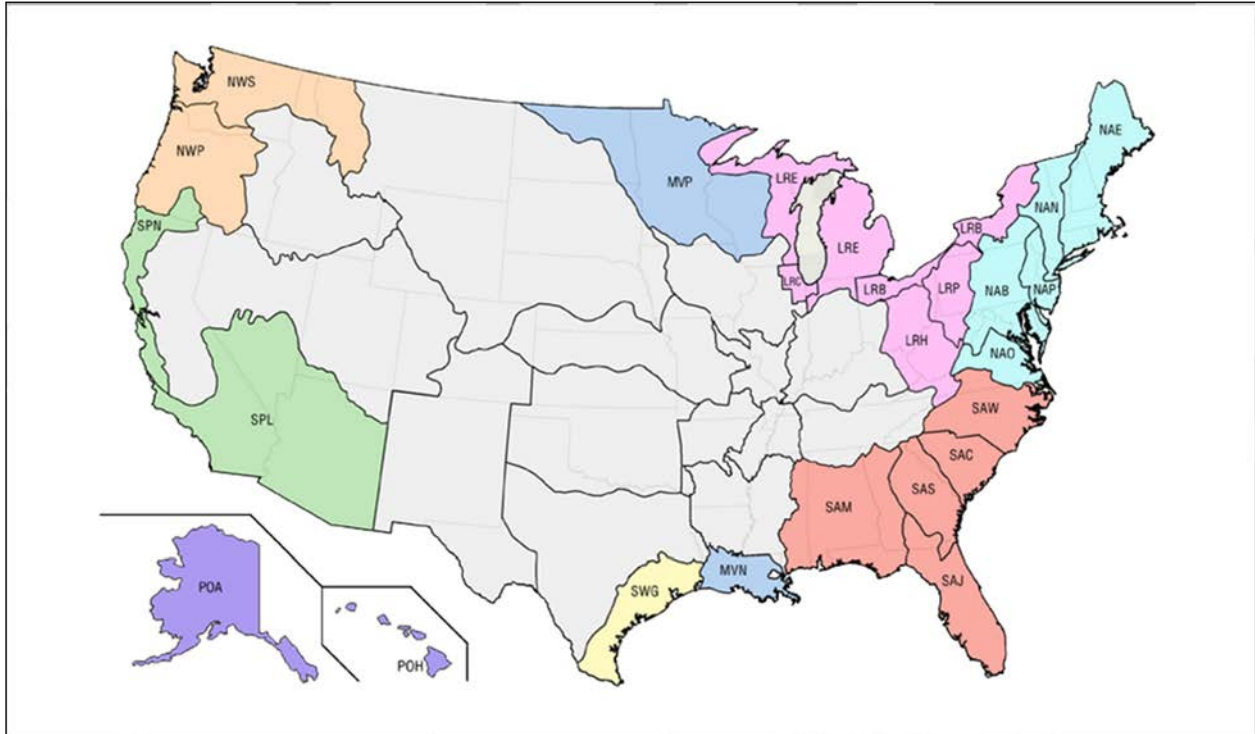

Figure 2-47. USACE Districts Currently Using DQM

- e. Improved project management.
- f. Flexible scheduling of inspectors.

2.31.5.3 Benefits to Industry. DQM also provides a number of benefits to industry:

- a. Standardized data collection and reporting.
- b. Fast start to data collection.
- c. Standard base for dispute resolution/avoidance.
- d. Reliable digital record of operations/performance.

2.31.5.4 Data Collection. Onboard the dredge, multiple sensors and instruments continuously monitor dredge activities, operations, and efficiency. (Figure 2-48 identifies the sensors onboard a hopper dredge.) The information collected by these sensors is routed in near real time via the Internet to the National DQM Support Center for data processing, storage, and publishing (Figure 2-49). When an Internet connection is not available, data is stored locally and then transmitted as soon as a connection is available. A complementary suite of web-based DQM tools gives USACE dredging managers the ability to view project operations, produce disposal plots, and then export and analyze dredge operation data.

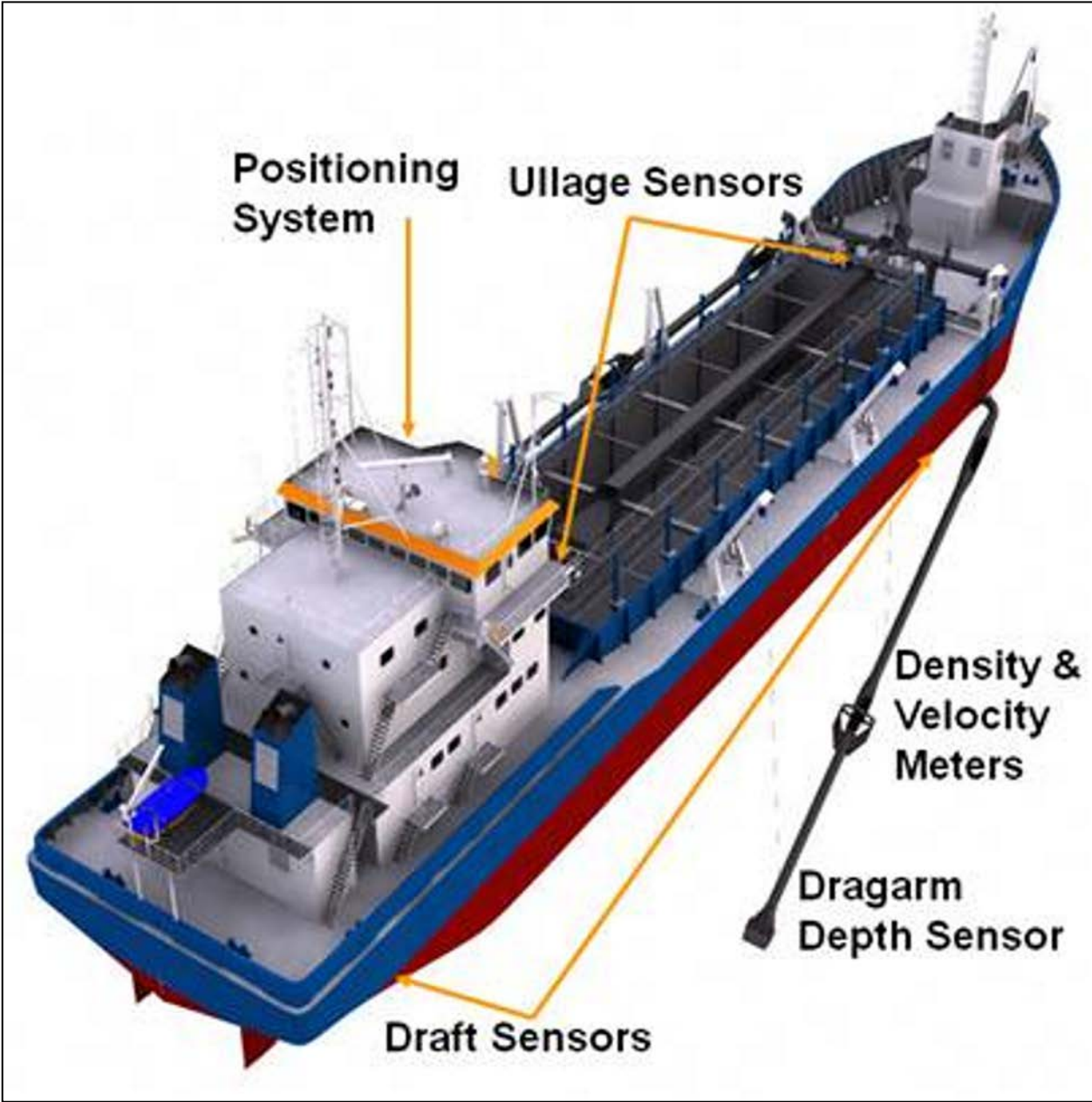

Figure 2-48. Hopper Dredge Sensors

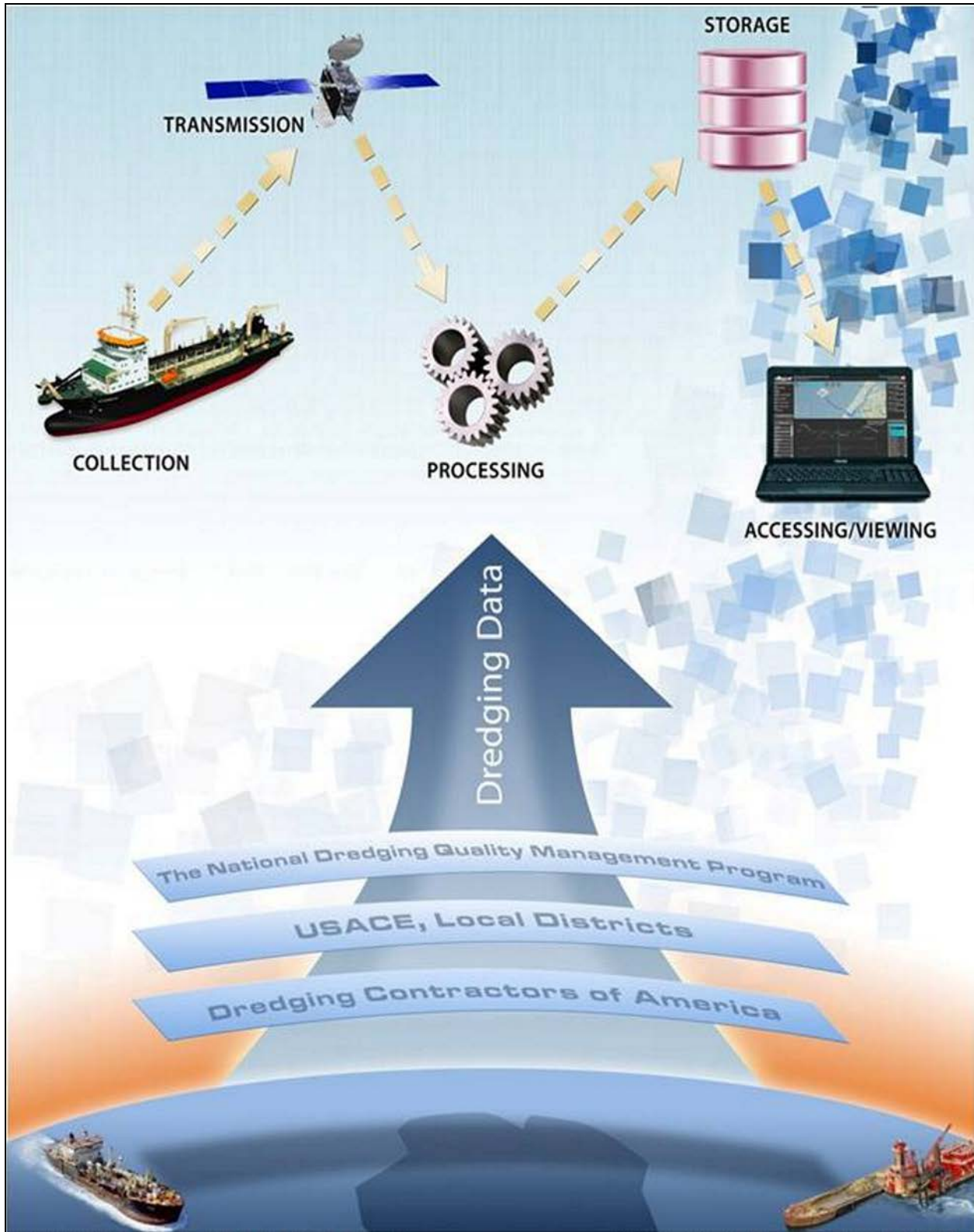

Figure 2-49. National Dredging Quality Management (DQM) Program Data Collection

2.31.5.5 Specifications. In order to interpret the data and base decisions on those interpretations, it is necessary to maintain a certain level of confidence in the accuracy of the data collected, compiled, and transmitted to the DQM database by a dredge's electronic instrumentation. Therefore, to ensure that the DQM Program is collecting quality data, performance-based specifications clearly define the minimum standards for accuracy and resolution of the instrumentation as well as the expectations for frequency of data receipt.

2.31.5.6 Data collection. All shipboard sensors are the property of the contractor, who is required to maintain them. The contractor also purchases the required computer hardware for the DQM software, and USACE installs software. Both hoppers and scows collect data and compute measurements specific to that dredging type. Table 2-13 identifies the instrumentation onboard a hopper dredge and some of the data parameters transmitted to the National DQM Support Center. The instruments in the left column measure and transmit various values; the parameters in the right column are calculated from those values. For example, the values collected by the draft sensors are used to calculate the vessel weight (displacement). Additional parameters are added as a need is identified.

2.31.5.7 Dredging Quality Management On-Board Software (DQMOBS). The DQMOBS is used on hopper dredges to capture the dredging contractor's serial data string and transmit it in near real time to the National DQM Support Center. Figures 2-50a and 2-50b show daytime and nighttime views of the DQMOBS, respectively.

2.31.5.8 Certification. To guarantee that dredge instrumentation is capable of meeting the standards identified in the specifications, the National DQM Support Center oversees annual instrumentation checks of the data collection systems on dredge plants nationwide. These checks are based on the DQM specifications and not on the terms of any specific contract. National DQM Center Certification indicates the following:

- a. The dredge plant is equipped with instrumentation that meets the minimum data collection standards for the DQM Program.
- b. The contractor has the equipment to calibrate the required sensors and transmit data.
- c. The contractor has documented pertinent information regarding the instrumentation system.
- d. The contractor has demonstrated that personnel with the expertise to maintain the instrumentation are available.

Certification is valid for one year from the date of the instrumentation check and is contingent upon the system's ability to continuously meet the performance requirements outlined in the DQM specifications. The instrumentation must be rechecked if any yard work produces a modification to displacement (change in dredge lines or repositioning/repainting of hull marks), to bin volume (change in bin dimensions or addition/subtraction of a structure), or in sensor type or location.



2.31.5.9 Data Monitoring. Timeliness of data receipt is essential to managing dredging contracts; therefore, incoming data is monitored to ensure that all active contracts are transmitting data appropriately. While the National DQM Support Center is not responsible for quality control of the incoming data (that is, telling the contractor how to fix issues), it does, however, provide the first line of quality assurance on that data by using computerized checks on received data to detect outliers or anomalous values. In addition, visual examination of the data is performed by individuals with expertise in interpreting instrumentation and dredging operations. DQM web-based tools can be used to view project operations, produce disposal plots, and export data.

Table 2-13. Hopper Dredge Instrumentation and Calculated Data Parameter Values

Instrumentation	Calculated Data Parameter Values
Positioning System	Date and Time
Open/Close Sensor	Vessel Longitude and Latitude
Draft Sensors	Draghead Longitude and Latitude
Ullage Sensors	Dredge Course
Drag Head Depth Sensor	Dredge Speed
Density Meter	Dredge Heading
Velocity Meter	Hull Status
Pump RPMs	Load Number
Computer (DQM receives the data string)	Tide (Vertical Correction)
Telemetry System	Fore and Aft Draft
	Fore and Aft Ullage
	Hopper Volume
	Displacement
	Empty Displacement
	Draghead Depths
	Slurry Density in Dragarms
	Slurry Velocity in Dragarms
	Pump RPM
	Minimum Pump Effort
	Pumping Water
	Material Recovery
	Pumpout

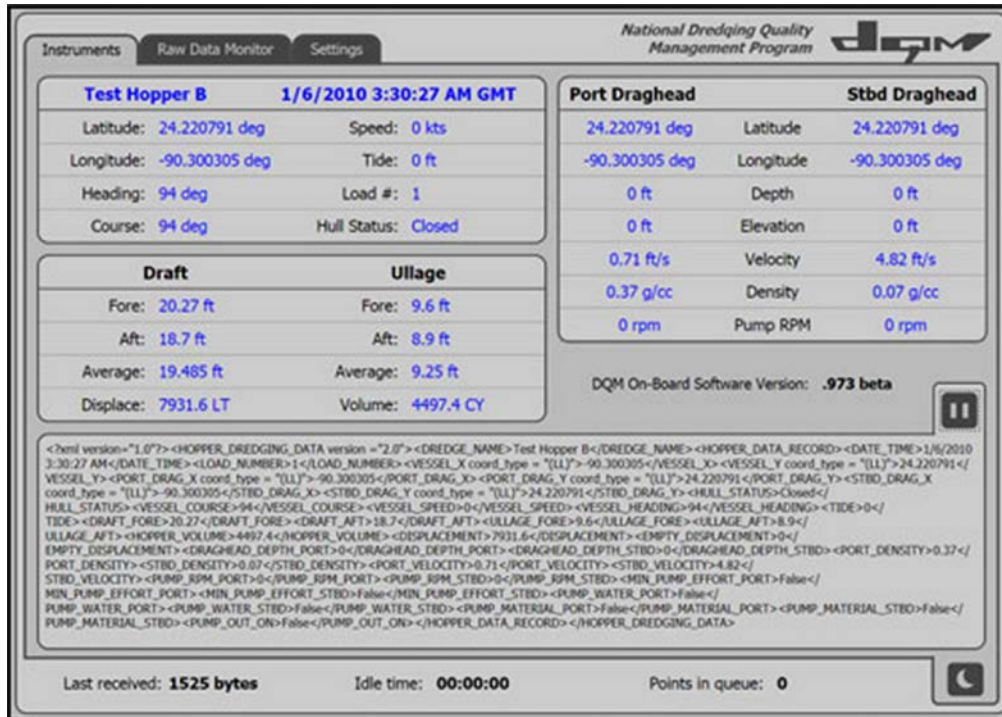

a. Daytime View



b. Nighttime View

Figure 2-50. Hopper Dredge DQMOBS Interface

2.31.5.10 One of the computed hopper dredge data values is Tons Dry Solids (TDS), a measure of the hopper load volume and weight in order to determine the quantity of “dry solids” that it contains. By applying the values for the dry solid (dredged material) specific density and in situ water density in a formula with the hopper load weight and volume (which indirectly measures the hopper load average density), the total quantity of the dry solids can be calculated. Because TDS measures the amount of dry solids material that is actually being transported, the dredge performance can be determined for contract management purposes; TDS measurement provides feedback to the dredge crew and management for optimizing production. TDS also allows sediment removal to be described in terms of mass balance, improving the understanding of dredged material fate. Welp and Rosati (2000) present more information about TDS measurement and its use in Europe and USACE.

2.31.5.11 Other applications of DQM include monitoring to ensure environmental compliance (for example, for threatened and endangered species and open water dredged material placement). Section 2.39 describes several applications that illustrate how DQM, in conjunction with an Enterprise Geographic Information System (eGIS), can be used as a dredging contract compliance quality assurance (QA) tool.

2.30.5.12 Training. DQM Viewer training is currently available on the National DQM Program website (<http://dqm.usace.army.mil>); the National DQM Support Center is planning to provide additional training modules in the future. The National DQM Support Center also provides training for local USACE districts on DQM tools and technology, DQM requirements, and health and safety issues related to working in the field. Large-group training is delivered on site while webinars are available for smaller groups.

## 2.32 Environmental Dredging.

2.32.1 Introduction. While there are certainly environmental issues associated with navigation dredging, particularly where sediments are highly contaminated, navigation dredging usually does not involve sediment remediation. The term environmental dredging generally refers to remediation or cleanup projects where removal of contaminated sediment from the waterway to enhance environmental quality is the primary objective of the project. For navigation dredging, the main concern is restoration of navigable water depths through cost-effective removal of sediment without unacceptable adverse environmental effects. In the case of environmental dredging, the overriding concern is often controlling contaminant releases to the waterway during dredging and/or efficient removal of the contaminated material. Palermo and Averett (2003) review technical considerations for environmental dredging and summarize the state of the art with respect to equipment selection and operational practice. The major considerations for environmental dredging include the following:

- a. Objectives, goals, and performance standards for the project.
- b. Equipment availability and selection.
- c. Removal rate and precision of removal.



- d. Resuspension of sediment during the dredging process.
- e. Release of dissolved contaminants to water or volatilization of contaminants to air due to resuspension.
- f. Residual contaminated sediment left in place following the dredging operation.
- g. Transport of the dredged material for subsequent treatment or placement.

#### 2.32.2 Considerations for selecting environmental dredging equipment.

2.32.2.1 The goal of any environmental dredging project is to remove the contaminated sediment as efficiently and economically as possible without unacceptable adverse impacts to the environment. The dredging industry offers a wide variety of equipment suitable for various situations, including a number of innovations targeted to environmental dredging. Site-specific conditions often limit the type of equipment that can be used. General factors that should be considered in selecting equipment for environmental dredging include the following (Averett, Perry, and Miller 1990):

a. Size of the project. The volume of material and the project time schedule for removal dictate the production rate required for the dredge. Small projects on the order of a few thousand cubic meters can be efficiently dredged with small, portable equipment. Low production rates may not be appropriate for projects involving much larger volumes of material. However, the sizing of handling and treatment facilities for contaminated sediments may limit the dredging rate.

b. Dredging depth. The depth of the sediment and the thickness of the contaminated layer both affect the type and size of dredging equipment selected. Where a relatively thin layer (<0.5 m) is to be removed, equipment capable of precisely removing this slice of material is favored. Because of the cost of handling and disposition of the dredged material, the volume of contaminated sediment removed should often be minimized at the expense of lower production rates incurred by specifying precise and accurate cutting depths. Contracting for environmental dredging projects is generally bid on a dredging time, performance criteria, or job basis rather than a cost per unit volume.

c. Physical characteristics of the sediment. Particle size, degree of compaction, cohesiveness, and bulk density affect dredge selection. Most contaminated sediments are fine-grained. Dredging techniques designed primarily for sands may not be appropriate for fine-grained material.

d. Contaminants. The types and concentrations of contaminants in the sediment should be considered. Hot spots for a site require more careful operation and control. Contaminants that are more soluble or more volatile or that have large oil pockets have greater potential for release during dredging.

e. Debris. The presence of large rocks, timbers, trees, trash, and other discarded materials often limits the type of dredge that can be used. Large quantities of debris may preclude the use of hydraulic dredges and favor mechanical bucket dredges.

f. Physical site restrictions. Water depths, currents, tides, wave height, channel widths, obstructions, overhead restrictions, and access to the site may limit the size (width, length, and draft) of the equipment that can be used for a site.

g. Distance to the placement or treatment site. If the placement or treatment site is distant from the dredging area, hydraulic pipeline transport may not be feasible. Longer haul distances require barge transport. The economics of barge or scow transport require that the solids content of the dredged material be as high as possible with little free water.

h. Compatibility with placement or treatment. Some treatment technologies require slurry feed and are compatible with hydraulic pipeline dredges whereas other treatment technologies cost more for material with a higher water content. Wastewater treatment requirements, a significant cost component, increase for hydraulic dredging. Hydraulically removed material may have less potential for volatile losses at a placement site. A systems approach involving the entire process train—dredging with subsequent transport, pretreatment, treatment and placement—is recommended for environmental dredging.

i. Availability. Many environmental dredging technologies have been developed in North America, Europe, and Japan. However, not all of these are available in the United States, limiting the evaluation of innovations that appear to be promising.

2.32.2.2 Palermo, Francingues, and Averett (2003) evaluate the capabilities and advantages and disadvantages of various equipment types commonly considered for environmental dredging, considering published field experience. A list of specific factors related to removal efficiency, resuspension and release, residual sediment, and compatibility with placement is provided along with discussion of the relative effectiveness of the various equipment types in addressing each of the factors. This information is incorporated in newly developed USEPA guidance for sediment remediation and environmental dredging (USEPA 2005) available at <http://www.epa.gov/superfund/health/conmedia/sediment/guidance.htm>.

2.32.2.3 USEPA (1994) and Palmero et. al. (2008) present additional information and technical guidelines on environmental dredging and guidance on the planning, design, and implementation of actions to remediate contaminated bottom sediments. Francingues and Palermo (2005) review the basic types of silt and turbidity curtains used in navigation and environmental dredging projects. The emphasis is on the state of the practice and circumstances under which silt curtains function best. A checklist has been prepared and is provided to aid the designer or reviewer of silt curtains to select, design, specify, deploy, and maintain silt curtains at dredging projects. This note also serves to update and supplement earlier guidance (Johanson 1977; JBF Scientific Corporation 1978) published on the application and performance of silt curtains.

## Section IV Dredging Environmental Considerations

### 2.33 Introduction.

2.33.1 This section presents environmental considerations associated with different types of dredge excavation and placement processes. Equipment and controls to manage, or mitigate, impacts at the excavation (digging) point, as opposed to the point of placement, are also described. Equipment and controls to manage, or mitigate, impacts at open-water sites are described in Chapter 3, “Open-Water Placement,” and those used at confined placement sites are described in Chapter 4, “Confined (Diked) Placement.” The impacts of dredging on plants and animals consist of short- and long-term effects. These effects may result from suspended sediments, turbidity, direct physical impact, changes in habitat, and, in certain situations, by contaminant levels.

2.34 Sediment Resuspension Due to Dredging. The nature, degree, and extent of sediment resuspension around a dredging operation are controlled by many factors:

- a. The characteristics of the dredged material such as its size distribution, solids concentration, and composition.
- b. The nature of the dredging operation, such as the dredge type and size, discharge cutter configuration, discharge rate, and operational procedures being used.
- c. The characteristics of the hydrologic regime in the vicinity of the operation, including salinity and hydrodynamic forces (for example, waves and currents).

In addition to sediment resuspension, contaminant mobilization and dissolved oxygen reduction may also be concerns for certain dredging projects. The relative importance of these factors varies from site to site. Appendix B, “Dredging Environmental Considerations,” describes sediment resuspension characteristics of different types of dredges, discusses dissolved oxygen reduction and contaminant mobilization induced by dredging, and presents operational measures that can be used to reduce resuspension potential. Software has been developed to simulate sediment resuspension characteristics generated from dredging operations.

#### 2.34.1 Particle Tracking Model (PTM).

2.34.1.1 The Particle Tracking Model (PTM) is a Lagrangian particle tracker that allows the user to simulate sediment movement in a flow field, including the erosion, transport, settling, and deposition of sediment particles. It was developed jointly by the Dredging Operations and Environmental Research (DOER) Program and the Coastal Inlets Research Program (CIRP) and operates in the Surface-water Modeling System (SMS) interface. Each transported particle is representative of an amount of mass of sediment, and particle movement is based on a complex series of transport mechanisms. In addition to predicting sediment transport pathways and sediment fate, the model produces maps of sediment transport processes, such as sediment mobility, which can be useful in understanding sediment behavior. Demirbilek et al. (2005a) describe the PTM interface; Davies et al. (2005) describe the features and capabilities of the

PTM for analysis of sediment transport and sediment pathways in coastal waters, estuaries, rivers, and waterways; and Demirbilek et al. (2005b) present a tutorial with examples of the PTM. Model theory, implementation, and example applications are provided in MacDonald et al. (2006) and Lackey and McDonald (2007). Additional information about the PTM is available on the DOER website (<http://el.erdc.usace.army.mil/dots/doer/ptm.html>).

2.34.1.2 The PTM is designed to address the following processes and project needs:

- a. Sediment mobility.
- b. The fate of mobilized sediment.
- c. The source or origin location of material in areas experiencing sedimentation.
- d. The effects of anthropogenic activity on sediment pathways.
- e. The fate of material released during a dredging and placement operation.
- f. The stability and fate of in-place sediment, including dredged material mounds, sediment caps, and contaminated sediment deposits.

2.34.1.3 PTM uses waves and currents as forcing functions, which are developed through other models and input directly to PTM. Hydrodynamic and wave conditions are generated for PTM using wave and circulation models. PTM input files include an unstructured grid and time-series for the wave and hydrodynamic conditions. These input files are from the CIRP's Coastal Modeling System (CMS) or ADCIRC 3D and depth-averaged hydrodynamic models and CMS-Wave and STWAVE (Steady State spectral WAVE) wave models. Other models can also be used as input by first converting their output to CMS, ADCIRC, or to CMS-Wave and STWAVE formats. The input hydrodynamic files can be in either ASCII or XMDF (<http://www.xmswiki.com/xms/XMDF>) hydrodynamic binary data formats. The XMDF (.h5) format is random access and can significantly reduce run time. The SMS interface automatically converts ASCII files to this format.

2.34.1.4 As illustrated in Figure 2-51, PTM operates in SMS Version 11 ([http://www.xmswiki.com/xms/SMS:SMS\\_User\\_Manual\\_11.1](http://www.xmswiki.com/xms/SMS:SMS_User_Manual_11.1)), which allows considerable flexibility in converting hydrodynamic model results from one format to another. This figure shows the model grid with bathymetry input in a harbor. PTM can read and write the XMDF binary file format supported by SMS, greatly reducing file sizes and access times, and it uses a calendar and clock-based time system to synchronize hydrodynamic, wave, sediment source, and simulation times. The basic structure of PTM is simple—a region (geometry) with bathymetric and sediment data is defined. Flow and, if applicable, wave data are supplied to the model, and particles are released into the flow. The computations then proceed through time, modeling behavior (such as entrainment, advection, diffusion, settling, deposition, and burial) of the released particles. Two types of calculations are performed at each time-step of PTM: Eulerian (mesh- or grid-based) calculations are required to determine the local characteristics of the environment, and Lagrangian (particle-based) calculations are required to determine the behavior of each particle. The material to be modeled in PTM is released from sources. Refer to

Demirbilek et al. (2005a, 2005b, 2012a, 2012b), Davies et al. (2005), and MacDonald et al. (2006) for details about PTM source specifications, types of Eulerian and Lagrangian calculations performed, and modes of operation of the model.

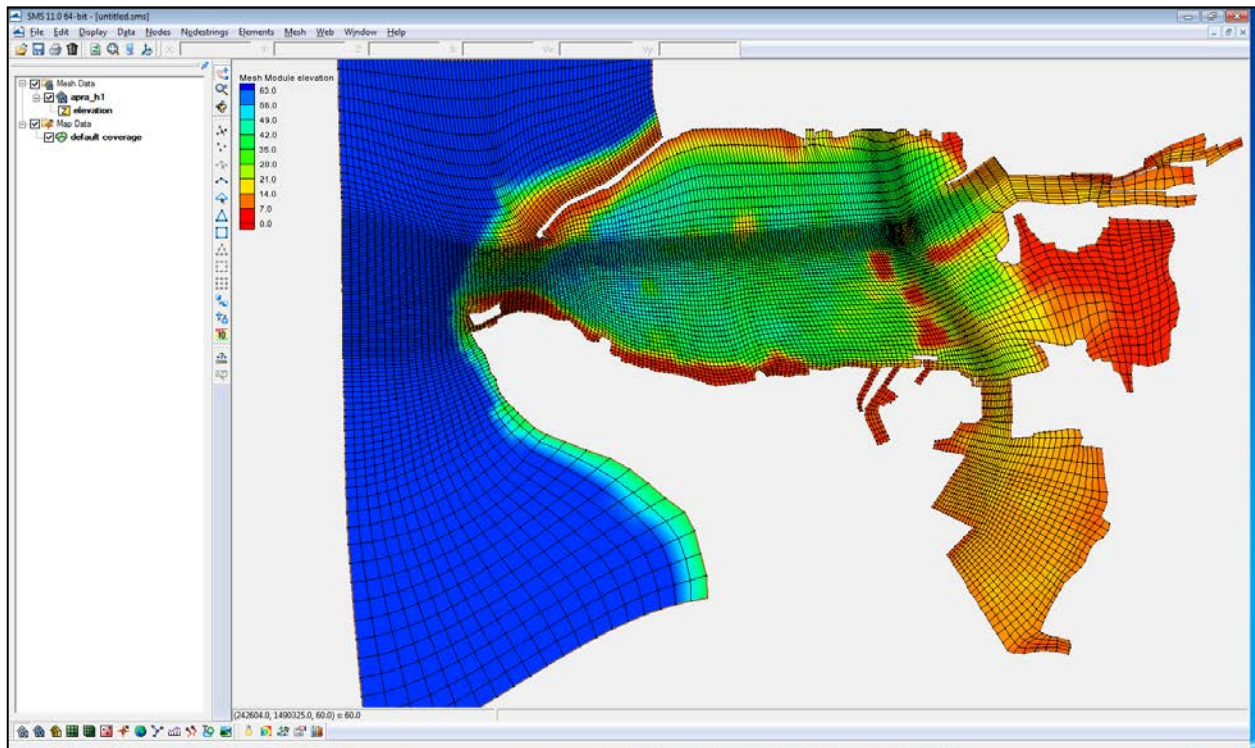

Figure 2-51. Example of Bathymetry Within the SMS 11.0 Modeling Environment

2.34.1.5 The particle paths output by PTM can be used to display qualitative results of the analysis. The SMS interface is used to map the PTM sediment locations and characteristics (such as grain size), so that the origin and path traveled by any (or all) particles can be determined and viewed. These techniques are useful if there are concerns about the sources of sedimentation in sensitive areas (for example, the type and amount of sources arriving at a site, the pathways particles take to reach a site, and the travel times of different parcels arriving at a site). Quantitative results can be determined using the supporting data analysis tools imbedded in the SMS/PTM interface. The methods supported include computation of spatial data sets on a grid, extension of the spatial data sets to three dimension using z-bins, vertical distributions using fence diagrams, and virtual point and polygon gages. For details, see Demirbilek et al (2012a, 2012b). Using these methods, subsequent analysis can be performed:

a. Particle Count: The number of particles in a computational cell within the modeling domain.

b. Accumulation: The depth of particle deposited on the bed in a computational cell within the modeling domain. The volume of particles is calculated using the particle mass and density data set for particles which are inactive (based on the state data set) and in the cell. The volume in each cell is divided by its area to calculate an average depth in the cell. No voids ratio is

included at this time; however, the general Data Calculator in the SMS can be used to modify the resulting data set.

c. Rate of accumulation: The change in accumulation over time.

d. Deposition: The change in depth of particles in a computational cell within the modeling domain during a user-specified focus time.

e. Concentration: The concentration of particles in a computational cell within the modeling domain. The volume of particles is calculated using the particle mass and density data set for particles which are active (based on the state data set) and in the cell. This volume is then divided by the volume of the cell using the specified bathymetry and water surface elevation data sets. The bathymetry and water surface elevation must come from the same geometric object.

f. Exposure: The cumulative exposure in a computational cell within the modeling domain.

g. Dosage: The exposure in a computational cell within the modeling domain during the focus time.

2.34.1.6 The following example, presented by Demirbilek et al. (2012a, 2012b), is a case study used to show both PTM simulations and the supporting data analysis available to users. This case study features the hypothetical region of Todd-istan, which is planning to deepen the entrance channel to the coastal port to increase commerce and trade capacity of Bridges Harbor (Figure 2-52). Deepening will be accomplished by dredging the channel from -45 ft (-13.7 m) to -55 ft (-16.8 m). The channel is 9.3 mi (15,000) long, and the dredging reach (shown in green) is 2953 ft (900 m) long and 492 ft (150 m) wide. A major concern is that dredging will be performed near several environmentally critical areas, including a coral reef (blue), a submerged aquatic vegetation (SAV) region (red), and a fish passage (yellow). There are also competing concerns of maintaining navigation and protecting resources from sediment resuspension. The objective of this case study is to predict exposure due to dredging. A hopper dredge is used for dredging in these simulations. Although dredging occurs only during the first three days, fourteen-day PTM simulations are performed to allow for post dredging transport and deposition. The dredged material removed from the entrance channel is composed of approximately 80% sand and 20% silt and clay. For the simulation, the sediment was separated into two major classes: sands, which represent the coarser material, and fines, which combine the silt and class size materials. Extensive details regarding the data analysis tools in PTM as well as this simulation can be found in Demirbilek et al (2012a, 2012b). This section shows general abilities of the model as opposed to a detailed analysis of the case study.



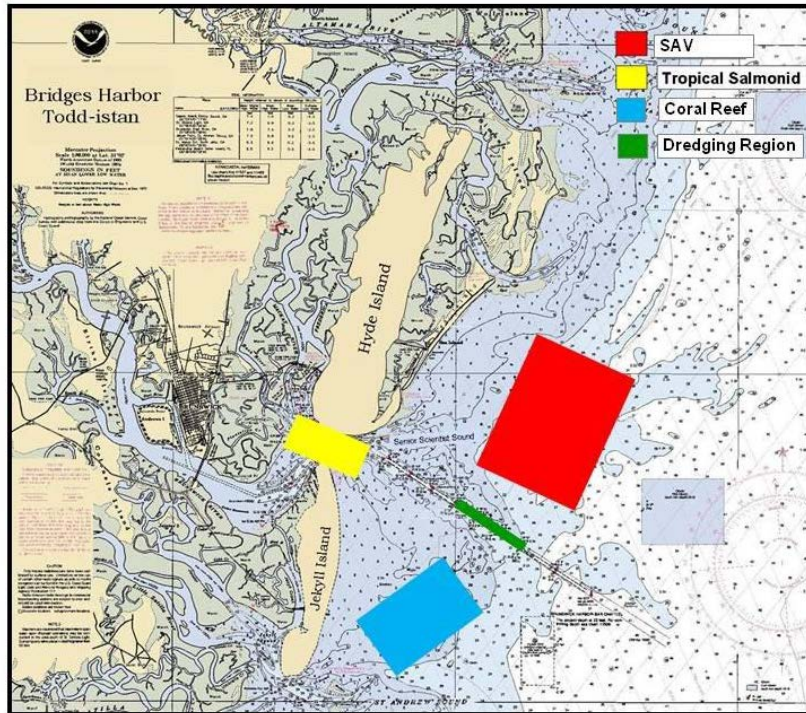

Figure 2-52. Map of Bridges Harbor in the Todd-istan Region with SAV (Red), Tropical Salmoid Passage (Yellow), Coral Reef (Blue), and Dredging Region (Green).

2.34.1.7 Figure 2-53 (a–d) shows a sequence of particles generated by a moving dredge source operating in the channel. Each particle shown in the figure is representative of a mass of sediment. Detailed quantitative information for concentration and deposition is difficult to extract from the visuals and must be determined using the data analysis tools. However, from the particle positions, pathways for sediment transport can be determined. A screening-level assessment of the data shows that sediment is not transported in the direction of the Coral reef area (shown in blue) either during or after dredging. Without further analysis, it is possible to say that for the dredging operation simulated, the coral has little or no exposure to dredging activity and, therefore, it is not at the risk. Figure 2-53 also shows, however, that some sediment is transported within the areas of the salmonid crossing and the submerged aquatic vegetation (SAV).

2.34.1.8 Quantitative information about estimate of concentration is determined using the SMS data analysis tools. The maps and time series of concentration shown here were developed utilizing the Compute Grid Datasets option in the analysis tools. The computational grid region (Figure 2-54) is 3.4 mi (5,500 m) x 8.8 mi (14,100 m). There are 20 grid cells along the shoreline and 50 grid cells in the cross-shore directions, respectively.

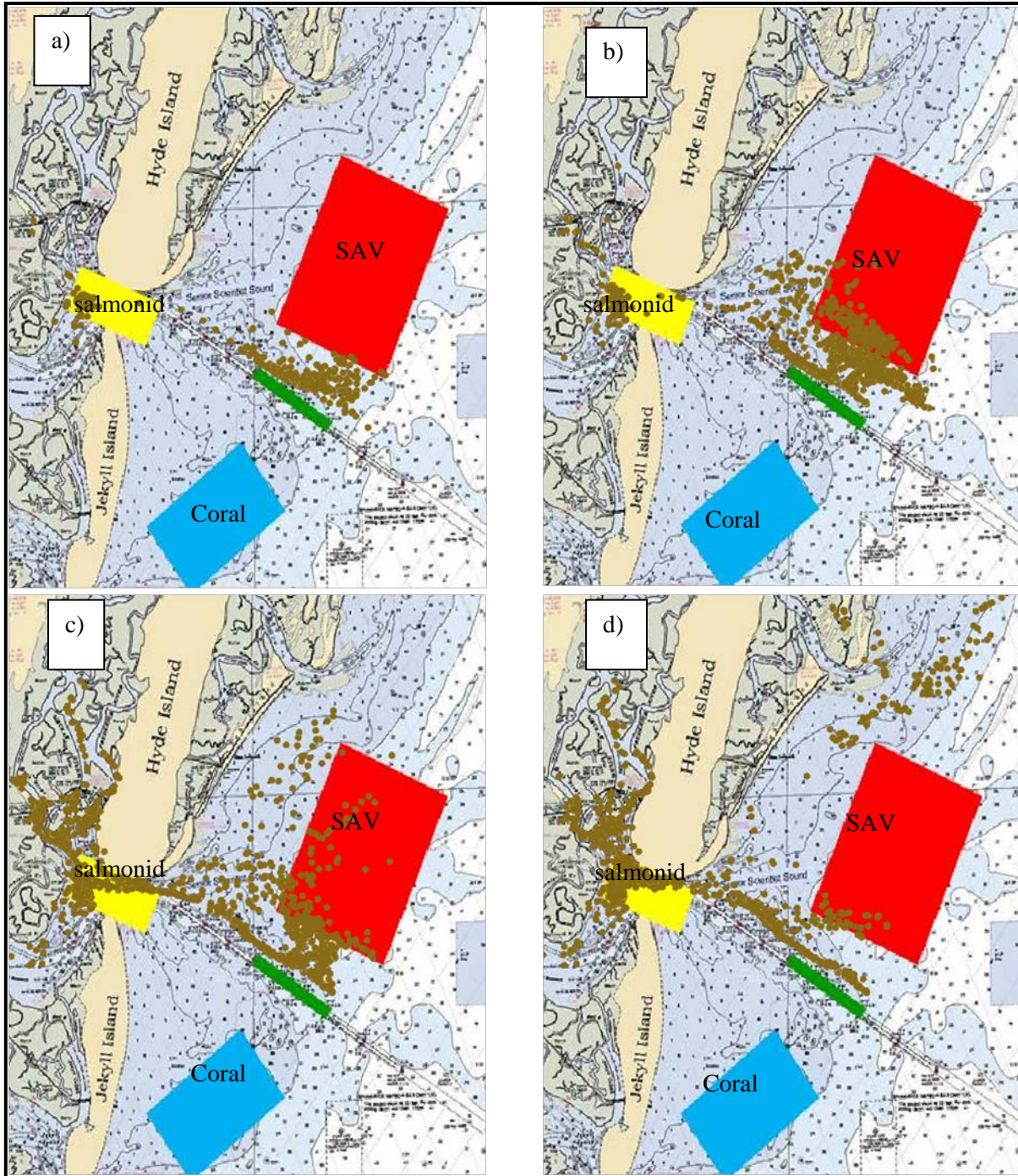

Figure 2-53. Particle Positions Shown for the First, Second, Third, and Seventh Days after Dredging Begins Using a Hopper Dredge with no Overflow



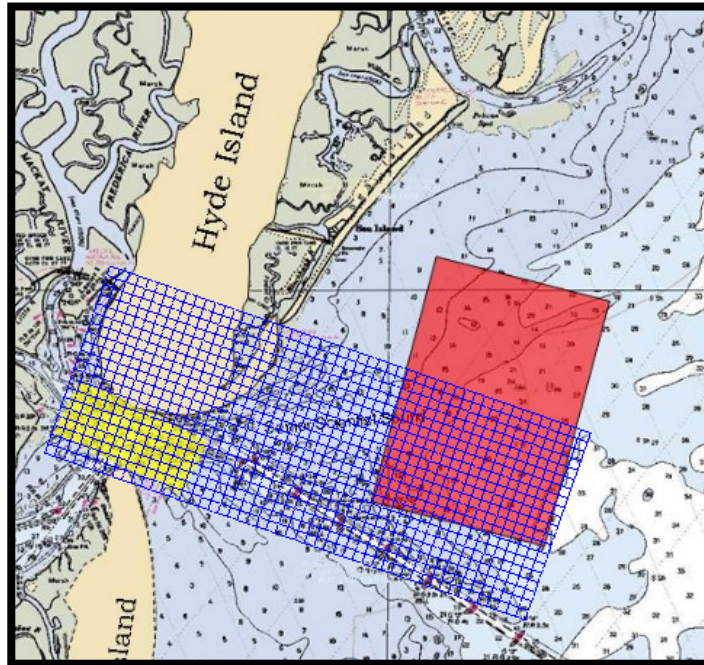

Figure 2-54. Computational Grid for Data Analysis Tools

2.34.1.9 For the tropical salmonid passing, suspended sediment concentration is extremely important. Therefore, within this area (shown in yellow), a data analysis grid was developed (see Figure 2-55). The data analysis region was extended beyond the yellow box to determine the extent of the nonzero values of sediment concentration. The area in question was resolved based on the results shown in the particle position. For these simulations concentration is highly variable both spatially and temporally. Figure 2-55 shows the contours of suspended sediment concentration ( $\text{kg}/\text{m}^3$ ) at Day 3. This snapshot in time was taken during a period when some of the largest concentrations of suspended sediment were visible.

2.34.1.10 In Figure 2-56, a time series of concentration was extracted at one of the points where the largest values of suspended sediment concentration were calculated (or estimated). A number of observations can be made based on these calculations. The time series shows the maximum value of concentration is approximately 35 mg/l. This value occurs at a single instance over the time series, and overall the values of concentration remain less than 25 mg/l. In addition, the largest values are clustered during the first few days of dredging, after which sediment concentrations decrease quickly, suggesting sediments in this area are either rapidly deposited or transported out of the area. After the fifth day of dredging, the values of concentrations remain below 2 mg/l. At the tenth day of dredging, a spike has appeared that represents an amount of sediment that had deposited but was resuspended and passed quickly through the area. The results of suspended sediment concentration can be converted to NTU (nephelometric turbidity units), as well as to the units of light attenuation values, if needed.

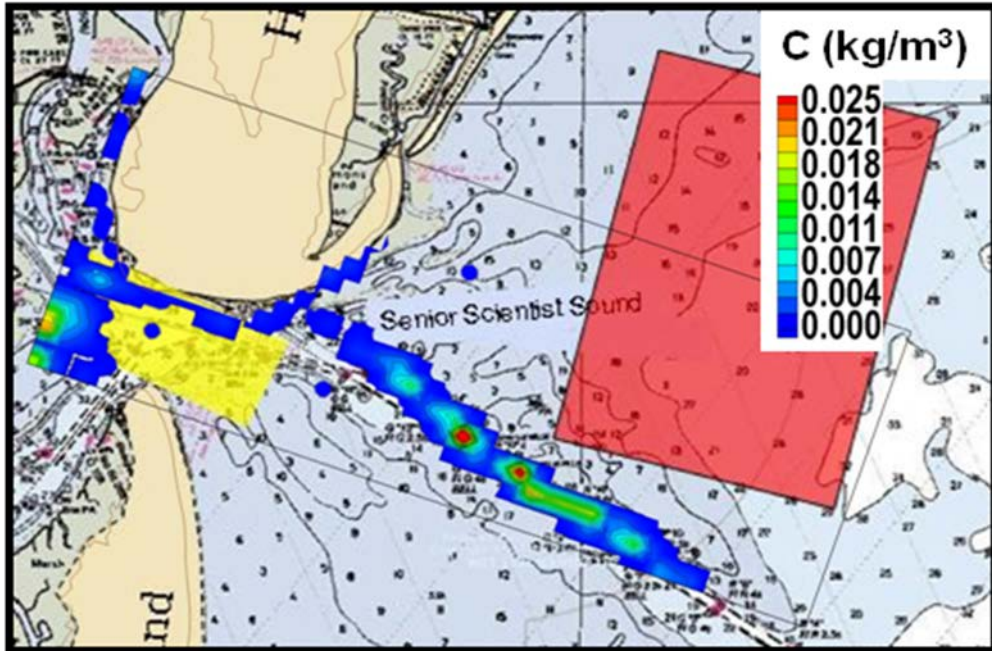

Figure 2-55. Suspended Sediment Concentration Contours Plotted on the Data Analysis Grid During Day 3

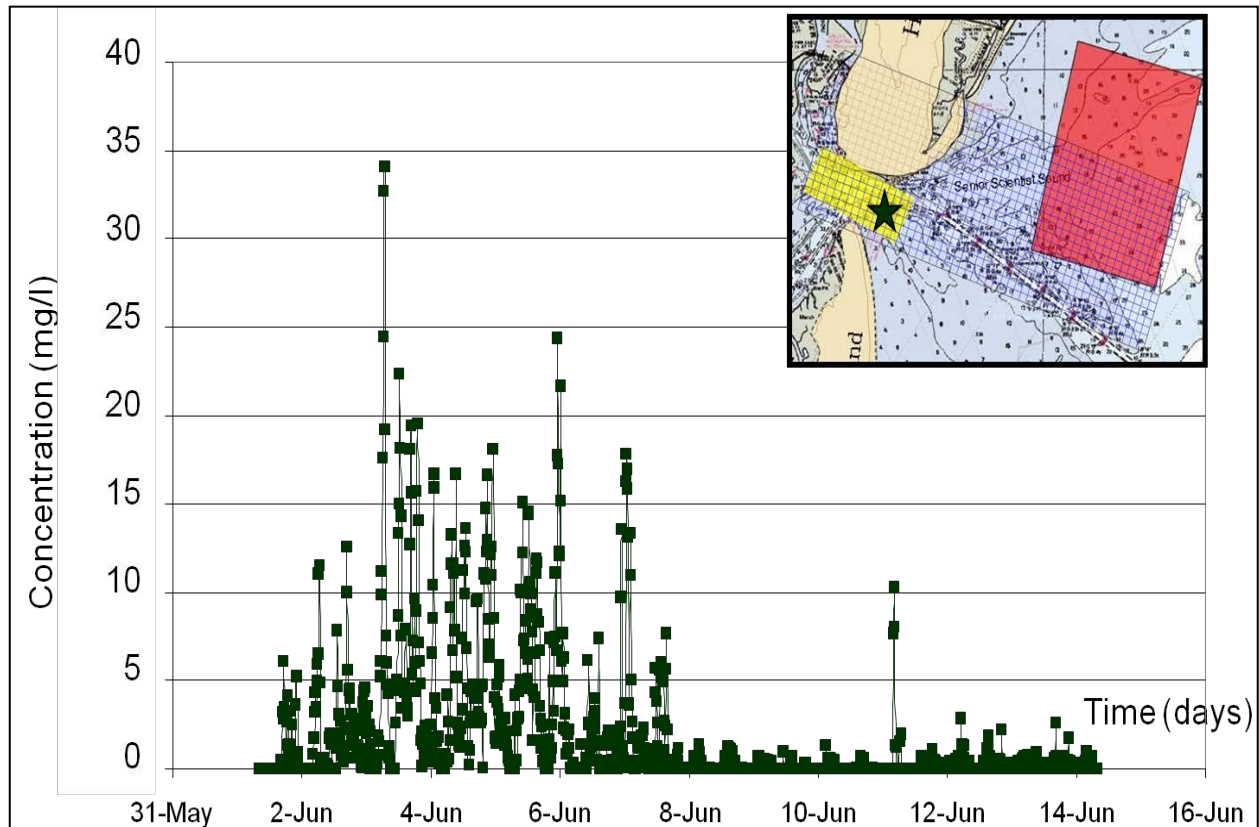

Figure 2-56 Time Series of Concentration at a Point (Marked by the Star in the Upper Schematic).

2.34.1.11 In addition to calculating the total concentration in an area of concern, which is determined by calculating the mass of sediment per volume of water in a grid cell, sometimes an assessment of the vertical distribution of concentrations is important and required. For example, in the case of a fish passage, it is possible that the fish may swim in the upper or lower portion of the water column and, consequently, the risk to the fish depends on the vertical distribution of the sediment concentration. Figure 2-57 shows a vertical cross section at the fish passage (shown in yellow). A black line is drawn in the accompanying schematic to show where the cross section is extracted. In the vertical cross section, the largest concentrations are within the middle of the water column and to the side of the channel.

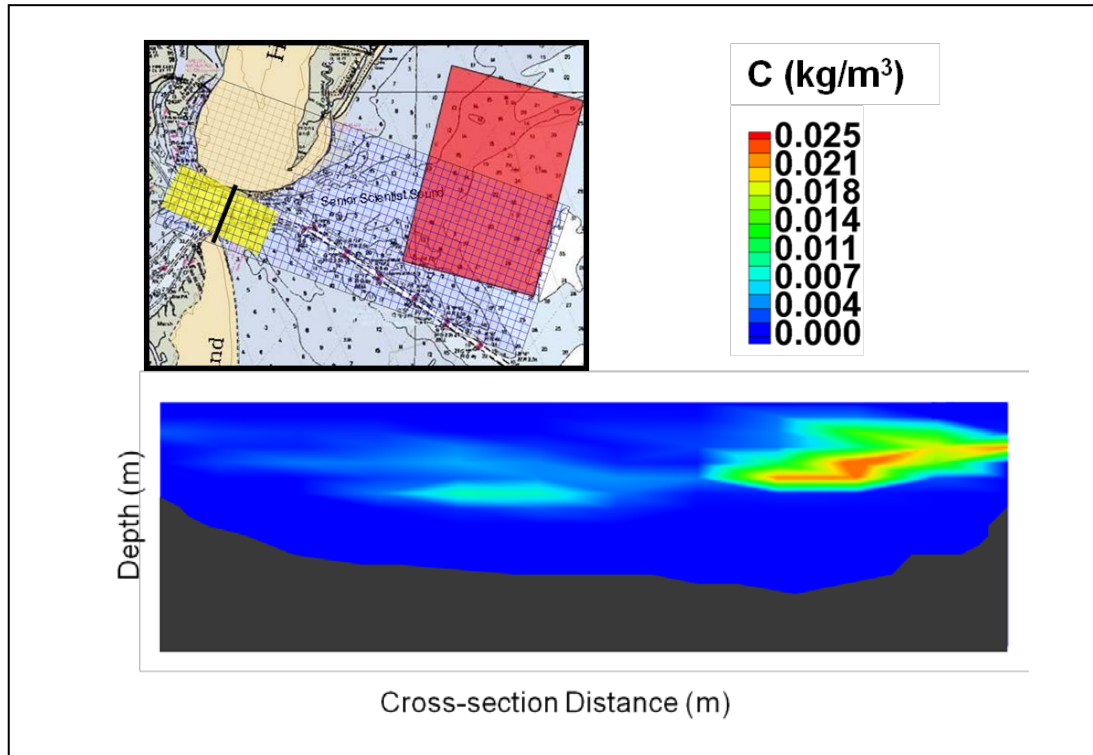

Figure 2-57. Cross Section of Suspended Sediment Concentration Contours (Marked by a Line Shown in the Upper Schematic) During Day 3

2.34.1.12 Additional data analysis of the other engineering parameters of interest as described in 2.34.1.5 (for example, accumulation and dose) can also be performed following the methodology illustrated for the concentration.

## 2.34.2 DREDGE

2.34.2.1 Developed to assist users in making a priori assessments of environmental impacts from proposed dredging operations, DREDGE estimates the sediment mass loss rate, which is the rate that bottom sediments become suspended into the water column as the result of hydraulic and mechanical dredging operations. Assuming the formation of a Gaussian plume, DREDGE then estimates the resulting suspended sediment concentrations for a continuous, uniform operation using site and sediment characteristics to simulate the size and extent of the resulting

suspended sediment plume. DREDGE also estimates total, particulate, and dissolved contaminant concentrations in the water column based upon bulk sediment contaminant concentrations and equilibrium partitioning theory. DREDGE includes the following basic features:

- a. Easy and rapid calculation of dredge plume concentrations resulting from mechanical and hydraulic dredging operations.
- b. Graphical user interface (GUI) for user data input, spreadsheet output, and graphical output.
- c. Relational database system with point-and-click interface for contaminant modeling.
- d. Extensive toxic organic chemical and heavy metal database system plus default Kow values for over 200 chemicals.
- e. Online help system to guide users through the application.
- f. Spreadsheet and graphical output capabilities.
- g. Ability to save all output information in Excel (\*.xls) and text (\*.txt) file formats.
- h. Source strength models for mechanical and hydraulic dredging operations.
- i. 2D analytical transport model to predict the fate of resuspended sediments for a single size class of particles or flocs in the water column.

2.34.2.3 DREDGE is a module of the Automated Dredging and Disposal Alternatives Modeling System (ADDAMS) and is distributed by USACE through the ERDC for use on personal computers. ADDAMS is a design, analysis, and evaluation system for dredged material placement and management consisting of approximately 20 modules to assist in the design and evaluation of various aspects of dredging and dredged material placement operations. More information about other ADDAMS modules is presented in paragraph 2.40.3.3 and Appendix F, "Automated Dredging and Disposal Alternatives Modeling System (ADDAMS)" of this EM. Self-extracting executable models and documents can be downloaded at <http://el.ercd.usace.army.mil/products.cfm?Topic=model&Type=drgmat>.

### 2.35 Biological Considerations.

2.35.1 Biological considerations of dredging include suspended sediments, sedimentation, chemical release, dissolved oxygen reduction, channel blockage, and entrainment. Major categories of biological resources include fishes, shrimps and crabs, shellfishes (for example, oysters and clams), benthic assemblages, a miscellaneous group that includes threatened or endangered species for example, marine mammals and sea turtles), and colonial nesting birds. Appendix B, "Dredging Environmental Considerations," provides summaries of the available technical literature concerning impacts to biological resources from physical and chemical environmental alterations associated with dredging activities.

## 2.36 Environmental Windows.

2.36.1 Environmental windows are temporal constraints placed upon the conduct of dredging or dredged material placement operations to protect biological resources or their habitats from potentially detrimental effects. Environmental windows are based on the simple logic that potential conflicts or detrimental effects can be avoided by preventing dredging or placement during times when biological resources are present or most sensitive to disturbance. The environmental effects of turbidity, suspended sediments, sedimentation, and hydraulic entrainment on aquatic resources are some of the primary concerns leading to environmental windows for dredging projects in coastal, estuarine, and freshwater waterways.

2.36.2 For several decades, State and Federal resource agencies have routinely requested environmental windows. Agencies began requesting environmental windows soon after passage of the NEPA in 1969. Since that time, this practice has become relatively commonplace, affecting a majority of all Federal dredging projects on an annual basis. Under the “Environmental Windows Focus Area” of the DOER Program, research is being conducted to address gaps in the state of knowledge pertaining to windows-related issues.

2.36.3 USACE Districts and Divisions (Table 2-14) were surveyed about various aspects regarding environmental windows. USACE District responses (Table 2-15) confirmed that dredging projects are often delayed and, in rare cases, canceled because of restrictions. A wide variety of issues arises in connection with windows. The following are examples of persistent issues:

- a. Disruption of avian nesting activities and destruction of bird habitat.
- b. Sedimentation and turbidity issues involving fish and shellfish spawning.
- c. Disruption of anadromous fish migrations
- d. Entrainment of juvenile and larval fishes.
- e. Entrainment of threatened and endangered sea turtles as well as disruption of their nesting activities during beach nourishment projects.
- f. Burial and physical removal of protected plants.
- g. Disruption of recreational activities.

The potential detrimental impact to either individual or groups of sport or anadromous fishes was the most commonly cited reason for environmental windows (Table 2-16). Another major topic of concern that was frequently cited involved the protection of threatened and/or endangered species (sea turtles, marine mammals) (Reine, Dickerson, and Clarke 1998).

2.36.4 Reine, Dickerson, and Clarke (1998) report that environmental windows are imposed on many USACE dredging projects in both coastal and inland waterways. Over 83 protected or sensitive species were identified that fall into at least 20 general categories of concern for potentially negative impacts from dredging and placement operations previously



stated. The most widely occurring concern was physical disturbance of habitat and nesting, cited as a technical justification for windows in over three-quarters of all USACE Districts, followed closely by turbidity, suspended sediments, and sedimentation issues. Resources of particular concern that were frequently cited in requests for windows included anadromous fishes (salmon, striped bass, American shad), colonial nesting waterbirds (terns, plovers, pelicans), and endangered species (sturgeon, sea turtles, right whales).

2.36.4.1 Approximately 600 threatened or endangered (Federal and State) and sensitive resource issues have been identified on over 1,000 U.S. Army Corps of Engineers dredging projects to date. The Threatened, Endangered, and Sensitive Species Protection and Management System (<http://el.erdc.usace.army.mil/tessp/intro.cfm>) contains information on those species of concern, which may be viewed collectively at the division, district, project, or state level. At the taxonomic group level, individual species profiles can be explored for such information as Federal and State statutes and State resources, rationales for protection, distribution, habitat, references, and assorted links of interest; USACE information may include dredging concerns, impacts, and documented incidents, environmental windows data, and USACE project locations where the species are known to be of potential concern. Supporting USACE documents, such as District Biological and Environmental Assessments and Biological Opinions, will soon be available for viewing as information is received and uploaded.

2.36.4.2 More detailed information on sea turtles is available at the USACE Sea Turtle Warehouse (<http://el.erdc.usace.army.mil/seaturtles/intro.cfm>) that was created to centralize and archive historical and future data regarding sea turtle impacts from hopper dredging activities for long-term continuity and evaluation of these data. Although the overall impacts to sea turtles from dredging activities is relatively small, the USACE and dredging industry is committed to the continued pursuit of efforts to further reduce dredging impacts on sea turtles.

2.36.5 An evaluation of the economic effects of compliance with restrictions was conducted by Reine, Dickerson, and Clarke (1998). On an annual basis, about 80% of all civil works dredging projects are subject to environmental windows. Estimated annual distribution of environmental windows by dredging method (Federal dredging contracts only) during 1987-1996 is shown in Figure 2-58, and the mean number of Federal dredging contracts by dredging category is presented in Figure 2-59. The results of these analyses, although based on numerous assumptions, indicate that substantial cost increments arise in connection with environmental windows and that substantial cost savings could be derived from resolution of over-restrictive windows. These findings justify new investigations or re-examination of technical issues underlying requests for windows and deserve serious consideration. For all dredging operations, concerted efforts must be maintained to protect valuable natural resources adequately. Many areas of potential research, however, afford an opportunity to remove subjectivity from requests for environmental windows. Rigorous, technically valid studies on environmental windows are needed to evaluate fundamental issues such that windows can be confidently adjusted, through either contraction or expansion, to strike the necessary balance between adequate resource protection and cost-effective dredging practices.

Table 2-14. USACE District Offices Receiving an Environmental Windows Survey (from Reine, Dickerson, and Clarke 1998)

Great Lakes and Ohio River Division (LRD)	Mississippi Valley Division (MVD)
Buffalo District (LRD)	Memphis District (MVM)
Chicago District (LRC)	New Orleans District (MVN)
Detroit District (LRE)	Rock Island District (MVR)
Huntington District (LRH)	St. Louis District (MVS)
Louisville District (LRL)	St. Paul District (MVP)
Nashville District (LRN)	Vicksburg District (MVK)
Pittsburgh District (LRP)	
North Atlantic Division (NAD)	South Atlantic Division (SAD)
Baltimore District (NAB)	Charleston District (SAC)
New England District (NAE)	Jacksonville District (SAJ)
New York District (NAN)	Mobile District (SAM)
Norfolk District (NAO)	Savannah District (SAS)
Philadelphia District (NAP)	Wilmington District (SAW)
Northwestern Division (NWD)	Southwestern Division (SWD)
Kansas City District (NWK)	Fort Worth District (SWF)
Omaha District (NWO)	Galveston District (SWG)
Seattle District (NWS)	Little Rock District (SWL)
Portland District (NWP)	Tulsa District (SWT)
Walla Walla District (NWW)	
South Pacific Division (SPD)	Pacific Ocean Division (POD)
Albuquerque District (SPA)	Alaska District (POA)
Los Angeles District (SPL)	Honolulu District (POH)
Sacramento District (SPK)	
San Francisco District (SPK)	

Table 2-15 – Distribution of Environmental Window Categories by USACE Divisions (from Reine, Dickerson, and Clarke 1998)

Category	NAD	SAD	POD	SPD	NWD	SWD	LRD	MVD	Total
Fish (Entrainment)	X	X	X		X		X	X	6
Fish (Turbidity)	X	X	X		X		X	X	6
Fish (Sedimentation)	X	X			X		X	X	5
Fish (Phy. Disturbance)	X	X	X	X	X		X	X	7
Fish (Dissolved Oxygen)	X	X	X		X		X		5
Fish (Migration)	X	X	X	X	X		X		6
Bird (Nesting)	X	X		X	X	X	X	X	7
Bird (Important Habitat)	X			X	X	X		X	5
Sea Turtles (Pelagic)	X	X	X			X		X	5
Sea Turtles (Nesting)		X							1
Oysters/Shellfish	X				X			X	3
Crab/Lobster	X				X				2
Shrimp		X			X	X			3
Marine Mammals	X	X	X	X					4
Sub. Aqua. Vegetation	X			X					2
Seabeach Amaranth		X							1
Freshwater Mussels							X		1
Hunting/ Recreational	X	X	X				X	X	5
Indiana Bat					X			X	2
Tiger Beetles	X								1
Total	15	13	8	6	12	4	9	10	77

2.36.6 The USACE funded the National Research Council's Transportation Research Board-Marine Board (NRCTRB-MB) to conduct an examination of the application of environmental dredging windows in Federal navigation projects. A workshop was conducted to "explore the decision-making process for establishing environmental windows and to solicit suggestions for improving the process" (NRCTRB-MB 2001).

2.36.7 The statement of task for the project was that the workshop would be used to identify issues and discuss options that could lead to greater consistency in the procedures used by USACE in setting environmental windows. It was anticipated that the workshop would have several panels covering such topics as the wide range of laws and regulations establishing bases for various protection measures; knowns and unknowns about the biological consequences of alternate dredging methodologies; new developments in dredging techniques; better (and worse) examples of decision making for windows in different regions; models of collaborative decision making in other environmental and transportation areas; and tools (such as processes and analytical models) for improving decision making.



Table 2-16. Distribution of Supporting Rationales for Environmental Windows by USACE Divisions (from Reine, Dickerson, and Clarke 1998)

Rationale for Restrictions	USACE Division/District Responses																																																											
	North Atlantic							South Atlantic							Great Lakes/ Ohio River						Mississippi Valley						Northwestern						Southwestern		South Pacific			Pacific Ocean		Total																				
	N	A	N	N	A	N	A	S	S	S	A	A	S	J	M	S	L	L	L	R	R	L	L	R	L	L	R	L	L	L	L	M	M	M	V	V	V	M	M		M	N	N	N	N	W	W	W	P	S	S	S	W	L	S	S	S	S	S	P
Physical Disturbance and Habitat/Nesting Destruction	X	X	X	X	X	X	X	X	X	X	X	X	X	X	X	X	X	X	X	X	X	X	X	X	X	X	X	X	X	X	X	X	X	X	X	X	X	X	X	X	X	X																		
Disruption to nesting activities	X	X	X	X	X	X	X	X	X	X	X	X	X	X	X	X	X	X	X	X	X	X	X	X	X	X	X	X	X	X	X	X	X	X	X	X	X	X	X	X	X	X	X																	
Important bird habitat	X	X	X	X	X	X	X	X	X	X	X	X	X	X	X	X	X	X	X	X	X	X	X	X	X	X	X	X	X	X	X	X	X	X	X	X	X	X	X	X	X	X	X	X																
Fish spawning habitat	X	X	X	X	X	X	X	X	X	X	X	X	X	X	X	X	X	X	X	X	X	X	X	X	X	X	X	X	X	X	X	X	X	X	X	X	X	X	X	X	X	X	X	X	X															
Sea turtle nesting activities																																																												
Burial/removal of aquatic plants	X	X	X	X	X	X	X	X	X	X	X	X	X	X	X	X	X	X	X	X	X	X	X	X	X	X	X	X	X	X	X	X	X	X	X	X	X	X	X	X	X	X	X	X	X	X														
Turbidity and Sedimentation	X	X	X	X	X	X	X	X	X	X	X	X	X	X	X	X	X	X	X	X	X	X	X	X	X	X	X	X	X	X	X	X	X	X	X	X	X	X	X	X	X	X	X	X	X	X	X													
Sedimentation on fish spawning	X	X	X	X	X	X	X	X	X	X	X	X	X	X	X	X	X	X	X	X	X	X	X	X	X	X	X	X	X	X	X	X	X	X	X	X	X	X	X	X	X	X	X	X	X	X	X													
Turbidity on fish spawning	X	X	X	X	X	X	X	X	X	X	X	X	X	X	X	X	X	X	X	X	X	X	X	X	X	X	X	X	X	X	X	X	X	X	X	X	X	X	X	X	X	X	X	X	X	X	X													
Sedimentation or turbidity on shellfish spawning	X	X	X	X	X	X	X	X	X	X	X	X	X	X	X	X	X	X	X	X	X	X	X	X	X	X	X	X	X	X	X	X	X	X	X	X	X	X	X	X	X	X	X	X	X	X	X	X												
Entrainment/Vessel Strike	X	X	X	X	X	X	X	X	X	X	X	X	X	X	X	X	X	X	X	X	X	X	X	X	X	X	X	X	X	X	X	X	X	X	X	X	X	X	X	X	X	X	X	X	X	X	X	X												
Entrainment (fish)																																																												
Entrainment (sea turtles)	X	X	X	X	X	X	X	X	X	X	X	X	X	X	X	X	X	X	X	X	X	X	X	X	X	X	X	X	X	X	X	X	X	X	X	X	X	X	X	X	X	X	X	X	X	X	X	X												
Entrainment (shellfish)	X	X	X	X	X	X	X	X	X	X	X	X	X	X	X	X	X	X	X	X	X	X	X	X	X	X	X	X	X	X	X	X	X	X	X	X	X	X	X	X	X	X	X	X	X	X	X	X	X											
Collisions with marine mammals	X	X	X	X	X	X	X	X	X	X	X	X	X	X	X	X	X	X	X	X	X	X	X	X	X	X	X	X	X	X	X	X	X	X	X	X	X	X	X	X	X	X	X	X	X	X	X	X	X											
Migration (spring/fall/fish)	X	X	X	X	X	X	X	X	X	X	X	X	X	X	X	X	X	X	X	X	X	X	X	X	X	X	X	X	X	X	X	X	X	X	X	X	X	X	X	X	X	X	X	X	X	X	X	X	X											
Water Quality (DO reduction)	X	X	X	X	X	X	X	X	X	X	X	X	X	X	X	X	X	X	X	X	X	X	X	X	X	X	X	X	X	X	X	X	X	X	X	X	X	X	X	X	X	X	X	X	X	X	X	X	X											
Recreational Activities	X	X	X	X	X	X	X	X	X	X	X	X	X	X	X	X	X	X	X	X	X	X	X	X	X	X	X	X	X	X	X	X	X	X	X	X	X	X	X	X	X	X	X	X	X	X	X	X	X											
<b>TOTAL</b>	15	11	12	9	11	11	11	9	13	8	7	2	3	6	3	4	11	7	6	3	7	4	3	7	8	11	7	5	2	7	7	8	9	3	239																									

\* Four additional Districts reported no restrictions. A total of 37 Districts responded.

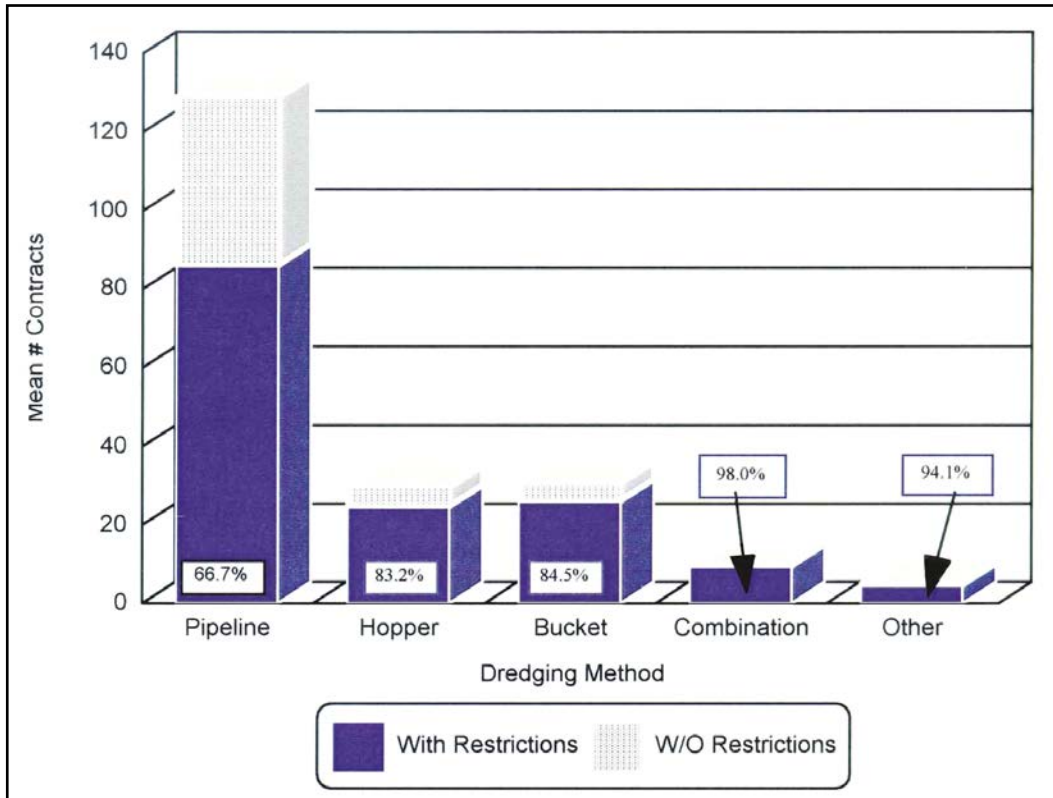

Figure 2-58. Estimated Annual Distribution of Environmental Windows by Dredging Method (FY 1987-1996; Federal Dredging Contracts Only) (from Reine, Dickerson, and Clarke 1998)

2.36.8 Workshop participants were invited to represent a cross section of groups involved in setting windows, including Federal and State resource agency staff, experts in dredging, port officials, environmental groups, and academic experts from a variety of relevant fields. The workshop was designed to ensure opportunities for dialogue and information exchange. The summary provided an identification of the issues raised and opinions expressed both pro and con on these issues. The project committee also provided ideas and suggestions for appropriate follow-up activities, such as additional research, workshops, or a pilot process for setting, managing, and monitoring environmental windows. The results of the examination placed particular emphasis on the development of a pilot process for setting, managing, and monitoring environmental windows that is presented in this report (NRCTRB-MB 2001).

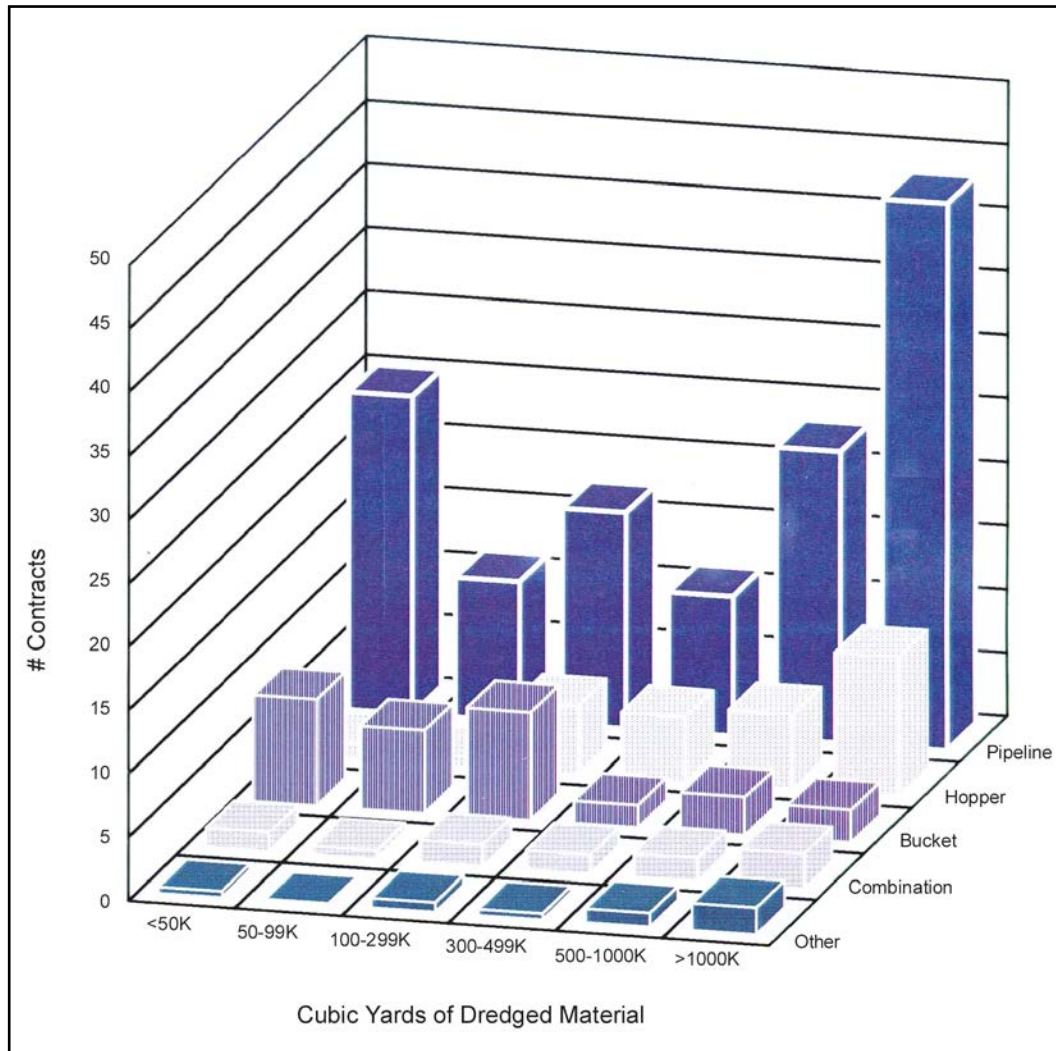

Figure 2-59. Mean Annual Number of Federal Dredging Contracts by Dredging Category (1987-1996) (from Reine, Dickerson, and Clarke 1998)

## Section V Evaluation of Placement Alternatives

### 2.37 Background.

2.37.1 Approximately 194 million cubic yards of sediment must be dredged from waterways and ports each year to improve and maintain the Nation's navigation system and to maintain coastal national defense readiness. Alternatives for the management of dredged material placement from these projects must be carefully evaluated from the standpoint of environmental acceptability, technical feasibility, and economics. ER 1130-2-520 establishes the policy for the operation and maintenance of USACE navigation and dredging projects as well as their related structures and equipment. Dredging must be accomplished in an efficient, cost-effective, and environmentally acceptable manner to improve and maintain the Nation's waterways, making them suitable for navigation and other purposes consistent with Federal laws and regulations.

(Section I of this chapter presents an overview of the USACE project management processes that are used to achieve its navigation and dredging missions.)

2.37.2 Over the past two decades, several factors have developed to create an increasing challenge for the USACE and its partners in operating and maintaining the Nation's harbors, particularly in the area of the management of dredged material:

- a. Substantial and continuous increases in the demands of commerce.
- b. Rapid evolution of shipping practices (containerization and intermodalism).
- c. Increasing environmental awareness and mounting environmental problems affecting coastal and ocean waters.
- d. Tight budgetary constraints.
- e. Heavy population shifts to coastal areas.
- f. Generally increased non-Federal responsibilities in the development and management of navigation projects.

As a result, management of the Nation's harbor system in general, and management of dredged material specifically, has become a controversial problem encompassing all phases of harbor project development and operation, from planning new or larger projects to maintaining existing projects.

2.37.3 Three management alternatives may be considered for dredged material management: open-water placement, confined (diked) placement, and beneficial uses. Open-water disposal, described in detail in Chapter 3, is the placement of dredged material in rivers, lakes, estuaries, or oceans via pipeline or release from hopper dredges or barges. Confined (diked) placement, described in detail in Chapter 4, is placement of dredged material within diked nearshore or upland confined placement facilities via pipeline or other means. Beneficial uses, described in detail in Chapter 5, involve the placement or use of dredged material for some productive purpose.

2.37.4 Beneficial use options should be given full and equal consideration with other alternatives. It is USACE policy to consider fully all aspects of the dredging and placement operations to maximize public benefits. The maximum practicable benefits will be obtained from materials dredged from authorized Federal navigation projects, after taking into consideration economics, engineering, and environmental requirements in accordance with applicable Federal laws and regulations (33 CFR Parts 335-338) (ER 1130-2-520). Generally, beneficial use is an adjunct to or involves either open-water or confined placement in some form, although some beneficial uses involve unconfined placement (for example, wetland creation, island creation, and beach nourishment).

2.37.5 Potential environmental impacts resulting from dredged material placement may be physical, chemical, or biological in nature. Because many of the waterways are located in industrial and urban areas, sediments often contain contaminants from these sources. Unless

properly managed, dredging and disposal of contaminated sediment can adversely affect water quality and aquatic or terrestrial organisms. Sound planning, design, and management of projects are essential if dredged material placement is to be accomplished efficiently with appropriate environmental protection. The selection of a preferred alternative for dredged material management must be based on weighing and balancing a number of considerations, including environmental acceptability, technical feasibility, and economics (USEPA/USACE 2004).

2.37.6 This section presents an overview of the strategy (or Technical Framework) to follow in identifying environmentally acceptable alternatives for the management of dredged material. The Technical Framework is designed to meet the procedural and substantive requirements of the NEPA, CWA, and MPRSA (all described in paragraph 2.4) in a technically consistent manner. Risk management and computer software developed to assist in achieving the objectives of the Technical Framework are also described.

### 2.38 Technical Framework.

2.38.1 USACE and USEPA have developed a consistent Technical Framework for their agencies' personnel to follow in identifying environmentally acceptable alternatives for the management of dredged material (USEPA/USACE 2004). USACE had previously developed a Management Strategy (Francingues et al. 1985), which focused on contaminant testing and controls, for the evaluation of dredged material alternatives, USEPA later initiated development of a similar management strategy, focusing on environmental considerations of placement alternatives. A USACE/USEPA work group was subsequently formed for the purpose of developing the joint Technical Framework, which has been endorsed by both agencies.

2.38.2 The Technical Framework is intended to serve as a consistent roadmap for USACE and USEPA personnel in evaluating the environmental acceptability of dredged material management alternatives. Specifically, its major objective is to provide the following:

- a. A general technical framework for evaluating the environmental acceptability of the full continuum of dredged material management alternatives—open-water placement, confined (diked) placement, and beneficial uses applications.
- b. Additional technical guidance to supplement present implementation and testing manuals for addressing the environmental acceptability of available management options for the discharge of dredged material in both open-water and confined sites.
- c. Enhanced consistency and coordination in USACE and USEPA decision-making in accordance with Federal environmental statutes regulating dredged material.

2.38.3 The Technical Framework is intended to be applicable to all proposed actions involving the management of dredged material. This includes both the new-work construction and navigation project maintenance programs of USACE as well as proposed dredged material discharge actions regulated by USACE. Further, the document addresses the broad range of dredged materials, both clean and contaminated, and the broad array of management alternatives: confined (diked intertidal and upland) placement, open-water (aquatic) placement, and beneficial use applications.

2.38.4 Application of the Technical Framework allows for consistency in decision-making across statutory boundaries and consideration of the full continuum of dredged material discharge options. For example, application of the Technical Framework helps ensure that open-water discharge does not hinder the development and use of other options, such as confined upland sites. The guidance established by the Technical Framework should reduce confusion by both regulators and the regulated community in all future evaluations.

2.38.5 Because the Technical Framework provides national guidance, flexibility is necessary. It should not be followed rigidly; rather, it should be used as a technical guide to evaluate the commonly important factors to be considered in managing dredged material in an environmentally acceptable manner. The Technical Framework is consistent with and incorporates the evaluations conducted under the NEPA, CWA, and MPRSA, and consists of the following broad steps:

- a. Evaluation of dredging project requirements.
- b. Identification of alternatives.
- c. Initial screening of alternatives.
- d. Detailed assessment of alternatives.
- e. Alternative selection.

2.38.6 The following paragraphs describing the overall logic of the Technical Framework are summarized from USEPA/USACE (2004). The overall Technical Framework for developing environmentally acceptable alternatives for the discharge of dredged material is illustrated in Figure 2-60. Chapters 3, 4, and 5 of this EM present more detailed descriptions of the Technical Framework as it applies to each placement alternative.

2.38.6.1 Dredging needs. The need for dredging and the requirements for placement must be established. Dredging location(s) and required volumes to be dredged are among the details gathered at this stage. Within the context of the NEPA, the initial impact assessment for dredging projects relates to the purpose and need for the proposed action in the case of new work or continued viability (purpose, need, and effect of new information on environmental acceptability of the proposal) in the case of existing projects. In contrast, the needs and determinations under the CWA and MPRSA are specifically concerned with a justification of the need for dredged material placement in waters of the United States or ocean waters, respectively. Both types of determinations are addressed in the detailed evaluation of alternatives in the NEPA document and may also be addressed in the project purpose and need statement, compliance with environmental statutes, and other sections of the NEPA document where appropriate. In identifying reasonable alternatives to pursue, environmental impact, cost, and agency policy/regulation, among other factors, may be considered.

2.38.6.2 Determination of availability of alternatives and coverage in existing NEPA document. A review of the project requirements in terms of all reasonable alternatives and the adequate coverage of these alternatives in the existing NEPA document should be made.

Supplemental NEPA documentation is required when significant changes are made in the proposed alternative or when significant new circumstances or information relevant to environmental concerns and bearing on the proposed action or its impacts exist (40 CFR 1502.9[c]). In particular, analyses of CWA/MPRSA alternatives should be reviewed for adequacy. Evaluations conducted for purposes of MPRSA or CWA compliance that indicate potential environmental impacts not previously considered in the selection of an alternative may trigger the need for a supplemental EA or EIS to ensure NEPA compliance.

#### 2.38.6.3 Identification of alternatives.

a. Under the NEPA process, the potential environmental impacts of the discharge of dredged material—including confined (diked), open-water (CWA and/or MPRSA sites), and beneficial uses—must be considered, taking into consideration the nature and needs of the dredging projects and the material to be dredged. The NEPA scoping process encourages the identification of all potential alternatives for dredged material management. Proposed alternatives may consist of any combination of options as warranted by local conditions. Beneficial use of dredged material should be fully considered to ensure that benefits are maximized.

b. When a large number of potential alternatives exist, a reasonable number of examples covering the full spectrum of alternatives must be analyzed and compared in the NEPA document (40 CFR 1502.9[c]). The NEPA document must rigorously address reasonable alternatives that are beyond the capability of the applicant or project proponent or beyond the jurisdiction of the lead agency. Under Council on Environmental Quality regulations, the No-Action (no dredging or continuation of an existing practice) alternative must also be included and retained throughout the NEPA process as a basis for impact comparison. Subsequent evaluations in the framework determine the reasonableness of alternatives identified at this level.

#### 2.38.6.4 Initial screening of alternatives.

a. An initial screening is undertaken to eliminate from further consideration those management alternatives that clearly are not reasonable for the specific project. Reasonable alternatives include those that are practical or feasible from the environmental, technical, and economic standpoint (40 CFR 1502.9[c]) and that use common sense rather than being simply desirable from the standpoint of the project proponent or applicant. The screening should use all available information and should consider factors such as environmental concerns (such as endangered species), cost, technical feasibility (such as site availability and site characteristics that may be incompatible with either the dredged sediment volume or characteristics or the available dredging plant), and legal considerations.

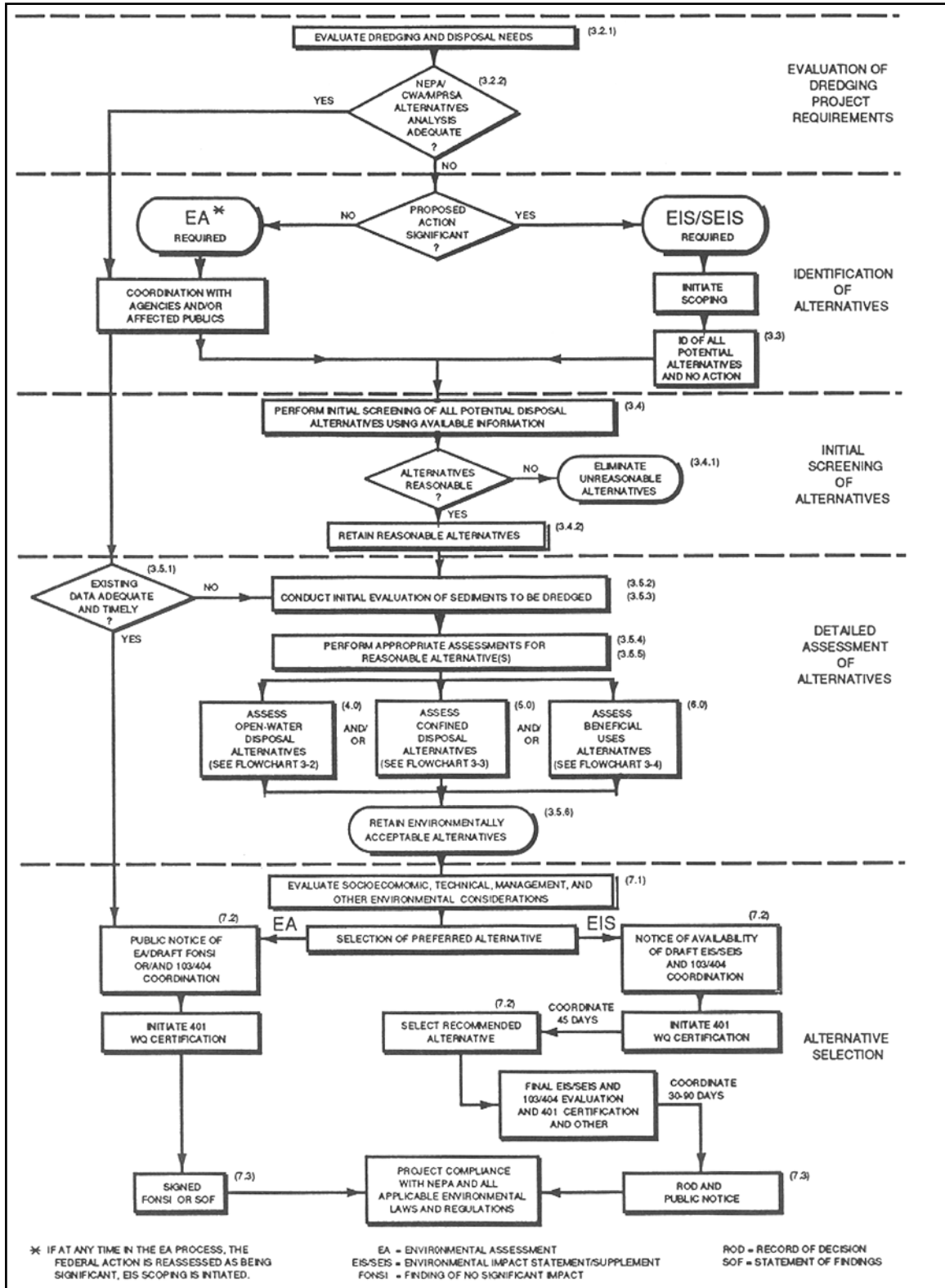

Figure 2-60. Framework for Determining Environmental Acceptability of Dredged Material Disposal Alternatives (from USEPA/USACE 2004)



b. All potential alternatives are evaluated with respect to the availability of the required site(s) and the likelihood that the site can be used. If no existing sites are available, then a determination is made as to whether one or more sites can be designated and/or selected after taking into consideration the reasonableness of doing so for the project in question. For example, the time frame for designating an ocean site under the MPRSA or selecting a CWA open-water site has to be factored into this determination. In those cases where site designation by the USEPA under Section 102 of the MPRSA is required, the NEPA process for both the site designation and the dredging project may be performed jointly or concurrently.

c. Consideration must also be given to design limitations of the project, climatic conditions, dredging equipment availability, physical and chemical aspects of the material to be dredged, local interests, public concerns, and known environmental and economic constraints. The maintenance history of either the project in question or projects in the general area, as well as the experience and knowledge of both the public and resource agencies, provides a basis for the screening process.

2.38.6.5 Eliminate unreasonable alternatives. Although the identification of innovative solutions is encouraged, the nature and needs of the dredging project must be considered in determining the reasonableness of alternatives. Alternatives that require sites that are not available, conflict with other site uses, violate applicable environmental regulations, or are found to be clearly technically or economically infeasible during the screening process are eliminated from further detailed consideration. An alternative may be considered unreasonable, and therefore eliminated from further consideration, if the scoping process has determined it to be unreasonable. The rationale for eliminating alternatives should be clearly documented in the NEPA document. After application of these considerations by the lead agency,<sup>1</sup> those alternatives remaining are scrutinized further for environmental, technical, and economic feasibility.

2.38.6.6 Retain reasonable alternative(s). The evaluation results in an identification of alternatives that are reasonable from an environmental, technical, and economic standpoint. Each remaining option is then carried forward for detailed evaluation via the NEPA/CWA/MPRSA process. The outcome of the detailed evaluation could be that the No-Action alternative is selected or the project not continued.

2.38.6.7 Detailed assessment of alternatives.

a. For purposes of determining environmental acceptability, the detailed assessment of alternatives should include the following:

- (1) Evaluation of the adequacy and timeliness of existing data.
- (2) Evaluation of the physical characteristics of the sediment.
- (3) Initial evaluation of sediment contamination.

---

<sup>1</sup> See guidance in 33 CFR 335-338 and ER 1105-2-100 and NEPA regulations to define lead agency roles and responsibilities.

(4) Appropriate testing and assessments (including required CWA or MPRSA testing).

(5) Evaluation of management options or control measures.

b. Prior to conducting a detailed analysis of alternatives, conducting appropriate coordination among the USACE, the USEPA, and other agencies as appropriate is critical to ensure that any required sampling, testing, and evaluations are satisfactorily conducted.

c. Procedures for conducting the detailed evaluation of alternatives are described in the following paragraphs. Since the procedures for conducting detailed evaluations for open-water disposal, confined disposal, and beneficial use alternatives differ, additional details are presented in Chapters 4, 5, and 6 of USEPA/USACE (2004) and Chapters 3, 4, and 5 of this EM. A wide variety of technical guidance documents is available and is referenced as appropriate in the same publications. Computer-assisted management tools (described in Chapters 2, 3, and 4 of this EM) are also available for conducting many of the detailed assessments that may be required (Schroeder and Palermo 1990).

d. In addition to those considerations for environmental acceptability, a detailed assessment of alternatives includes a comparative review of cost, technical feasibility, and other factors, as appropriate. Even though these additional considerations would normally be assessed as a part of the NEPA process for the project, they are beyond the scope of this EM.

#### 2.38.6.8 Adequacy and timeliness of data.

a. Projects for which all reasonable alternatives have been identified and adequately evaluated still must be assessed in light of CWA or MPRSA evaluation requirements. For those projects in the operations and maintenance or permit renewal categories for which conditions have not changed, a preliminary assessment is made to determine the adequacy and relevance of previous information for the continuance of the dredging/placement activities. If the existing data are sufficient to determine compliance with the CWA or the MPRSA, no additional data are required prior to preparation of the CWA or MPRSA evaluation and coordination of the Public Notice.

b. For new-work Federal navigation projects, new permit applications, or projects for which information is insufficient, additional assessment following the framework as described here and in Chapters 4, 5, and 6 of USEPA/USACE (1992) are required to determine the environmentally acceptable alternative(s).

2.38.6.9 Evaluation of the physical characteristics of sediment. Evaluation of the physical characteristics of sediments proposed for discharge is necessary to determine the potential environmental impacts of placement, the need for additional chemical or biological testing, and the potential beneficial use of the dredged material. If this information has not been gathered during the project evaluation phase, it must be obtained at this point in the framework. The physical characteristics of the dredged material include particle-size distribution, water content or percent solids, specific gravity of solids, and plasticity. The sediment physical characteristics should also be evaluated from the standpoint of compatibility with different kinds of biological communities likely to develop for the placement environments under consideration.

#### 2.38.6.10 Conduct initial evaluation of sediment contamination.

a. The initial screening for contamination is designed to determine, based on available information, if the sediments to be dredged contain any contaminants in forms and concentrations that are likely to cause unacceptable impacts to the environment. During this screening procedure, specific contaminants of concern are identified in a site-specific sediment, so that any subsequent evaluation is focused on the most pertinent contaminants.

b. Initial considerations should include, but are not limited to, the following:

(1) Potential routes by which contaminants could reasonably have been introduced to the sediments.

(2) Data from previous sediment chemical characterization and other tests of the material or other similar material in the vicinity, provided the comparisons are still appropriate.

(3) Probability of contamination from agricultural and urban surface runoff.

(4) Spills of contaminants in the area to be dredged.

(5) Industrial and municipal waste discharges (past and present).

(6) Source and prior use of dredged materials (for example, beach nourishment).

(7) Substantial natural deposits of minerals and other natural substances.

Under the CWA, some materials may be excluded from testing as specified in 40 CFR 230.60. Under the MPRSA, testing must be conducted unless the exclusions in 40 CFR 227.13(b) are met.

c. If the material does not meet the exclusions, contaminants must be addressed with respect to their potential for biological effects and/or release through applicable pathways. If such potential exists, the specific tests and assessments for contaminant pathways described in the following paragraph are required. If ocean disposal alternatives are being considered, particular attention must be given to the presence of certain prohibited materials (40 CFR 227.6) other than as trace contaminants.

#### 2.38.6.11 Perform appropriate testing and assessments

a. Appropriate testing and assessments may be required to determine the physical behavior of the material at the placement site. In addition, testing and assessments for one or more potential contaminant pathways of concern may be required.

b. Physical testing and assessment should focus on both the short-term and long-term physical behavior of the material. For open-water alternatives, these assessments might include an analysis of water column dispersion, mound development, and long-term mound stability or dispersion. For confined alternatives, these assessments might include an analysis of solids retention and storage requirements during placement and long-term consolidation behavior in the

CDF. Guidance for conducting physical testing and assessments is described in Chapters 4, 5, and 6 of USEPA/USACE (2004) and Chapters 3, 4, and 5 of this EM.

c. Any contaminant testing should focus on those contaminant pathways where contaminants may be of environmental concern, and the testing should be tailored to the available placement site. The considerations for identifying contaminant pathways of concern for open-water disposal and confined placement alternatives are discussed in Chapters 4 and 5 of USACE/USEPA (2004) and Chapters 3 and 4 of this EM.

d. For open-water alternatives, contaminant problems may be related to either the water column or benthic environment, and the appropriate testing and assessments include required CWA or MPRSA testing. For confined sites, potential contaminant problems may be either water quality-related (return water effluent, surface runoff, and groundwater leachate), contaminant uptake-related (plant or animal), or air-related (gaseous release).

e. The identification of pathways of concern should be based on the initial evaluation of sediment contamination and on the known characteristics of the placement sites under consideration. One of the following determinations will result for each pathway:

(1) If the initial evaluation of sediment contamination and site characteristics reveals that the material can be excluded from further testing or that adequate data already exist for a given contaminant pathway, then no additional contaminant testing for that pathway is required.

(2) In some cases, past evaluations of sediment contamination and site characteristics may indicate that contaminants would clearly result in unacceptable impacts through a given pathway. In this case, a determination can be made without further testing that management actions or control measures are required for that pathway.

(3) Finally, there may not be sufficient technical information to allow for a factual determination for one or more pathways of concern. The potential impact of specific contaminant pathways must then be evaluated using appropriate testing and evaluations for those pathways.

f. Design of a testing program for the sediment to be dredged depends on the pathways of concern for the alternative being evaluated. Protocols developed to evaluate contaminant pathways of concern consider the unique nature of dredged material and the physicochemical conditions of each placement site under consideration.

g. The testing guidelines that have been developed jointly by USEPA and USACE incorporate a tiered approach and a scientifically based decision process that uses only the level of testing necessary to provide the technical information needed to assess the potential chemical and biological effects of the proposed ocean disposal of dredged material (USEPA/USACE 1991). A companion document addresses discharges of dredged material under the CWA (USEPA/USACE 1998). Other relevant guidance is available (Francingues et al. 1985; Lee et al. 1991). Testing and evaluations for specific contaminant pathways for open-water and confined-placement alternatives are discussed in more detail in Chapters 4 and 5 of USEPA/USACE (1991) and Chapters 3 and 4 of this EM.

#### 2.38.6.12 Evaluation of management actions or control measures to minimize impacts.

a. In cases where the results of tests or assessments indicate that the MPRSA impact criteria or CWA guidelines for a given pathway will not be met, management actions should be considered to reduce potential environmental impacts (33 CFR 335-338; Francingues et al. 1985; Lee et al. 1991; Cullinane et al. 1986). Management actions or control measures may be considered for physical and/or contaminant impacts.

b. Possible controls for open-water alternatives include operational modifications, use of submerged discharge, treatment, lateral containment, and capping or contained aquatic disposal. Possible controls for confined (diked) placement include operational modifications, treatment, and various site controls (for example, covers and liners). Descriptions of management and control measures for open-water and confined alternatives and procedures for assessing site-specific effectiveness are given in Chapters 4 and 5 of USEPA/USACE (2004) and Chapters 3 and 4 of this EM.

c. The effectiveness of management controls for contaminated sediments must be carefully considered since no placement option and/or management action or control measure is without risk. When considering the use of management actions or controls, the following factors must be considered:

(1) Probability of success of a given control.

(2) Monitoring required to confirm the effectiveness of the control.

(3) Duration and significance of adverse effects should a given control prove to be ineffective.

(4) Availability, feasibility, timeliness, and cost of additional management actions should they be required.

2.38.6.13 Retention of environmentally acceptable alternatives. With the completion of detailed testing and assessments and the consideration of management and control measures for the respective alternatives, a determination of environmental acceptability is made. This determination must ensure that all applicable standards or criteria are met. If control measures were considered, a determination of the effectiveness of the control measure in meeting the standards or criteria must be made. If all standards or criteria are met, the alternative can be considered environmentally acceptable. At this point in the framework, socioeconomic, technical, and other applicable environmental considerations must be evaluated prior to the selection of a management alternative.

#### 2.38.6.14 Alternative selection.

a. The detailed assessment of alternatives may result in one or more alternatives that are environmentally acceptable. Weighing and balancing of all environmental, technical, and economic factors must be conducted before the selection of the preferred/proposed alternative by the lead agency. The process for conducting this weighing and balancing is described in the implementing regulations of the NEPA/CWA/MPRSA. The coordination and documentation

process includes draft and final NEPA/CWA/MPRSA documents, Public Notices, and a final-decision document, which addresses comments on the draft NEPA/CWA/MPRSA documents.

b. The selection of a preferred/proposed alternative is based on environmental acceptability, technical feasibility, costs, and other factors, as appropriate. A detailed discussion of factors in decision making other than environmental acceptability is beyond the scope of this EM. However, considerations in alternative selection, including a description of the procedures to be followed with respect to the NEPA, CWA, and MPRSA, are discussed in Chapter 7 of USEPA/USACE (2004). Once an alternative has been selected, proper coordination and documentation have been completed, and a final-decision document has been issued, the project should be in compliance with the NEPA and all applicable environmental laws and regulations.

### 2.39 Risk Analysis.

2.39.1 Scientific advancements have made possible the collection of large amounts of complex information regarding the environmental aspects of dredging and dredged material placement. Environmental risk assessment provides a stepwise framework for the integration of complex information to yield quantifiable estimates of risk including uncertainty. The use of risk assessment can supplement the analytical options currently available to dredged material managers by building on the existing technical framework (USEPA/USACE 2004) and the existing tiered approaches (USEPA/USACE 1991, 1998), especially in those cases where more commonly applied analytical approaches do not provide sufficient information upon which to base decisions about dredged material management.

2.39.2 There are numerous program-specific documents that describe the formal components of a risk assessment and detail how to conduct one within the constraints of the program. The dredged material manager should recognize that risk assessments include several general components, based on a USEPA framework (USEPA/USACE 2004) and published guidelines (EM 200-1-4, USEPA 1998). The risk assessment process has four general components.

2.39.2.1 Hazard Identification/Problem Formulation. Hazard Identification is the process of determining whether exposure to a contaminant can cause an increase in the incidence of a particular human health (for example, cancer or birth defect) or ecological (for example, reproductive or lethal) effect. In ecological risk assessment, the selection of receptors begins in this section, but it is a process that continues into the Exposure Assessment.

2.39.2.2 Exposure Assessment. An Exposure Assessment estimates the magnitude of actual and/or potential human or ecological exposure to a contaminant of concern, the frequency and duration of exposure, and the pathways of exposure for human and ecological receptors. This is the major step in the development of scenarios, and the decisions made during the Exposure Assessment are critical to the ultimate estimate of risk. To address the concerns of the stakeholders, it is important that this aspect of scenario development be a cooperative effort early in the risk assessment process. An important component of Exposure Assessment is the selection of human and ecological receptors. To a large extent, these drive the development of exposure pathways.

2.39.2.3 Toxicity Assessment/Effects Assessment. The Toxicity Assessment summarizes and weighs available evidence regarding the potential for contaminants to cause adverse effects in exposed individuals and to provide, where possible, an estimate of the relationship between the extent of exposure to a contaminant and the increased likelihood and/or severity of adverse effects. Current guidance for Ecological Risk Assessment often refers to a Toxicity Assessment as an Effects Assessment.

2.39.2.4 Risk Characterization. The Risk Characterization summarizes and integrates the Exposure Assessment and Toxicity Assessment into a quantitative and qualitative expression of risk. In a human health risk assessment, the Risk Characterization does the following:

- a. Characterizes carcinogenic effects by estimating probabilities that an individual will develop cancer over a lifetime of exposure based on projected intakes from a given scenario and the information summarized in the Toxicity Assessment.
- b. Characterizes noncarcinogenic effects by comparing calculated intakes of substances, based on specific exposure scenarios, to acceptable doses.

2.39.3 Generally in an Ecological Risk Assessment, Risk Characterization evaluates risk by comparing a concentration, dose, or body burden known to produce an effect with a corresponding measurement or projection of exposure made in the Exposure Assessment (toxicity quotient method). The risk assessor may consider the toxicity quotient with other sources of information (biological conditions at the site, information from reference areas) to form a professional opinion regarding potential risk in a weight of evidence approach.

2.39.4 The Risk Characterization should also address uncertainty in the analysis of human health and ecological risk. Risk assessments do not generally provide fully probabilistic estimations of risk. Therefore, highly quantitative statistical uncertainty analyses are not common. The USEPA Office of Emergency and Remedial Response (OERR) (1989) emphasizes the importance of identifying the key site-related variables and assumptions that contribute most to the uncertainty.

2.39.5 At most sites, risk assessment addresses two general types of risk—ecological risk and human health risk. Ecological risk assessment focuses on potential risk to nonhuman biota likely to occur at a placement site. Human-health risk assessment focuses on carcinogenic and noncarcinogenic risk to humans from potential exposure. A major difference between the two is that a human health risk assessment addresses potential effects to one type of receptor, human beings, while ecological risk assessment can address risk to several receptors, chosen to represent the ecosystem associated with the dredged material placement site.

2.39.6 These two types of risk assessment address the fate and transport of contaminants in similar, if not identical, manners. Those physical and chemical processes that drive the distribution of contaminants do not change between the two types of risk assessment. The two are linked in that the estimates of contaminant uptake by biota (evaluated in the ecological risk assessment) may result in exposure to humans if people eat that organism. Clearly, the feeding habits of a commercial species, an ecological characteristic, to a large extent determine whether that species can pass a contaminant on to a human. This is the point where ecological risk and

human health risk are most closely linked. They diverge in the discussion of toxicological processes and how these processes relate to potential effects.

2.39.7 Cura et al. (1999) provides detailed guidance for developing site-specific risk assessments for dredged material management sites in aquatic environments. It demonstrates the development of conceptual models that show the likely sources of risk, transport pathways, types of receptors, assessment end points, and physical or chemical relationships among them for ecological and human health exposures. Cura et al. (1999) illustrates the use of risk assessment with a continuous case study and reviews available Federal, State, and regional guidance, and methods used by human health and ecological risk assessors. The appendices include a review of the content and availability of various text and online information important in conducting risk assessments; a description of food chain models useful in risk assessment; summaries of the toxicology of likely contaminants of concern at dredged material management sites; and an approach to weight of evidence.

2.39.8 The objective of the Dredging Operations and Environmental Research (DOER) Risk focus area (<http://el.erdc.usace.army.mil/dots/doer/rm.html>) is to develop quantitative methods and tools to support risk analysis of the environmental and economic benefits/costs associated with the full range of available dredged material management options. The use of these risk analysis approaches facilitates quantitative, comparison-based decision making when selecting management options for navigation dredging projects. The products of this focus area provide defensible, quantitative support for risk-based decision making to manage contaminated sediments while minimizing operational and environmental costs. Additional benefits of implementing these products are reduced controversy, conflict, and project delays while simultaneously increasing the credibility of the USACE with other agencies that embrace the risk management process.

#### 2.40 Dredging and Dredged Material Management Software Tools.

2.40.1 Federal regulations require that dredging and dredged material placement be done at minimum cost while being consistent with sound engineering principles and proper concern for the environment. Over the past two-and-a-half decades, knowledge of the environmental impacts associated with dredging and dredged material placement has increased. The emphasis has shifted from one that was most concerned with low cost to a much more balanced view with environmental concerns playing an increasingly larger role in dredging project management. In addition, the awareness that dredged material should be considered a resource that can be used beneficially in an increasing number of ways has greatly influenced dredging project management.

2.40.2 For these reasons, managing dredging projects is now more complex than in the past. In addition to the ever-increasing number of regulations and statutes that govern dredging and dredged material placement, many State resource agencies and environmental groups now subject dredging projects to greater scrutiny. To improve or maintain its credibility, the USACE must be able to conclusively demonstrate that dredging projects are being effectively managed. Management of dredging and dredged material placement has a number of facets. Dredging project management provides answers to the following questions:



- a. What is being dredged?
- b. How much is being dredged?
- c. When will dredging take place?
- d. Where did the dredged material come from?
- e. Where will the dredged material be placed?
- f. How will the material be dredged and placed?
- g. What will happen to the environment at the dredging site? At the placement site?
- h. Was the material dredged correctly? Placed correctly?

2.40.3 Three examples of software packages designed to assist in dredged material planning, design, and management aspects are the National Dredging Quality Management (DQM) Program, the Enterprise Geographic Information System (eGIS) and Corps of Engineers Dredge (CE-Dredge), and the Automated Dredging and Disposal Alternatives Modeling System (ADDAMS). DQM is introduced in paragraph 2.31.5.

2.40.3.1 Enterprise Geographic Information System (eGIS) and Corps of Engineers Dredge (CE-Dredge)

a. A Geographic Information System (GIS) is a collection of computer hardware, software, and geographic data for capturing, managing, manipulating, analyzing, and displaying all forms of geographically referenced information. Enterprise GIS (eGIS) is defined as the integration of geospatial technology infrastructure to deliver spatial information products, services, and standard data sets to all business elements and processes of the organization. The concept of eGIS is taking a complete organizational approach to sharing, using, and managing spatial information. Implementation of the eGIS concept is quickly expanding across the USACE.

b. CE-Dredge (<http://ce-dredge.usace.army.mil/>), an architecture developed by the USACE that utilizes spatial data standards (SDS), geodatabase development, and desktop and web-based applications, serves as a subset of the USACE eGIS system. It provides a framework to assist in the development and management of the Navigation and Coastal Data Bank (NCDB) that serves navigation, dredging, and coastal data. CE-Dredge was designed as a data management solution to provide baseline information for effective planning and management of regional and local dredging operations, and it is a repository for all types of navigation-, dredging-, and coastal-related information including, but not limited to, channel definitions or framework, dredging and placement areas, dredge histories, geotechnical and sediment information, surveys, sediment budgets, imagery, and National Oceanic and Atmospheric Administration (NOAA) charts. CE-Dredge includes web-based management tools used to support operational dredging. Figures 2-61 through 2-63 show the CE-Dredge Dredging Manager application, which is used to visualize navigation channels and placement areas, and provides tools for managing placement areas, beneficial use sites, and dredging contracts. Promoting a standard for this type of data

allows USACE to effectively collaborate with other federal partners. Though data is physically distributed throughout all of the districts, USACE can deliver data that is in a uniform format.

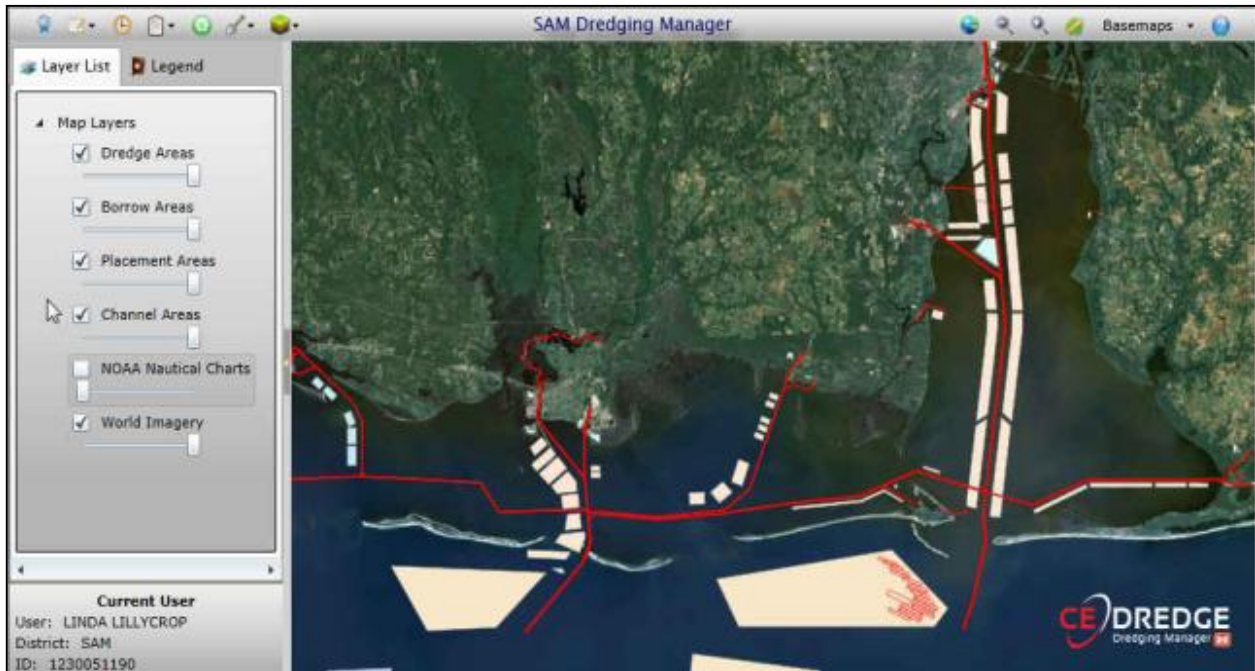

Figure 2-61. CE-Dredge Dredging Manager Navigation Channels and Cisposal Areas Visualization

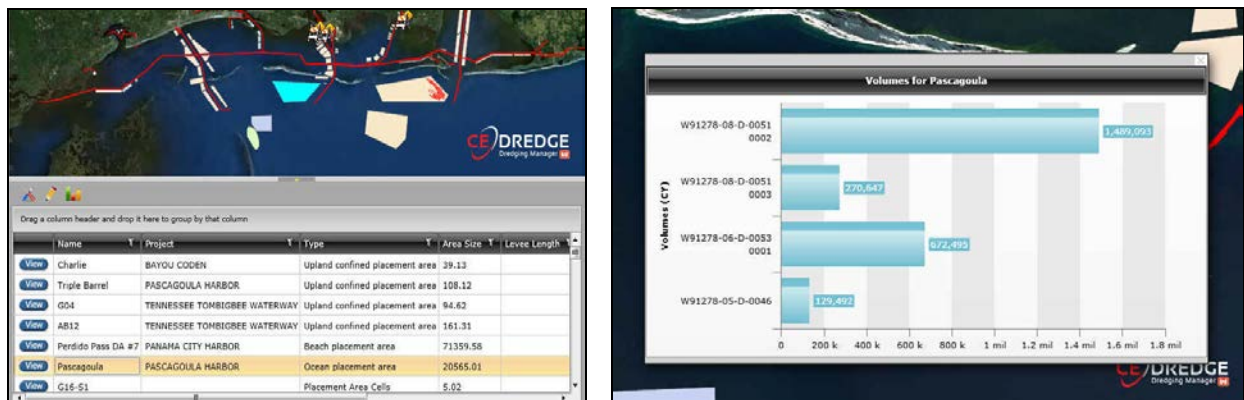

Figure 2-62. CE-Dredge Placement Area and Beneficial User Management

### 2.40.3.2 Dredging Quality Management (DQM) to Monitor Ocean Disposal Compliance

a. The DQM suite of tools allows authorized USACE users to monitor the ocean disposal activities of dredging operations, run initial quality control queries, and produce reports to keep the U.S. Environmental Protection Agency (USEPA) informed of dredge disposal activities. These tools use a web-based interface to interact with the DQM and geospatial data sets. For Ocean Disposal Monitoring (ODM), a subset of DQM tools—the DQM Data Viewer and the DQM Cumulative Disposal Plot—is used.



Figure 2-63. CE-Dredge Dredging Contracts Management

b. The DQM Data Viewer provides the initial daily quality control. The USACE Ocean Disposal Site Manager uses the Data Viewer to verify the dredging and disposal activities on-line. This tool allows the user to interact with the data anywhere via his/her USACE laptop and a viable Internet connection. The visual map tracks the position of the vessel as it operates. The map also includes the option to add geospatial layers such as basemaps, the Channel Framework, National Oceanographic and Atmospheric Administration (NOAA) Inland Electronic Navigation Charts (IENCs), and disposal boundary areas. The zoom in/out, pan, and rotate features allow the user to customize the map view. Selecting individual points on the map displays their associated parameters, collected by the DQM system, within the view. The graphing tool allows the user to graph select data parameters versus time. Using the map in conjunction with the graphing tool gives the site manager the ability to trace the vessel position on the map and simultaneously have a visual of the data value of every parameter collected at that point in time, as demonstrated in Figure 2-64 (coastal hopper dredge project) and Figure 2-65 (riverine hopper dredge project).

c. The Cumulative Disposal Plot (Figures 2-66 and 2-67) is another web-based DQM tool available to the site manager. It gives the user the ability to view and quickly create a report of the disposal activity for a specific period of time. This report includes the start and end locations of the disposal event for the specific vessel. The application automatically zooms to the boundaries of the disposal site and shows all dumps occurring within the requested time period. It also displays any dumps occurring outside the designated disposal area.

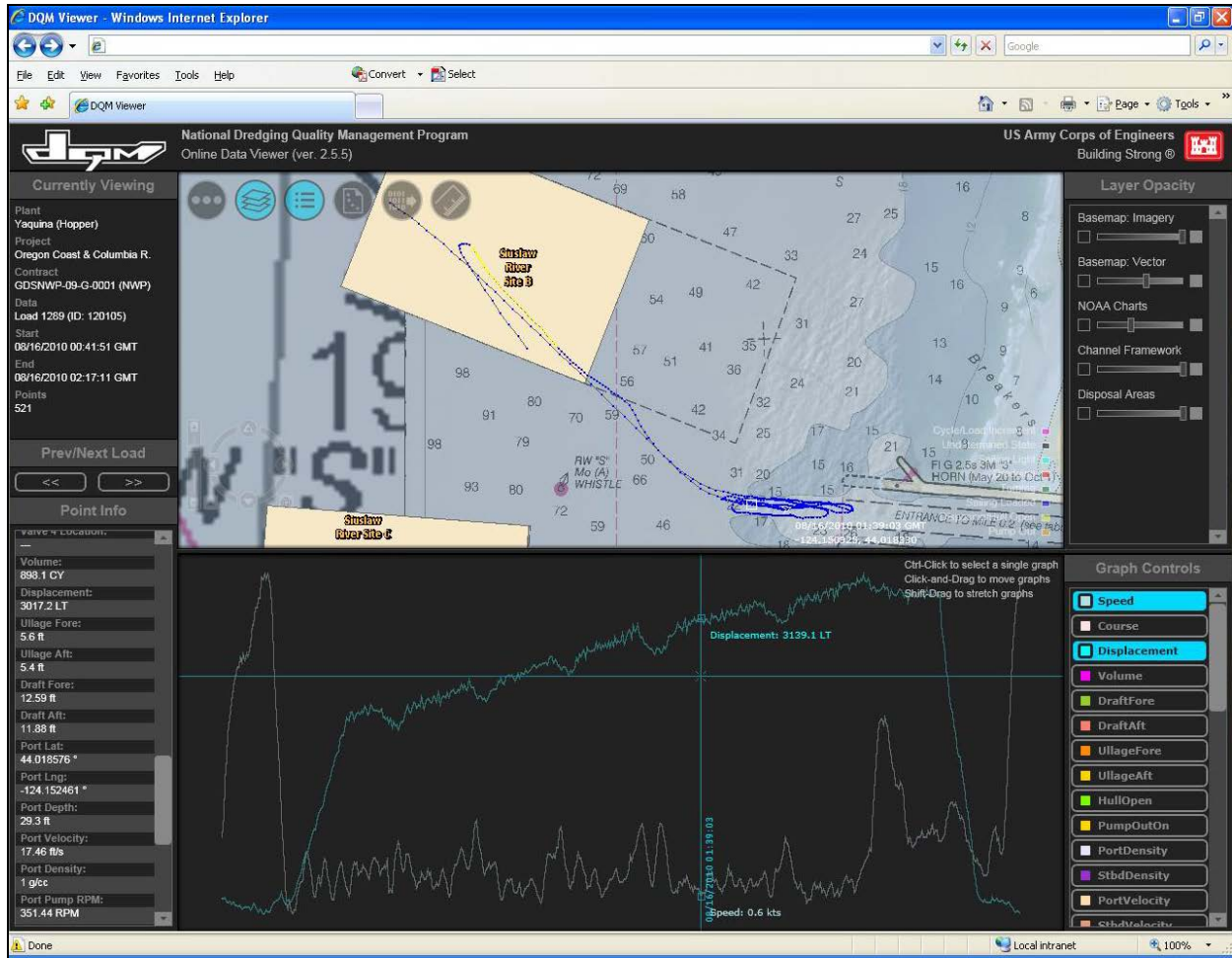

Figure 2-64. DQM Data Viewer Screenshot of a Coastal Hopper Dredge Project



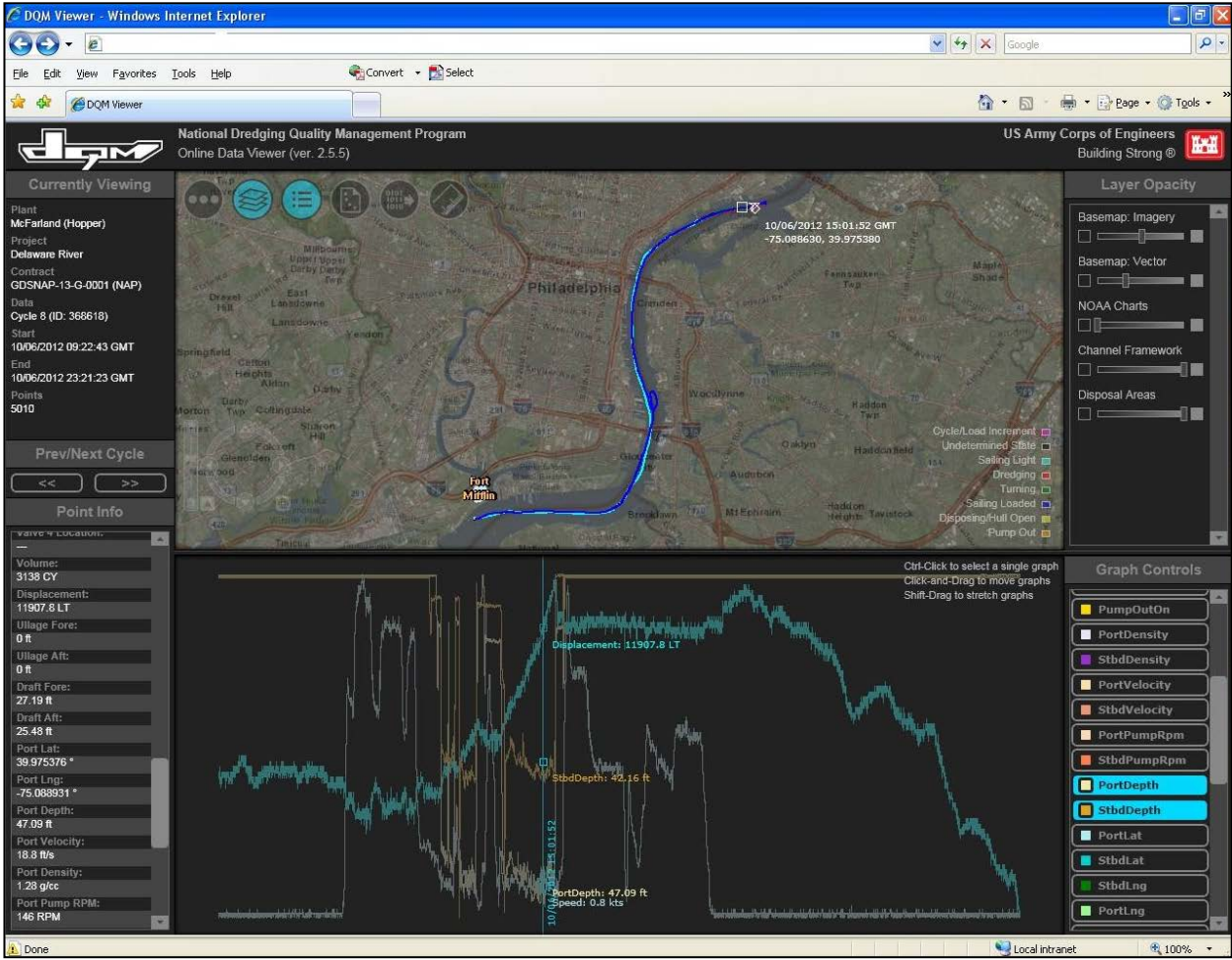

Figure 2-65. DQM Data Viewer Screenshot of a Riverine Hopper Dredge Project

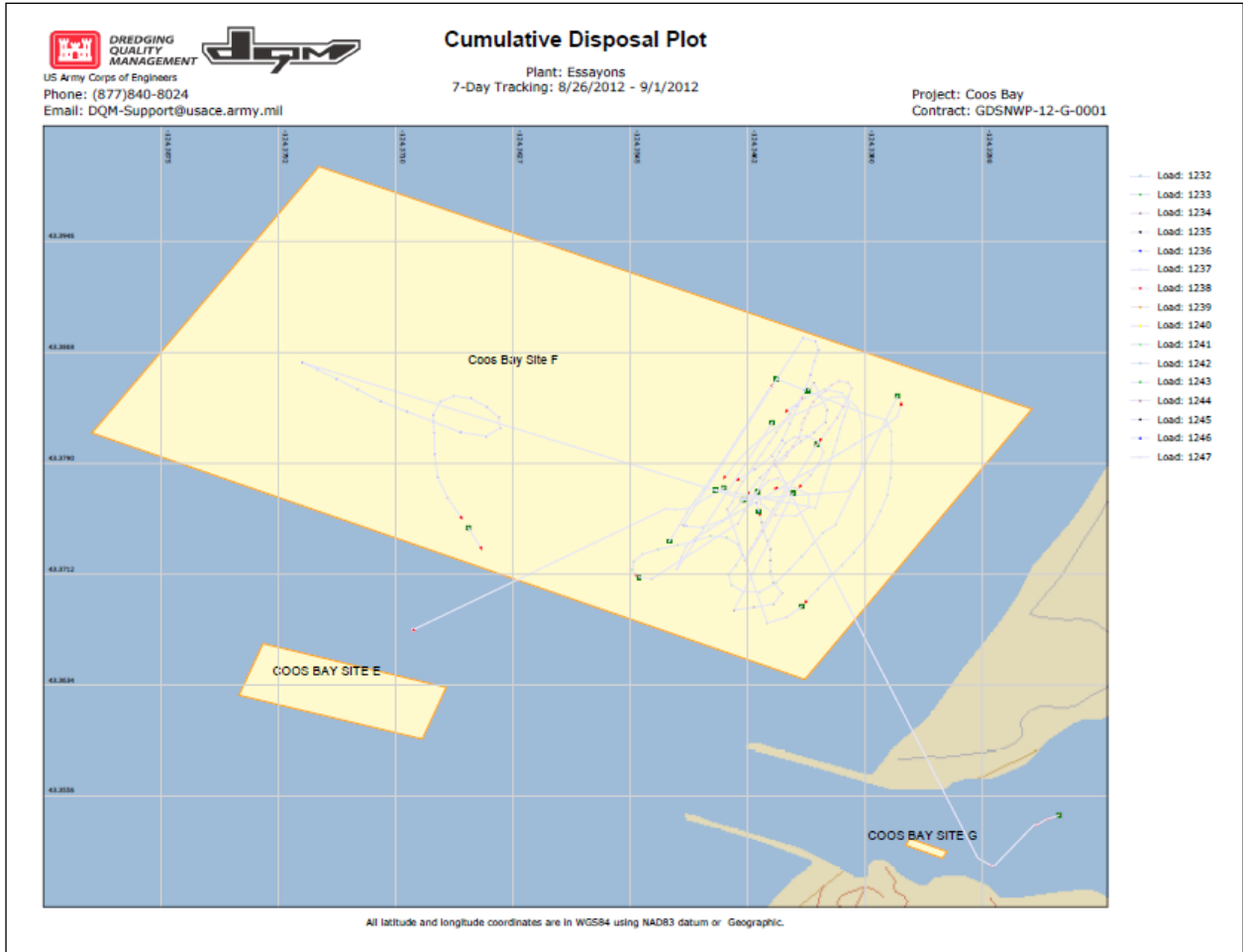

Figure 2-66. Screenshot of a DQM Cumulative Disposal Plot (1)

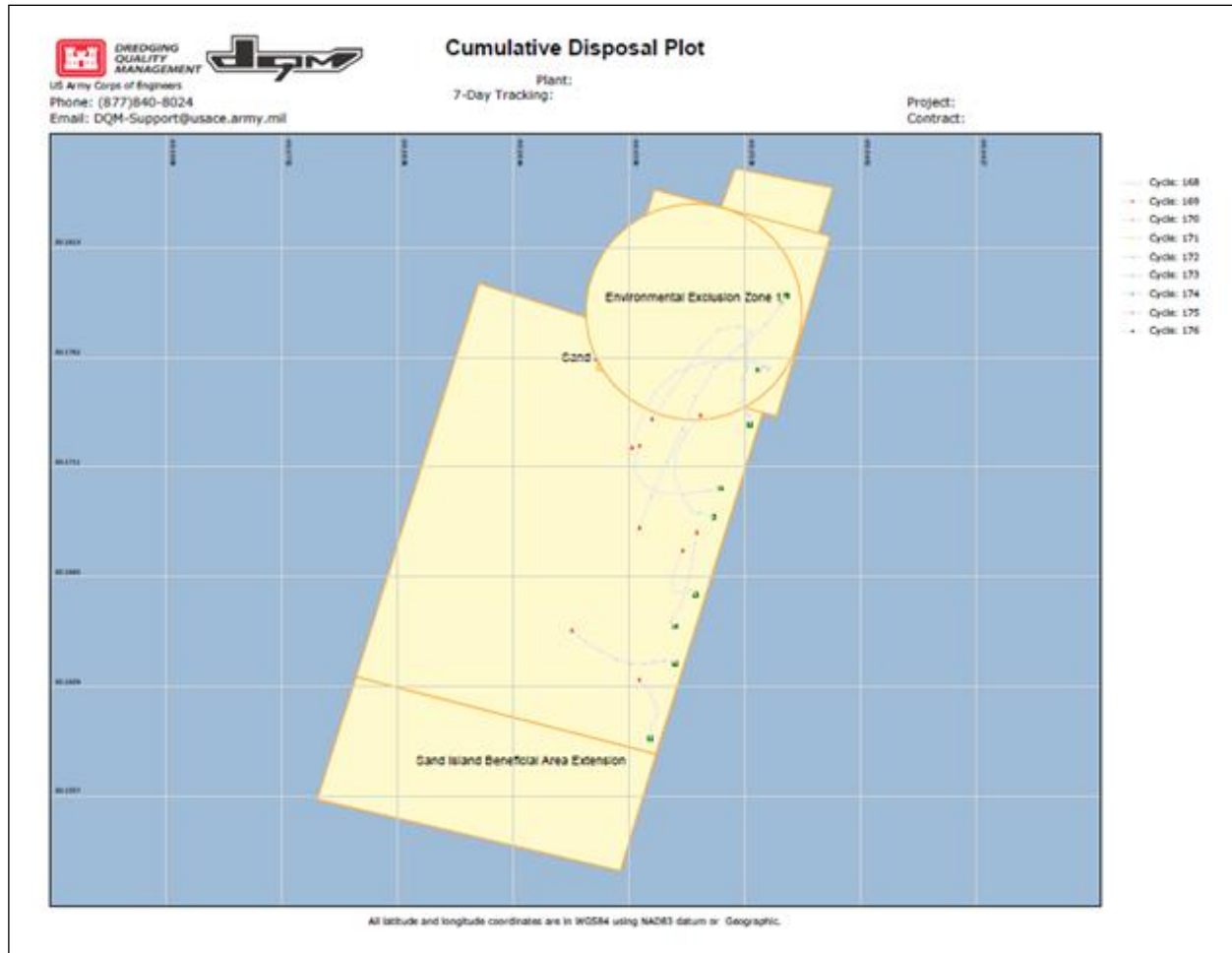

Figure 2-67. Screenshot of a DQM Cumulative Disposal Plot (2)

d. Additionally, DQM provides the site manager with a DQM EPA report (Figure 2-68), which was developed through a collaborative effort between DQM, EPA Region 4, CESAD districts. DQM and EPA Region 4 jointly developed a data format that standardizes the EPA dredging data reporting requirements for the CESAD districts. The DQM data is compiled into an Extensible Markup Language (XML) data format that is easily imported into the EPA Region 4 dredging monitoring system. The data set includes items such as vessel information, position and sensor data, and disposal information. This new format has greatly reduced the burden on the districts and contractors and has helped standardize a template that can be reused by other EPA regions.

**EPA Vessel Monitoring Data**

**Project Information**

**Contract:** SAC+WP12HN-  
**Placement Area:** Example Norfolk      **Site Type:** 102  
**\* Profile:** Monitoring  
**Coordinate Type:** LL  
**\*\* State Plane Datum:**

\* Optional field, data may not be required for project.  
\*\* State Plane Datum not required when Coordinate Type is LL

**Load Number: 62**

**Vessel Name:**      \* Type: Hopper \* Technique: Bottom Dump  
**\* Tow Vessel Name:**  
**\* Vessel Captain:**  
**Estimated Volume:** 1085  
**Material Description:** sand  
**Material Source:** North Turning Basin  
**Disposal Start Time:** 03/08/10 00:07:13  
**Disposal End Time:** 03/08/10 00:10:09  
**Disposal Start X:** -79.757454  
**Disposal Start Y:** 32.645969  
**Disposal End X:** -79.757896  
**Disposal End Y:** 32.64558  
**\* Observed Water Depth:**  
**\* Comments:**

**Position/Sensor Data**

Sample Date Time	Vessel X	Vessel Y	*Fore Draft	Aft Draft	*Avg Draft	*Vessel Speed	*Vessel Heading	*Vessel Course	*Hull Status
03/07/10 00:00:04	-79.754631	32.6549	23.55	25.28		5.4	191	181	Closed
03/07/10 00:00:15	-79.754684	32.654633	23.56	25.28		5.3	191	193	Closed
03/07/10 00:00:26	-79.754745	32.654366	23.53	25.32		5.3	192	190	Closed

QC Legend: OK, Error, Range Error, Suspect, QC

Figure 2-68. Screenshot of a DQM EPA Report

### 2.40.3.3 Automated Dredging and Disposal Alternative Modeling System (ADDAMS)

a. Planning, design, and management of dredging and dredged material placement projects often require complex or tedious calculations or involve complex decision-making criteria. In addition, the evaluations must often be done for several placement alternatives or placement sites. The Automated Dredging and Disposal Alternative Modeling System (ADDAMS) is set of continually evolving, state-of-the-art, PC-based tools that increase the accuracy, reliability, and cost-effectiveness of dredged material management activities in a timely manner. More specifically, ADDAMS provides the necessary tools to perform the engineering and planning evaluation for development of a long-term management strategy for dredged material placement and to evaluate the environmental acceptability of dredged material management alternatives. It was developed in response to requests by USACE field offices for tools to evaluate dredged



material management alternatives more quickly. More information about ADDAMS modules is presented in paragraph 2.34.2.3 and Appendix F, “Automated Dredging and Disposal Alternatives Modeling System (ADDAMS),” of this EM. Self-extracting executable models and documents can be downloaded from <http://el.erdc.usace.army.mil/products.cfm?Topic=model&Type=drmat>. ADDAMS includes the following applications for managing dredged material placement and evaluating environmental acceptability of dredged material placement alternatives:

- (1) CDF—Integrated Confined Disposal Facility design module (SETTLE and DYECON).
- (2) CDFATE—Computation of mixing zone size or dilution for continuous discharges.
- (3) D2M2—Optimization of long-term operation, expansion, and acquisition of multiple placement sites for multiple dredging reaches, including beneficial use.
- (4) DREDGE—Resuspension of sediments and contaminants by dredging.
- (5) DYECON—Determination of hydraulic retention time and efficiency of CDFs.
- (6) EFFLUENT—Combined effluent pathway evaluation module (EFQUAL and LAT-E).
- (7) EFQUAL—Analysis of modified elutriate test results for prediction of effluent water quality and dilution requirements for confined placement facilities.
- (8) HELPQ—Evaluation of runoff and leachate production and leachate quality.
- (9) LAT-E—Analysis of water column bioassay test to compute toxicity (LC50) of CDF effluents.
- (10) LAT-R—Analysis of water column bioassay test to compute toxicity (LC50) of CDF Runoff.
- (11) MDFATE—Fate of dredged material from multiple disposals in open water (currently being replaced by the MPFATE model; see the Dredging Tool Box).
- (12) PSDDF—Evaluation of consolidation, compression, and desiccation of dredged fill for determining long-term storage requirements.
- (13) PUP—Prediction of contaminant uptake by freshwater plants.
- (14) RECOVERY—Evaluation of contaminant release from bottom sediments and subaqueous caps (being replaced by the CAP model).
- (15) RUNOFF—Combined runoff pathway evaluation module (RUNQUAL and LAT-R).
- (16) RUNQUAL—Comparison of predicted runoff water quality with standards.

(17) SETTLE—Design of Confined Disposal Facilities (CDFs) for suspended solids retention and initial storage requirements.

(18) STFATE—Short-term fate of dredged material disposed in open water for predicting deposition and water quality effects (also available through the Dredging Tool Box).

b. Figure 2-69 shows the currently available ADDAMS applications categorized into dredged material management and environmental effects evaluation. The applications involving management of dredged material placement or evaluation of environmental acceptability of dredged material placement alternatives are described in detail in their respective placement application in Chapters 3 and 4 of this EM. The ADDAMS family of applications and supporting documentation is available at <http://el.erdc.usace.army.mil/products.cfm?Topic=model&Type=drmat>.

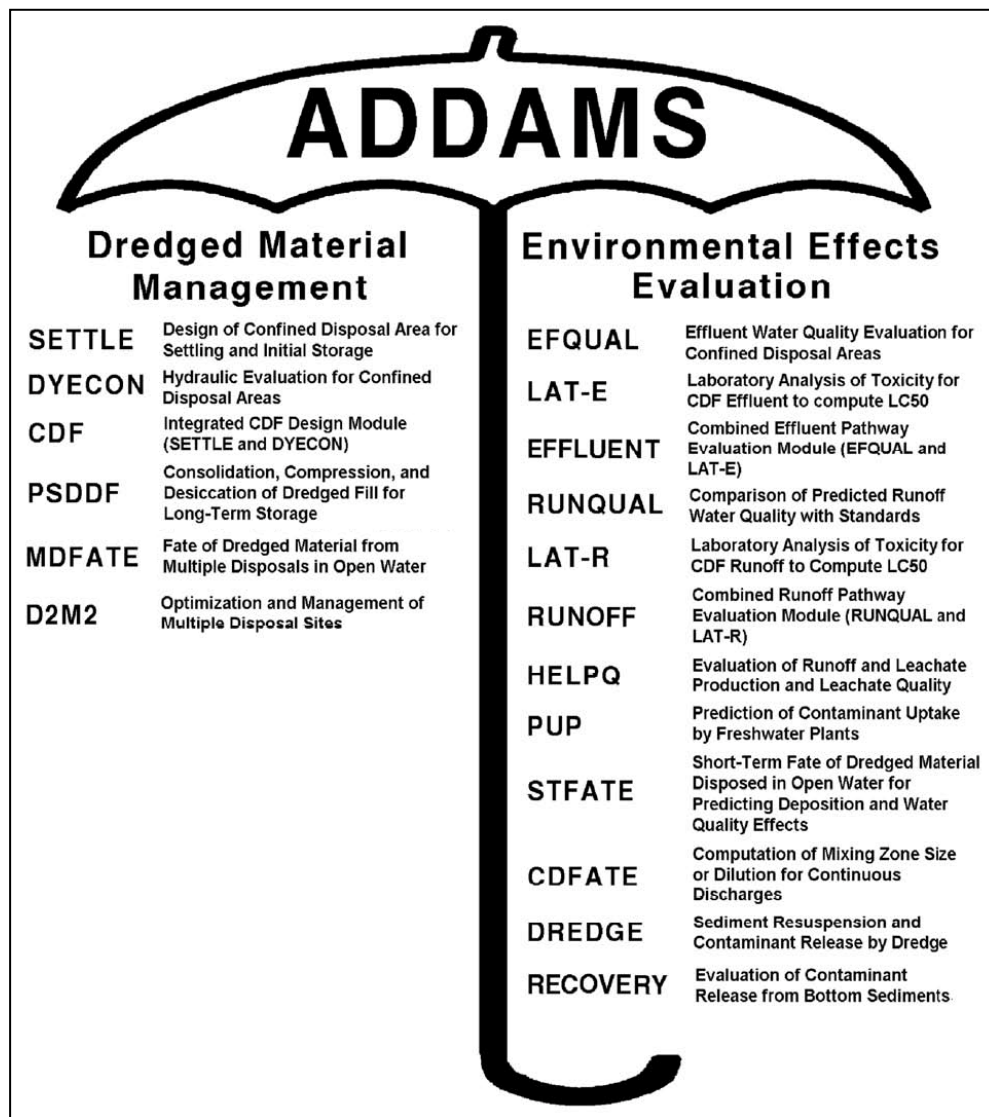

Figure 2-69. ADDAMS Applications Categorized into Dredged Material Management and Environmental Effects Evaluation

## CHAPTER 3

### Open-Water Placement

#### 3.1 Overview of Open-Water Placement.

3.1.1 Purpose. This chapter provides guidance for placing dredged material in open-water sites. It describes open-water placement environments, associated dredging and placement processes, and placement site management practices; discusses techniques to predict the short- and long-term movement of dredged material at the placement site for purposes of evaluating site capacity; provides guidance for required environmental evaluations of open-water discharge (including contaminant pathways), for evaluating and designing placement alternatives for uncontaminated and contaminated material in addition to descriptions of contaminant control measures for open-water placement; and presents operational procedures and equipment configurations to control dispersion at the site.

3.1.2 Description of open-water placement. Open-water placement is a major alternative for managing dredged material. Open-water sites are located in riverine, lacustrine, estuarine, and marine environments and are basically bottom-surface areas with overlying volumes of water, where specific dredged material placement activities are permitted. Dredged material is typically placed in open-water sites by hydraulic pipeline, hopper, and mechanical dredges. Uncontained open-water placement sites are either predominantly dispersive or nondispersive. At predominantly dispersive sites, material may be dispersed either during placement or eroded from the bottom over time, and it is transported away from the placement site by currents and/or wave action. At predominantly nondispersive sites, most of the material is intended to remain on the bottom following placement and may be placed to form mounds. Open-water sites used for dredged material placement are formally designated, selected, and managed to facilitate the necessary dredging and subsequent placement of dredged sediments.

3.1.3 Considerations for open-water placement. The basic design objectives of an open-water placement site are to provide storage capacity required to meet the dredging requirement and to provide this capacity while minimizing potential adverse impacts to the aquatic environment and human health. Selection of open-water placement as a management alternative should be based on environmental, technical, economic, and regulatory considerations.

3.1.3.1 Environmental. A wide range of placement site factors, including physical, biological, and chemical site characteristics as well as dredged sediment characteristics that may provide potential environmental impacts to the water column and bottom environment, must be considered when selecting open-water sites, equipment, and placement techniques for dredged material. The physical impact of the dredged sediment characteristics, together with dredging and placement operations at an open-water site, must also be considered.

3.1.3.2 Technical. Technical considerations for open-water placement include selection of appropriate equipment and placement techniques. This selection process must consider environmental and dredged material characteristics to minimize potential adverse impacts to the aquatic environment and human health.

3.1.3.3 Economic. Both environmental and technical factors must be considered to determine the most economically feasible method for placing dredged material in open water.

3.1.3.4 Regulatory. The acceptability of open-water placement from an environmental standpoint must be determined by appropriate ecological evaluations. The USACE has a major regulatory role for open-water placement under both Section 404 of the Clean Water Act (Public Law 92-500) and Section 103 of the Ocean Dumping Act (Public Law 92-532). The primary Federal environmental statute governing transportation of dredged material to the ocean for purpose of placement is the Marine Protection, Research, and Sanctuaries Act (MPRSA), also called the Ocean Dumping Act. The primary Federal environmental statute governing the discharge of dredged and/or fill material into waters of the United States (inland of the baseline to the territorial sea) is the Federal Water Pollution Control Act Amendments of 1972, also called the Clean Water Act (CWA). All proposed dredged material placement activities regulated by the MPRSA and CWA must also comply with the applicable requirements of the NEPA and its implementing regulations. In addition to the MPRSA, CWA, and NEPA, there are a number of other Federal laws, Executive Orders, and other legislative items that must be considered in the evaluation of dredging projects. For more detailed information, see paragraph 2.4.

3.1.4 Technical framework for open-water site evaluations. A Technical Framework for evaluation of dredged material placement alternatives, developed by the USACE and the USEPA (USEPA/USACE 2004), offers steps for detailed assessment of the open-water placement dredged material management alternative:

- a. Determine the placement site characteristics.
- b. Evaluate the direct physical impacts and site capacity.
- c. Evaluate the contaminant pathways of concern.
- d. Evaluate the water column and benthic control measures.

The flowchart in Figure 3-1 illustrates the major steps and components of open-water placement as an option. In this figure, “FLOWCHART 3-1” refers to the flowchart in Figure 2-57 of this EM. The paragraphs in this chapter generally address the steps provided in Figure 3-1. Additionally, open-water site management of placement operations and monitoring the site for changes are also important to consider for protection of the environment. These issues are discussed in the final paragraph of this chapter.

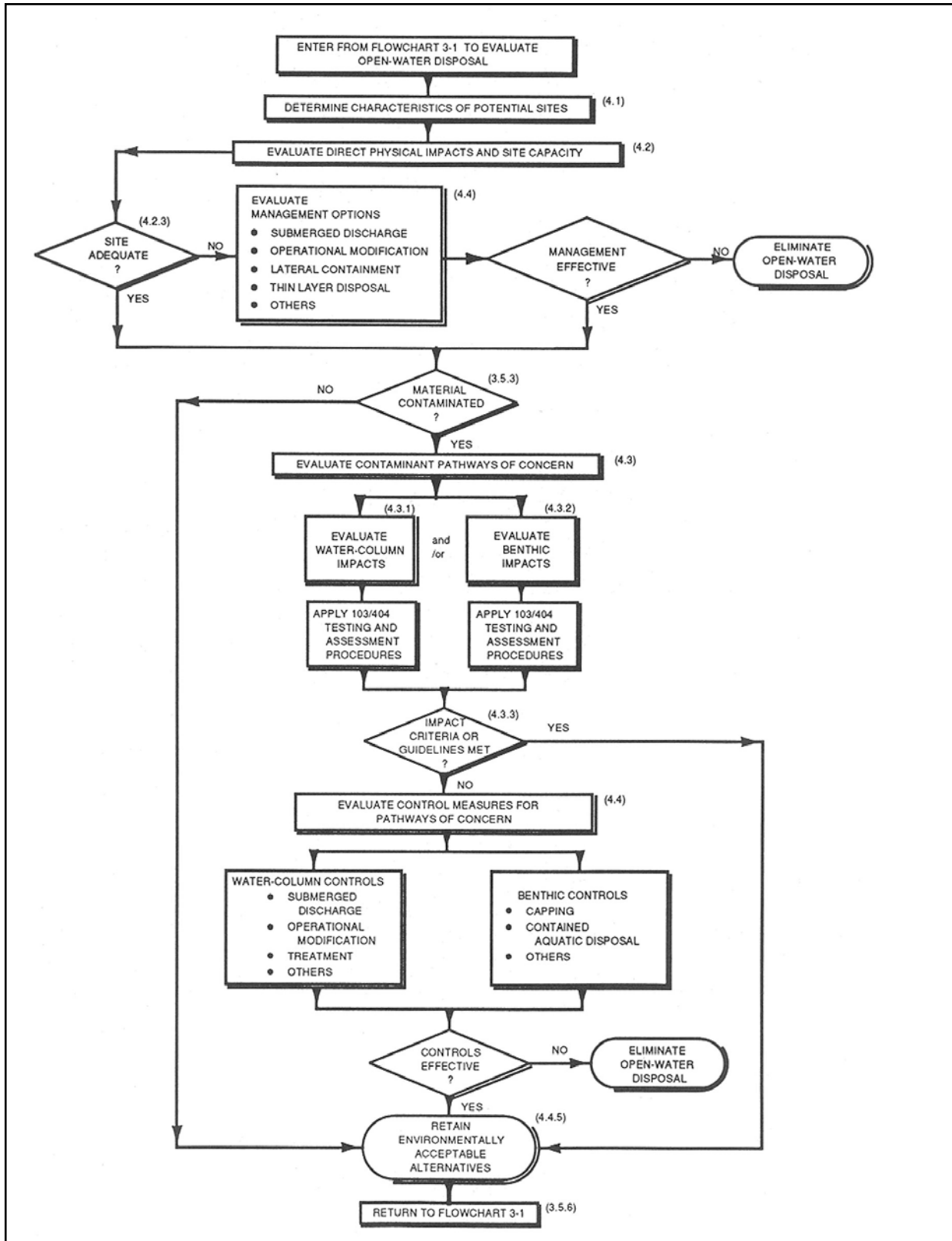

Figure 3-1. Major Steps and Components of Open-Water Placement (from USEPA/USACE 2004)

### 3.1.5 Technical guidance.

3.1.5.1 The design, operation, and management of open-water placement sites can become quite complex, depending on the operational constraints, site conditions, and characteristics of the dredged material. A wide range of guidance documents regarding open-water placement design, operation, and management have been generated under various USACE research programs at the Engineer Research and Development Center (ERDC) and through various site-specific studies by USACE Districts and Divisions. These efforts provide the foundation for the technical guidance on open-water sites found in this EM.

3.1.5.2 The Dredged Material Research Program (DMRP) was the first major USACE research effort addressing dredged material placement, and contained placement was addressed within several research areas of the program. DMRP research results provided the basis for initial USACE technical guidance on dredged material placement, including design, operation, management, and basic consideration of contaminant behavior.

3.1.5.3 Following the DMRP, research under the Field Verification Program (FVP), Long-Term Effects of Dredging Operations (LEDO) Program, Dredging Research Program (DRP), and Dredging Operations and Environmental Research (DOER) Program and technology transfer efforts under the Dredging Operations Technical Support (DOTS) program have led to the development of a variety of technical reports, technical notes, engineer manuals, and other guidance documents related to open-water placement. Information about these USACE research programs and publications can be found online at <http://el.erd.c.usace.army.mil/dots/>.

3.2 Open-Water Environments for Dredging and Placement. This paragraph describes the four major hydrodynamic environments associated with open-water placement in oceans, estuaries, rivers, and lakes along with considerations in the selection and use of various types of dredging equipment and techniques for each environment.

3.2.1 Ocean environment. Within the ocean environment, dredging activities are conducted primarily in three distinct zones: the continental shelf, the continental slope, and the inlet zone. The inlet zone differs in that it is generally the only open-ocean zone in which both dredging and placement occur.

3.2.1.1 Continental shelf. The continental shelf is the submerged margin of continents and, by extension, it is also considered to include the shallow margins of oceanic islands. United States laws define the continental shelf as the seaward extension of the coast to a depth of 183 m (600 ft). It gradually slopes seaward from shore with an average drop of about 4 m (12 ft) per mile. Its outer limit, the shelf break, is marked by an increase in gradient to about 80 m per nautical mile (NM). The shelf break generally occurs at a depth between 110 and 146 m (360 and 479 ft). The continental shelf varies considerably in width, ranging from a few miles off the west coast of the United States to as far as 250 km (135 NM) off parts of the Gulf coast, and it is a high-energy environment that is affected by wave, swell, and strong onshore, offshore, or longshore currents. The continental shelf is subdivided into the inner, middle, and outer zones on the basis of their hydrography and biology. The inner zone extends from shore out to a depth of about 20 m (65 ft), the middle shelf zone extends to depths of 70-80 m (230-262 ft), and the

outer shelf zone runs from the 80 m (262 ft) depth out to near the shelf break. About 70% of the ocean dredged material placement sites are located in the inner zone of the continental shelf. Other placement sites, such as those located offshore of Hawaii, Puerto Rico, Guam, and American Samoa, are located in the middle and outer zones of the shelf.

3.2.1.2 Continental slope. The continental slope may be thought of as a transition area between the shallow, highly productive waters of the shelf and the less productive waters of the deep oceans. The area of the slope is about twice that of the continental shelf, occupying 15.3% of the total area of the oceans, compared with 7.6% for the shelf. The slope has grades over 3° and sometimes as high as 25°. Most profiles across the continental slope show a steep, irregular upper slope and a smooth lower slope. Only a few of the ocean dredged material placement sites are situated on the continental slope.

3.2.1.3 Inlet zone. This complex zone is adjacent to the mouths of estuaries, rivers, inlets, and bays directly flowing into the ocean. Large volumes of sediment are constantly being reworked, and large volumes of material are dredged in the inlet zone because it experiences energy extremes similar to those of the continental shelf. However, it is also subjected to strong tidal currents, multidirectional wave effects, and the effects attributed to control structures such as jetties, and it is significantly impacted during storms and passages of major frontal systems. Areas outside of this zone, namely downdrift beaches, can accept large volumes of material from bypassing operations.

3.2.1.4 Environmental influence on dredge selection. The open ocean environment is subject to significant wave swell action. Dredges designed for inland channel operations (for example, cutterhead dredges) cannot operate in this environment. In order to dredge in an open-ocean environment (generally in or just outside the inlet zone), a dredge capable of withstanding the severe ocean wave climate must be used. Hopper dredges and a few hydraulic pipeline dredges are designed for placement in such conditions. Oceangoing tugs and certified barges are also available to transport material to ocean sites.

3.2.2 Estuarine environment. An estuary is broadly defined as a semienclosed coastal body of water that has a free connection with the open sea and within which sea water is measurably diluted with fresh water derived from land drainage. Estuarine systems can be divided into four distinct zones where placement sites may be located: the tidal mouth, central bay, tributary mouth, and upper bay.

3.2.2.1 Tidal mouth. This area is generally dominated by ebb- or flood-tidal-influenced sand shoals that may change with each tidal cycle, seasonally, or only during storms. Besides the strong tidal flows, heavy wave action is usually experienced on the seaward side of the entrance zone. Generally, this is a zone with much dredging but very little placement.

3.2.2.2 Central bay. Having a fine-grained bottom sediment, this estuarine zone is generally an area of potential sedimentation. Water depth and proximity to navigation channels dictate the fate of dredged material deposits. This zone is usually dominated by tidal currents with a net nontidal component. Wave action usually depends on wind direction and fetch length. Areas of

measured accumulation of fine sediment within this zone are potential nondispersive placement sites for dredged material if the water depth is sufficient.

3.2.2.3 The tributary entrance. This zone may represent an area of shoaling, highly cyclic currents, and possibly significant wave activity. Dredging and placement operations often occur within this zone, and the sediment may vary from fine clay to sand. Material disposed in this environment is subjected to periodic erosion from natural physical processes, fisheries activities, and shipping operations.

3.2.2.4 The upper bay. The upper reach of the system, this zone is characterized by a low-energy tidal zone. Fine silt and clay make up the predominant bottom sediment. This region usually supports a substantial fishery and, in most major estuarine systems, is highly populated and industrialized. Material from maintenance dredging in this zone is often placed in confined placement or ocean site areas to minimize impact on the fishery.

3.2.2.5 Estuarine current characteristics. In estuarine systems where the tidal prism (the volume of water entering from the sea during flood phase of the tide) is large in relation to the daily freshwater runoff, currents are oscillatory with pronounced ebb and flood phases. Examples include the Hudson River and the Chesapeake Bay. In a few estuaries, such as the Mississippi River, riverflow dominates tidal currents with the result that the flow is usually uniformly downstream, showing the tidal effect only in its speed and stage variation. Broad, shallow estuaries with small river inflow and small tides, such as Mobile Bay, are subject to dominant wind-induced unidirectional currents. Depending on the estuarine geometry, reversing tidal currents maybe strictly bidirectional, with a predominant ebb direction and flood direction and a slack period of near-zero current speed, or they may be rotary, swinging through a range of compass headings during the ebb and flood phases with or without a slack period. Density gradients caused by differences in dissolved solids content and water temperature impose both vertical and horizontal circulation patterns on the tidal currents. The pattern of stronger upstream currents near the bottom and stronger downstream currents near the surface can lead to net upstream flow in the lower layers of the water column. The pattern can be expressed as a flow predominance that indicates the percentage of flow in either direction at a given point in the water column. Between the downstream predominance of the river and the upstream predominance of the bottom currents in the lower estuary, null areas occur in which there is no net flow predominance in either direction. This, of course, has serious implications for transport of sediments through the estuary.

3.2.2.6 Environmental influence on dredge selection. All dredge types are commonly used in estuarine environments. The location of channels within the system often determines whether sediments are placed in open-water or confined placement sites by pipeline dredges or hauled out of the system to a nearby ocean placement site by hopper dredges or barges. Factors such as the wave climate and type of sediments to be dredged also dictate specific dredge types. Channels that pass through marshes can be difficult to dredge because dredged material cannot be readily placed in marshes without impairing wetland functions. Hence, effort is spent finding scarce upland sites, or additional costs are incurred transporting dredged material to other areas. To help alleviate this situation, several groups have proposed that thin-layer placement (hydraulically placing dredged material in single layers of 5-15 cm [2-6 in]) will reduce environmental impacts



sufficiently that placement in some marshes may become acceptable. If this is true, maintaining channels that pass through wetlands, especially those in remote areas, may be facilitated. Wilber (1993) and Ray (2008) present additional information on thin-layer placement history and project planning and monitoring.

3.2.3 Riverine environment. Like estuaries, rivers have quite variable physical flow characteristics and configurations. The characteristics of a river are determined by the geological system through which it flows and range from unidirectional freshwater tributaries to transitional estuarine systems. Unidirectional-flowing rivers have a relatively constant environment of deposition throughout their length while more complex river systems may have a full spectrum of depositional environments to consider.

3.2.3.1 Unidirectional. Rivers and those sections of rivers with this type of flow characteristic generally have sandy bottom sediments and are dredged primarily by hydraulic dredges with pipeline placement in areas adjacent to the channels or in upland placement areas. The fate of dredged material placed in areas adjacent to the channel is dependent on the current speeds and stage of the river.

3.2.3.2 Upper tidal. This zone experiences tidal fluctuations, but it is fresh water with seasonal low-flow periods when a salt wedge may develop. Material dredged from this zone and placed adjacent to the channel may be significantly affected by ship wakes and propeller wash.

3.2.3.3 Salt wedge zone. Where river water mixes with ocean water, there is a complex zone that is generally described as a salt wedge. At this section of a river (or estuary), a mixing process causes enhanced deposition and a turbidity maximum in the water column. This zone usually represents an area of constant shoaling and thus constantly requires dredging and placement. If material is placed in this part of the river, it will also experience tidal currents that may be sufficient to erode and rework the sediment.

3.2.3.4 River mouth. The mouth of a river can be a complex deltaic system, such as the mouth of the Mississippi River, or a relatively simple tidal opening into an estuary or ocean. The variability is as great as the number of rivers. This depositional environment is site-specific and depends on the energy regime and tidal range of each river. Many characteristics for this zone of a river are the same as previously described for estuary mouths and tributary entrances.

3.2.3.5 Environmental influence on dredge selection. In comparison with ocean, estuarine, and lake environments, rivers are subject to less significant wind-wave swell. Short distances between dredging and placement sites are also more common to riverine environments. Therefore, the USACE was able to develop more specialized equipment and procedures specifically for dredging river channels. Cutterhead and dustpan dredges are commonly used in riverine environments. A major factor in river dredge selection is the type of suction head, which in turn is based on the type of sediment to be dredged. Some rivers are dredged by mechanical dredges where transportation distances exceed pumping capabilities of pipeline dredges. Hopper dredges are commonly used at river mouths for transporting dredged material offshore and because of their mobility.

### 3.2.3.6 Riverine placement methods.

a. Open-water placement techniques for riverine sediments are similar from one type of hydraulic dredge to another. Continuous pipeline placement with some type of baffle plate to diffuse discharge is standard practice. Dredged material may be disposed within the banks of the river, with the intent of providing guidance to the channel flow or erosion protection, or simply placed where it is hoped to have no unfavorable influence upon the stability of the dredged channel. In smaller rivers where the channel width is essentially the same as the river width, dredged material is commonly disposed at diked upland placement sites.

b. Open-water placement with the intent of providing guidance to channel flow is the most ideal method, but it is also the most difficult approach. The danger exists that when placement of material is not exact, a large part will return into the newly made channel. However, using river mechanics, flow patterns, and changes with time, this method can provide a stable channel that may be partially maintained by the more concentrated flow. Dredged sediment grain size also influences the effectiveness of this approach. Coarse particles settle rapidly to the river bottom; fine particles may take a long time to reach the bottom, and their area of deposition is more difficult to predict.

c. Placement of material within the river where it is hoped to have no adverse effects on navigation is the simplest of riverine placement methods. This technique differs from the previous method in that it does not have the benefit of increased velocity within the channel to reduce material deposition. A variation of this method is agitation dredging. As with estuaries, thin-layer placement, as described above, may have application in channels through marshes.

### 3.2.3.7 Thalweg placement of dredged riverine sediments.

a. The thalweg can be described as the deepest flow channel within the banks of a river. Cross sections in bends are triangular in shape with the deepest points located near the concave bank and shallow point bars located on the convex bend. In the transition zone between bends, flow lines straighten, and the cross section takes the form of a wide, shallow trough forming a saddle or bar. A sequence of mounds and scours is common to both meandering reaches and straight reaches with a thalweg that meanders through alternate bars. Consequently, the thalweg profile exhibits a series of pools separated by shoals, or crossings, which tend to aggrade during high-discharge periods, and pools are scoured. At low discharges the cross-sectional areas of the crossings and pools change: the crossings scour, and the pools become depositional areas for the scoured material. Thalweg placement involves removing material from these shoals and depositing it in the nearest pool, resulting in a channel bottom with a more uniform depth.

b. Early dredging efforts used thalweg placement. The first devices employed for dredging on the Mississippi River used a stirring or scraping technique. In operation, a dredge equipped with a scraper frame on the bow moved to the upstream end of shoals, lowered the scraper frame, and then backed slowly downstream, scraping sediment with it into pools below these shoals.

c. The U.S. Army Portland Engineer District tested the thalweg placement technique in 1971 with favorable results. The potential environmental benefits are numerous, particularly in regard

to avoiding shallow water or wetland placement with the consequent impacts on chute channels, sloughs, and backwater areas. Other experiments by the U.S. Army Rock Island Engineer District revealed that dredged sand disposed in the thalweg remained there and was not widely dispersed into potentially sensitive aquatic habitats. For environmental effects evaluation and implementation approach on thalweg placement of dredged material, refer to Olin, Miller, and Palermo (1993a and 1993b), respectively.

3.2.4 Lake environment. This environment involves primarily the Great Lakes region. The physical processes are very similar to those of an estuary or the open ocean, but the source of energy is not the same. Generally, lake bottom currents are affected by the wind direction, the thermal stratification of the water column, and the proximity to rivers (Hough 1958). Water elevation can also be affected by wind velocity. Dredged material within the Great Lakes is placed in open lake depths ranging from 2 to 30 m (6 to 100 ft). Studies near Ashtabula, OH (Danek et al. 1977) have shown that dredged material deposits in 15 m (50 ft) or less of water are susceptible to removal by winter storms. The dredging practice and lake placement operations are similar to those described previously for the ocean and estuarine environments.

### 3.3 Physical Fate of Dredged Material Placed in Open Water.

#### 3.3.1 Introduction.

3.3.1.1 Efficient management of open-water placement sites requires the ability to predict and track the movement, or fate, of dredged material upon release. This ability is essential to meet the environmental requirements for site selection and use (that is, water quality standards and site size and capacity) and determination of operational constraints related to placement methods. The short-term fate of dredged material includes its effects as it descends through the water column and settles on the bottom in the near field (the vicinity of the placement area) within the minutes and hours following its release. Its long-term fate involves dredged material mound erosion and resuspension over longer time frames, such as years, and the redeposition of this material. Long-term management of aquatic disposal sites also requires an understanding of how much area the dredged material mound encompasses, when the mound encroaches on the site boundaries, how much material leaves the site, and where the material ultimately goes.

3.3.1.2 Factors influencing dredged material behavior at open-water placement sites include the following:

- a. The physical characteristics of the dredged material, such as its particle size distribution and mineralogical composition.
- b. The nature of the placement operation, such as the type of discharge vessel, discharge rate, and solids concentration of the slurry.
- c. The physical environment in the vicinity of the placement site, including currents, waves, tide, and storms.

d. Bottom sediment characteristics and topography (Johanson, Bowen, and Henry 1976; Barnard 1978).

e. Water depth.

The great variability of these factors from site to site, as well as potential seasonal fluctuations, increases the difficulty of predicting open-water dredged material behavior.

3.3.1.3 Hopper dredge or barge and pipeline are the typical placement methods of dredged material in open water. Release to the receiving water is the only aspect of dredged material placement over which direct control can be exercised by conventional dredge operations. Once the material is released from the dredge, the mechanics of the transport phases is beyond manipulation by operators.

3.3.1.4 Hopper dredging results in a dredged material mixture of water and solids stored in the hopper or bin for transport to the placement site. At the placement site, hopper doors in the bottom of the hull of the ship are opened, the entire hopper contents are emptied in the open water in a matter of minutes, and then the dredge returns to the dredging site to reload. This procedure produces a series of discrete discharges at intervals of perhaps one to several hours.

3.3.1.5 Bucket or clamshell dredges remove the sediment being dredged at nearly its in situ density and place it on a barge or scow for transportation to the placement area. Although several barges may be used so that the dredging is essentially continuous, placement occurs as a series of discrete discharges. The mechanically dredged material may be a slurry similar to that in a hopper dredge, but often sediments dredged by clamshell remain in fairly large consolidated clumps and reach the bottom in this form. Similar to hopper dredge placement operations, barges are designed with bottom doors or with a split hull, and the contents may be emptied within seconds, essentially as an instantaneous discharge.

3.3.1.6 Pipeline dredges produce a slurry mixture of water and solids (sediments), with solids concentration ranging from a few grams to several hundred grams per liter. This slurry is transported by pipeline and discharged at the placement site in a relatively continuous stream. Placement from a cutterhead or other hydraulic pipeline dredge is continuous in that the placement site receives a constant flow of material until the pipeline discharge port is repositioned to another site, operations are interrupted (for example, the swing anchors are repositioned or there is passing traffic), or dredging ceases. Surface and near-surface turbidity around the area of pipeline discharge, in addition to water column effects and the spread of material along the bottom, are the main management considerations for open-water pipeline placement projects. The behavior of pipeline-discharged material can vary because of its initial trajectory (horizontal versus vertical) or whether it exits in the air or water. In addition, pipeline discharge ports may include a variety of baffle or deflector plates and cylindrical or conical diffusers, which can also affect the plume behavior (Teeter 2000).

3.3.1.7 The physical forces affecting both the short- and long-term fate of dredged material placed in open water include gravity and forcing due to waves and currents. Water column currents are the dominating environmental force acting on dredged material placed in open water.

Currents generally result from the combined actions of several components: large-scale ocean/coastal current regimes due to tidal circulation and/or storm-surge propagation, locally generated wind-stress-generated currents, inertial currents, and estuarine/riverine plume effects.

3.3.1.8 Mathematical models have been developed for predicting the short- and long-term fate of dredged material placed in open water for both bottom-release and pipeline placement. The short- and long-term fate of dredged material placed in open water for both conventional bottom-release placement (from a hopper dredge or barge) and pipeline discharge are described in 3.3.2 and 3.3.3, respectively. Numerical models used to predict the short- and long-term fates of dredged material placed in open water are also presented.

### 3.3.2 Short-term fate.

3.3.2.1 The short-term behavior of dredged material, once it has been released into open water from a hopper dredge and barge and from pipeline discharges, has been studied. The following section focuses on dredged material behavior during discrete placement events, such as placement from a hopper dredge.

3.3.2.2 Field evaluations from data obtained at five sites by Bokuniewicz et al. (1978) and physical model tests by Johnson and Schroeder (1993) have shown that open-water placement of dredged material from a hopper dredge or barge generally follows a three-step process:

- a. Convective descent, during which the material falls under the influence of gravity.
- b. Dynamic collapse, occurring when the descending cloud or jet either impacts the bottom or arrives at a level of neutral buoyancy, in which case the descent is retarded and horizontal spreading dominates (this spreading material is also referred to as an underflow).
- c. Passive transport-dispersion, commencing when the material transport and spreading are determined more by ambient currents and turbulence than by the dynamics of the placement operation (Moritz, Johnson, and Scheffner 2000).

Teeter (1992) analyzed the dispersion processes of dredged material discharged from a pipeline and described a three-step dispersion process for pipeline-placed material that is similar to that of hopper-placed material. In addition, fine sediments may be stripped from the descending jet. Figure 3-2 illustrates the three phases of dredged material released in open water from a hopper bin, and Figure 3-3 illustrates a similar sediment plume behavior from a pipeline discharge.

### 3.3.2.3 Convective descent.

a. During the convective descent phase, in almost every case for both bottom release and pipeline placement, the bulk of the dredged materials falls in a dense jet directly to the bottom with minor losses to the water column. Released dredged material possesses an initial downward momentum and a density greater than that of the surrounding water. These conditions result in forces that cause the material to settle in the form of a cloud, or density current, rather than as individual particles. As the cloud settles, shear stresses develop at the interface between the moving cloud and the ambient water, resulting in dissipation of the initial momentum and the

31 Jul 2015

creation of turbulent eddies that entrain ambient fluid. In the case of clouds possessing an initial momentum, vortex rings form at the time of release and tend to cause deeper penetration of the ambient water. The material that falls as clods acquires terminal speed after falling through a small fraction of the water depth and then descends to the bottom at a nearly constant speed. Any distribution of material between jet and clod descent is possible; the proportion of material in the two forms has a major effect on the structure of the resultant deposit at the placement site.

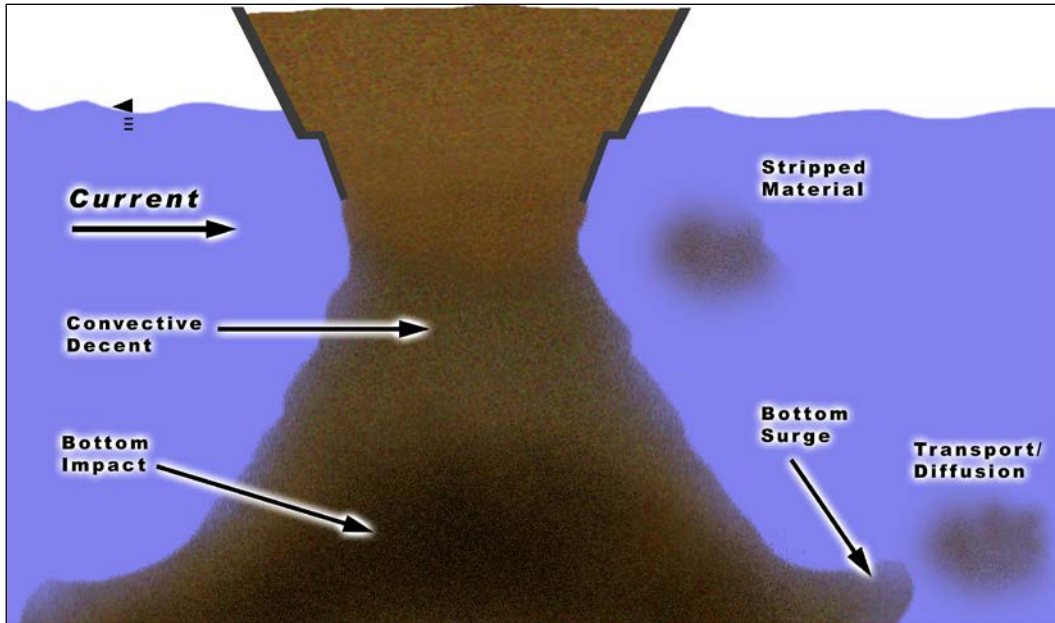

Figure 3-2. Schematic of the Behavior of Dredged Material Released in Open Water

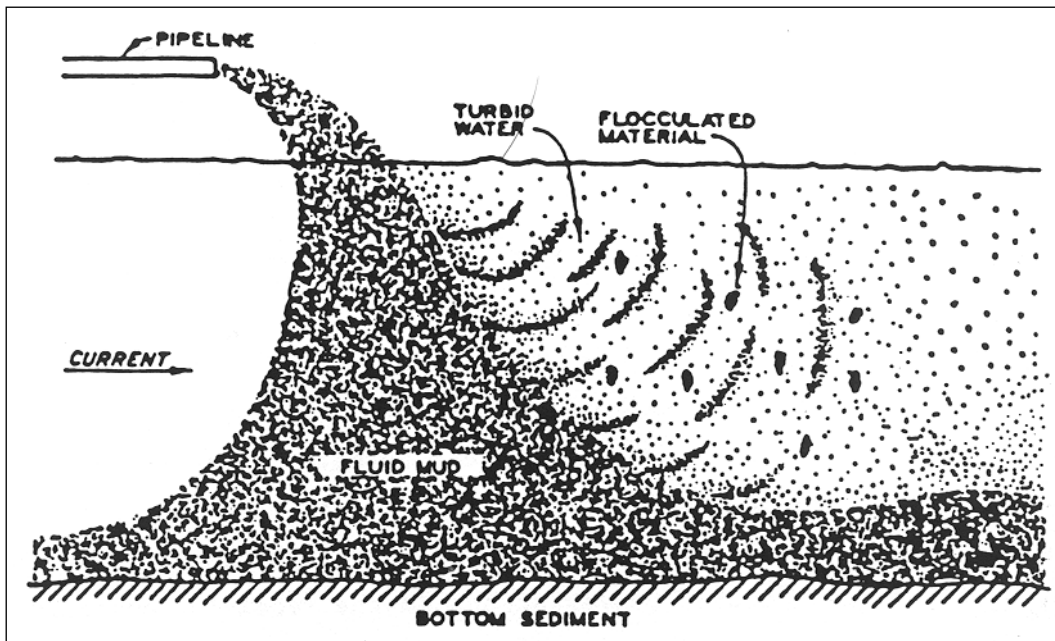

Figure 3-3. Schematic of the Sediment Plume from a Pipeline Discharge in Open Water

b. Bokuniewicz et al. (1978) observed that the jet falls at an early constant speed and to entrain a large volume of ambient water during transit from the surface to the bottom. For example, the volume of fluid reaching the bottom in the jet may be 70 times the volume released at the surface. Because of the large entrainment and the corresponding reduction in jet density, the jet quickly attains the lateral speed of any current flowing in the receiving water. Its impact point can be predicted with good accuracy if the current is known. The descent of the jet sets up circulation patterns in the ambient water inward toward the discharge point on the surface and outward on the bottom. The resultant inflow around the hull of the dredge or scow helps contain the dredged material in a narrowly defined zone of descent. The speed of this convective descent was measured by Bokuniewicz et al. (1978) and was consistently found to be about 1 m/sec (3.3 ft/sec).

c. Instantaneous placement of dredged material in relatively shallow water produces a rapid convective descent of the material with a vertical velocity on the order of 1 m/sec (3.3 ft/sec). Settling velocities calculated for individual particles do not apply during this form of transport. Since the time during which the cloud is in contact with the upper portions of the water column is a minute or less, ambient water currents (except near the bottom) are of little consequence except as they affect the transport of any turbidity cloud that may be generated during the descent. If near-bottom currents are low, precision placement may proceed under almost any current condition occurring in the upper portions of the water column, except for turbidity cloud considerations (Johanson, Bowen, and Henry 1976).

#### 3.3.2.4 Dynamic collapse.

a. Dynamic collapse occurs when the cloud encounters a boundary, either a density layer (pycnocline) or the bottom, and is characterized by horizontal spreading. Collapse is driven primarily by a pressure force and is resisted by inertial and frictional forces. In the case of precision placement of dredged material into a specific site, it is important that the cloud penetrate through any density layer and reach the bottom. In general, sudden releases of fairly large quantities of dredged material in shallow water penetrate a density layer and impact on the bottom. The cloud flattens out and appears somewhat like a disk as it assumes a horizontal circular shape (assuming a flat bottom and no obstructions) with a small vertical dimension. Under these conditions, flow continues in the form of a density or turbidity current.

b. If a clod of dredged material impacts the bottom at high speed, it disintegrates, and the contained material is dispersed. If the impact speed is low, the clod remains intact upon deposition. Clod disintegration can be avoided if the kinetic energy of the clod is dissipated by plastic deformation before material failure occurs or the clod arrives at the bottom. Since the kinetic energy per unit mass of a falling clod increases as the clod size increases, it is expected that there is an upper bound to the size of clods that can be deposited on the bottom intact.

c. At Ashtabula and Rochester, NY (Bokuniewicz et al. 1978), the base surge spread radially outward in the shape of a thin expanding toroid of turbid water. Both its thickness and speed decreased as its radius increased. As the surge proceeded outward, it shed behind a thin, slowly moving cloud of suspended dredged material that settled to the lake floor. The entrainment of ambient water and friction eventually caused the velocity of the surge to decrease to the point

where all its contained sediment was deposited. The initial energy of the surge and the rate of energy dissipation determine the range of the base surge, the area of the bottom that is covered by dredged material, and the form and thickness of this deposit. Ideally, the deposition of dredged material is expected to occur in a ring around the impact point.

d. To describe a bottom surge adequately, it is necessary to know its velocity as a function of distance from the impact point, its thickness, and the concentration of solids contained therein. If sufficient data are available, it is possible to determine whether erosion or deposition occurs at a given radial distance, whether additional ambient water is entrained, and how rapidly kinetic energy is lost. These data may then be used to estimate the size of the deposit that will be formed on any given aquatic disposal site.

e. The thickness of the base surge was found to depend on water depth: the greater the depth, the thicker the surge. Bokuniewicz et al. (1978) obtained base surge data at sites in the Great Lakes. As the water depth at the placement site increased from 20 to 50 m (65 to 164 ft), the greatest thickness of the surge increased from 4 to 7 m (13 to 23 ft). This result was expected since, at the greater depth, the volume of water entrained during descent was greater, but the speed of the surge over the bottom was not changed appreciably. The surge thickness was also observed to be relatively large at the New York Bight site (Bokuniewicz et al. 1978). While the water depth was greater there, the quantity of dredged material released was also much greater, and the surge spreading speed was higher. Data were insufficient to separate the effects of all of these variables in determining surge thickness. Figure 3-4 is a contour diagram defining the thickness of the base surge for the Ashtabula, Rochester, and New York Bight data after adjusting to the Ashtabula travel-time curve. The concentration of solids suspended in the base surge was determined from pumped water samples and from transmissometers. At the Great Lakes sites, concentrations were as high as 11 g/L within about 50 m (164 ft) of the impact point. Three minutes after the head of the surge had passed, the concentrations were down to about 1 g/L, and returned to background values in less than 15 minutes. These data are displayed in Figure 3-5.

f. May (1973) reported turbidity or density flows of sediments released from pipeline dredging and aquatic disposal operations. According to May, almost all the sediment settled very rapidly and flowed along the bottom as a separate, flocculated density layer or underflow. The sediment that was not deposited immediately under the dredge was transported in the density flow or base surge. Concentrations of 10,000 mg/L were found within 122 m (400 ft) of the discharge point, and concentrations over 1,000 mg/L extended out at least 550 m (1,800 ft).

3.3.2.5 Transport-diffusion. At most placement sites, the convective descent and dynamic collapse phases last on the order of only a few minutes. When the rate of spreading of the collapsing cloud becomes less than an estimated rate of spreading due to turbulent diffusion, the collapse phase is terminated and the "longer" term transport-diffusion phase is initiated. In this phase, material in suspension is transported and diffused by the ambient current while undergoing settling. Any non-sediment constituents are also transported and diffused. During the passive transport-diffusion phase, material transport and spreading are determined by ambient currents and turbulence rather than by the dynamics of placement operation. The clouds are transported by the velocity at the centroid of the cloud while experiencing both vertical and horizontal



turbulent diffusion. Suspended sediment concentrations in the clouds are assumed to have a Gaussian distribution. Solids settle by discrete settling or flocculant settling.

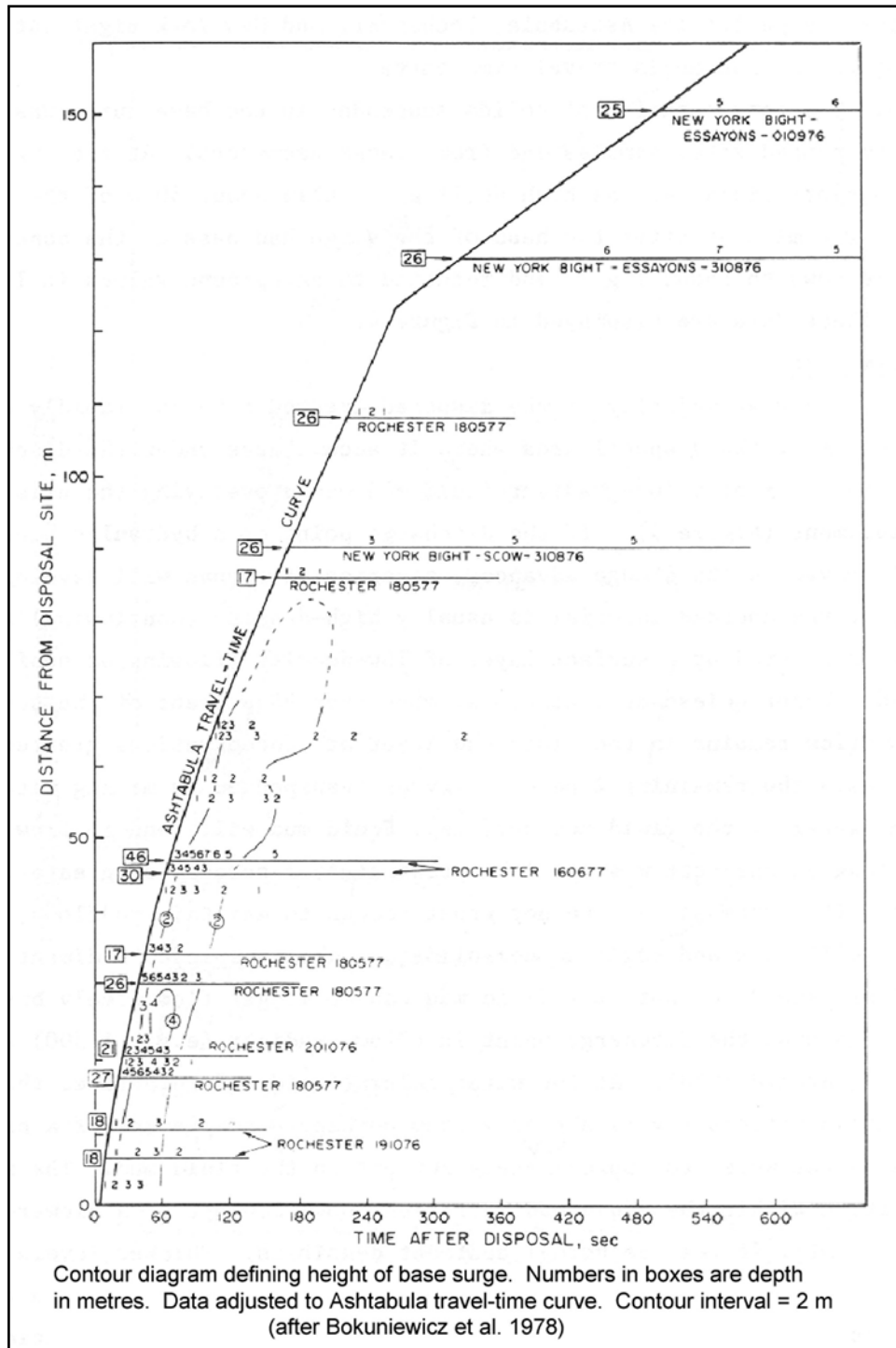

Figure 3-4. Adjusted Thickness (Height) of the Ashtabula, Rochester, and New York Bight Base Surge Data (Bokuniewicz et al. 1978)

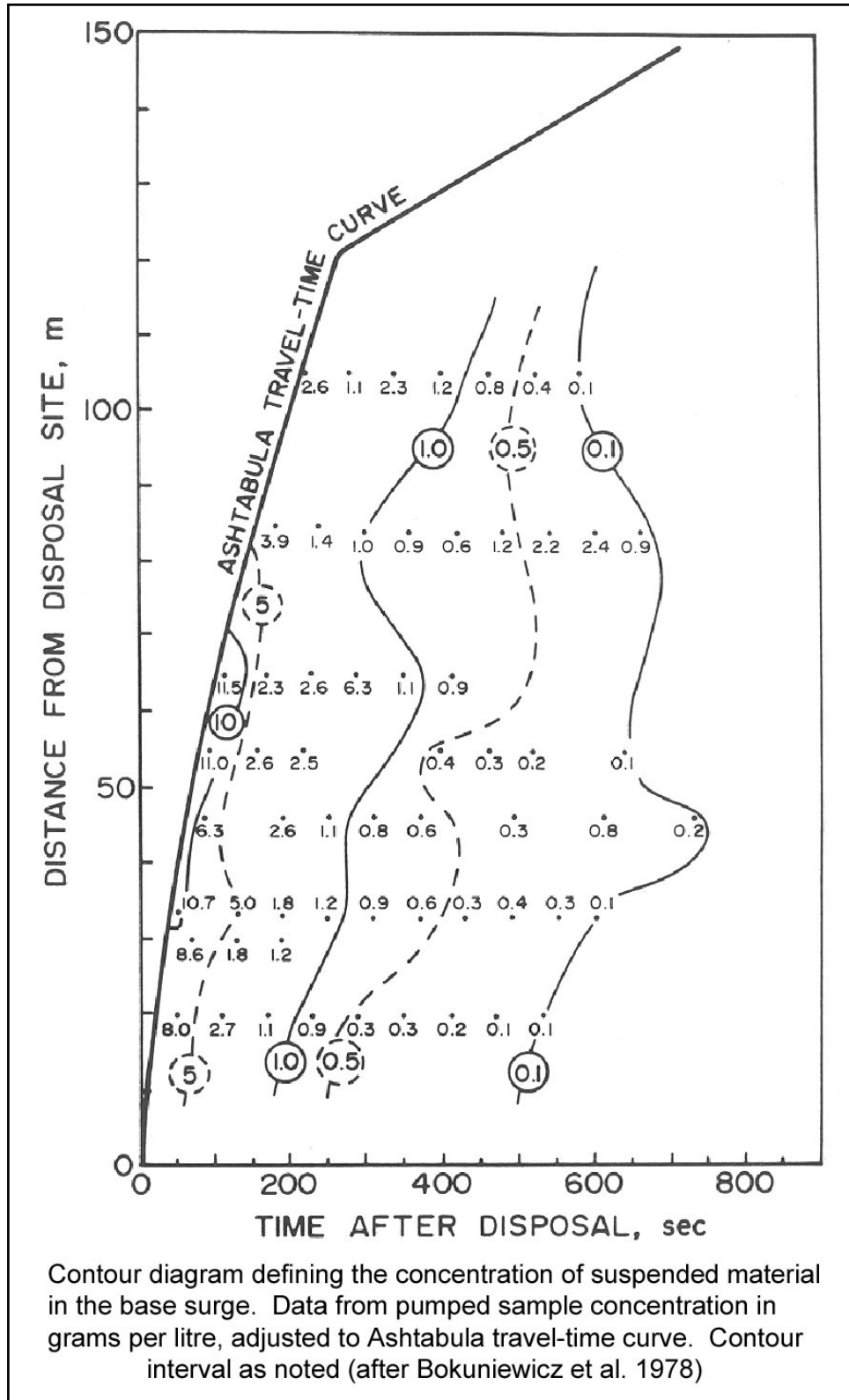

Figure 3-5. Concentrations of Suspended Material after the Base Surge in the Great Lakes (after Bokuniewicz et al. 1978)

### 3.3.2.6 Stripping of fine sediments.

a. The fate of fine-grained dredged sediments stripped from the descending jet during open-water placement can be an issue in some situations, such as concern over the impact of the water column plume and, especially, during the placement of contaminated sediments.

b. As noted earlier, during open-water placement of dredged sediments from a barge or hopper dredge, the vast majority of released dredged sediments descend rapidly to the bottom as a coherent, well-defined jet of material. However, some small fraction of fine-grained material can remain in upper and middle levels of the water column and, depending on ambient currents, may be transported from the site. This fine-grained material may be released to the water column in different ways. As the descending cloud or jet moves downward, a circulation is set up such that ambient fluid is entrained into the backside of the cloud or jet. This entrained fluid decreases the overall density of the cloud and the turbulent mixing created in the cloud or jet separates some of the fine-grained material from the denser core of sediments. These fine-grained particles are then left behind at different levels in the water column as the cloud or jet continues its descent to the bottom. They then settle at their particle-settling rate, but they can become trapped in the water column if stratification exists (typically seen only in deep water). This is one form of what is commonly called stripping.

c. Truitt (1986) provides a good summary of approximately nine major field studies where measurements were made to estimate the volume of sediments that are stripped from the main jet and remain suspended in the water column a considerable length of time. For the five studies that dealt with mechanically dredged sediment placed in barges, three studies had suspended sediment masses of 1%, and two studies had suspended sediment masses of 2%-4%. A study of dredged material placement in Hong Kong showed that loss of sediments due to stripping during barge placement of fine sediments into pits ranged from 1% to 3% (Land and Bray 1998).

d. Some portion of this 1%-4% mass of suspended sediments stripped from the main jet of material likely deposits in the immediate vicinity of the placement and thus remains inside most placement sites although the size of this portion will vary considerably with site and sediment characteristics. In cases where the remaining portion of the stripped material is an issue of concern, either it can be tracked as it moves in the water column or the area of concern adjacent to the placement area can be monitored to determine if measurable amounts deposit there. Tracking fine material in the water column is a very expensive undertaking with considerable uncertainty involved in measuring small amounts of suspended sediment over a wide area. Similarly, monitoring an adjacent sensitive resource for minute amounts of fines and/or their associated contaminants is also very expensive, time-consuming, and subject to some uncertainty. Therefore, such monitoring requirements are usually imposed in extraordinary situations, and only then to confirm numerical movement predictions through a limited number of monitoring events. To date, there has been no evidence that the amounts of "untracked" sediments stripped during the placement of contaminated have caused unacceptable environmental impacts. Thus, for the vast majority of dredging projects, no attempt is made to collect quantitative data on the fate of the stripped fraction because it is not considered to be cost-effective.

### 3.3.2.7 Mound formation.

a. For both bottom-release and pipeline-placed material, the bulk of the released dredged material rapidly descends to the bottom of the placement area where it accumulates under the discharge point in the form of a low-gradient (for example, 1:500), circular or elliptical fluid mud mound overlying the existing bottom sediment. If bottom slopes are not steep enough to maintain the low-density fluid mud flows, then the sediment suspended in the fluid mud layer tends to settle, and flow velocity decreases. The shape of the mound is affected by several factors: dredged sediment properties, placement method, and site characteristics, such as currents and bottom topography.

b. Muddy sediment dredged by a clamshell remains in large clumps and descends to the bottom in this form. The clumps may break apart somewhat on impact, but such material tends to accumulate in irregular mounds under the placement vessel rather than move outward from the release point. Whatever the dredging method, sandy sediment tends to mound directly beneath the pipeline port or release vessel.

c. Barnard (1978) studied the dispersal characteristics of pipeline-discharged material and discussed the characteristics of the fluid mud mound. If the discharge point of a hydraulic pipeline dredge is moved as the dredge advances, a series of mounds develops. The majority of the mounded material is usually high-density (nonflowing) fluid mud that is covered by a surface layer of low-density (flowing or nonflowing) fluid mud. Close to the discharge point, the mound may be pocked with conical hills and scour pits, formed from the continuous placement of material. Fluid mud tends to flow downhill as long as the bottom slope is approximately 1% or greater. Figure 3-6 shows the effect of discharge angle and predominant current angle from a pipeline dredge discharge on the shape of a fluid mud mound and is an example of the effect of varied placement configurations and site conditions on the overall shape of the mound, height, and slopes. However, for pipeline placement, the amount of slurry dispersion can be controlled by using various pipelines configurations at the discharge port (Barnard 1978).

### 3.3.3 Long-term fate.

#### 3.3.3.1 Background.

a. After dredged material has come to rest on the seabed, it can be eroded and transported by waves and/or currents. Furthermore, if the dredged material is cohesive, it can experience self-consolidation due to gravity. In addition, if many loads of dredged material are placed one on top of another such that a steep aggregate mound develops on the ambient bathymetry, the mound will avalanche and material will be transported downslope as a function of gravity and material characteristics. These combined processes define the long-term fate of dredged material placed in open water. Water depth, wave activity, and current regime are the primary factors that contribute to the long-term fate of dredged material placed at a given ocean dredged material disposal site (ODMDS).

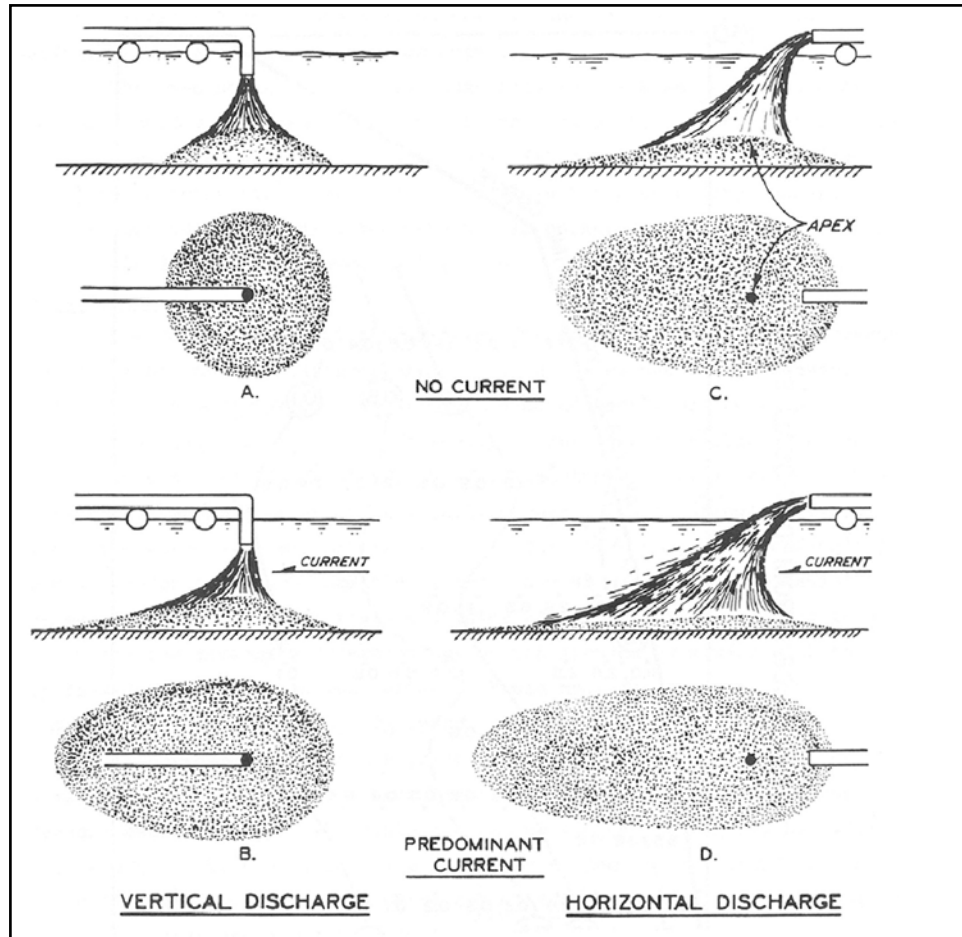

Figure 3-6. Effect of Pipeline Dredge Discharge Angle and Predominant Current Direction on the Shape of a Fluid Mud Mound

b. Depending upon the type of dredged material to be placed at an ODMDS and surrounding resources, long-term dispersiveness may or may not be a desirable aspect. If the placed dredged material is expected to remain within an ODMDS (due to incompatibility issues with ambient or adjacent resources), a site should be selected that minimizes long-term dispersiveness. If the goal of the ODMDS is to facilitate reintroduction of dredged material into the littoral system, then an ODMDS should be selected that maximizes long-term dispersiveness. The degree of long-term stability for dredged material placed at an ODMDS is an important factor that dictates the amount of dynamic site capacity for a given location.

c. An ODMDS can exhibit little dispersiveness during dredged material placement while having a high degree of long-term dispersion during moderate to severe wave or current activity. To predict the fate of dredged material placed in open water, the dispersiveness of an existing or new candidate ODMDS must be fully considered for both short-term and long-term aspects. Numerical models are required for these predictions. The following information was excerpted from Moritz, Johnson, and Scheffner (2000).

3.3.3.2 Resuspension of mound material. When water begins to flow over a bed of loose particles, hydrodynamic forces are exerted upon the particles; as the flow intensity increases, the magnitude of the hydrodynamic forces on the particles increases. A condition is eventually reached where the particles are unable to resist the forces and movement is initiated. Disposal mound dynamics depend on various forces, mound characteristics, armoring, and other processes, such as biological activity.

a. Forces causing resuspension. Dominant forces contributing to erosion and transport are stresses by currents caused by tides, density gradients, waves, winds, and episodic events such as storms. Sediment erosion and transport are also influenced by the nature of the sediments themselves—their size, physicochemical, and consolidation properties—and characteristics of the mound. Other factors, such as armoring and biological activity, also play roles in resuspension of mound material.

b. Tides. The astronomical forces of the moon and sun cause tides in the ocean that have both vertical and horizontal motions. These tidal motions, combined with topographic features, give rise to a rotary type of tidal current in the open ocean and along the seacoast. This current varies with locality, depending upon the character of the tide, the water depth, and the configuration of the coast. In any locality, however, these tidal currents repeat themselves as regularly as the tides to which they are related. In the open ocean and wide estuaries, the tidal currents usually rotate due to the effect of the Coriolis force; from hour to hour, the currents change in both direction and magnitude. In narrow estuaries, tidal currents tend to be bidirectional—ebb and flood. In estuarine systems where the tidal prism (volume of water entering from the sea during flood phase of the tide) is large in relation to the daily freshwater runoff, as in the Hudson River estuary and the Chesapeake Bay, currents are oscillatory with pronounced ebb and flood phases. In a few estuaries, notably that of the Mississippi River, riverflow dominates tidal currents with the result that the flow is usually uniformly downstream, showing the tidal effect only in speed and stage variation. Broad, shallow estuaries with small river inflow and small tides, such as the Mobile Bay, are subject to dominant wind-induced unidirectional currents. Depending on estuarine geometry, reversing tidal currents may be strictly bidirectional, with a predominant ebb direction and flood direction and a slack period of near-zero current speed, or they may be rotary, swinging through a range of compass headings during the ebb and flood phases with or without a slack period. Tidal information, including predictions of water levels, tidal ranges, and local datum planes for the coasts of North and South America, is published by the U.S. National Oceanic and Atmospheric Administration National Ocean Survey at <http://tidesonline.nos.noaa.gov/>.

c. Waves. The ability of water waves to transport bottom sediment is related to the magnitude of the shear stress exerted by the wave motion on the bed and dynamic pressure changes under the waves. Oscillatory fluid motion associated with surface gravity waves exerts shear stresses on the bottom that are often several times larger than shear stresses caused by unidirectional currents of the same magnitude because of the pressure fluctuations. Thus, the importance of wave motion in initiating and transporting sediments in a coastal environment is apparent, as the stresses produced by wave motion may put sediments into suspension where they can be transported by currents of a magnitude insufficient to initiate sediment motion.

d. Density gradients. Density gradients caused by differences in dissolved solids content and water temperature impose both vertical and horizontal circulation patterns on the tidal currents. The pattern of stronger upstream currents near the bottom and stronger downstream currents near the surface can lead to net upstream flow in the lower layers of the water column. The pattern can be expressed as a flow predominance (Simmons 1966) that indicates the percentage of flow in either direction at a given point in the water column. Between the downstream predominance of the river and the upstream predominance of the bottom currents in the lower estuary, null areas occur in which there is no net flow predominance in either direction. This, of course, has serious implications for transport of sediments and contaminants through the estuary.

e. Wind. Other significant aspects of estuarine hydrodynamics include wind-induced currents and seiching produced by wind stress. Wind-induced currents have a complex structure that includes generally downwind surface currents and upwind bottom currents in deep channels. These currents may alter sediment transport patterns or, in some cases, may be the primary transport mechanism.

f. Episodic events. The passage of a meteorological event such as a storm or hurricane results in the generation of extreme waves on the ocean surface and, for a semienclosed region such as an estuary or lake, a change in water level and sometimes in currents. These events may result in disturbance of the sediment on the bottom. When dredged material placed at an aquatic disposal site decreases the local depth substantially, its susceptibility to material resuspension and dispersion by storms is increased. Consequently, an upper bound on the amount of material that can be accommodated at any given site (the site capacity) can be set in terms of the degree of dispersion that is acceptable. In order to be able to describe the importance of storms as a source of disturbance of the bottom, it is necessary to have a measure of the frequency of occurrence of storms of different magnitudes affecting the site.

3.3.3.3 Dredged material mound characteristics. Data on the physical properties of existing dredged material mounds are extremely meager (Basco, Bouma, and Dunlap 1974). A considerable amount of information has been collected regarding the chemistry of the material, presumably due to environmental concerns, but these data have very little bearing on the long-term fate of the mound. The physical properties that have been reported are those that were obtained from highly disturbed samples. Undisturbed samples ultimately yield the most information of use in evaluating the long-term fate of an aquatic dredged material mound.

a. Composition. The fate of a dredged material disposal mound is almost entirely a function of the material being deposited because of the minor influx of materials from outside sources. The material in the mound differs from the material at the dredging site, primarily by the amount of fines that has been carried away during deposition. The composition of a disposal mound is also strongly influenced by whether the dredged material comes from a new project or from dredging of existing channels. Commonly, material from new channel dredging is clay that becomes armored with fine silt or shell. During deposition, these artificially formed mud balls, along with the coarser particles, settle first, bringing about an easily observable interface between the natural bottom at the disposal site and the disposal mound. Mounds from maintenance dredging, conversely, are often observed to have a more homogeneous consistency.

b. Location of sites. When consideration is being given to site capacity of nondispersive dredged material disposed in aquatic sites, one condition that should be met is that the site should be located where there is natural deposition or nondisturbance of sediment of a grain size equal to or less than the grain size of the dredged material. With reference to the Long Island Sound, deposition of silt occurs in the central and western basins. The New Haven placement site is located in a region where silt is accumulating at a rate of about 8 g/sq m/year. Eleven other designated placement sites in Long Island Sound are also located in depositional environments, although none are located where the most rapid sedimentation occurs.

c. Original topography of the disposal sites. The topography of an aquatic dredged material mound depends to a great extent on the original topography of the area prior to any placement. If the dredged material is deposited on a sloping bottom, gravitational forces cause material to move downslope and tend to spread the material over larger areas, much as a turbidity current or density flow is known to exist in the continental slope region of the ocean. However, if the material is placed between ridges or in a depression zone, the spreading is inhibited and the overall effect is to smooth the troughs and peaks of the existing undulating bed.

d. Type of placement. The ultimate long-term topography of the mound depends to a great extent on the type of placement. Whether the final bathymetry forms a ridge, cone, or some other formation depends on the precision with which the placement operation is performed. Some placement may occur prior to reaching the placement site or at locations not precisely designated for placement because of imprecise navigation techniques or the desire to minimize dump haul distance. For whatever reason, unless the material is placed as prescribed, the resulting bathymetry of the dredged material mound will be significantly affected.

e. Characteristics of dredged material and existing currents. The characteristics of the dredged material and the existing currents of the area affect the mound topography. Briggs (1970) found that placement in the Upper Chesapeake Bay resulted in material covering an area approximately five times that of the placement area originally selected. The characteristics of the material were such that the maximum slope measured about 1:100 (average slopes were 1:500). Bathymetric surveys at different stages of placement operations in the Rhode Island Sound by Saila, Pratt, and Polgar (1972) showed the maximum slopes of mounds to be about 9:100. If free placement occurs, the slopes of the mounds should be indicative of the shear strength of the materials involved. However, the effect of currents is probably just as important in arriving at the ultimate slope of the aquatic mound.

f. Consolidation. Consolidation is a decrease in thickness of a saturated layer due to the decrease in the void ratio under the action of an effective overburden pressure. The degree of consolidation is important because it can be related to shear strength characteristics of the dredged material disposal mound. Salem and Krizek (1973) determined that dredged material was slightly more compressible than typical inorganic soils, and they noted that at low intensities of loading, the void ratio of some samples actually increased with time rather than decreased. This was attributed to the generation of gases in the material, which tended to counteract the applied load and allowed expansion of the sample. In general, freshly deposited dredged material at an aquatic disposal site is in a highly underconsolidated state. With the passage of time, excess water escapes from the voids, and upon completion of this process, the material is normally



consolidated. If some of the overlying material is subsequently eroded after the mound has become normally consolidated, the remaining material will be in an overconsolidated state as some of the overburden pressure has been removed. Under normal conditions, different portions of a disposal mound may exist in underconsolidation, normal consolidation, and overconsolidation.

g. Biological activity. According to Basco, Bouma, and Dunlap (1974), activity of some burrowing organisms may increase erosion of mounds of dredged material. In contrast, the activity of tube-building animals within the mounds may slow down the rate of erosion. Such animals can cover mounds with dense mats of soft tubes that may protect the dredged material from erosion and even act as traps for fine particles. Thus, the effects of biological activity remain uncertain and uncontrollable.

3.3.3.4 Transport and redeposition of mound material. It is known that resuspension and redeposition of movable material (cohesive or noncohesive) are functionally related to the magnitudes of physical stresses (forces) that induce such movement. If the natural environmental forces existing in the region are less than those forces required for particle motion, the particles will remain at rest. If, however, the available stresses are greater than those required to place material in motion, particle motion will be initiated. Transport will continue until the moving particles enter a water mass where the hydrodynamic forces decrease below those necessary for maintaining transport, at which time the particles will settle from the water column. To analyze the long-term site capacity of an open-water disposal site, it is necessary to know the magnitudes of the physical forces that exist in the region. If this information is unavailable, a suitable, comprehensive field data collection program should be initiated to obtain the necessary data.

a. Transport. Sediment transport consists of three physical processes: sediment particles are entrained into the water column, sediment particles are transported by the motions of the water column, and sediment particles deposit or redeposit on the bed. While the particles are entrained by the water column, motion may exist as either bed load or suspended load. Bed load is defined as the sediment that moves on or in frequent contact with the bottom. Suspended load is that material transported within the water column, maintained above the bottom by the turbulence in the water column. Usually particles entering the suspended load stage are quickly dispersed whereas particles in the bed-load stage travel in spurts for short distances. Complex entrainment-transport-deposition cycles lead to large spatial and temporal variations in sediment distribution within any given estuarine, coastal, or lake environment. The ultimate destination (fate) of suspended sediment particles depends on the particle size and character and the magnitude of the currents and associated turbulence that keeps the particles in suspension. The smaller silt and clay particles have extremely slow settling velocities (less than 0.001 mm/sec) and remain suspended (because of their size and shape) until aggregation into composite particles permits settling. The mode of transport depends on the size, shape, and submerged weight of the sediment particles and the character of flow. Coarse-grained, noncohesive sands (greater than 62 microns) are transported as individual grains, tending to be frequently in contact with the bed. Fine-grained sediment (less than 62 microns) travels mostly in suspension, approaching the bed only when flow intensity is very low or when, in the case of cohesive sediment, individual grains collect into composite particles that settle through the water column. The transport processes of coarse and fine sediments are substantially different.

b. Redeposition. If mound dynamics calculations determine that sediment will be eroded from an open-water disposal site, the destination of that sediment must be determined. A numerical or physical modeling approach to the problem will provide an indication of the amount eroded and the ultimate fate of the resuspended sediment. The use of field observations to determine the fate of resuspended sediment is rather difficult. The depths of deposits are seldom large enough for accurate measurement by standard hydrographic surveying methods. Analytical techniques for predicting the long-term fate of resuspended sediments are extensions of the work used to determine how much sediment leaves the site. Knowledge of hydrodynamic conditions at the site is required to calculate directions and rates of transport out of the site. Hydrodynamic conditions along the projected path may then be predicted so that zones of deposition can be identified. In tidal flows, sediment may deposit temporarily and be resuspended again during strength of flow. Because of the oscillatory nature of the flow, the resuspended sediment may move in and out of the disposal site or may simply oscillate. Describing this process analytically requires a more detailed knowledge of the hydrodynamic conditions at the disposal site than is usually available for an analytic study. Such an effort is often reduced to computing a path, assuming a distribution, and concluding that the redeposited sediment thickness is either negligible or significant.

3.3.4 Numerical models for open-water disposal. Several predictive models listed in Table 3-1 were developed through the Dredged Material Research Program (DMRP) and the Dredging Research Program (DRP) to address short-term fate factors of dredged material disposed in open water. These models are modules in the Automated Dredging and Disposal Alternatives Modeling System (ADDAMS) (Schroeder and Palermo 1990). Developed at the Engineer Research and Development Center (ERDC), ADDAMS is an interactive personal computer-based design and analysis system containing models to assist engineers, planners, and dredging operations managers in predicting the fate and behavior of dredged material. The general goal of ADDAMS is to provide state-of-the-art computer-based tools that will increase the accuracy, reliability, and cost effectiveness of dredged material management activities in a timely manner. To download programs in ADDAMS and for further information, go to <http://el.erdc.usace.army.mil/elmodels/addainfo.html> and look under the title "Dredged Material Disposal Management Models."

3.3.4.1 STFATE. This model simulates the areal distribution of dredged material within the water column and the resulting bathymetric distribution of dredged material from individual placement events from a hopper dredge. It is appropriate for instantaneous discharges from barges or scows and sequential discharges from hopper dredges. The STFATE model was developed from the DIFID (DISposal From an Instantaneous Dump) model, originally prepared by Koh and Chang (1973). STFATE is a module of ADDAMS and can be run on DOS-based IBM-compatible personal computers having 80386 or higher processors with math coprocessors. An executable version of the STFATE model and supporting documentation can be downloaded at <http://el.erdc.usace.army.mil/elmodels/addainfo.html>.

Table 3-1. USACE Short-Term Fate Models

Model	Description
STFATE (Short-Term Fate of dredged material disposed in open water)	Predicts the behavior of dredged material within the minutes and hours following its release from a hopper dredge or barge
MDFATE (Multiple Dump Fate of Dredged Material) <sup>1</sup>	Expands the capabilities of STFATE to predict the dredged material footprint and morphology for multiple disposal events
CDFATE (formerly DROPMIX)	Incorporates the Cornell Mixing Zone Expert System (CORMIX) to predict geometry and dilution characteristics in the near-field mixing zone from surface or near-surface dredged material discharges

<sup>1</sup> MDFATE will be replaced by the Multiple Placement FATE Model (MPFATE).

#### 3.3.4.2 MDFATE Model.

a. MDFATE is a site management tool that expands the capabilities of STFATE. The model simulates the change in bathymetry from multiple disposal events at one site. It is used to predict the creation of navigation hazards, examine site capacity, and conduct long-term site planning. MDFATE uses modified versions of STFATE for simulations. The disposal site bathymetry can be automatically generated (flat or sloping), or actual bathymetric data from an ASCII file can be imported. The suspended solids and conservative tracer portions of STFATE are removed, so the modified STFATE version models the convective descent, dynamic collapse, and passive diffusion process only. A recent addition to MDFATE is a capping module, which simulates the slow release of material from a barge/hopper, so it may spread evenly on the bottom with a minimum amount of momentum imparted to the primary mound. An executable version of the MDFATE model and supporting documentation can be downloaded at <http://el.erdc.usace.army.mil/elmodels/addainfo.html>.

b. A multiple placement model, MPFATE, for representing sedimentation and adjustment of dredged material during placement operations is being developed to improve the numerical representation of short- and long-term processes of dredged material placement in open water for multiple placements and will replace the legacy model, MDFATE. The objective of MPFATE, which will replace the legacy model, MDFATE, is to incorporate improved understanding of sediment processes and dredged material placement practices into a numerical framework that permits dredged material managers to predict interim and final mound configurations at open-water placement sites. Initial development has been focused on improving and extending model capabilities related to assisting the dredged material manager in determining optimum spatial distributions of placement and short-term physical processes. Future development will focus on long-term processes of transport by waves and currents, consolidation, and slope adjustments (avalanching) during placement. Upon completion of MPFATE development, dredged material managers will have a tool capable of providing improved and more reliable information to assist in balancing and optimizing site objectives, such as maximizing site capacity, meeting navigation requirements, and complying with natural resource agency regulations and requirements.

3.3.4.3 CDFATE (formerly DROPMIX). The impact of discharges on the receiving water environment is of central concern in dredging operations. As such, the creation, migration, and

dilution of a discharge plume are of considerable interest as is the size of a required mixing zone for adequate dilution. A mixing zone is a limited volume of water that serves as a zone of initial dilution in the immediate vicinity of the point where material is discharged into the receiving waters. Within this zone, the quality of the receiving waters, once mixed with the discharged effluent, may not meet water quality criteria or standards otherwise applicable to the receiving water. Most states limit the size of the mixing zone and, therefore, the area where water quality standards may be isolated, to as small a size as practical.

3.3.4.4 Cornell Mixing Zone Expert System (CORMIX). Several mathematical models are available for estimating the growth and movement of discharge plumes caused by subaqueous emissions. One of these models, the Cornell Mixing Zone Expert System (CORMIX), was specifically developed to provide a predictive tool for conventional or toxic pollutant discharges into waterways. The CORMIX modeling system was originally developed to address bottom discharges with low suspended solids concentrations or buoyant bottom discharges. Such discharges are typically associated with municipal wastewater, industrial waste outfalls, cooling water, and freshwater releases in saline environments. The CORMIX model focuses on the geometry and dilution characteristics of the initial or near-field mixing zone. The CORMIX modeling system consists of three separate modules: CORMIX1, CORMIX2, and CORMIX3. CORMIX1 is used to examine submerged single-port discharges; CORMIX2 is used to address submerged multiport diffuser discharges; and CORMIX3 is used to analyze surface discharges from channels. Dredged disposal operations, on the other hand, typically involve surface or near-surface discharges with high suspended solids concentrations. Consequently, the existing CORMIX package is not directly applicable to dredged material disposal operations (Chase 1994). However, CORMIX may be used if surface discharges from dredge disposal operations are made equivalent to the mirror image of bottom discharges. This fundamental assumption is the foundation for the Dredging Operations Mixing Zone Model (DROPMIX), now known as CDFATE.

3.3.4.5 CDFATE was developed to adequately address the need for modeling surface or near-surface dredge discharges (Havis 1994). The CDFATE program takes data describing typical dredge discharge activities and uses the CORMIX modeling system (with slightly modified output routines) to predict water column concentrations and dispersion of the plume into the water column resulting from pipeline discharges and other discharges of a continuous nature into waterways. The CDFATE routines transform the dredge discharge information (negatively or neutrally buoyant surface discharge) into an equivalent, mirror-image, positively or neutrally buoyant, bottom discharge scenario with sedimentation. CORMIX analyzes the bottom discharge case to generate information on the mixing zone and turbidity/dissolved contaminant plume. This information includes the location and concentrations of effluent within the receiving waters.

### 3.4 Open-Water Disposal Site Designation/Selection.

3.4.1 Introduction. This paragraph provides an overview of considerations for the identification, evaluation, and selection for final designation of open-water disposal sites. The primary references for this section are the Technical Framework (USEPA/USACE 2004) and the “General Approach to Designation for Ocean Dredged Material Disposal Sites” (USEPA/USACE 1984). Detailed technical guidance on conducting field surveys and analyzing and evaluating site-specific

conditions is presented in Pequegnat, Gallaway, and Wright (1990). Information concerning existing ocean disposal sites can be obtained on the Ocean Disposal Database (ODD) (<http://el.erdc.usace.army.mil/dots/database.html>). The Ocean Disposal Database represents a compilation of ocean dredged material disposal activities that have occurred since 1976 at USEPA-designated sites or sites selected by the USACE. The general approach for ocean site designation presented in this chapter is broadly applicable for open-water disposal under Section 404.

3.4.2 Site selection considerations. Knowledge of site characteristics is necessary for assessments of potential physical impacts and contaminant impacts at open-water sites. The following site characteristics may be needed for assessments:

- a. Currents and wave climate.
- b. Water depth and bathymetry.
- c. Potential changes in circulation patterns or erosion patterns related to refraction of waves around the disposal mound.
- d. Bottom sediment physical characteristics including sediment grain-size differences.
- e. Sediment deposition versus erosion.
- f. Salinity and temperature distributions.
- g. Normal levels and fluctuations of background turbidity.
- h. Chemical and biological characterization of the site and environs (for example, a relative abundance of various habitat types in the vicinity, relative adaptability of the benthos to sediment deposition, presence of submerged aquatic vegetation, and presence of unique, rare, endangered, or isolated populations).
- i. Potential for recolonization of the site.
- j. Previous placement operations.
- k. Availability of suitable equipment for placement at the site.
- l. Ability to monitor the disposal site adequately for management decisions.
- m. Technical capability to implement management options should they appear desirable.
- n. Ability to control placement of the material.
- o. Volumetric capacity of the site.
- p. Other site uses and potential conflicts with other activities (for example, sport or commercial fisheries, shipping lanes, and military use).

- q. Established site management or monitoring requirements.
- r. Public and regulatory acceptability to use of the site.

### 3.4.3 Site designation under the MPRSA.

3.4.3.1 The intent of the criteria for site selection is to avoid unacceptable, adverse impacts on biota and other amenities. This requires that sufficient information be assembled to provide reasonable assurance that the criteria will be met. As a rule, the majority of amenities, such as fishing, shipping, mineral extraction, spawning, breeding, nursery grounds, and cultural or historical features, may be addressed with existing information. If so, primary concern is then directed to biological resources in and adjacent to the proposed disposal site. These concerns are addressed by ensuring that no geographically limited or especially significant living resources are present within or outside the site in such a location as to be adversely impacted by movement of material off the site if it is a dispersive site (USEPA/USACE 1984). Resources within the site may suffer physical impacts from the deposition of the dredged material, and sites should be designated/selected to ensure such that impacts are acceptable.

3.4.3.2 The criteria provide that ocean dumping sites will be designated beyond the edge of the continental shelf, wherever feasible, and at other sites that have been historically used unless monitoring data or other information indicate the potential for significant adverse impacts.

3.4.3.3 If little is known concerning the resources or the characteristics of the site and its environs, appropriate investigations and studies must be performed. The USACE has prepared an ocean-site designation manual (Pequegnat, Gallaway, and Wright 1990), which provides useful guidance and procedures for conducting the appropriate investigations and studies. In addition, overview manuals for site designation have been developed (USACE/USEPA 1984; USEPA 1986).

### 3.4.4 Site specification under CWA.

3.4.4.1 The specification of placement sites under the CWA is addressed specifically in the Section 404(b)(1) Guidelines. The Guidelines establish a sequential review of a proposed project, the first step of which is avoidance of adverse impacts to the aquatic environment through an evaluation of practicable alternatives that would have less impact on that environment (40 CFR 230.10[a]). In general, the same concerns as given above for ocean-site designation are applied to site specification under the CWA: potential impacts on physical and chemical characteristics of the aquatic ecosystem, potential impacts on biological characteristics of the aquatic ecosystem, potential effects on special aquatic sites, and potential effects on human use characteristics (40 CFR 230 Subpart C-F).

3.4.4.2 The specification of an appropriate site under the CWA takes into account that CWA placement sites may be located in estuaries, rivers, and lakes that may have limited assimilative capacity. Geographic and operational constraints as well as site capacity may severely constrain potentially available sites.

3.4.4.3 There are also special concerns if the site is a special aquatic site (for example, a wetland) as defined in Section 404 (40 CFR 230 Subpart E). For example, if the proposed placement site is a special aquatic site and the activity for which placement is required is not water-dependent, the Guidelines presume that nonaquatic alternatives are available (40 CFR 230.10[a][3]).

3.4.4.4 Physical compatibility between the characteristics of the dredged material and proposed placement site is not the sole factor to be used in determining compliance with the Guidelines. Other requirements of the Guidelines, specifically Section 230.10, must also be considered in the evaluation of dredged materials. In addition, under Section 230.11(g), the Guidelines require that the cumulative impact of the individual discharges of dredged material on the aquatic ecosystem be included in the evaluation of individual permits. Therefore, dredged material placement, like all other discharges of dredged or fill material into waters of the United States, cannot be permitted unless it has been demonstrated to comply with all requirements of the CWA Section 404(b)(1) Guidelines.

3.4.4.5 The USACE and the USEPA may jointly identify, in advance, sites generally suitable or unsuitable for discharge of dredged material (40 CFR 230.80). The advanced identification of sites does not permit or prohibit the discharge of dredged or fill material, but does facilitate individual or general permit application and processing. Under the authority of Section 404(c), however, the USEPA may prohibit, withdraw, or restrict the discharge of dredged or fill material if it determines that the discharge would have unacceptable adverse effects.

### 3.4.5 General approach to site designation.

#### 3.4.5.1 Background.

a. A proposed ocean dredged material disposal site must fulfill certain basic requirements if it is to be feasible for use by a USACE district or a permit applicant. The site must be located within an economically feasible distance from the point of dredging. In addition, the site must be established so as to minimize potential harm to critical resources as well as to minimize interference with other beneficial yet incompatible uses of the ocean environment.

b. The designation approach jointly developed by the USEPA and the USACE presented herein (from USEPA/USACE 1984) uses a hierarchical framework that initially establishes the broadest economically and operationally feasible area of consideration for site location. A step-by-step sequence of activities is then conducted to eliminate critical and/or unsuitable subareas.

c. Further evaluation of alternative sites within this area entails various levels of assessment as suggested by the sensitivity and value of critical resources or uses at risk and potential for unreasonable adverse impact presented by the dredged material to be disposed.

d. Site designation criteria are applied to the information assembled through this process, and a final site or sites are selected for designation. This concept is illustrated in Figures 3-7 through 3-9. This site designation study procedure builds upon the basic screening concept discussed by

31 Jul 2015

Pequegnat (1984) and was specifically developed to make maximum use of existing information and data in the site designation process.

3.4.5.2 General process. The site designation study process is structured into three major phases in USEPA/USACE (1984). Phase I includes the delineation of the general area being considered for locating a site and the identification and collection of the necessary information on critical resources and uses and on the physical and environmental processes for the area. Phase II involves the identification of candidate sites within the area based on the information collected and processed in Phase I. Phase III is the evaluation of candidate sites, selection of a recommended site or sites for designation, and the development of a site management plan.

a. Phase I. In this phase (Figure 3-10), the geographic area of consideration must first be defined. Reasonable distance of haul is the determining factor and will be affected by considerations such as available dredging equipment, energy use constraints, costs, and safety considerations. Then, within this zone of siting feasibility (ZSF) (additional details for determining ZSF are provided in USEPA/USACE 1984), a preliminary analysis, based on available data, is applied to identify and map reach boundaries for critical resources as well as zones of incompatibility. Such critical areas and resources may include clustered areas of geographically limited fisheries and shellfisheries, navigation lanes, beaches, and marine sanctuaries. Upon completion of this preliminary analysis, preliminary screening should be conducted, based on the general type of expected dredged material and a general knowledge of physical processes. This screening should delineate bottom areas that may be incompatible with the anticipated sediment to be disposed, such as silt on a sand bottom. In addition, the screening should ensure the establishment of an appropriate buffer zone around each such identified critical area or resource.

b. Phase II. Except in rare cases, the preliminary analysis and screening eliminate critical resources and incompatible areas from further consideration. The remaining areas may be considered as candidate areas for location of an ocean dredged material disposal site or sites. At this point, the selection of alternative sites for further evaluation becomes a matter of informed judgment. During Phase II, issues on site location, critical areas and resources, or other relevant issues should be identified and resolved and a determination made on additional data requirements (Figure 3-10). Candidate sites are identified for further evaluation considering environmental and other factors such as disposal management requirements. Phase II is complete when adequate data and information are available to address the following 11 specific factors (40 CFR 228.6) for each site under consideration. If additional data are required, steps should be initiated immediately to obtain the information.

(1) Geographical position, depth of water, bottom topography, and distance from coast.

(2) Location in relation to breeding, spawning, nursery, feeding, or passage areas of living resources in adult or juvenile phases.

(3) Location in relation to beaches or other amenity areas.



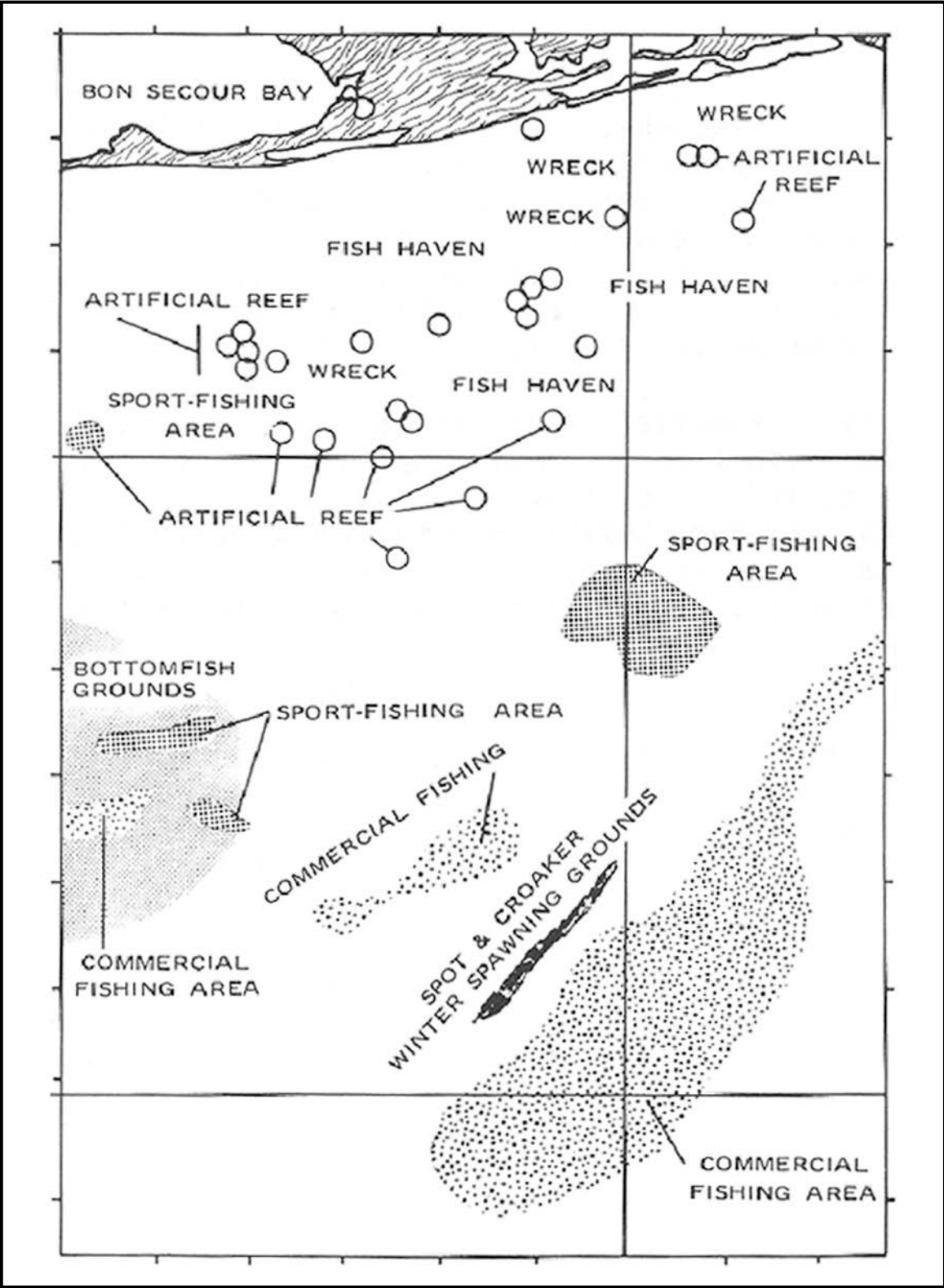

Figure 3-7. Example Plot of Important Marine Resources (after USEPA/USACE 1984)

31 Jul 2015

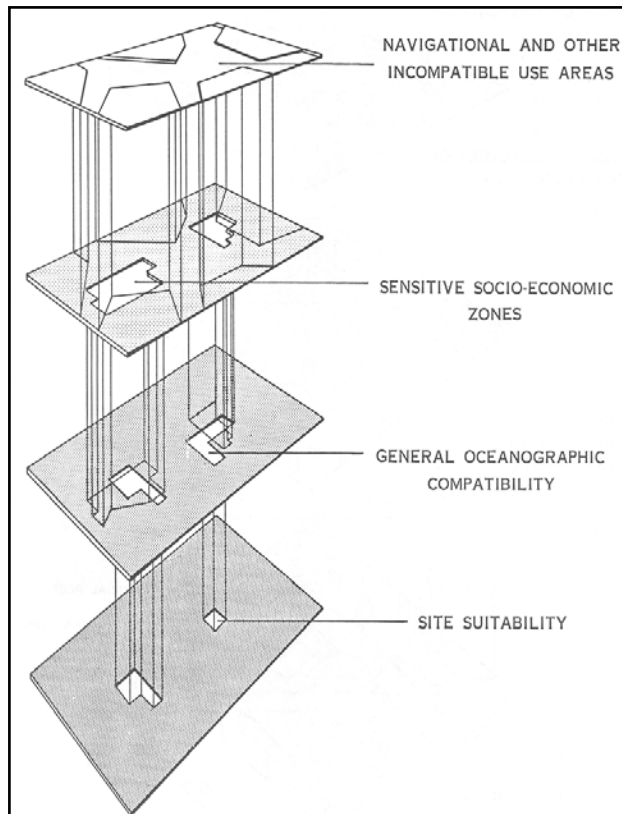

Figure 3-8. General Representation of the Screening Concept for Siting (after USEPA/USACE 1984)

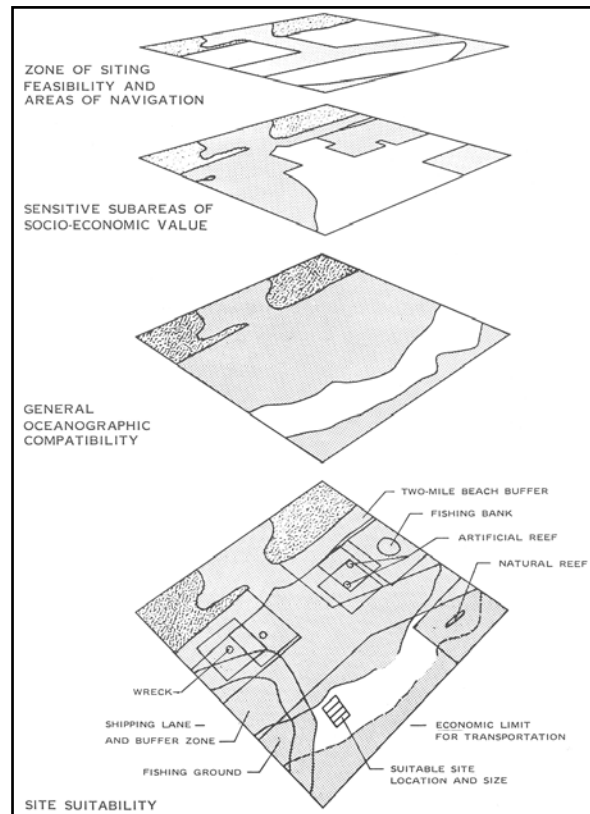

Figure 3-9. Overlay Process for Screening Out Sensitive and Incompatible Use Areas (after USEPA/USACE 1984)

(4) Types and quantities of wastes proposed to be disposed of and proposed methods of release, including methods of packaging the waste, if any.

(5) Feasibility of surveillance and monitoring.

(6) Dispersal, horizontal transport, and vertical mixing characteristics of the area, including prevailing current velocity, if any.

(7) Existence and effects of present or previous discharges and dumping in the area (including cumulative effects).

(8) Interference with shipping, fishing, recreation, mineral extraction, desalination, fish and shellfish culture, areas of special scientific importance, and other legitimate uses of the ocean.

(9) Existing water quality and ecology of the site as determined by available data or by trend assessment or baseline surveys.

(10) Potential for the development or recruitment of nuisance species within the disposal site.

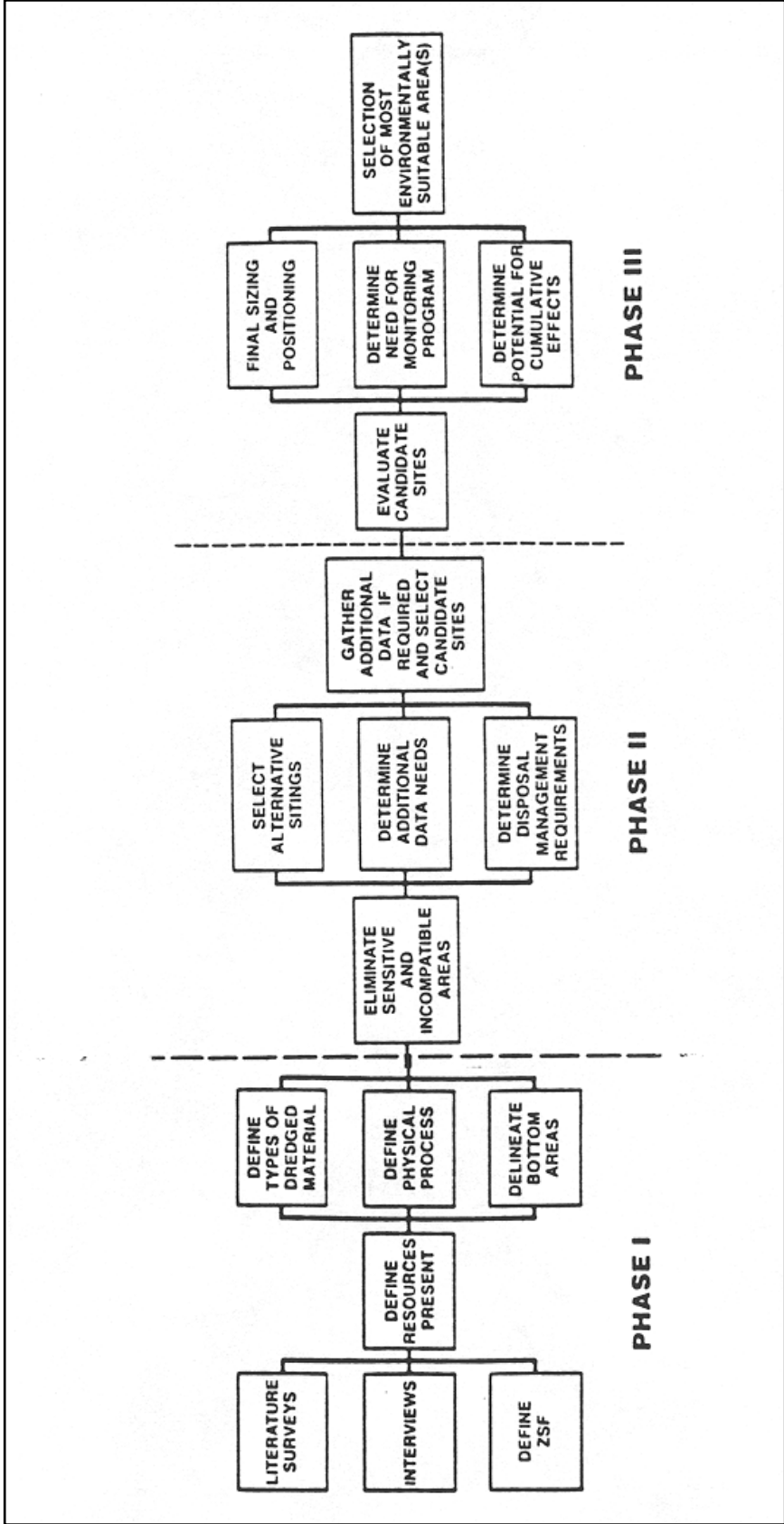

Figure 3-10. Phases of Ocean Dredged Material Disposal Site Designation Protocol (after USEPA/USACE 1984)

(11) Existence at or in close proximity to the site of any significant natural or cultural features of historical importance.

c. Phase III. Phase III consists of the evaluation of the candidate sites and the selection of a site(s) for designation (Figure 3-10). The environmental suitability of each candidate site for designation as an ocean dredged material disposal site will need to be determined. The necessary evaluations are to be based on Section 228.6, “Specific Criteria for Site Selection,” of USEPA/USACE (1984). Using the evaluations under Section 228.6, final determination of the environmental suitability of each candidate site is made in accordance with Section 228.5 of USEPA/USACE (1984).

#### 3.4.5.3 New sites versus existing sites.

a. The process outlined in the preceding paragraphs is specifically structured for the identification and selection for final designation of required new sites for the ocean disposal of dredged material. However, with certain exceptions, this process also applies to designation studies for historically used dredged material disposal sites that the USEPA has designated on an interim basis.

b. The primary objective of designation studies for historically used interim-designated sites is to evaluate the suitability of each such site for continued use. Establishment of the initial geographic zone of consideration (Phase I) for the study should be based on the existing site location and on the estimated zone of potential impact, which considers both existing as well as anticipated future placement requirements for each such site.

c. If this evaluation indicates that the existing site is environmentally acceptable for continued disposal of dredged material, it should be the prime candidate for final designation. However, any possible environmental or operational advantages that might be gained by a relocation of the site should be investigated. If there is no substantive environmental or operational advantage in relocating the site, the final designation of the existing interim-designated site is recommended.

d. In the event that the evaluation—using the 11 specific factors and the following 5 general criteria—shows that the existing site is environmentally unacceptable for continued use, a search for an alternate site or sites should be immediately initiated:

(1) The dumping of materials into the ocean is permitted only at sites or in areas selected to minimize the interference of disposal activities with other activities in the marine environment, particularly avoiding areas of existing fisheries or shell fisheries and regions of heavy commercial or recreational navigation.

(2) Locations and boundaries of disposal sites are chosen so that temporary perturbations in water quality or other environmental conditions during initial mixing caused by disposal operations anywhere within the site can be expected to be reduced to normal ambient seawater levels or to undetectable contaminant concentrations or effects before reaching any beach, shoreline, marine sanctuary, or known geographically limited fishery or shell fishery.

(3) If at any time during or after disposal site evaluation studies, it is determined that existing disposal sites presently approved on an interim basis for ocean dumping do not meet the criteria for site selection set forth in Section 228.5-228.6, the use of such sites is terminated as soon as suitable alternative disposal sites can be designated.

(4) The sizes of ocean disposal sites are limited in order to localize for identification and control any immediate adverse impacts and to permit the implementation of effective monitoring and surveillance programs to prevent adverse long-range impacts. The size, configuration, and location of any disposal site are determined as a part of the disposal site evaluation or designation study.

(5) Wherever feasible, the USACE designates ocean dumping sites beyond the edge of the continental shelf and other such sites that have been historically used.

This search follows the screening and evaluation sequence delineated for new sites.

#### 3.4.5.4 Summary.

a. The foregoing process should lead to a determination of the most environmentally acceptable site. It also may indicate that more than one site is environmentally acceptable. In such cases other factors, like disposal costs and site management requirements, should be analyzed in the final selection of the site(s) to be designated.

b. It is possible the evaluation will determine that none of the candidate sites can be designated without unreasonable adverse environmental impact. If so, the site selection process must be repeated, broadening the initial area of consideration; a decision must be made that ocean disposal is not a feasible disposal alternative; or a decision made to seek a waiver of environmental concerns based on overriding economic considerations (Section 103[d] of the MPRSA).

### 3.5 Evaluation of Direct Physical Effects and Site Capacity.

#### 3.5.1 Direct physical impacts.

3.5.1.1 Direct physical impacts almost always result from the disposal of dredged material. Benthic organisms at the disposal site may be buried and may not be able to migrate through the material. If the substrate is changed from what was previously present, the organisms that recolonize the site may be different from those present prior to disposal. Suspended solids may also affect water column organisms although these effects are uncommon because of the large dilution factor. Both the USACE and the USEPA have generated a large database on potential physical effects through the large number of site designation surveys performed nationwide.

3.5.1.2 Appendix C, "Confined Aquatic Disposal," of this EM provides summaries of the available technical literature concerning impacts to biological resources from physical environmental alterations associated with dredging and dredged material disposal activities. Major classes of disposal-related alterations include suspended sediments, sedimentation, and chemical release. Major categories of biological resources include fishes, shrimps and crabs,

shellfishes (for example, oysters and clams), and benthic assemblages. Potential physical effects are addressed during the site designation/specification process. If at all possible, a site should not be located where significant undesirable effects will occur on or off the site.

### 3.5.2 Site capacity.

#### 3.5.2.1 Background.

a. To manage an open-water dredged material disposal site, it is essential to know the physical capacity of the site (that is, how much material should be dumped at the site and what the capability is of the material to remain onsite under various environmental conditions of waves and currents). Long-term management of aquatic disposal sites also requires an understanding of how much area the dredged material mound encompasses, when the mound encroaches on the site boundaries, how much material leaves the site and, perhaps, where the material ultimately goes.

b. There is no all-encompassing definition of site capacity for open-water sites. However, capacity can be described in terms of physical, chemical, and biological factors. For nondispersive sites, the capacity can be constrained by volumetric limits (filling to a limiting water depth) or by limits on the area of the bottom covered by the material. For dispersive or nondispersive sites, the capacity can be constrained by the ability of the site to dilute solids or contaminants in the water column to acceptable limits, usually within the mixing zone.

c. Evaluations of the physical capacity of predominantly nondispersive sites to hold the dredged material without resuspension and transport of disposed material by surface waves or interference with navigation traffic or other operational conflicts must also be conducted. This evaluation may involve setting a maximum height for mounds of placed dredged material or estimating mounding rates over the long term, taking into account erosion and consolidation of the mound (Dortch et al. 1990; Scheffner 1991; Poindexter-Rollings 1990). Site capacity of predominantly dispersive sites is not normally a concern.

3.5.2.2 Physical aspects. The site conditions (depths, currents, and surface area), physical nature of the dredged material and site (native) material (such as grain size and plasticity), type of dredging operation (mechanical, hopper, or pipeline), and type of discharge determine the dispersive and nondispersive nature of the site and/or govern capping and contained aquatic disposal (CAD) construction requirements. Volumetric limitations (depending on which type of placement alternative is used) depend on aspects such as the portions of material reaching the bottom and remaining in the water column, extent of spread, mixing/dispersion behavior, limiting depth, mounding characteristics, lateral constraint geometry, and long-term material transport from mound by erosive forces. Prior to placement, the physical characteristics of the material should be evaluated to determine if it is compatible with the use of a particular site. Numerical models are frequently used to predict the behavior of the material during and after disposal (see paragraph 3.3.4) and, in some instances, monitoring may be needed to verify the model predictions. The physical capacity of predominantly nondispersive sites to hold dredged material without resuspension and transport of disposed material by surface waves or interference with navigation traffic or other operational conflicts must also be evaluated. This may involve

setting a maximum height for mounds of disposed dredged material or estimating mounding rates over the long term, taking into account erosion and mound consolidation (Dortch et al. 1990; Scheffner 1991; Poindexter-Rollings 1990).

3.5.2.3 Contaminant (chemical) aspects. Chemical considerations (if required) for site capacity center on the question of dredged material contaminant release and toxicity, bioaccumulation, and biomagnification in organisms. The possible migration pathways of contaminants from open-water sites are water column and benthic. Water column contaminant impacts are considered from the standpoint of water quality (chemical) and toxicity (biological) while benthic impacts are considered from the standpoint of toxicity and bioaccumulation. Open-water contaminant testing and assessments are described in more detail in paragraph 3.6. Contaminant control measures may be required to reduce contaminant impact to acceptable levels. These control measures to minimize contaminant impacts may include operational modifications, submerged discharge, lateral confinement, treatment, and capping. They are described in paragraph 3.7.

3.5.2.4 Biological aspects. Biological considerations for site capacity center on changes in abundance, diversity, and organism community structure. These factors can be considered within both the site and the adjacent areas (Section 404) or only within adjacent areas (Section 103). Biological responses due only to the placement of clean material are also considered. Approach for evaluation requires knowledge of biological resources and data from monitoring programs. Guidance on biological considerations in open-water sites is found in Appendix D, "Plant Materials for Beneficial Use Sites."

### 3.6 Evaluation of Contaminant Pathways from Open-Water Disposal.

3.6.1 Purpose. The main emphasis of contaminant pathway testing for open-water disposal is aimed at determining if a given dredged material is acceptable for open-water disposal from the standpoint of contamination. This section of the EM describes the pathways associated with open-water placement and briefly describes the procedures for contaminant pathway testing and evaluation. USEPA/USACE (1991) (Evaluation of Dredged Material Proposed for Ocean Disposal Testing Manual, referred to as the Ocean Testing Manual [OTM]) and USEPA/USACE (1998) (Evaluation of Dredged Material Proposed for Discharge in Waters of the U.S. - Testing Manual, referred to as the Inland Testing Manual [ITM]) contain detailed testing procedures and protocols for open-water placement, so these detailed testing procedures are not repeated in this EM. Both documents are available at <http://el.ercd.usace.army.mil/dots/guidance.html>.

#### 3.6.2 Description of open-water contaminant pathways.

3.6.2.1 As shown in Figure 3-11, the potential contaminant pathways for open-water disposal are water column and benthic. Water-column contaminant impacts must be considered from the standpoint of water quality (chemical) and toxicity (biological). Benthic impacts must be considered from the standpoint of toxicity and bioaccumulation, which is the accumulation of contaminants in the tissues of organisms through any route, including respiration, ingestion, or direct contact with contaminated water, sediment, or dredged material.

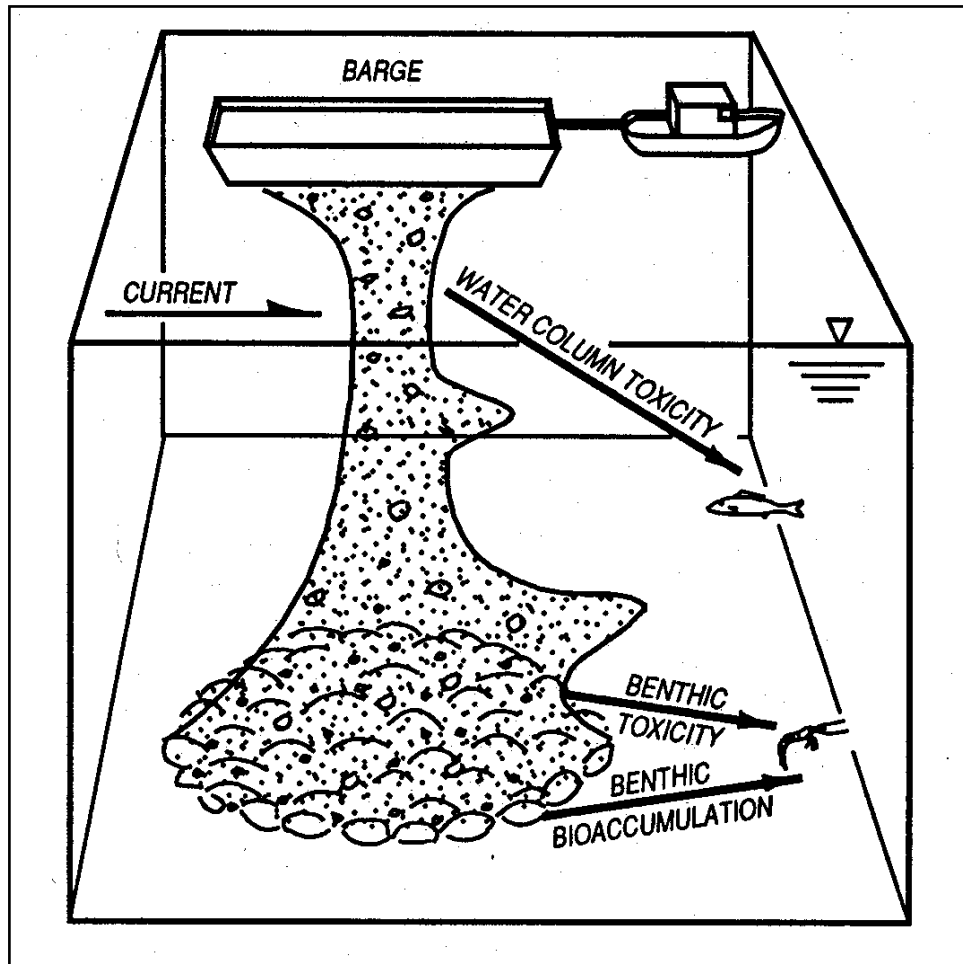

Figure 3-11. Potential Contaminant Pathways for Open-Water Disposal

3.6.2.2 Potential water column contaminant effects are evaluated by comparing contaminant release in an elutriate of the material to be disposed with applicable water quality criteria or standards as appropriate. In addition, acute water column toxicity bioassays considering initial mixing may be needed. For disposal operations under the MPRSA, specific criteria for water quality and water column toxicity must be met, and specific allowances are specified for initial mixing. For disposal operations under the CWA, water quality and water column toxicity standards and allowances for initial mixing are specified by the States as a part of the Section 401 water-quality certification requirements.

3.6.2.3 A number of control measures are available to minimize impacts of losses by these pathways (see paragraph 3.7). A technical framework (USACE/USEPA 2004; Francingues et al. 1985) has been developed that identifies standardized testing procedures for dredged materials to determine appropriate disposal controls.



### 3.6.3 Tiered testing and evaluation.

3.6.3.1 A tiered approach to open-water contaminant testing and assessments is described in detail in the OTM and ITM. This approach is designed to aid in generating necessary toxicity and bioaccumulation information, but not more information than is necessary. This allows optimal use of resources by focusing the least effort on dredging operations where the potential (or lack thereof) for unacceptable adverse impact is clear, and expending the most effort on operations requiring more extensive investigation to determine the potential (or lack thereof) for impact.

3.6.3.2 To achieve this objective, the procedures in these manuals are arranged in a series of tiers, or levels of intensity of investigation. The initial tier uses readily available information that may be sufficient for evaluation in some cases. Dredging operations that obviously have low environmental impact generally should not require intensive investigation to reach a decision and may be excluded from any further testing or evaluation for contaminant-related impacts. Evaluation at successive tiers is based on more extensive and specific information that may be more time-consuming and expensive to generate, but that allows more and more comprehensive evaluations of the potential for environmental effects. A tiered, or hierarchical, approach to testing and evaluation allows the use of a necessary and sufficient level of testing for each specific dredging operation. Overviews of the tiered testing and evaluation procedures used in the OTM and ITM are presented in the two following sections.

3.6.4 Inland Testing Manual (ITM) tiered testing and evaluation overview. The ITM uses a tiered testing approach as shown in Figure 3-12 and described below.

#### 3.6.4.1 Tier I.

a. Tier I involves an examination of existing information to determine whether or not there is reason to believe that the dredged material needs to be tested for potential adverse effects, and to identify any contaminants of concern relative to testing in later tiers. Material may be excluded from further testing if there is reasonable assurance that it is not a carrier of contaminants, or it is adjacent and similar to the disposal site material, and dispersal of the discharge can be controlled. Some limited testing may be necessary to confirm such exclusions.

b. If an evaluation of the dredging site indicates that the dredged material is not a “carrier of contaminants,” testing may not be necessary. Such situations are most likely to arise if the dredged material is composed primarily of sand, gravel, and/or inert materials; the sediments are from locations far removed from sources of contaminants; or the sediments are from depths deposited in preindustrial times and not exposed to modern sources of pollution. However, potential impacts from natural mineral deposits must also be considered.

c. Testing may also not be necessary “where the discharge site is adjacent to the excavation site and subject to the same sources of contaminants, and materials at the two sites are substantially similar” (Section 230.60[c]). However, some physical and chemical testing may be necessary to confirm that the two sites are “substantially similar.” The rationale behind this exclusion from testing is that when the discharge and excavation sites are adjacent, the concentration of contaminants in the two sites is not substantially different, and the geochemical

environments are similar, then the bioavailability of contaminants at the two sites is likely to be similar. This exclusion can apply even if the dredged material is a carrier of contaminants, providing that “dissolved materials and suspended particulates can be controlled to prevent carrying pollutants to less contaminated areas.”

3.6.4.2 Tier II. Tier II is concerned solely with sediment and water chemistry. Tier II provides useful information through screening tools, but not all possible determinations can be reached at this tier. It presently consists of measuring dissolved contaminants, evaluating State Water Quality Standard (WQS) compliance using a numerical mixing model, and evaluating theoretical bioaccumulation potential for nonpolar organic chemicals.

a. Water column impact. There are two approaches for the Tier II water column evaluation for WQS compliance. One approach is to use the numerical models as a screen, assuming that all of the contaminants in the dredged material are released into the water column during the disposal process. The other approach applies the same model with results from chemical analysis of the elutriate test.

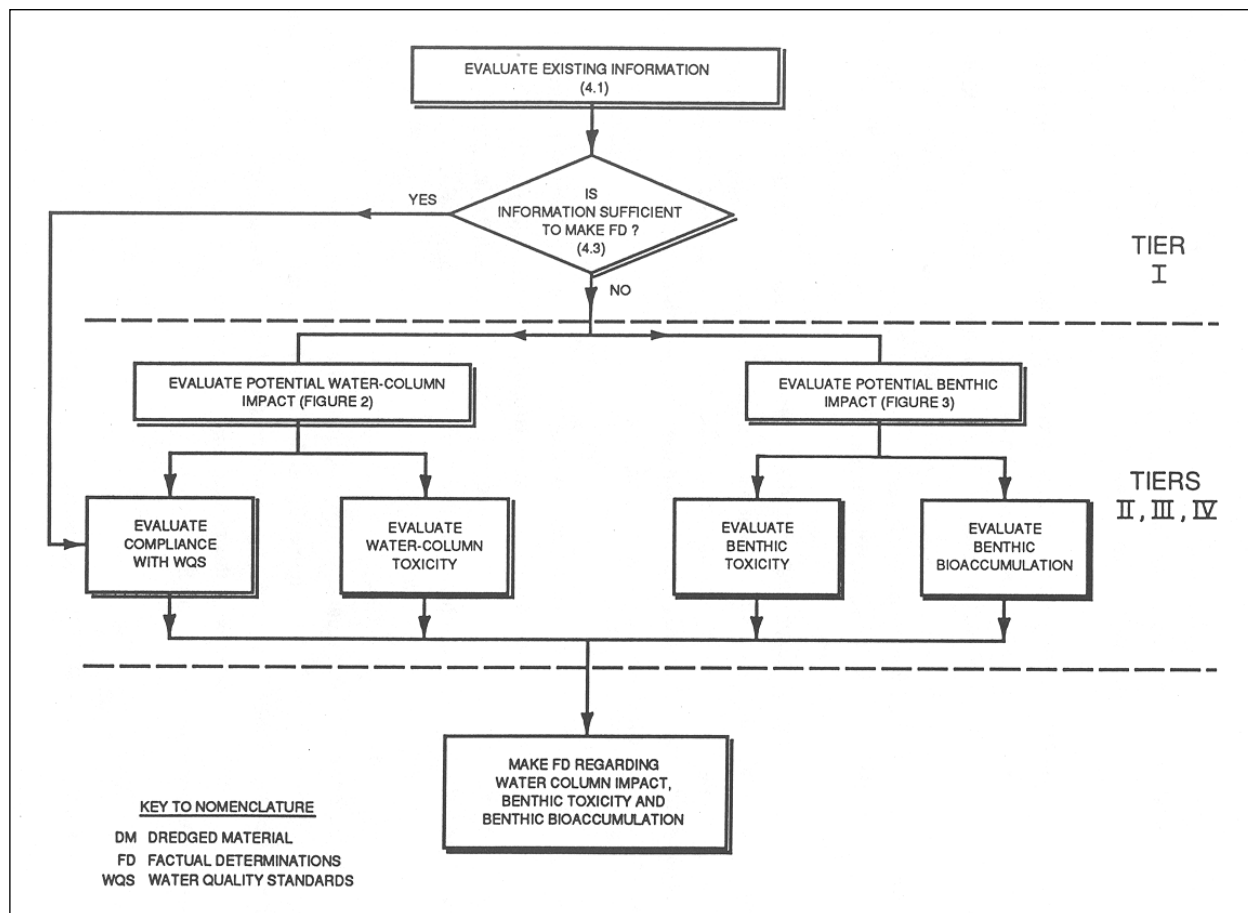

Figure 3-12. Overview of the ITM Tiered Testing Approach

(1) Numerical and model screening. Whenever contaminant concentrations in a dredged material discharge are above WQS, there is some limited initial mixing zone (or zone of dilution) in the vicinity of the discharge point where receiving water quality standards may be exceeded. The Guidelines recognize that it is not possible to set universal standards for the acceptable size of mixing zones since receiving water conditions vary so much from one location to another. The Guidelines therefore instruct that, as part of the dredging permit process, the size of any proposed mixing zone should be estimated and submitted to the permitting authority. The permitting authority must then consider receiving water conditions at the proposed site and decide if the proposed mixing zone size is acceptable. Many State regulatory agencies may specify a limit to mixing zone dimensions as a condition in granting the State water quality certification. In this case the mixing zone necessary to meet applicable standards must be smaller than the specified limits. The size of a mixing zone depends on a number of factors including the contaminant or dredged material concentrations in the discharge; concentrations in the receiving water; the applicable water quality standards; discharge density and flow rate; receiving water flow rate and turbulence; geometry of the discharge vessel, pipeline, or outlet structure; and the receiving water boundaries. Since the maximum allowable mixing zone specified by regulatory agencies is usually on the order of hundreds of meters, the evaluation of mixing zone sizes must necessarily be based on calculation of near-field dilution and dispersion processes. There are a variety of possible estimation techniques for most real mixing zone problems, but any choice of a suitable technique involves some tradeoffs. The available techniques may be thought of as ranging from sophisticated computer models, which are sometimes capable of very accurate predictions, to simple approximations that yield order-of-magnitude estimates. The ITM lists a summary of discharge types, hydrodynamic conditions, and applicable models and methods for evaluation of initial mixing. The STFATE program for barge and hopper discharge and information on the CORMIX program are described in paragraph 3.3.4.4.

(2) Elutriate testing. For an elutriate analysis, a numerical mixing model is run with chemical data obtained from an elutriate test conducted on the dredged material. Elutriate tests involve mixing dredged material with dredging site water and allowing the mixture to settle. The portion of the dredged material that is considered to have the potential to impact the water column is the supernatant remaining after undisturbed settling and centrifugation. Chemical analysis of the elutriate allows a direct comparison, after allowance for mixing, to the applicable WQS. The standard elutriate analysis and the analytical procedures for measuring constituents in the water are provided in the ITM.

b. Benthic impact. The currently available Tier II procedure for evaluating potential benthic impact consists of evaluating the Theoretical Bioaccumulation Potential (TBP) of Nonpolar Organic Chemicals calculated according to the guidance provided in the ITM. The TBP is an approximation of the equilibrium concentration in tissues if the dredged material in question were the only source of contaminant to the organisms. The TBP calculation in Tier II is applied as a coarse screen to predict the magnitude of bioaccumulation likely to be associated with nonpolar organic contaminants in the dredged material.

3.6.4.3 Tier III. Tier III employs well-defined, nationally accepted bioassays including water column laboratory toxicity tests, whole sediment laboratory toxicity tests, and whole sediment bioaccumulation tests. Appropriately sensitive organisms are recommended, including

benchmark species for evaluating the sensitivity of regional species. Summaries of test conditions and test acceptability criteria for all recommended bioassay species are also provided. Toxicity testing emphasizes acute responses, generally survival. Water column toxicity evaluations consider mixing of the dredged material at the discharge site. Benthic bioaccumulation testing provides for the determination of bioavailability through 28-day exposure tests. Tier III testing usually provides sufficient information for use in the overall decision-making process for compliance with the Guidelines.

a. Water column toxicity tests. Tier III considers the effects on water column organisms, after allowance for mixing, of dissolved contaminants plus those associated with suspended particulates. The toxicity and mixing data results are generated as described in the ITM.

b. Benthic toxicity tests. Evaluation of benthic (sediment) toxicity tests in Tier III is based on data generated according to the guidance in the ITM. Dredged material is predicted to be acutely toxic to benthic organisms when mean test organism mortality is statistically greater than in the reference sediment and exceeds mortality (or other appropriate end point) in the reference sediment by at least 10%. Reference sediment is defined as a sediment, substantially free of contaminants, that is as similar as practicable to the grain size of the dredged material and the sediment at the disposal site, and that reflects the conditions that would exist in the vicinity of the disposal site had no dredged material disposal ever taken place, but had all other influences on sediment condition taken place.

c. Benthic bioaccumulation. Body burdens of chemicals are of concern for both ecological and human health reasons. The Tier III benthic bioaccumulation tests are conducted for a subset of the contaminant of concern list based on the contaminant bioaccumulation properties discussed in the ITM. These tests provide for the determination of bioavailability through 28-day exposure tests. For purposes of comparison with an action or tolerance level such as from the Food and Drug Administration (FDA), the duration of a bioaccumulation test should be sufficient for organisms to reach steady-state tissue residues for all compounds.

3.6.4.4 Tier IV. Tier IV is used only in certain cases, where results from tests in earlier tiers are insufficient to determine the potential adverse effects of the material to be discharged. Tier IV, like Tier III, uses toxicity and bioaccumulation tests. However, toxicity tests may involve field (rather than laboratory) exposures, different end points (for example, chronic rather than acute), different species, or longer laboratory exposures. Bioaccumulation tests may involve field (rather than laboratory) exposures using transplanted or resident organisms, or longer laboratory exposures. Tier IV can also include benthos studies.

3.6.5 Ocean Disposal Testing Manual tiered testing and evaluation overview. The OTM uses a tiered testing approach, shown in Figure 3-13, similar to that of the ITM. This procedure also comprises four tiers (levels) of increasing investigative intensity that generate information to assist in making ocean disposal decisions. Tiers I and II use existing or easily acquired information and apply relatively inexpensive and rapid tests to predict environmental effects. Tiers III and IV contain biological evaluations that are more intensive and require field sampling, laboratory testing, and rigorous data analysis.

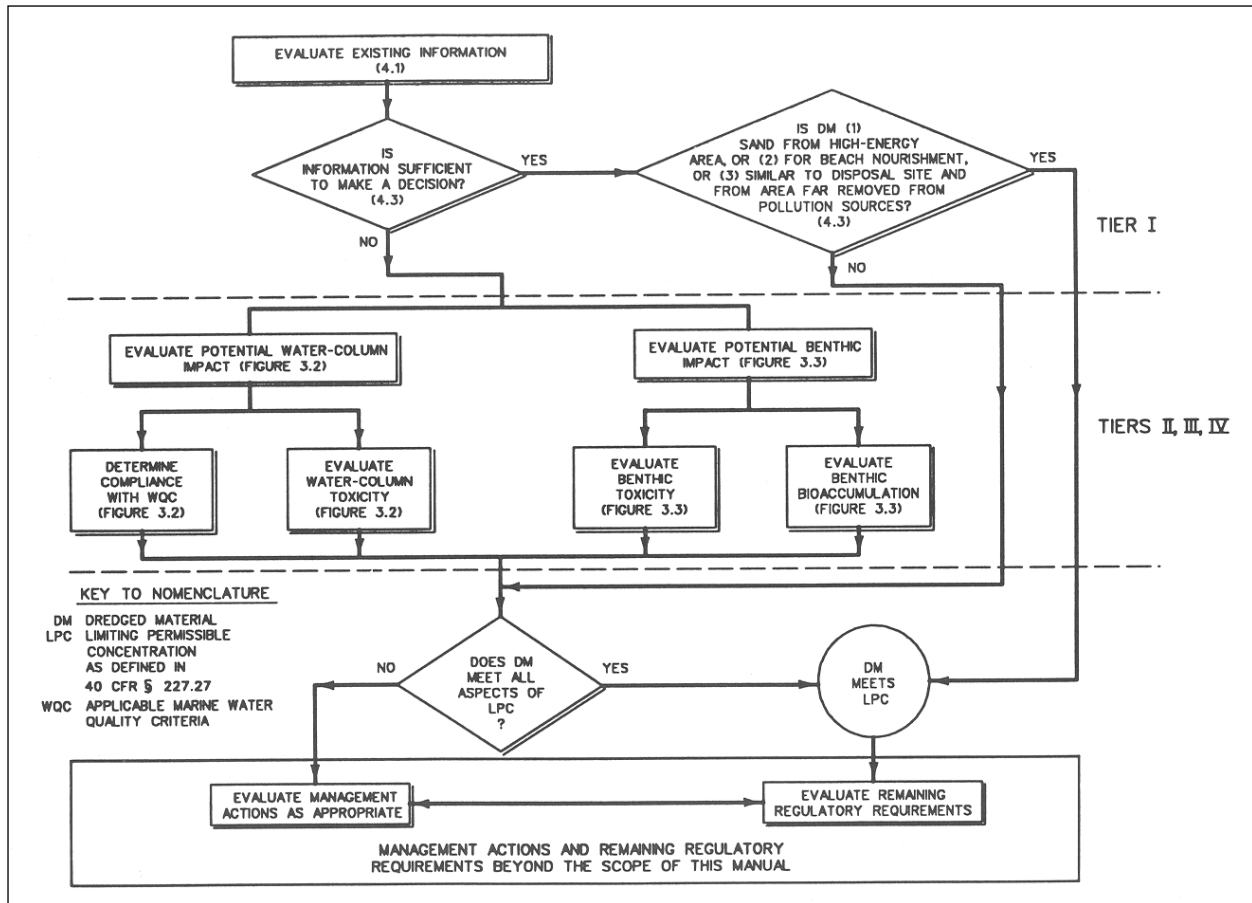

Figure 3-13. Overview of the OTM Tiered Testing Approach

3.6.5.1 The tiered approach and testing evaluations of the OTM and ITM are similar, but integral to the OTM's tiered testing procedure for evaluating compliance is the Limiting Permissible Concentration (LPC) as defined by the ocean dumping regulations. The LPC for the liquid-phase concentration of dredged material in the water column is the concentration that, after allowance for initial mixing, does not exceed applicable marine water quality criteria or a toxicity threshold of 0.01 of the acutely toxic concentration. The LPC of the suspended particulate and solid phases is the concentration that will not cause unreasonable toxicity or bioaccumulation.

3.6.5.2 Potential ocean water column contaminant effects are evaluated by comparing contaminant release of the material to be disposed in an elutriate with applicable water quality criteria or standards as appropriate. In addition, acute water column toxicity bioassays considering initial mixing may be needed. For disposal operations under the MPRSA (compared to the CWA and ITM), applicable marine water quality criteria for water quality and water column toxicity must be met, and specific allowances are specified for initial mixing. For disposal operations under the CWA, water quality and water column toxicity standards and allowances for initial mixing are specified by the States as a part of the Section 401 water quality certification requirements.

3.6.5.3 In assessing potential benthic effects of contaminants under the MPRSA, if the exclusion criteria of 40 CFR 227.13(b) are met, biological testing of the dredged material is not necessary. If the exclusion criteria are not met, toxicity and bioaccumulation information is required to evaluate the suitability of the material for disposal. As described above, if disposal is under the authority of the CWA, a chemical comparison of the material to be disposed and a reference sediment may be conducted.

### 3.7 Water Column and Benthic Control Measures for Open-Water Disposal.

#### 3.7.1 Introduction.

3.7.1.1 In cases where evaluations of direct physical impacts, site capacity, or contaminant pathways indicate that the Criteria or Guidelines will not be met when conventional open-water disposal techniques are used, a variety of management actions and contaminant control measures may be considered. Such control measures include operational modifications and water column and benthic controls. Descriptions of the commonly used management actions and contaminant controls are given in this paragraph.

3.7.1.2 The primary consideration in selecting management or control options is to identify the impacts to be addressed by the management or control options and choose an option that best addresses the issue(s) of concern. The management and contaminant controls discussed in this section are to be considered and implemented on both a site-specific and case-specific basis. General considerations for each option are presented within this section. It is important to note that not all options work under all situations or in all cases. Before any option is selected for implementation, a thorough review of the material-specific and site-specific conditions and circumstances should be completed.

3.7.2 Modification of dredging and disposal operations. Modifications of dredging and disposal operations can be an effective control for both physical effects and water column or benthic contaminant pathways. For purposes of this paragraph, the term “contaminated” refers to material for which isolation from the water column and benthic environment is appropriate because of potential contaminant effects, while the term “clean” refers to material found to be acceptable for open-water placement. The purpose of operational modification as a control is to reduce water column dispersion and/or spread of material along the bottom. The most obvious control measure for open-water disposal is a modification in the technique or equipment used for placement. For example, if water column concentrations of dredged material exceed water quality criteria or toxicity criteria for a proposed hopper dredge discharge, an operational modification to clamshell dredging with discharge from barges would reduce the water column release. Discharge of mechanically dredged material from barges also results in less spread of material than with hopper discharge. Other operational modifications include constraints on location of disposal, rate of disposal, and timing of disposal.

3.7.3 Water column controls. This paragraph describes methods (controls) for reducing dispersion of dredged material in the water column for pipeline discharges, including pipeline configuration, subaqueous discharge with the addition of diffusers, and tremie technology.

### 3.7.3.1 Pipeline configuration at discharge.

a. Probably the most promising method for controlling the dispersion of dredged material slurry at open-water pipeline disposal operations involves modifying the pipeline configuration at the discharge point. Of all the environmental and operational factors affecting the dispersion of dredged material slurry during open-water pipeline disposal operations, the configuration of the pipeline at the discharge point appears to be the only parameter that, from a practical point of view, can be varied to control the characteristics of dispersion effectively. The pattern of dredged material dispersal is apparently controlled by the configuration of the pipeline at the discharge point as well as the angle and height of the discharge relative to the water surface (for above-water discharge) or bottom (for submerged discharge) (see Figure 3-6).

b. Generally speaking, pipeline configurations that minimize water column turbidity tend to produce fluid mud mounds with steep side slopes, maximum thickness, and minimal areal coverage. Conversely, those configurations that generate maximum levels of water column turbidity produce relatively thin fluid mud mounds of maximum areal extent. As the mound height decreases, the amount of wave-induced resuspension of the surface material also decreases. This relationship between mound height and areal extent/resuspension potential should be considered when evaluating the potential short- and long-term impact of a particular disposal operation. Unfortunately, there is no “best” pipeline configuration; the design chosen should be based on the desired dispersal of dredged material in the water column and on the bottom. Several typical discharge configurations are listed in Table 3-2, and their dispersal characteristics are described below.

Table 3-2. Effect of Pipeline Configuration on Dredged Material Dispersion  
(from Barnard 1978)

Typical Pipeline Configurations <sup>1</sup>	Water Column Turbidity		Fluid Mud Mound			
	Surface	Mid-Depth	Height	Slope	Area Covered	Consolidation Rate
Diffuser – submerged	Low	Low	High	High	Low	Low
90° Elbow with Conical Expansion Section (submerged)	Low	Low/ Medium	↓	↓	↓	↓
90° Elbow (submerged)	Low	Medium				
90° Elbow with Splashplate	Low	High				
0° with Splashplate (submerged)	Medium	High				
0° with Splashplate (above)	Medium	High				
20° Open End (submerged)	Medium	High				
0° Open End (submerged)	High	High				
0° Open End (above)	High	High				
			Low	Low	High	High

<sup>1</sup> The pipeline angle relative to the water surface.

(1) The high-momentum levels of a simple open-ended pipeline discharging slurry at 4-6 m/sec (13-20 ft/sec) parallel to the water surface cause a great deal of sediment entrainment into the disposal site water as the slurry jet descends through the water column and impacts on the bottom. Turbidity levels are generally high and the fluid mud layer is relatively thin and widely dispersed.

(2) Submerging the discharge just below the water surface may reduce the degree of slurry dispersion; however, based on the field data, it is difficult to determine how significant this reduction may be. If the discharge pipe is submerged to a sufficient depth below the surface, a visible plume may not be apparent.

(3) Mounting a deflector or splashplate at the end of the pipe perpendicular to the slurry flow creates low discharge angles that can significantly reduce the slurry momentum. Although this modification tends to disperse the slurry as it is discharged, the momentum loss is apparently significant enough to cause the dispersed slurry to settle to the bottom relatively quickly, thereby generating less water column turbidity.

(4) Increasing the angle of the pipeline from 0° to 90° decreases the amount of water column turbidity generated by a simple submerged discharge. With a simple 90° elbow on the end of the pipeline, the slurry is discharged vertically toward the bottom with less entrainment of disposal site water. Upon impact of the slurry at the bottom, its vertical motion is translated into a horizontal flow, which spreads radially from the impact point. In areas where current velocities are less than 10 cm/sec (4 in/sec), this configuration produces near-surface turbidity plumes that are very diffuse, with occasional “puddles” of higher solids concentrations at varying distances from the discharge point.

(5) Adding a splashplate to the simple 90° elbow can increase the amount of slurry. With the end of a 69 cm (27 in) pipeline discharging at a depth of 1 m (3.3 ft) against a splashplate positioned at a depth of 2 m (6.6 ft), the slurry is dispersed at the depth of the splashplate with traces of surface turbidity visible only within 100 m (328 ft) of the discharge point.

(6) Adding a 15° conical section at the end of the simple 90° elbow can reduce the effective velocity of the discharge slurry by a factor of 2 or 3 without affecting the production rate of the dredge. This reduction in slurry velocity tends to decrease the levels of water column turbidity and increase the mounding tendency of the fluid mud.

#### 3.7.3.2 Submerged discharge.

a. If the placement of the contaminated sediment with surface discharge results in unacceptable water column impacts, or if the anticipated degree of spreading and water column dispersion for either the contaminated or capping material is unacceptable, submerged discharge is a potential control measure. It is noted that discharge above water (into air) significantly increases near-surface turbidity generation (Neal, Henry, and Greene 1978). In the case of contaminated dredged material, submerged discharge serves to isolate the material from the water column during at least part of its descent. This isolation can minimize potential chemical releases due to water column dispersion and significantly reduce entrainment of site water, thereby reducing bottom spread and the area and volume to be capped. In the case of capping material, the use of



submerged discharge provides additional control and accuracy during placement, thereby potentially reducing the volume of capping material required.

b. The use of a submerged discharge or closed conduit of some type to place dredged material is a second level of control available. In general, a conduit is used primarily to ensure more accurate placement of the material and to reduce the exit velocity during formation of the surge phase. A conduit extending from the surface to the bottom isolates the material from the water column during descent, reduces entrainment, and negates the effects of currents and stratifications. A conduit is a conservative measure that should be used to overcome placement problems or in situations where the moisture content of the material is such that it would tend to flow on impact rather than mound.

c. Limited data suggest that both above-water or submerged discharges perpendicular to the water surface have lower near-surface turbidity than horizontal discharges or discharges at some angle (Schubel and Carter 1978; Neal, Henry, and Greene 1978). Discharge detector plates help reduce near-surface turbidity for a horizontal discharge (Schubel and Carter 1978; Neal, Henry, and Greene 1978).

### 3.7.3.3 Submerged diffuser.

a. A submerged diffuser (Figures 3-14 and 3-15) can be used to provide additional control for submerged pipeline discharge to reduce discharge velocity, entrainment, and turbulence. It consists of conical and radial sections joined to form the diffuser assembly, which is mounted to the end of the discharge pipeline. A small discharge barge is required to position the diffuser and pipeline vertically in the water column. Positioning the diffuser several feet above the bottom isolates the discharge from the upper water column. The diffuser design allows material to be radially discharged parallel to the bottom and with a reduced velocity. The diffuser can also be used with any hydraulic pipeline operation, including hydraulic pipeline dredges, pump-out from hopper dredges, and reslurried pump-out from barges.

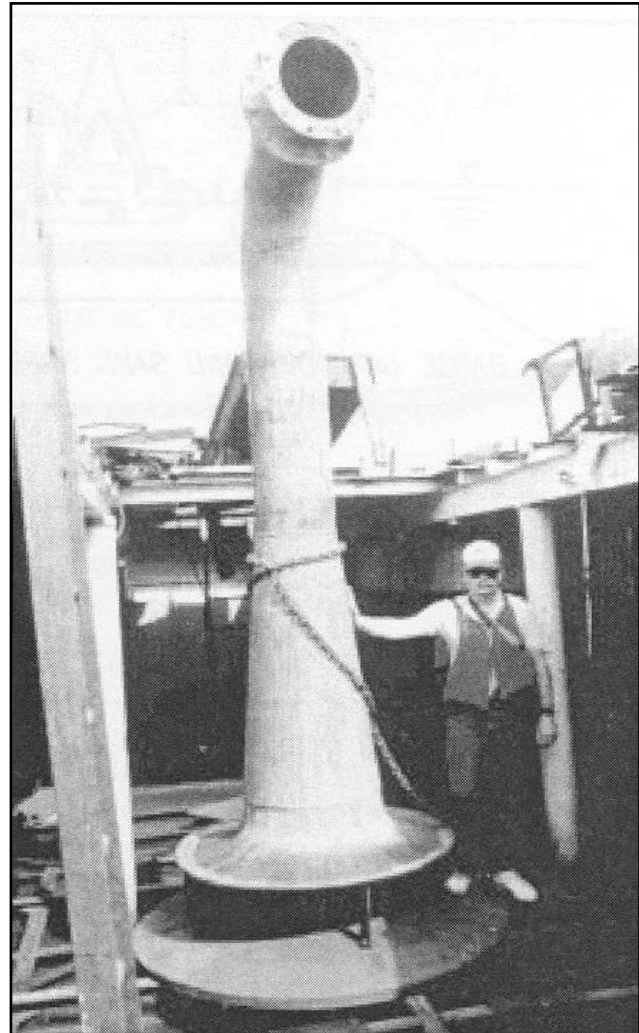

Figure 3-14. Submerged Diffuser

31 Jul 2015

b. A design for a submerged diffuser system was developed by JBF Corporation as a part of the Dredged material Research Program (DMRP) (Barnard 1978; Neal, Henry, and Greene 1978). This design consists of a funnel-shaped diffuser, oriented vertically at the end of a submerged pipeline section, which radially discharges the slurry. The diffuser and pipe section is attached to a pivot boom system on a discharge barge. Design specifications for this submerged diffuser system are available in Neal, Henry, and Greene (1978). The design consists of routing the flow through a vertically oriented  $15^\circ$  axial diffuser with a cross-sectional area ratio of 4:1 followed by a combined turning and radial diffuser section that increases the overall area ratio to 16:1. Therefore, the flow velocity of the slurry prior to discharge is reduced by a factor of 16, yet the dredge discharge rate (slurry flow velocity  $\times$  the pipeline cross-sectional area) is not affected in any way by the diffuser. The conical and turning/radial diffuser sections are oriented to form the diffuser assembly, which is flange mounted to the discharge pipeline. An abrasion-resistant impingement plate is supported from the diffuser assembly by four to six struts. The parallel conical surfaces of the radial diffuser and impingement plate slope downward at an angle of  $10^\circ$  from the horizontal so that stones and debris can roll down the sloped surface and automatically clear the diffuser (Figure 3-15).

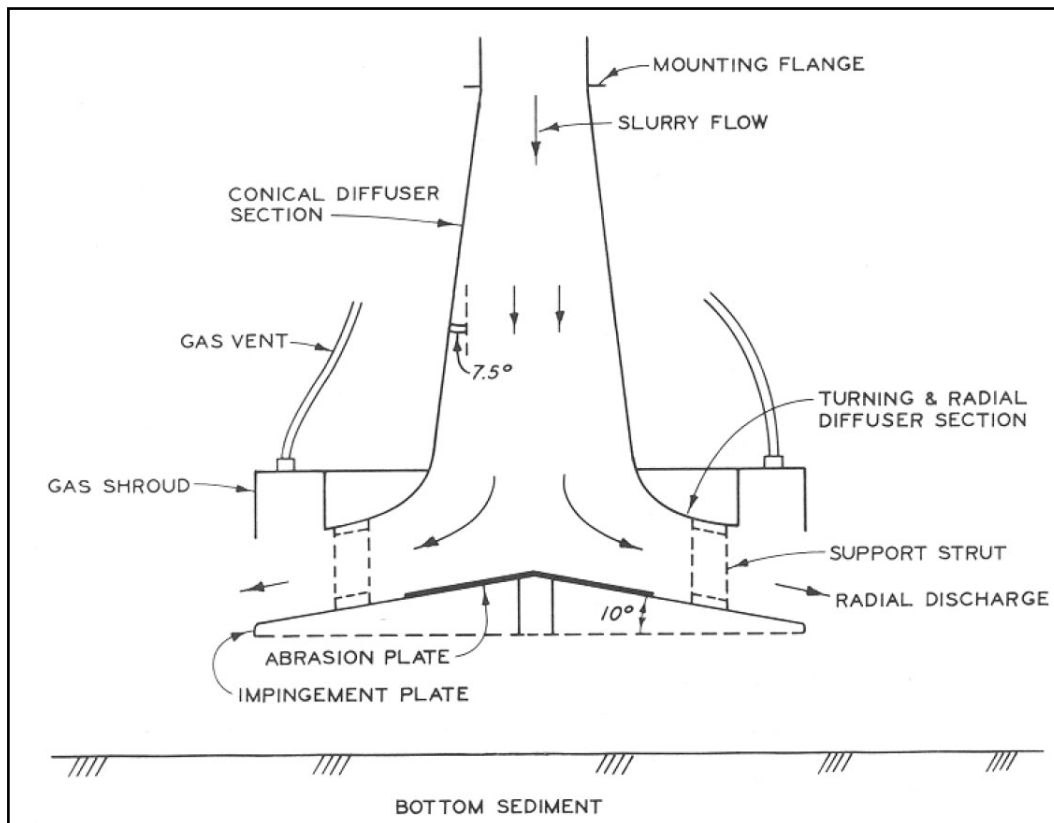

Figure 3-15. Submerged Diffuser Profile View

c. The radial discharge area of the diffuser can be adjusted by changing the length of the struts supporting the impingement plant. In this manner both the thickness and velocity of the discharged slurry can be controlled. The strut length, which determines not only the slurry discharge velocity, but also the maximum diameter of an object that will pass through the

diffuser, should be approximately five-sixths of the pipe diameter. Since the gas content of bottom sediment is often high (5-30% of the in situ volume), the diffuser is also equipped with a gas collection shroud around the circumference of the radial diffuser section to trap any sediment-covered gas bubbles before the slurry is discharged. The gas is vented to the atmosphere through a hose extending from the shroud to the top of the derrick. The diffuser for a 45 cm (18 in) pipeline is approximately 1.8 m (6 ft) tall from impingement plate to mounting flange and 2.4 m (8 ft) in diameter at its base.

d. A discharge barge must be used in conjunction with the diffuser to provide both support and the capability for lowering the diffuser (Figure 3-16). The barge also provides a platform for the diffuser while it is being adjusted, service, or moved to a new site.

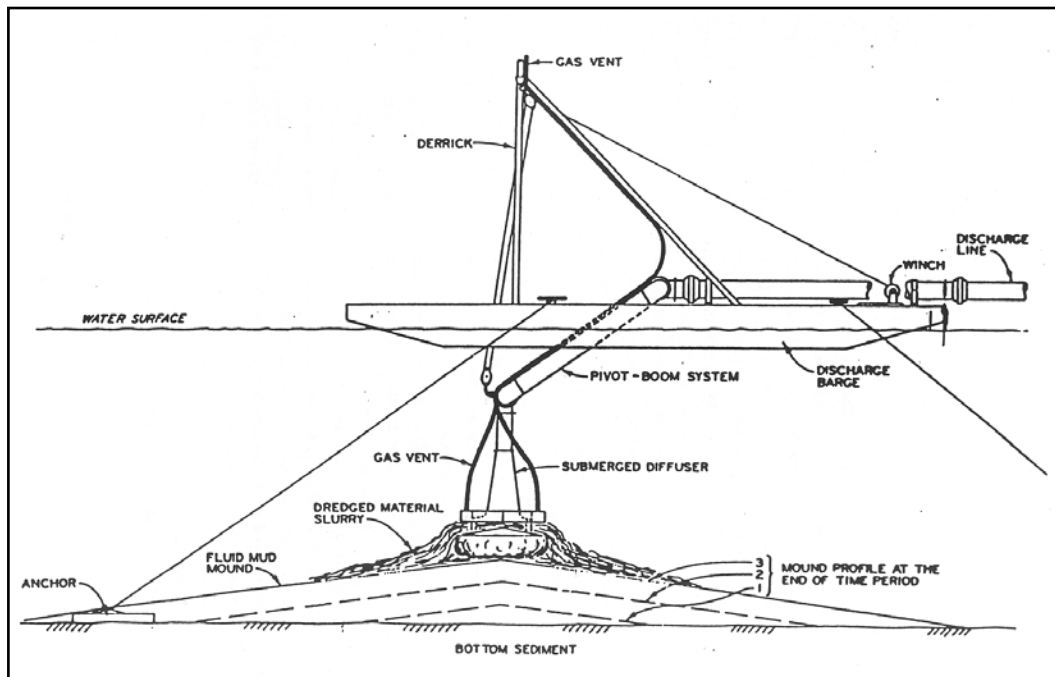

Figure 3-16. Discharge Barge Used to Provide both Support and the Capability for Lowering the Diffuser

e. The diffuser has a great deal of potential for eliminating turbidity in the water column and maximizing the mounding tendency of the discharged dredged material. The slurry remains in the pipeline/diffuser until it is discharged at low velocity near the bottom, or below a zone of high current velocity, thus eliminating all interaction of the slurry with the water column above the diffuser. This effectively eliminates water column turbidity. Unfortunately, using the diffuser does not eliminate the impact of the fluid mud on the benthic organisms, nor does it eliminate the possible resuspension of low-density material at the surface of the fluid mud mound by waves and ambient currents.

f. A variation of the DMRP diffuser design was used in an equipment demonstration at Calumet Harbor, IL. Although not constructed to the DMRP specifications, this diffuser significantly reduced pipeline exit velocity, confined the discharged material to the lower portion

31 Jul 2015

of the water column, and reduced suspended solids in the upper portion of the water column (Hayes, McLellan, and Truitt 1988). Diffusers have been constructed using the DMRP design and used at a habitat creation project in the Chesapeake Bay (Earhart, Clarke, and Shipley 1988), and at a Superfund pilot dredging project at New Bedford Harbor, MA, involving subaqueous capping (U.S. Army Engineer Division, New England, 1990). At the Chesapeake Bay site, the diffuser was used to effectively achieve dredged material mounding prior to placement of a layer of oyster shell to provide substrate for attachment of oyster spat. At the New Bedford site, the diffuser was used to place contaminated sediment in an excavated subaqueous cell and was effective in reducing sediment resuspension and in controlling placement of contaminated sediment. Diffusers have also been successfully used to place and cap contaminated sediments at projects in Rotterdam Harbor in The Netherlands (d'Angremond, de Jong, and de Waard 1984), and Antwerp Harbor in Belgium (Van Wijck and Smits 1991).

#### 3.7.3.4 Gravity-fed downpipe (tremie).

a. Tremie equipment can be used for submerged discharge of either mechanically or hydraulically dredged material. The equipment consists of a large-diameter conduit extending vertically from the surface through the water column to some point near or above the bottom. The conduit provides the desired isolation of the discharge from the upper water column and improves placement accuracy. However, because the conduit is a large-diameter straight vertical section, there is little reduction in momentum or impact energy over conventional surface discharge. The weight and rigid nature of the conduit require a sound structural design and consideration of the forces due to currents and waves.

b. The Japanese have used tremie technology in the design of specialized conveyor barges for capping operations (Togashi 1983; Sanderson and McKnight 1986). This equipment consists of a tremie conduit attached to a barge equipped with a conveyor (Figure 3-17). The material is initially placed in the barge mechanically. The conveyor then mechanically feeds the material to the tremie conduit. A telescoping feature of the tremie allows placement at depths of up to approximately 12 m (40 ft). Anchor and winch systems are used to reposition the barge by swinging it side to side and forward.

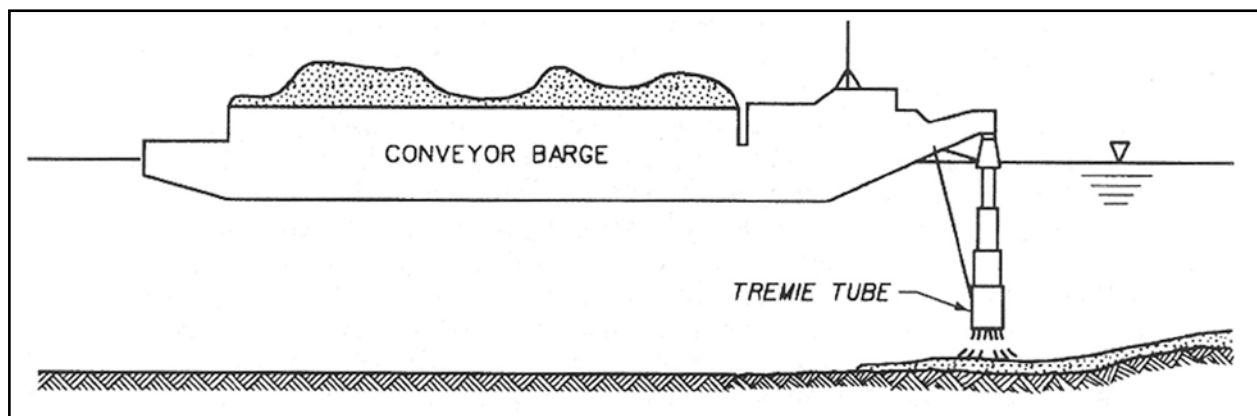

Figure 3-17. Gravity-Fed Downpipe (Tremie)

3.7.3.5 Hopper dredge pump-down. Some hopper dredges have pump-out capability by which material from the hoppers is discharged like a conventional hydraulic pipeline dredge. In addition, some have further modifications that allow pumps to be reversed so that material is pumped down through the dredge extended drag arms. Because of the expansion at the drag head, the result is similar to using a diffuser section. Pump-out depth is limited, however, to the maximum dredging depth, typically about 18-21 m (60-70 ft).

#### 3.7.3.6 Geosynthetic fabric containers.

a. Geosynthetic fabric containers (GFCs) are containers made from geosynthetic fabric that line barges. Contaminated dredged material is placed in the GFCs (either mechanically or hydraulically), which are then sewn closed prior to placing the GFC at the disposal site. The GFC acts as a filter cloth, allowing the water to escape but retaining almost all the fine (silt and clay) particles. Containing contaminated sediments in GFCs for subsequent placement from split-hull barges offers the potential to eliminate the wide, thin apron normally associated with conventional bottom dumping of fine-grained sediments, thus substantially reducing the volume of cap material required and reducing the potential for contaminated sediments to extend beyond the site boundary. GFCs also have the potential to eliminate water quality problems at the disposal site by essentially eliminating loss of fine sediment particulates and associated contaminants to the water column. As of 1996, GFCs have been used on only two USACE projects. The first was construction of training dikes in the lower Mississippi River (Duarte, Joseph, and Satterlee 1995), and the second was placement of sandy sediment with heavy metal contaminants in a CAD site in Los Angeles Harbor (Mesa 1995). At present, costs of using GFCs are much higher than for conventional bottom placement due to costs of materials, increased dredge cycle times, increased labor requirements associated with installation of the GFCs in the barge, and possible reductions in dredge production rate. There are also considerable engineering problems associated with successfully deploying the GFCs without having them rupture.

b. The decision to use GFCs for a capping project should be made based on the benefits versus costs rather than solely on the desire to reduce losses to the water column. Data collected from a 1996 demonstration of GFCs conducted jointly by New York District and the Port of New York and New Jersey should provide additional data on GFC viability. However, additional research is needed to better define GFC abilities to reduce water column losses of contaminants and to refine engineering aspects associated with deployment. Clausner et al. (1996) summarizes the present state of the art on using GFCs with contaminated sediments.

3.7.3.7 Treatment. Treatment of discharges into open water may be considered to reduce certain water column or benthic impacts. For example, the Japanese have used an effective in-line dredged material treatment scheme for highly contaminated harbor sediments (Barnard and Hand 1978). However, this strategy has not been widely applied, and its effectiveness has not been demonstrated for solution of the problem of contaminant release during open-water disposal.

3.7.4 Benthic controls. Management options aimed at reducing the physical impact and/or release of contaminants from benthic organisms include thin layer placement, level bottom capping (LBC) of contaminated material with suitable material, and subaqueous lateral confinement of material (CAD).

3.7.4.1 Thin-layer placement. Placement of dredged material in a thin layer (30 cm [12 in] or less) over wide areas is a management action that may be considered to offset physical effects because of burial (Nester and Rees 1988). Thin-layer placement allows benthic organisms to burrow up from newly placed material more easily and also increases the rate of recolonization of the disposal site.

3.7.4.2 Capping and contained aquatic disposal (CAD). Capping is the controlled accurate placement of contaminated material at an open-water placement site followed by a covering or cap of clean isolating material. For most navigation dredging projects, capping alternatives involving armor stone layers or other non-sediment materials would not normally be considered. Capping of contaminated dredged material in open-water sites began in the late 1970s, and a number of capping operations under a variety of placement conditions have been accomplished. The USACE has conducted over 20 capping projects, with the majority conducted by the New England Division. An overview of the field experiences related to capping of contaminated dredged material is presented in Palermo et al. (1998). Projects have included sites in Central Long Island Sound, the New York Bight area at the mouth of the Hudson River, Puget Sound, and Rotterdam Harbor in The Netherlands. The projects listed by Palermo et al. (1998) are not intended to be all-inclusive; rather, they are representative of a range of site and operational conditions. Conventional placement equipment and techniques are frequently used for a capping project, but these practices must be controlled more precisely than are conventional placement. Palermo et al. (1998) (<http://el.erdc.usace.army.mil/dots/doer/pdf/trdoer1.pdf>) present detailed capping guidance on design requirements, a design sequence, site selection, equipment and placement techniques, geotechnical considerations, mixing and dispersion during placement, required capping sediment thickness, material spread and mounding during placement, cap stability, and monitoring.

3.7.4.3 Level bottom capping (LBC). LBC is defined as the placement of a contaminated material in a mounded configuration and the subsequent covering of the mound with clean sediment (Figure 3-18). The objective of LBC is to place a discrete mound of contaminated material on an existing flat or very gently sloping natural bottom. A cap is then applied over the mound by one of several techniques, but usually in a series of placement sequences to ensure adequate coverage.

#### 3.7.4.4 Contained aquatic disposal (CAD).

a. CAD is similar to LBC but with the additional provision of some form of lateral confinement (for example, placement in natural bottom depressions constructed subaqueous pits, or behind subaqueous berms) to minimize spread of the materials on the bottom (Figure 3-18). CAD is generally used where the mechanical properties of the contaminated material and/or bottom conditions (for example, slopes) require positive lateral control measures during placement. Use of CAD can also reduce the required quantity of cap material and, thus, the costs. Options include the use of an existing natural or excavated depression; pre-excavation of a placement pit; or construction of one or more submerged dikes for confinement (Truitt 1987).

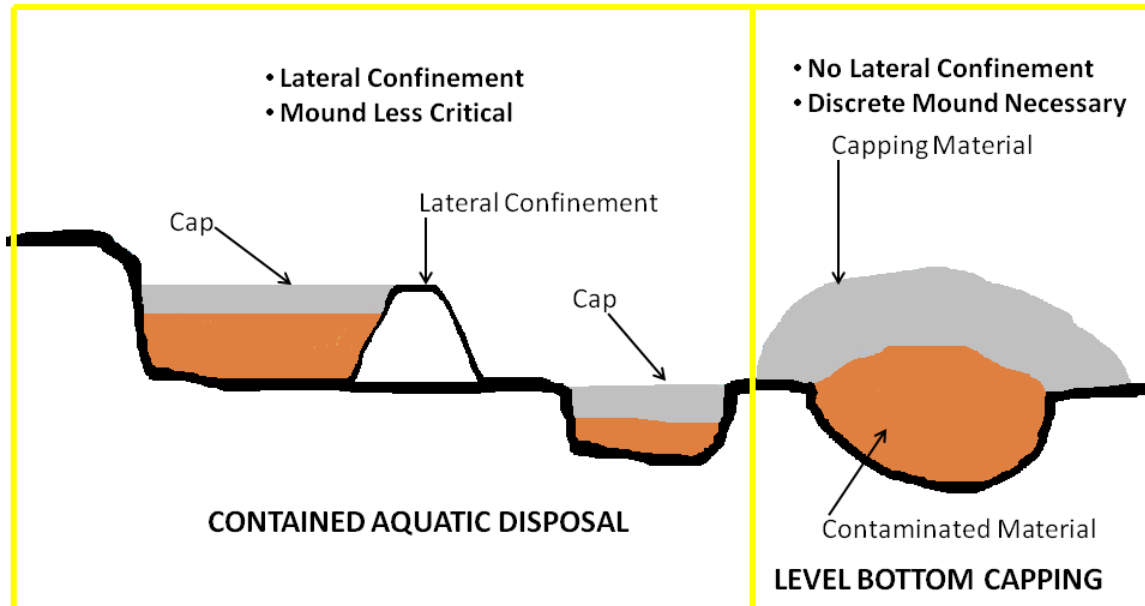

Figure 3-18. Contained Aquatic Disposal (CAD) and Level Bottom Capping (LBC)

b. Subaqueous borrow pits provide an ideal configuration for CAD. Such pits could have been previously excavated and left following sand or gravel mining operations or other purposes, or they could be excavated as constructed CAD pits solely for the purpose of providing site capacity for dredged material disposal. CAD in large borrow pits has been implemented in Hong Kong. Borrow pit CAD has also been implemented in Los Angeles, Portland, and Rotterdam Harbor (Palermo 1997). CAD pits (or cells) were specifically constructed for dredged material deposition in the Boston Harbor Navigation Improvement Project (Fredette et al. 2000) and Newark Bay (Matthews et al. 1999). Appendix D, "Plant Material for Beneficial Use Sites," describes several CAD projects and CAD siting, design, and operational considerations.

### 3.8 Open-Water Site Management and Monitoring.

3.8.1 Introduction. The goal of site management (Mathis and Payne 1984) is to prevent unreasonable degradation of the environment from dredged material. This goal must be considered in the context of the broader national goal to provide maximum protection to the overall environment and pursued as part of a comprehensive placement management strategy for dredged material. In general, the technical considerations for ocean site management and monitoring presented in this chapter are applicable for inland open-water sites under Section 404.

#### 3.8.2 Ocean open-water site management.

3.8.2.1 Section 103(b) of the MPRSA requires that the USACE use dredged material placement sites designated by the USEPA to the maximum extent feasible. Where use of a site designated by the USEPA is not feasible (for example, if the USEPA-designated site does not have a management plan after January 1, 1997, and is unavailable for use), the USACE may, with the concurrence of the USEPA, select an alternative site (MPRSA § 103[b]). The Water Resources Development Act of 1992 (WRDA 92, Public Law 102-580) made a number of

31 Jul 2015

changes to the MPRSA. As amended by Section 506 of WRDA 92, Section 102(c) of the MPRSA provides, in the case of dredged material ocean placement sites, the following:

a. As of January 1, 1995, no site may receive a final designation unless a management plan has been developed.

b. For sites that received a final designation prior to January 1, 1995, management plans were to be developed as expeditiously as practicable, but no later than January 1, 1997, with priority given to sites with the greatest potential impact on the environment.

c. As of January 1, 1997, no permit or authorization for dumping may be issued for a site unless it has received a final designation or it is an alternate site selected by the USACE under MPRSA Section 103(b).

3.8.2.2 MPRSA Section 102(c)(3), as amended by WRDA 92, sets forth a number of requirements regarding the content and development of site management plans. In the case of dredged material placement sites, the (USEPA) Administrator, in conjunction with the USACE Secretary, will develop a site management plan for each site designated pursuant to this section. In developing such plans, the Administrator and the Secretary will provide opportunity for public comment. Such plans will include, but not be limited to, the following:

a. A baseline assessment of conditions at the site.

b. A program for monitoring the site.

c. Special management conditions or practices to be implemented at each site that are necessary for protection of the environment.

d. Consideration of the quantity of the material to be disposed of at the site, and the presence, nature, and bioavailability of the contaminants in the material.

e. Consideration of the anticipated use of the site over the long term, including the anticipated closure date for the site, if applicable, and any need for management of the site after the closure of the site.

f. A schedule for review and revision of the plan (it must be reviewed and revised less within 10 years after adoption of the plan and every 10 years thereafter).

3.8.2.3 Guidance on fulfilling these requirements is provided in USEPA/USACE (1996). This document provides guidance to the USEPA Regions and the USACE Districts for preparation of ocean dredged material placement site management plans and lays out a recommended framework for site management plan development and content. This section of the EM summarizes various site management aspects from this guidance. For details concerning site management plan timing, review, availability, and funding, refer to USEPA/USACE (1996) (available at <http://water.epa.gov/type/oceb/oceandumping/dredgedmaterial/index.cfm>).



3.8.2.4 Management of an ocean dredged material disposal site (ODMDS) involves regulating the times, quantity, and physical/chemical characteristics of the dredged material that is dumped at the site; establishing placement controls, conditions, and requirements to avoid and minimize potential impacts to the marine environment; and monitoring the site environs to verify that unanticipated or significant adverse effects are not occurring from either the past or continued use of the placement site and that permit terms are met.

3.8.2.5 Appropriate management of ODMDS is aimed at assuring that placement activities will not unreasonably degrade or endanger human health, welfare, the marine environment, or economic potentialities (see the MPRSA §103(a)). ODMDS management is a continuum that begins with site designation. At this stage, the emphasis is on selecting a site where placement will not have a significant adverse impact on various amenities such as fisheries, coral reefs, historic sites (such as shipwrecks), or endangered species, or on other uses of the marine environment. The site designation criteria are set forth at 40 CFR 228.5 and 228.6. The ODMDS designation documents should identify any topics of special concern and, as appropriate, constraints and conditions on the use of the site for inclusion in the site management plan or permits authorizing site usage. The USEPA Region and USACE District also must establish appropriate monitoring plans, as required by the MPRSA §102(c)(3)(B).

3.8.2.6 Ocean dredged material placement sites are selected to minimize the risk of potentially adverse effects to human health and the marine environment. A decision to authorize placement at a designated ocean dredged material placement site (approve a project or permit, with or without conditions), is based primarily on the following:

- a. The placement site characteristics, as defined during the site designation process.
- b. Compliance with the ocean dumping criteria, including the results of effects-based testing of the proposed dredged material.
- c. The ability to manage the placement operation and monitor the site for changes.

3.8.2.7 These three elements also are building blocks for developing site management plans. The effective management of an ocean dredged material placement site is necessary to ensure that the dredged material placement will not result in unreasonable degradation to the marine environment. Site management plans facilitate management action by the USEPA Region and the USACE District over the full use period of the placement site and in appropriate cases, following site closure. Management plans should focus on the broad, overall management issues associated with ocean placement of dredged material at a given site. They also should identify critical amenities and site conditions warranting further consideration or continuing evaluation, such as unusual currents that could affect dispersal.

31 Jul 2015

### 3.8.3 Components of site management plans.

#### 3.8.3.1 Introduction.

a. Whenever the site management plan is developed, it should be prepared jointly by the USEPA Region and the USACE District responsible for managing the ocean dredged material placement site. Close coordination between the personnel of the Region and the District is essential to the preparation of a workable and effective management plan. Plan development must also include an opportunity for public comment. Components of a typical site management plan as required by Sec 102(c)(3) of the MPRSA, as amended by WRDA 92, are discussed below.

b. Site-specific management plans should be prepared in conjunction with the site designation and may be summarized in or appended to the site designation Environmental Impact Statement (EIS). However, time, funding, and administrative constraints, as well as incomplete characterization of the proposed dredged material, may have precluded the development of a management plan when the site was designated. After January 1, 1997, a permit or authorization for use of a designated site cannot be issued unless a management plan is in place or a site has been selected by the USACE pursuant to §103 of the MPRSA.

3.8.3.2 Objectives of site management plan. The site management plan should provide a clear, concise statement of management objectives and an overview of its purpose and function. Where applicable, specific management activities designed to address concerns identified during the site designation process should be clearly stated. The more specific the objective, the easier it is to identify appropriate management activities.

#### 3.8.3.3 Site management roles and responsibilities.

a. The management plan developed jointly by the USEPA Region and the USACE District should clearly identify roles and responsibilities for all participants and provide for coordination of management activities. The focus and intensity of site management activities are likely to vary on a case-by-case basis and site management roles and responsibilities may change.

b. Under the MPRSA, the USEPA Regions have responsibility for designation of ODMDs, although under the MPRSA Section 103(b), the USACE may select a placement site if use of a USEPA-designated site is not feasible. While the USACE Districts evaluate placement projects, and their issuance of permits or authorizations is subject to USEPA concurrence, development of management plans is a joint responsibility of the Regions and Districts (MPRSA Section 10(c)(3)). Enforcement is also a shared responsibility and depends on the nature of the violation.

c. The USEPA and the USACE are responsible for determining baseline conditions during designation of an ODMD. If supplemental baseline information is needed related to a specific authorized activity, it should be obtained in conjunction with the authorization of that activity. This would generally be the responsibility of the permittee or the USACE for Federal Projects. Identifying and evaluating any impacts outside the designated site typically is the responsibility of the USEPA Region and USACE District; permitted site users may be required to provide information to support such determinations.

3.8.3.4 Baseline assessment. The MPRSA 102(c)(3)(A) requires that the management plan include a baseline assessment of conditions at the site. The establishment of baseline conditions at an ODMDS is a part of the site designation process for new sites and part of the historical record for previously used sites. The intent is to determine if the site is suitable for designation, obtain data for future use in evaluating material for placement, and serve as a basis of comparison against which to measure potentially significant adverse impacts to the marine environment at or in the vicinity of the site. An original baseline is usually established during site designation where the sea floor has not been disturbed. This assessment may or may not accurately reflect the conditions inside and outside the site several years after sediment has been disposed of at the site. Since conditions in the site change after placement (for example, depth), new baseline information may need to be gathered prior to new placement operations.

3.8.3.5 Placement site characterization. Either the baseline established during site designation or additional site characterization data collected since designation should be used to provide a description of the placement site, the marine environment near the site, and the critical amenities that may be potentially affected by placement of dredged material. The site characterization described in the management plan should include a summary of the physical, chemical, and biological characteristics of the sediments and water column (see 40 CFR 228.5 and 228.6).

3.8.3.6 Placement site history. The placement activities at the site should be documented. This information is important for evaluating monitoring data and making adjustments to the management plan that will maximize site use and avoid any unacceptable impacts. Placement history information for management plan implementation typically includes the following:

- a. Known historical uses of the proposed placement site.
- b. Transportation and placement methods used.
- c. Monitoring findings.
- d. Enforcement activities.

3.8.3.7 Special management conditions or practices.

a. MPRSA 102(c)(3)(C) requires that management plans include special management conditions or practices to be implemented at the site for the protection of the environment, so they should be carefully considered during designation of the ODMDS or development of the management plan. The need for special management conditions or practices may also become evident during the evaluation of the material proposed for ocean placement and the nature of a particular placement operation(s). In this case, special conditions should be included, as necessary, in the permit or authorization for placement at the site.

b. Special management conditions or practices are likely to be unique to each ODMDS, material, or placement operation (for example, consider grain size to limit current transport or to match the existing substrate). Therefore, they need to be considered on a case-by-case basis. For some ODMDSs, there may be no need for special constraints on the placement of any material that meets the environmental impact criteria of the MPRSA regulations. For others, however,

31 Jul 2015

placement may need to be limited to certain types of material at certain times at a specific location within the site, or the quantity disposed within a given time period may need to be limited. Special management conditions (see paragraph 3.7 for more details concerning control measures) may include the following:

- (1) Placement methods.
- (2) Capping provisions.
- (3) Quantity restrictions.
- (4) Weather restrictions.
- (5) Sediment grain size restrictions.
- (6) Seasonal restrictions.
- (7) Equipment requirements (such as equipment for dredging, transportation and placement, and navigation and positioning).
- (8) Discharge point and allowable tolerances in position.
- (9) Debris removal provisions.
- (10) Provisions to address spillage, and leakage of dredged material.
- (11) Record-keeping and reporting requirements.
- (12) Inspection and surveillance provisions.
- (13) Other appropriate conditions necessary for protection of the environment.

#### 3.8.3.8 Quantity of material and presence of contamination.

a. MPRSA 102(c)(3)(D) requires that management plans include consideration of the quantity of the material to be disposed at the site, and the presence, nature, and bioavailability of the contaminants in the material. The quantity of material allowable for placement at a particular ODMDS is a function of the capacity of the site and the type of material. Nondispersive sites will eventually become “full.” The concern, in such a case, usually is that the material not impact amenities outside the ODMDS boundaries or cause a navigation hazard. There may also be vertical limitations to avoid navigation hazards.

b. For dispersive sites, the material may not remain within the boundaries of the ODMDS after placement. The rate and direction of movement across the ODMDS boundaries is determined by physical transport mechanisms. Depending on these transport mechanisms and the nature of the material, transport may be rapid and continuous, or it may occur only during episodic events, such as storms or seasonal changes in transport mechanisms. The management of dispersive sites is usually focused on the vertical axis with the goal being to avoid formation

of navigational hazards from shoaling. The management plan should summarize the information used in determining the overall size of the site and its life span and to protect against storm-induced erosion.

c. The presence, nature, and bioavailability of contaminants in the dredged material are determined during the evaluation of the material proposed for dredging and placement. National guidance (the Ocean Testing Manual [OTM]) on dredged material evaluation has been jointly developed by USEPA and USACE (USEPA/USACE 1991) (for Section 404 placement the Inland Testing Manual [ITM] [USEPA/USACE 1998] applies). For more information on the OTM and ITM, see paragraph 3.6.

d. The guidance developed is national in scope and cannot address every local or site-specific concern. Therefore, regional implementation manuals have been developed to adapt, as necessary, the generic elements of the guidance to the specific conditions found at regional placement sites. Local District/Region manuals typically provide the following information for specific placement sites:

- (1) Contaminants of concern.
- (2) Test organisms for bioassays.
- (3) Reference sediment location(s).
- (4) Ambient water quality for elutriate evaluations.
- (5) Mixing zone parameters for model analyses.
- (6) Factors to evaluate bioaccumulation data.

e. The evaluation procedures are intended to ensure that all dredged material placement is consistent with the MPRSA. The information is used by the USACE District and USEPA Region to evaluate the suitability of the dredged material for placement at a given site. Any conditions resulting from those evaluations would be included in the documents authorizing placement at the site. Monitoring is used to assess whether the predictions regarding impacts to the environment from specific dredged material at the particular placement site were correct. The site management plan should summarize the appropriate requirements used to determine the suitability of the dredged material.

3.8.3.9 Anticipated site use. MPRSA 102(c)(3)(E) requires that the management plan include consideration of the anticipated use of the site. The management plan must describe the anticipated use of the site over the long term, including the anticipated closure date for the site, if applicable, and any need for management of the site after the closure of the site. As indicated above, the anticipated use should be considered in developing site conditions and monitoring plan.

3.8.3.10 Site management plan review and revision. MPRSA 102(c)(3)(F) requires that the management plan include a schedule for review and revision of the plan—it must be reviewed and revised within 10 years after adoption of the plan and then every 10 years thereafter. The management plan should describe how modifications or updates may be made based on specific needs identified for specific authorized projects. If the site is not used for over 10 years, the management plan should be updated in conjunction with activities authorizing use of the site.

3.8.3.11 Monitoring program.

a. MPRSA 102(c)(3)(B) requires that management plans include a program for monitoring the site. Site monitoring is conducted to ensure the environmental integrity of a placement site and the areas surrounding a site and to verify compliance with the site designation criteria, any special management conditions, and permit or Federal authorization requirements. Monitoring programs should be flexible, cost-effective, and based on scientifically sound procedures and methods to meet site-specific monitoring needs. A monitoring program should have the ability to detect environmental change and assist in determining regulatory and permit compliance. The program should be designed to provide the following:

(1) Information indicating whether the placement activities are occurring in compliance with the permit and site restrictions.

(2) Information indicating the short-term and long-term fate of materials disposed in the marine environment.

(3) Information concerning the short-term and long-term environmental impacts of the placement.

b. It is important to understand that placement site monitoring is not a stand-alone activity; it is based on the site designation process, the characteristics of the dredged material, and compliance with permit or MPRSA §103(e) authorization terms. Placement site monitoring is a key component of site management. The main purpose of a placement site monitoring program is to determine whether dredged material site management practices, including placement operations, at the site need to be changed to avoid unreasonable degradation or endangerment of human health or welfare or the marine environment.

c. Continuous monitoring of all physical, chemical, and biological parameters and resources in and around a typical placement site is not necessary. Monitoring programs should be structured to address specific questions (null hypotheses) and measure the conditions of key indicators and end points, particularly those identified during site designation, or any major project-specific issues that arise.

d. Because of their site-specific nature, no two placement site monitoring programs are likely to be exactly the same. Monitoring activities should be tiered (see Zeller and Wastler [1986] for a discussion of tiered monitoring). The number of monitoring tiers, categories of hypotheses, and other program elements can and do vary among regions and placement sites. The ultimate

responsibility for the design of site-specific monitoring programs resides jointly with the USACE Districts and USEPA Regions.

e. The USACE Districts and USEPA Regions should design an effective monitoring program as a tiered series of investigations. The most effective monitoring programs for ocean placement sites should do the following:

- (1) Integrate as components of site management.
- (2) Evaluate the fate and effect of dredged material placement.
- (3) Use a tiered monitoring approach.

f. Link specific measured effects (action levels) with predetermined management actions.

g. Support decision-making.

In addition to serving as a basis for management actions, the site monitoring program provides an historical record of site conditions that can be used in the future to understand the impacts of past site management. The data form the basis of technical discussions regarding the site that lead to better and more informed management decisions. Site monitoring results also provide a data record that can be used to determine the need for current and future management actions or permit conditions.

h. Site management plans must describe the overall monitoring program designed to monitor the environment of the placement site. The monitoring program should be based on an overall assessment of what is known about the site environs, the past use of the site, and amenities in or near the site that need to be protected. The development of the monitoring program should include an assessment of the following:

- (1) Baseline or environmental information collected at or near the site describing its condition in the past and/or present.
- (2) Characteristics of materials already dumped at the site and characteristics of materials that may potentially be dumped at the site in the future.
- (3) Special management conditions used at the site that could affect the environmental effects or fate of dumped material.

Management plans should use this type of information to develop realistic questions (null hypotheses) regarding potential impacts that need to be answered to protect the environment of the site. These questions should address all realistic environmental concerns and should be specific. They should cover such issues as long- and short-term fate of the dumped material and its long- and short-term effects. The management plan should then describe if/how the existing knowledge about the site answers any of the questions. The remaining questions should be specifically identified in the management plan monitoring program, and the types of monitoring proposed to collect sufficient information to answer them should be described. This should be

done at a sufficient level of detail to provide an overall structure and focus for subsequent monitoring activities. However, details such as precise sampling stations and frequencies are better left to subsequent development of survey plans rather than being included in the MPRSA site management plan as the specifics will vary over time and frequency of placement as well as being affected by budgetary considerations.

3.8.4 Monitoring program. Fredette et al. (1990a) recommend an approach to a monitoring program design that emphasizes useful results for dredged material placement site managers. Fredette et al. (1990a) focuses on dredged material determined suitable for open-water placement; therefore, the report does not consider lethal or sublethal effects of toxic substances. However, in cases where contaminants are of concern, the monitoring strategy outlined herein can be used, but with the appropriate sampling techniques for such materials incorporated in the study design. Pequegnat, Gallaway, and Wright (1990) address contaminated dredged material monitoring.

#### 3.8.4.1 Monitoring program design.

a. The design of a prospective program requires two general steps: the evaluation of managerial needs and objectives for site use and the design and implementation of a prospective monitoring program. Evaluation for each component of a monitoring program should be multitiered, with each level having its own environmental threshold, hypothesis, sampling design, and management option(s) should the environmental threshold be exceeded.

b. In a tiered approach, each objective is monitored by testing a series of hypotheses, each at a different predetermined level (tier) of intensity. Results that indicate acceptance of the null hypothesis (the threshold is not exceeded) at any level prevent further, more costly monitoring at the next more complex level. Results indicating rejection of the null hypothesis trigger monitoring at higher levels, thereby providing an “early warning” system for detection of predetermined adverse effects. This early warning system allows site managers to make modifications in operations before an unacceptable impact occurs.

3.8.4.2 Stepwise procedure for outlining a program. The systematic approach toward designing a monitoring plan is presented in Figure 3-19 to illustrate plan development. Consideration of each of the five steps helps to ensure that all pertinent aspects of a plan are incorporated.

a. Designation of site-specific objectives and needs. Site-specific objectives and needs might include such factors as multiple/periodic versus one-time use of the site, seasonal timing and frequency of use, and use of the site for habitat creation or enhancement. In the case of seasonal timing and frequency of usage, questions about impacts reflect concerns over detrimental alterations of biological resources. Conversely, considerations of habitat creation or enhancement include levels of measurable improvement of the site for beneficial resource utilization.

b. Identify plan components. A useful early step toward the design of a monitoring program should include the identification of physical, chemical, and biological parameters of concern. This task reflects predictions of the types of direct and indirect alterations that result from placement activities. Physical and chemical effects are generally readily measured and include



those associated with sediment characteristics as well as spatial distribution of the material after placement. These alterations represent both short- and long-term direct effects to the biota (for example, those resulting from changes in grain size and bottom topography). Alterations in water quality are generally short-lived, and while concerns over them may be justified during placement, they are generally not considered as part of a long-term monitoring program.

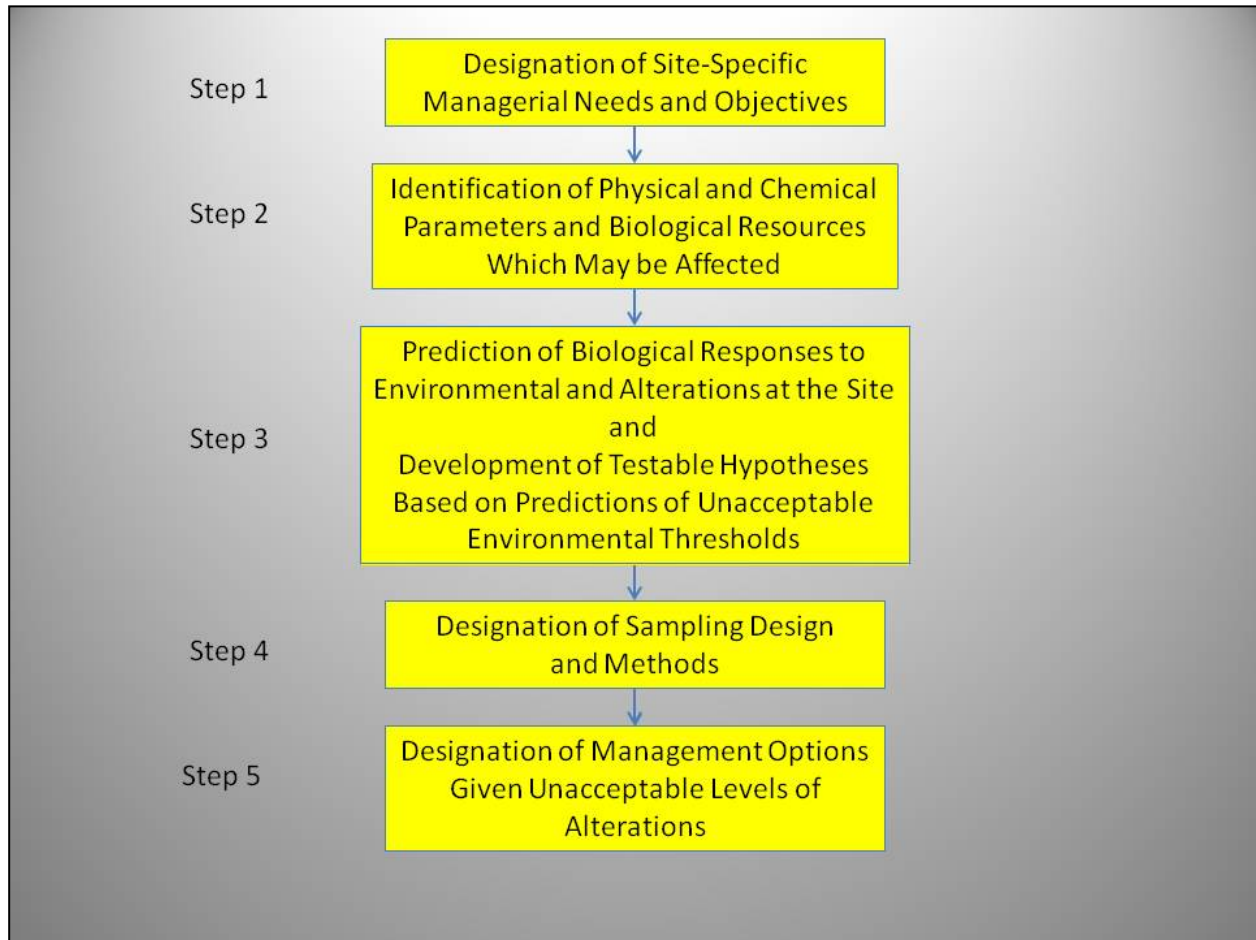

Figure 3-19. The Systematic Approach Toward Designing a Monitoring Plan

c. Predict responses and develop hypotheses. This aspect of program development requires quantitative estimates of alteration of each physical/chemical parameter of concern and best available information on the levels of response of target resources to these alterations. By comparing these estimates, critical threshold levels can be used in management decisions on project continuation or cessation. Specific information is needed on the range of a parameter within which a particular organism is capable of normal behavior. The upper limit of the range may be used as a threshold level at which a decision to alter operations must be made.

d. Select sampling design and methods.

(1) The design of a sampling program and choice of appropriate methods is as important as any of the steps so far discussed. The ways in which data are gathered (sampling methods) and analyzed (statistical methods) determine their usefulness in drawing conclusions about the

given study. Most importantly, the sampling design must be developed with a priori considerations of the type(s) of data that will be collected and the specific statistical analyses that will be applied. Again, it must be emphasized that the data that are collected must be applicable to addressing a specific question. Collecting data for no specific reason serves no purpose. The choice of sampling method or gear is also an important consideration in that the type of data obtained must be useful in addressing the specific question. A number of references (for example, Cochran 1963 and Green 1979) discuss the problems associated with sampling design and methodology.

(2) Spatial and temporal sampling intensity is generally low for tier 1 monitoring. As the tier level increases, frequency of sampling also increases. This applies to biological monitoring as well. Most sampling plans establish a regular or modified grid over the placement study site for sample collection to ensure complete site coverage. Grid spacing, size, and shape depend on tier level, site conditions, and available resources. Tier I grids are typically widely spaced, with a few sampling points covering the minimal area of anticipated impact. With increasing tiers, grid spacing is reduced, sampling frequency is increased spatially and temporally, and the grid area may be increased. Temporal sampling frequency is highly dependent on the anticipated level of impact and on temporal variability of the physical and biological site characteristics.

e. Designate management options. This step in the planning process involves decisions to be made in the event that threshold levels are exceeded. In a tiered program, these decisions are made at various tiers within the monitoring process but are, in each case, the result of exceeding a predetermined threshold. In the scheme of the hypothesis testing protocol, this process is the response to rejecting the null hypothesis (for example, there is a significant difference between observed and predicted conditions). In addition, management decisions are also needed on available options once conditions of a given parameter return below a critical threshold level. The options may include delaying or stopping operations, or modifying operations to alleviate the problem.

### 3.8.5 Monitoring tools.

#### 3.8.5.1 Introduction.

a. Information on the physical processes and biological environment at the open-water placement site before, during, and after dredged material placement is necessary to understand placement site conditions and the short- and long-term effects of placement at the designated site for dredging project planning and open-water site management. Monitoring tools are needed to achieve the objectives of monitoring programs. Tools for physical data collection at open-water placement sites include sensors, equipment systems, direct sampling devices (sediment grab sampler), and accurate positioning systems. Biological data collection also requires direct sampling devices such as nets and traps. Additionally, in-house data analysis tools are necessary. Selecting tools to use for each monitoring program is dictated by the site-specific questions to be answered.

b. Site monitoring may occur during baseline assessments for site designation or selection, during placement operations, or following placement operations. The following site characteristics should be considered for open-water site monitoring programs:

(1) Currents.

(2) Wave climate.

(3) Water level.

(4) Water depth.

(5) Bathymetry.

(6) Water quality parameters (for example, total suspended solids [TSS], turbidity, conductivity, temperature, pressure, density, salinity, dissolved oxygen, and fluorescence).

(7) Physical characteristics of bottom sediment, including sediment grain-size differences.

(8) Chemical and biological site characteristics (for example, relative abundance of various habitat types in the vicinity, relative adaptability of the benthos to sediment deposition, presence of submerged aquatic vegetation, and presence of unique, rare or endangered, or isolated populations).

(9) Sediment plume movement.

c. Fredette et al. (1990b) describe selected tools and techniques used for biological and physical monitoring of aquatic dredged material placement sites. A wide variety of tools is discussed, ranging from those that are routinely used in monitoring to those that are occasionally used for special cases or research purposes. Fredette et al. briefly describe each tool and its intended use, and then evaluate its usefulness for routine or extraordinary monitoring. Past examples of use, approximate instrument costs, ease of data interpretation, and instrument attributes and limitations are discussed. Examples of tool selection for different monitoring levels are presented in Fredette et al. (1990a; 1990b). Specific tools for monitoring open-water placement site characteristics are described below, together with a description of monitoring equipment and techniques for identifying and tracking dredged material sediment plumes summarized from Puckette (1998).

3.8.5.2 Currents. Instruments capable of measuring current speed and direction include mechanical, electromagnetic, and acoustic Doppler sensors. Historically, mechanical and electromagnetic sensors have been used for current measurements. However, these sensors are limited to measuring water velocity in waters surrounding the sensor at a fixed point in the water column and are more susceptible to fouling. Acoustic Doppler current sensors are now widely used to measure current velocity profiles under a variety of conditions. They can continuously measure velocities at discrete intervals over the entire depth of the water column. The sensor can be mounted either on a fixed platform providing long-term current data at one location or on a roving vessel to provide regional current data.

3.8.5.3 Waves and water levels. Pressure sensors are standard equipment for measuring wave parameters, such as wave height, period, and direction; water levels; and tides in shallow coastal waters. Pressure sensors are connected to data concentrators for data storage and can be directional or nondirectional. Single pressure sensors cannot provide wave direction. An array of three pressure sensors is typically used to collect directional wave spectra and water level data from which wave direction can be calculated. Wave gage systems can be deployed in a bottom-mounted tripod for either self-contained or real-time data collection. For real-time data collection, the equipment is cabled to a shore station, a data manager calls up the gage through the shore station, and the data are transmitted and downloaded to the base station. Wave and water level sensors can also be mounted to piers or other permanent structures. Chapter 7, "Positioning Techniques for Offshore Engineering Surveys," in EM 1110-2-1003, "Engineering and Design – Hydrographic Surveying," describes techniques for measuring tide and water levels, and Morang, Larson, and Gorman (1997a) discuss planning considerations for measuring waves and water levels, including gage types, and data collection and analysis.

#### 3.8.5.4 Water depth and bathymetry.

a. Dredging applications requiring bathymetric measurements include pre- and post-dredging surveys and general project condition surveys. Single-beam fathometers (acoustic depth or echo sounders) are standard equipment for measuring open-water site bathymetry. Multibeam sonars are also widely used within the USACE to collect water depth and bathymetry data. The multibeam sonar is a compact, portable, single-transducer swath technology that utilizes 60 to 240 beams to provide high-resolution bathymetric images. Fathometers are still an industry standard because they are less expensive than multibeam sonars. However, multibeam sonar systems have the advantages of more rapid data collection and a higher resolution data set. Additional information about bathymetric surveys and related equipment are provided in Engineer Manual 1110-2-1003. Morang, Larson, and Gorman (1997b) also discuss surveying equipment, including multibeam sonar, for monitoring water depth and bathymetry in coastal areas.

b. The Joint Airborne Lidar Bathymetry Technical Center of Expertise (JALBTCX) is responsible for operations, research, and development in airborne lidar bathymetry and complementary technologies to support the coastal mapping and charting requirements of the USACE, the US Naval Meteorology and Oceanography Command, and the National Oceanic and Atmospheric Administration (NOAA). JALBTCX executes survey operations using the Compact Hydrographic Airborne Rapid Total Survey (CHARTS) system and industry-based coastal mapping and charting systems. CHARTS collects either 20 kHz topographic lidar data or 3 kHz bathymetric lidar data, each concurrent with digital RGB and hyperspectral imagery. Survey operations support the USACE National Coastal Mapping Program and U.S. Naval Oceanographic Office (NAVOCEANO) nautical charting missions. JALBTCX replaces the USACE's Scanning Hydrographic Operational Airborne Lidar Survey (SHOALS) system. For further information, see the JALBTCX website (<http://shoals.sam.usace.army.mil/>).

### 3.8.5.5 Physical characteristics of bottom sediment.

a. Acoustic equipment systems are widely used to characterize bottom sediments at open-water sites. The side-scan sonar uses high-frequency acoustic signals to image sediment distribution on the seafloor and bottom features such as ripples and outcrops. Additionally, side-scan sonars are valuable tools for evaluating the underwater condition of breakwaters, bridge piers, and other underwater structures (Kucharski and Clausner 1990). Morang, Larson, and Gorman (1997b) describe practical and planning considerations for conducting side-scan surveys and provide examples of side-scan sonographs (data products) and interpretations.

b. Subbottom seismic profiling systems are typically used in open-water site condition surveys and disposal mound investigations to examine seafloor features and as part of an acoustic impedance method to characterize sediment density and type rapidly and accurately. These impulse-type devices transmit acoustic energy over a wide range of frequencies. High-resolution subbottom profiling systems specifically designed for shallow water use and operating at frequencies below 12 kHz are typically used for data collection. “Pinger” systems have higher operating frequencies (3.5-7.5 kHz) and provide higher vertical resolution while “boomer” systems have lower operating frequencies (300-400 Hz) and provide the greatest penetration into the subbottom (EM 1110-2-1003). The acoustic impedance method is briefly described in Chapter 2, “Dredging and Navigation Project Management,” and discussed in detail in EM 1110-2-1003 and McGee, Ballard, and Caulfield (1995).

c. The sediment profile camera takes photographic images of bottom sediments and provides a vertical view of the sediment/water interface. The camera is mounted in a frame and lowered to the seafloor. On the bottom, a viewing prism penetrates the upper sediment layer (up to 18 cm) and records an image on film (Fredette et al. 1990b; Rhoads, Muramoto, and Ward 1996). In addition to measuring depth of surface sediment layers, the image can be analyzed for a wide range of physical, chemical, and biological characteristics. Fredette et al. (1990b) list the various types of data that can be obtained from sediment profile imaging, including grain size, sediment surface relief, redox area and contrast, epifauna, and infauna. The sediment profile camera is used for various applications at open-water dredged material placement sites, including baseline surveys, predisposal site assessment, postdisposal compliance monitoring, mapping of dredged material footprints and caps placed on contaminated dredged material, long-term monitoring of dredged material, and documenting faunal colonization (Rhoads, Muramoto, and Ward 1996).

d. The sediment profile camera reduces the number of grab or dredge samples needed to characterize certain benthic habitats. However, it cannot provide quantitative characterization of the benthic community structure. The use of the sediment profile camera combined with traditional benthic sampling devices is recommended.

e. The Gamma Isotope Mapping System/Continuous Sediment Sampling System (GIMS/CS<sup>3</sup>) is a towed sled surveillance system that rapidly measures and maps surface sediment parameters for geotechnical and environmental characterization in aquatic environments. It was developed by the Center for Applied Isotope Studies (CAIS) at the University of Georgia, Athens, and has been applied to Federal government point (USEPA) and nonpoint (USGS) contaminant source investigations (Noakes, Noakes, and Dvoracek 2000). The system is composed of a towed sled

with multiple sensors capable of operating simultaneously for continuous data and sample collection. The GIMS measures natural radiation emanating from seafloor, lake-bottom, or river-bottom sediments to approximately 25 m (82 ft) below the seafloor surface with a submersible gamma radiation detector to interpret sediment lithology and identify natural or anthropogenic radioisotopes in bottom sediments. The CS<sup>3</sup> collects sediment samples with a submersible pump that delivers the samples as a sediment slurry to the survey vessel for shipboard analysis (Noakes, Noakes, and Dvoracek 2000; Rhoads, Muramoto, and Ward 1996). The sled sensor array is connected with a coaxial cable to surface shipboard electronics, which include a portable computer and printer, differential GPS navigational unit and plotter, spectrometer to transmit the data signal from the detector, and sediment sample processor. The sled can be deployed from a variety of vessels and operated in depths up to 100 m (328 ft). It is towed at speeds of 2.5-3 knots along specified survey transects and can cover up to a 128 km transect in 24 hours. Data from the sled systems can be used to generate two- and three-dimensional maps of bathymetry, gamma activity levels, and elemental concentrations in the area. Further information about the GIMS/CS<sup>3</sup> sled can be found at the CAIS website ([http://cais.uga.edu/programs\\_applications/aquatic\\_surveys/index.php](http://cais.uga.edu/programs_applications/aquatic_surveys/index.php)) and in Noakes, Noakes, and Dvoracek (2000).

f. Direct methods of obtaining sediment samples for sediment characterization through laboratory analyses include a variety of instruments, ranging from grab samplers, which one person can operate to retrieve a small surface sample, to large vibracores, which return up to a 12.2 m (40 ft) long core through a placement site (see paragraph 2.13.7).

3.8.5.6 Water quality parameters. Typical monitoring programs for open-water placement sites measure the following water quality parameters: TSS, turbidity, density, temperature, conductivity or salinity, dissolved oxygen and pH, and fluorescence. Typically, TSS is determined from offsite laboratory analyses of water samples collected at the placement site. More recent laser-beam instrumentation, the Laser In Situ Scattering and Transmissometry (LSST), which measures the scattering of a laser beam by particles in a volume of water with real-time data return capabilities, is emerging as an alternative method for measuring TSS in situ more accurately (Puckette 1998). Turbidity can be measured in situ using optical instruments that include transmissometers and nephelometers (also called optical backscatter [OBS] sensors). OBS is capable of measuring much higher particle concentrations than a transmissometer though it lacks the accuracy of the transmissometer at low-particle concentrations (D&A Instruments 1989). Particle concentrations can be estimated from both types of instruments using empirically determined calibration curves. An instrument referred to as a CTD measures water conductivity, temperature, and depth/pressure (CTD). Salinity is calculated from measurements of conductivity and temperature, and density is calculated from measurements of temperature, salinity, and pressure. Sensors for measuring dissolved oxygen and pH have evolved to be compact, reliable, and highly accurate. Fluorescence was measured, until recently, by taking a water sample and running it through a field instrument. However, fluorometers can now measure fluorescence in situ.

#### 3.8.5.7 Biological site characteristics.

a. Benthic infauna (particularly macrobenthos) and submergent vegetation are regarded as good indicators of environmental quality because of their sedentary nature and, thus, their

susceptibility to physical and chemical alterations. Because their sedentary existence requires a tolerance of short-term variation in environmental conditions, they reflect long-term integral conditions. In addition, they can be sampled more quantitatively and efficiently. Benthic sampling devices come in a wide variety of designs and sizes. Many were developed and used on a regional basis and, as a consequence, are little known outside their respective areas. However, certain commonly used samplers have had widespread application.

b. Nektonic organisms (fishes, shrimps, and crabs) are most commonly sampled with nets or traps of various types. Nets generally collect a greater diversity of organisms than do traps. Traps are usually designed to attract and capture a particular species (for example, crab pots). The choice of sampling device(s) for monitoring depends on the type(s) of organisms of interest. Nets are either passive or active collectors of organisms. Passive nets are set in stationary positions, collecting organisms that become entangled (for example, anchored gill nets, hoop nets, and fyke nets) or entrapped within the confines of the netted area (for example, fish traps) and may require extended deployment, in-place, and recovery periods. Active nets (for example, otter trawls and purse seines) are towed through the water and produce more immediate results.

c. Grab samplers and box corers are the tools of choice for quantitative sampling of sessile epifauna and infauna (to the depth excavated by the sampler). Some of the more commonly used grabs include the Petersen, van Veen, Ponar, Ekman, and Smith-McIntyre. Basically, these samplers all operate as mechanical scoops that, when triggered, remove a semicircular parcel of the bottom substrate. Typically, these samplers collect material representing 0.02-0.5 m<sup>2</sup> (0.2-5 ft<sup>2</sup>) of surface area and penetrate to sediment depths ranging from 5 to 20 cm (2-8 in.). (See Table 2 of Fredette et al. [1990a] for more information on grab samplers.) Vertical sectioning, which is generally more quantitative than basic grab sampling, is also possible with certain instruments, such as the Reineck and Gray-O'Hara box corers.

d. A number of trawls and dredges have been designed and used as qualitative samplers of epifaunal and infaunal organisms in a variety of habitats, particularly in water deeper than 10 m (33 ft) (for example, epibenthic sleds). These devices are best used for the purpose of general description of the assemblages present (species presence/absence). They are highly selective and are limited to collecting epifauna and shallow infauna, thereby providing little information on infauna at sediment depths greater than a few centimeters.

e. The sediment profile camera, discussed previously, reduces the number of grab or dredge samples needed to characterize certain benthic habitats. However, it cannot provide quantitative characterization of the benthic community structure. The use of the sediment profile camera combined with traditional benthic sampling devices is recommended.

f. Most fish and shellfish sampling devices are selective in terms of size and, often, species, causing a bias in the resulting estimates of density, species diversity, or biomass. Considerable difficulty is often faced in obtaining replicate data, due to the variability in dispersion of individuals and their mobility, which results in great variability of both time and space. The combination of variability in abundance of fish and shellfish species and the variation in sampling equipment and methods makes comparisons of data from various sources imprecise over large areas.

g. The Submersed Aquatic Vegetation Early Warning System (SAVEWS) is a bathymetric survey system designed to measure and characterize shallow-water aquatic environments (Sabol and Burczinski 1998). SAVEWS detects submerged aquatic vegetation coverage, canopy density, and height using commercial hydroacoustic equipment, and provides accurate bottom tracking in dense aquatic vegetation (eelgrass). The system hardware consists of a Biosonics DT4000 hydroacoustic echo sounder (Biosonics, Inc., Seattle, WA) with a 420 kHz, 6°, single-beam transducer, GPS, and personal computer components for data collection and analysis. The echo sounder is deployed from the survey vessel with the transducer in the water aimed downward in a vertical position. The survey vessel collects data with SAVEWS by traversing preselected linear transects. Vessel operating speed is approximately 2.5 m/s (8 ft/s) to avoid cavitation around the transducer (Sabol and Burczinski 1998). The echo sounder data are recorded with latitude and longitude reports from a real-time differentially corrected GPS. A signal-processing algorithm examines echo return data and GPS reports to output a position-referenced set of vegetation attributes to determine depth, percent plant coverage, and plant height. Since 1996, SAVEWS performance has been continuously tested in the Caloosahatchee Estuary in southwest Florida (Sabol et al. 2002). Alternate signal-processing techniques were investigated to improve SAVEWS bottom tracking accuracy. Sabol and Johnston (2001) found that the SAVEWS provided excellent bottom tracking performance under a wide range of seagrass densities, very good in situ plant height, and reasonably good vegetation coverage estimates relative to visual methods.

3.8.5.8 Navigation and positioning equipment. Accurate navigation and positioning equipment is an important tool for monitoring open-water sites. The effectiveness of all physical, chemical, and biological sampling depends upon knowing the location of a sample relative to the placement site. A variety of equipment types, with accuracies ranging from  $\pm 1,500$  to  $\pm 0.1$  ft, is available, but DGPS is used the most.

3.8.5.9 Physical monitoring tools and techniques for evaluating dredged material plumes.

a. A variety of parameters associated with dredged material plumes, including water quality and movement and dimensions of suspended sediment plumes, can be monitored. Selection of parameters to monitor depends on the purpose of the monitoring effort and site conditions.

b. The various sampling techniques fall into four general categories:

(1) In situ sampling of water quality parameters.

(2) Acoustic monitoring.

(3) Remote sensing.

(4) Dye studies.

c. Puckette (1998) discusses the physical monitoring equipment and techniques in greater detail. Typical monitoring programs for dredge-related sediment plumes measure one or more of the following in situ water quality parameters associated with the plume: TSS, turbidity, density, temperature, conductivity or salinity, pH, and fluorescence. In situ sampling of water quality



parameters may be conducted using equipment and techniques previously described in this section.

d. Acoustic sensors used for identifying and tracking suspended sediment plumes include fathometers and related instruments, acoustic Doppler current instruments, side-scan sonar, and scanning sonar. Acoustic Doppler sensors, used to measure water velocity and direction, also measure backscatter intensity through the water column. Backscatter intensity data can be used to calculate sediment concentration using empirically derived equations. Water samples must be collected concurrently with the acoustic data, analyzed for TSS, and then compared to the acoustic backscatter measurements. Based on this comparison, an equation is derived that relates the TSS to the acoustic backscatter. This method of determining dredged material plume sediment concentrations is reasonable in situations where sediment grain-size distributions and sediment concentrations remain relatively constant in both time and space, such that it is possible to collect concurrent acoustic and water-sample data. However, errors in TSS concentration determined from the backscatter data can be high.

e. Dredged material plume tracking technologies were investigated during the DRP (1989-1994), which resulted in development of the PLUMES Measurement System (PLUMES). The PLUMES consists of equipment systems, including a broadband acoustic Doppler current profiler (BBADCP), and plume tracking techniques. Kraus and Thevenot (1992); Tubman (1994a and 1994b), Kraus (1991); Thevenot, Prickett, and Kraus (1992); Lohrmann and Huhta (1994); and Tubman (1995) describe PLUMES development and testing. The system was tested in shallow-water placement sites in Mobile, AL (Kraus 1991), and Tylers Beach, VA (Thevenot, Prickett, and Kraus 1992). The PLUMES was also used to monitor dredged material disposed from a hopper dredge at a deepwater offshore disposal site near San Francisco, CA (Tubman, Brumley, and Puckette 1994). In all of the test cases, the PLUMES successfully identified and tracked the suspended sediment plumes.

f. The Sediview Method<sup>TM</sup> developed by Dredging Research Limited is also used to monitor suspended sediments. Like PLUMES, this method uses a BBADCP, but is different in that the Sediview Method data processing software can reduce the errors associated with estimating suspended sediment (Land and Bray 1998) by using an iterative approach to calculate the suspended particle concentration. In addition, this method requires an extensive calibration of the ADCP using water samples taken throughout the acoustic data collection as frequently as every 10 min.

g. Aerial photography is a remote sensing technique for monitoring suspended sediment plumes. Aerial photography can provide very good information on the spatial extent of plumes in the uppermost part of the water column under the right conditions. However, aerial photography is limited to daylight hours and by weather.

h. Dye studies have been used often to monitor plumes associated with sewerage and stormwater outfalls. However, this procedure, in which a fluorescing dye or particle tracer is injected into the water as sediment slurry, has also been used to track sediment dispersion from dredging. Dispersion tracking is accomplished by collecting water and sediment samples through the water column and at selected locations to determine redeposition locations and concentra-

EM 1110-2-5025

31 Jul 2015

tions. Marsh (1994) tracked sediment dispersion related to a water injection dredging project using a fluorescing particle tracer and was able to reasonably estimate areas where the dredged material was deposited, in addition to deposition rates that corresponded well to measured rates. The tracer study also proved useful one year after the study in understanding the long-term movement of the dredged material in the system.

## CHAPTER 4

### Confined (Diked) Placement

#### 4.1 Overview of Confined Placement.

4.1.1 Purpose. This chapter presents guidance for confined (diked) placement of dredged material. The terms “confined disposal facility” (CDF), “confined placement facility” (CPF), “confined disposal area,” “confined disposal site,” “diked disposal site,” and “containment area” all appear in the literature, and all refer to an engineered structure for containment of dredged material. The term “CDF” is used in this manual to describe a facility for confined (diked) placement of dredged material.

#### 4.1.1 Description.

4.1.1.1 “Confined placement” is placement of dredged material within diked nearshore or upland CDFs via hydraulic or mechanical means. A CDF is an engineered structure for containment of dredged material. They may be constructed as upland sites, nearshore sites with one or more sides in water (sometimes called intertidal sites), or island containment areas. CDFs vary considerably in size, dike type, and method of filling. Figure 4-1 illustrates the various categories of CDFs. Although the volumes vary from year to year, on the order of 35% of the total volume of material dredged to maintain Federal projects in the United States is placed in CDFs. The confinement or retention dikes or structures in a CDF enclose the placement area above any adjacent water surface, isolating the dredged material from adjacent waters during placement. This feature is what distinguishes a CDF from other forms of placement, such as unconfined upland or wetland placement, or CAD, which is a form of subaqueous capping. Confined placement, as described in this chapter, does not refer to subaqueous capping or contained aquatic disposal (guidance on subaqueous capping is presented in Chapter 3, “Open Water Placement,” of this EM).

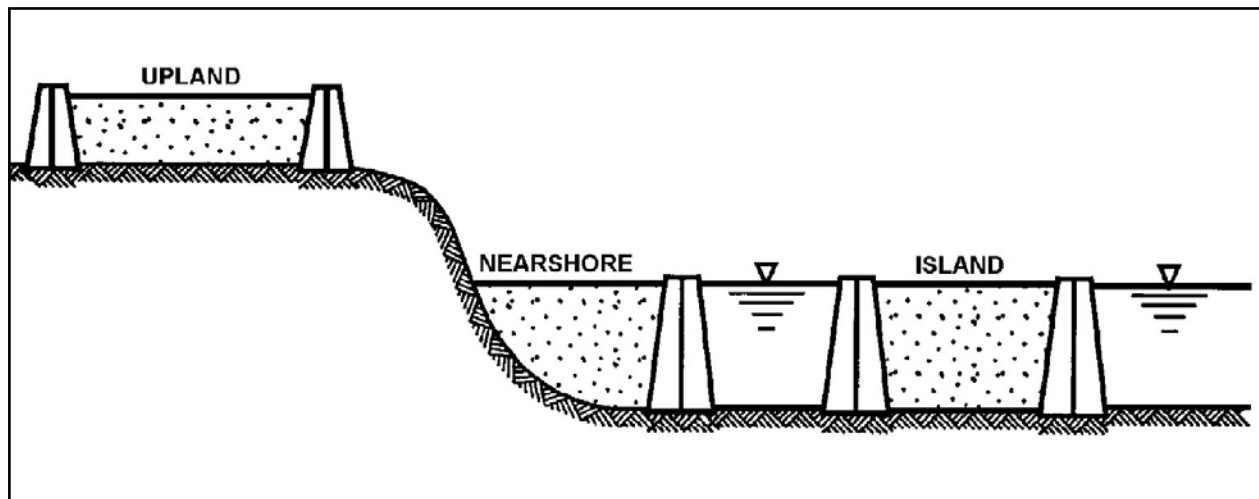

Figure 4-1. Illustration of Upland, Nearshore, and Island CDFs

31 Jul 15

4.1.1.2 Upland CDFs. Upland CDFs are one of the most common placement alternatives, and such sites exist in most regions of the United States. The use of upland CDFs is extensive in the Atlantic and Gulf Coast regions. Many of these sites were constructed in areas adjacent to estuaries or tributary rivers near the navigation channels they were intended to serve. Some of them were constructed in wetland areas (prior to wetlands protection regulations) and have been filled to become upland areas. Large upland sites, some larger than 405 ha (1,000 acres), are now in active use in the Wilmington, Charleston, Savannah, Jacksonville, Mobile, New Orleans, and Galveston Districts. CDFs initially constructed in water, which became upland sites, are located in the Great Lakes area, California, and Puget Sound. CDFs are being considered as placement options worldwide, and several large CDFs are now in active use. Figure 4-2 shows the Shelfter CDF located in Rotterdam Harbor in The Netherlands. This site was designed to meet the long-term disposal needs for the harbor and incorporates many design features for containment of the dredged material and associated contaminants.



Figure 4-2. Shelfter CDF in Rotterdam, The Netherlands

4.1.1.3 A true upland CDF allows for all dredged material fill to be placed above the water table. CDFs constructed in water may become upland sites once the fill reaches elevations above the mean high water elevation. Upland CDFs are not solid waste landfills. They are designed and constructed specifically for placement of dredged material and normally have a return flow as effluent to United States waters. A typical upland CDF is shown in Figure 4-3.



Figure 4-3. Typical Upland CDF

4.1.1.4 Nearshore CDFs. Nearshore CDFs are most numerous in the Great Lakes region of the United States. Many of these sites were constructed adjacent to entrance or harbor channels. Large nearshore sites (CDFs initially constructed in water, which became upland sites) are located in Puget Sound, the Great Lakes area, the Atlantic Coast, and California. Figure 4-4 shows a nearshore CDF with stone fill dikes. A true nearshore site takes advantage of the shoreline as a part of the containment structure for the site, with in-water dikes or other containment structures required only for the remaining walls of the total enclosure. Nearshore CDFs discussed in this chapter have dikes with crest elevations above the mean high high water elevation (MHHW). However, highly contaminated dredged material is usually placed below the MHHW elevation, and cleaner dredged material or other capping material is placed above the MHHW mark.

4.1.1.5 Island CDFs. Island CDFs are similar to nearshore CDFs except that they are constructed totally in water with no direct physical connection to the shore. Figure 4-5 shows a typical island CDF.

4.1.1.6 Technical considerations. A CDF is neither a conventional wastewater treatment facility nor a conventional solid waste disposal facility. What makes it different are the physical and chemical properties of the dredged material. Wastewater treatment facilities are designed to receive water with low levels of solids while solid waste facilities are designed to receive solids with very little water. Dredged sediments placed in CDFs typically contain 10-50% solids (dry weight basis). An effective CDF must therefore borrow features from both the wastewater treatment facility and the solid waste disposal facility in a combination that is unlike either.





Figure 4-4. Chicago Nearshore CDF



Figure 4-5. Island CDF in Tampa Bay

#### 4.1.1.7 Design objectives.

a. The objectives inherent in design and operation of CDFs are to provide for adequate storage capacity for meeting dredging requirements and to maximize efficiency in retaining the solids. CDFs are often considered as a disposal alternative for materials found to be unsuitable for open-water placement. Control of contaminant releases is a design and operation objective for these projects.

b. A principal design criterion of CDFs is to retain as high a percentage of the fine-grained sediment particles as is practicable. This principle is based on the findings of the USACE Dredged Material Research Program (DMRP), which demonstrated that most chemical contaminants associated with sediments could be contained effectively through efficient solids containment. Since most contaminants in sediment remain attached to solid particles during dredging and placement in the CDF, this process is reasonably efficient for containment of contaminants.

4.1.1.8 Existing sites versus new sites. Design and evaluation of CDF options are conducted differently, depending on whether there is an existing CDF under consideration or if a new site is required. Evaluation of an existing CDF is usually approached from the standpoint of determining if a proposed placement operation or series of operations can be accomplished at the site, considering factors such as the area available, volume to be dredged, sediment characteristics, and anticipated dredging operational parameters (such as the dredge size and flowrate,). Design of a new CDF involves determining the necessary site geometry (such as the area and dike height) and design features needed for the project.

#### 4.1.1.9 Transport and placement of dredged material.

a. A variety of hydraulic and mechanical methods can be used to place dredged material in CDFs. Direct hydraulic placement from pipeline dredges is perhaps the most common method (Figure 4-6), but material can also be placed by hydraulic pumpout directly from hopper dredges (Figure 4-7). In addition, barges filled by clamshell dredges can be hydraulically offloaded and the material pumped to CDFs. Specialized hydraulic offloaders have been designed for this purpose (Figure 4-8). Hydraulic dredging (or hydraulic reslurry) generally adds several volumes of water for each volume of sediment removed, and this excess water is normally discharged as effluent from the CDF during the filling operation. The amount of water added depends on the design of the dredge, the physical characteristics of the sediment, and operational factors, such as pumping distance.

b. Direct mechanical rehandling from barges filled by a clamshell dredge has been accomplished at CDFs in the Great Lakes region. For large dike cross sections, some sort of chute for conveyance of the material from the waterside to the interior is needed. Figure 4-9 shows an offloading sluice or chute constructed for this purpose. Figures 4-10 and 4-11 show the use of old railcar tanks grouped to form a wide chute for mechanical placement.



Figure 4-6. Typical CDF Hydraulic Inflow from a Cutterhead Pipeline Dredge



Figure 4-7. Hopper Dredge Pumpout Operation with a Pipeline Leading to the CDF





Figure 4-8. Specialized Hydraulic Offloaders



Figure 4-9. Chute Used for Direct Mechanical Placement into a CDF



Figure 4-10. Chute Fabricated from Railcar Tanks Used for Direct Mechanical Placement into a CDF



Figure 4-11. Placement Using a Chute Fabricated from Railcar Tanks for Direct Mechanical Placement into a CDF

c. Since upland sites may be located at some distance from the dredging areas and from waterfront access, placement by direct pipeline from hydraulic dredges requires routing a pipeline to the site. Material can also be transported to an upland site using roll-off containers or by truck, but a shore-based rehandling and dewatering facility may be required.

d. Nearshore sites have waterfront access by definition. Placement by direct pipeline from hydraulic dredges is feasible if the site is located near dredging areas. Material can be transported from dredging areas to a nearshore site by barge and directly off-loaded to the site by mechanical rehandling or by hydraulic reslurry operations.

e. For some nearshore sites, barges may be used to place the material directly into the CDF by bottom dumping. A notch is left in the retaining dike for barge access. This filling procedure can be used until the fill reaches a height limiting the access of the barge. The notch is then closed and the CDF filled using other methods. Bottom placement by barge dump is a hybrid between diked placement and open-water placement.

f. The method of placement influences the properties of the material in the CDF. Hydraulic filling operations may tend to segregate the various size fractions. In the case of new work dredging, sand, clay balls, and/or gravel may be present. This coarse material (>No. 200 sieve) rapidly falls out of suspension near the dredge inlet pipe, forming a mound. The fine-grained material (<No. 200 sieve) continues to flow through the containment area with most of the solids settling out of suspension, thereby occupying a given storage volume. The fine-grained dredged material is usually rather homogeneous and is easily characterized.

#### 4.1.1.10 Sizing for solids retention and initial storage.

a. A CDF must be designed and operated to provide adequate initial storage volume and surface area to hold the dredged material solids during an active filling operation and, if hydraulically filled, to retain suspended solids such that clarified water is discharged.

b. For mechanical placement operations, material placed in the CDF is at or near its in situ water content. If such sites are constructed in water, the effluent volume may be limited to the water displaced by the dredged material, and the settling behavior of the material is not as important as with hydraulic filling.

c. For hydraulic filling, the required initial storage capacity, ponded water depth, and surface area are governed by settling processes that occur in a CDF during placement of fine-grained dredged material. Settling tests of the sediments to be dredged may be required to define their settling behavior in a dredged material containment area. The tests provide numerical values for design criteria that can be projected to the size and design of the containment area. Procedures for computer-assisted plotting and reduction of settling column data are available.

d. The site must be volumetrically large enough to meet both short-term storage capacity requirements during filling operations and long-term requirements for the anticipated life of the site. Sufficient surface area and dike height with freeboard must be available for retention of fine-grained material to maintain effluent water quality. When the dredged material is initially

deposited in the CDF, it may occupy several times its original volume. The settling process is a function of time, but the sediment eventually consolidates to its in situ volume—or less if desiccation occurs. Adequate volume must be provided during the dredging operation to contain the total volume of sediment to be dredged, accounting for any volume changes during placement. Procedures to evaluate the required surface area and volume during active filling operations, to estimate effluent suspended solids concentrations, and to design other features for CDFs are described in paragraph 4.4.

4.1.1.11 Long-term management. In most cases, CDFs must be used over a period of many years, storing material dredged periodically over the design life. Long-term storage capacity of these areas is therefore a major factor in design and management. Consolidation of the layers continues for long periods following placement, causing a decrease in the volume occupied by the layers and a corresponding increase in storage capacity for future placement. Once water is decanted from the area following active placement, natural drying forces begin to dewater the dredged material, adding additional storage capacity. The gains in storage capacity are therefore influenced by consolidation and drying processes as well as the techniques used to manage the site both during and following active placement operations. All of the dredged material placed in an upland site can be dewatered by drying processes if the site is appropriately managed from the onset of operations. A nearshore or island site can be managed for dewatering by drying only for material placed above the mean high water elevation. Dewatering of material in the saturated zone is limited by consolidation processes. Procedures to evaluate long-term storage capacity and dredged material dewatering operations are described in paragraph 4.5.

4.1.1.12 Dike design. The site conditions must allow for construction of structurally and geotechnically sound retaining dikes for effective containment of ponded water and dredged material. For nearshore sites, the dike face is exposed to erosional forces due to currents and wave action, and some form of armor protection must normally be considered. Since the dikes must be constructed in water, marine construction techniques must be used, and these normally result in increased costs as compared with upland sites. Considerations for CDF dike design are presented in paragraph 4.6.

4.1.1.13 Contaminant pathways. CDFs are often an alternative for disposal of sediments found to be unsuitable for open water disposal. The sediments placed in CDFs, therefore, often contain contaminants. The possible migration pathways of contaminants from CDFs include effluent discharges to surface water during filling operations and subsequent settling and dewatering, rainfall surface runoff, leachate into groundwater, volatilization to the atmosphere, and direct uptake of contaminants by plants or animals colonizing the site (direct uptake includes plant uptake and subsequent cycling through food webs and direct uptake by animal populations living in close association with the dredged material). Effects on surface water quality, groundwater quality, air quality, plants, and animals depend on the characteristics of the dredged material, management and operation of the site during and after filling, and the proximity of the CDF to potential receptors of the contaminants. Guidance on evaluation of contaminant pathways is presented in paragraph 4.7, and guidance on control measures for contaminant releases is presented in paragraph 4.9.

#### 4.1.2 Technical Framework for CDF evaluations.

4.1.2.1 The technical framework for evaluation of dredged material placement options is described in Chapter 2, “Dredging and Navigation Project Management.” USEPA/USACE (2004) includes a framework for detailed evaluation of confined placement as an option. Figure 4-12 presents a flowchart illustrating the major steps and components of the framework.

4.1.2.2 Design aspects related to physical site capacity, such as sizing and retention of dredged material, are evaluated first because such evaluations can be conducted quickly and inexpensively. If a given site or design option is not workable from the physical standpoint, it can be eliminated without wasting effort on more involved and expensive environmental evaluations.

4.1.2.3 The evaluation of a CDF option can be approached in two basic ways. First, if there is an existing CDF or an available site for a CDF, the suitability of that site can be evaluated for the project of interest. Second, if no specific site has been identified, the requirements for the CDF can be evaluated and used to screen or select an appropriate site.

4.1.2.4 In cases where evaluations of direct physical impacts, site capacity, or contaminant pathways indicate impacts will be unacceptable when conventional CDF disposal techniques are used, management actions and contaminant control measures may be considered. Such management actions or controls may include modification to the dredging operation or site, treatment of effluent, runoff, or leachate, treatment of dredged material solids, or site controls such as surface covers or liners. Guidance on contaminant controls is presented in paragraph 4.9.

#### 4.1.3 Regulatory considerations.

4.1.3.1 The CWA Section 404(b)(1) guidelines at 40 CFR Part 230 implement environmental protection provisions of the CWA, including those related to dredged material placement in CDFs. It should be noted that the placement of dredged material in a CDF is not regulated per se under Section 404; only the discharge of dredged material to waters of the United States is regulated. Section 10 of the Rivers and Harbors Act of 1899 regulates the dredging activity but also gives the USACE regulatory authority regarding placement. Therefore, the USACE has broad regulatory authority over CDFs through both Section 10 and Section 404.

4.1.3.2 The return flow of water (effluent) from a CDF is specifically defined as a discharge to waters of the United States under Section 404 of the CWA [33 CFR 323.2]. Certain CDF effluent discharges may also be regulated under the USACE Nationwide Permit (NWP) program provided they meet the conditions for the program [33 CFR 330]. The nationwide permit would satisfy the technical requirement for a Section 404 permit for the return water where the quality of the return water is controlled by the state through the Section 401 certification procedures [33 CFR 330 Appendix A (B) (16)]. Permit applicants may contact the appropriate USACE regulatory branch to determine if a proposed activity meets the requirements for the nationwide permit. In any case, applicable State water quality standards apply to the return water, and the State 401 water quality certification requirements must be met.



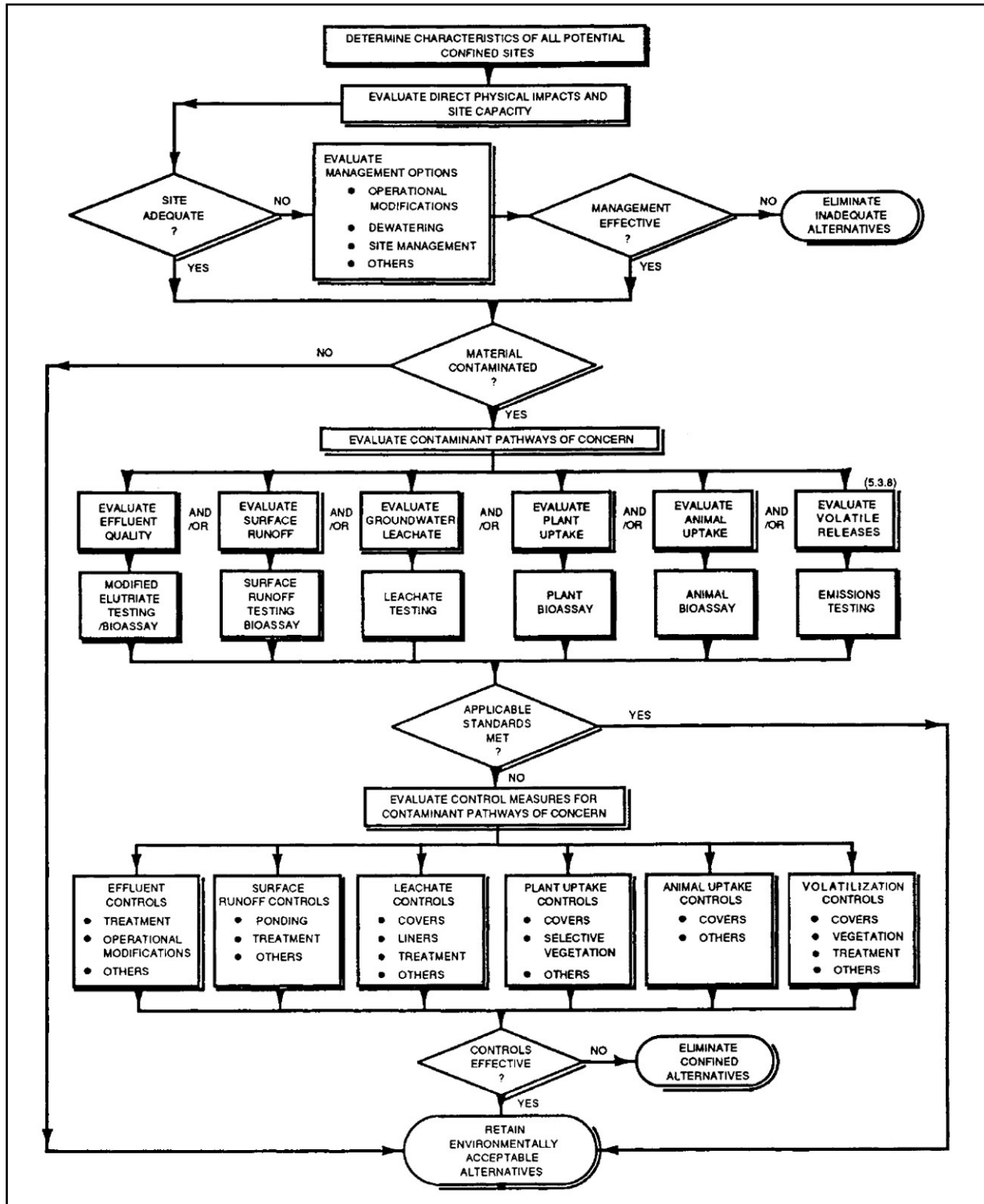

Figure 4-12. Technical Framework Flowchart for Evaluation of Confined Dredged Material Placement (after USEPA/USACE 2004)

4.1.3.3 Groundwater impacts are included among the factors in the 404(b)(1) guidelines that should be considered when evaluating the environmental protectiveness of CDFs. However, there has been much confusion regarding the applicability of solid waste regulations, specifically under the Resource Conservation and Recovery Act (RCRA), to dredged material placement in CDFs. The USEPA has specifically exempted dredged material from the Subtitle C provisions of the RCRA pertaining to disposal of hazardous wastes [FR Volume 63, Number 229, pages 65873-65947]. The exclusion in part 261.4(g) of the final rule provides that dredged material is excluded as a hazardous waste when that material is regulated under Section 404 of the Clean Water Act or Section 103 of the Marine Protection, Research and Sanctuaries Act of 1972 (MPRSA). However, no specific exemption was given under Subtitle D provisions pertaining to solid waste. It is the policy of the USACE that any placement activity in a CDF regulated under the CWA is not subject to regulation as a solid waste. If dredged material is removed from a CDF for placement off-site or for beneficial use, solid waste regulations may be applicable.

4.1.3.4 NEPA provides the USACE with a broad regulatory authority regarding selecting alternatives and the associated design, operation, and management requirements. Other CDF contaminant pathways and environmental aspects are normally considered as a part of the NEPA process.

4.1.3.5 The design, operation, and management procedures for CDFs, as described in this EM, are assumed to be applicable to CDFs regulated under Section 404.

#### 4.1.4 Technical basis for guidance.

4.1.4.1 From the brief description of CDF processes given here, it is apparent that the design, operation, and management of a CDF may become quite complex depending on the operational constraints, site conditions, and characteristics of the dredged material. A wide range of guidance documents regarding CDF design, operation, and management have been generated under the USACE Environmental Effects of Dredging Programs (EEDP) at the U.S. Army Engineer Research and Development Center (ERDC) and through various site-specific studies by USACE Districts and Divisions. These efforts provide the foundation for the technical guidance on CDFs found in this EM.

4.1.4.2 The Dredged Material Research Program (DMRP) was the first major research effort of the USACE addressing dredged material placement, and confined placement was addressed within several research areas of the program. DMRP research results provided the basis for initial USACE technical guidance on confined dredged material placement, including design, operation, management, basic consideration of contaminant behavior, approaches for dewatering, and reuse and productive use of CDFs (Palermo, Montgomery, and Poindexter 1978; Haliburton 1978).

4.1.4.3 Following the DMRP, research under the Field Verification Program (FVP) and Long-Term Effects of Dredging Operations (LEDO) Program and technology transfer efforts under the Dredging Operations Technical Support (DOTS) Program have led to the development of a variety of technical reports, technical notes, EMs, and other guidance documents related to confined placement. In 1987, EM 1110-2-5027 was published as a comprehensive guidance document on the engineering aspects of confined placement design and management. This EM

was based on the technical guidance developed during and subsequent to the DMRP. However, the EM was purposely focused on the engineering design of CDFs and did not include guidance on the environmental aspects of confined placement, particularly those aspects related to contaminant pathway testing and assessment and design of control measures for contaminants.

4.1.4.4 The technical framework for the evaluation of dredged material placement options developed by the USACE and USEPA (USEPA/USACE 2004) includes a framework for detailed evaluation of confined placement as an option. The guidance for CDF options provided in this EM includes contaminant pathway testing and assessment and design of control measures for contaminants as called for in the Technical Framework (Figure 4-12). Many of the technical reports are available through the USACE DOTS website (<http://el.erdc.usace.army.mil/dots/>).

## 4.2 Site Selection and Investigations.

### 4.2.1 Site selection considerations.

4.2.1.1 Site specification for CDFs can be more complex in many ways than for open-water sites. Real estate considerations are a major factor in determining the availability of potential sites. Most navigation project authorizations require local project sponsors to provide the lands, easements, and rights-of-way for CDFs; some authorizations require the sponsor to provide dikes and site management. CDFs, therefore, represent a substantial economic investment on the part of the sponsor. In many instances, the sponsors provide only sites that meet short-term requirements, and additional sites may be required in the future. Another consideration for CDF site specification is the fact that such sites are normally visible to the public and are viewed as a competing interest for land use, especially in coastal areas where there is intense pressure for both development and preservation of lands.

4.2.1.2 A knowledge of CDF site characteristics is necessary for assessments of potential physical impacts and contaminant impacts. Information on site characteristics needed for assessments includes the following:

a. Available area and volumetric storage capacity to contain the material for the required life of the site.

b. Real estate considerations.

c. Site configuration and access.

d. Proximity to sensitive ecological environments.

e. Topography to include potential changes in elevation and runoff patterns and adjacent drainage.

f. Ability of the dredged material to eventually dry and oxidize.

g. Groundwater levels, flow and direction, and potential impact on groundwater discharge and recharge.



- h. Meteorology and climate.
- i. Foundation soil properties and stratigraphy.
- j. Potential groundwater receptors.
- k. Potential alteration of the existing habitat type.
- l. Potential for effluent, leachate, and surface runoff impacting adjacent ground and surface water resources.
- m. Potential for direct uptake and movement of contaminants into food webs.
- n. Potential for volatilization of contaminants.
- o. Potential for dust, noise, or odor problems.
- p. Potential to implement management activities when deemed necessary.
- q. Potential accessibility of the site by the public.
- r. Contamination history of proposed site.

4.2.2 Site surveys and investigations. Field exploration programs are necessary to assess many of the above considerations in determining the suitability of a site for use as a CDF. The sediments to be dredged must be characterized, and the CDF site should be investigated to include foundation explorations for dike design and groundwater assessments.

4.2.2.1 Channel sediments. As with any placement option, investigations of channel sediments are needed to determine volumes to be dredged and the physical and chemical characteristics of the sediments. The channel must be surveyed to determine the volume of material to be dredged, and channel sediments must be sampled to obtain material for laboratory tests. The potential for the presence of contaminants should be evaluated when planning field investigations, and appropriate safety measures should be considered. Determination of the in situ density (water content) of the sediment is especially critical for sizing a CDF to accommodate the volume to be dredged. Samples from multiple stations in the area to be dredged are normally collected for purposes of characterization, while composite samples are developed for some engineering and environmental testing. Details on channel surveys and sediment sampling and characterization are provided in Chapter 2, "Dredging and Navigation Project Management," of this EM.

#### 4.2.2.2 CDF site investigations.

a. Some site investigations are required to obtain data for site screening and selection. However, detailed and expensive investigations are normally limited to a feasible site or sites or to an existing site if sufficient data is not available.

b. Site investigations must be conducted to provide information for dike design and evaluation of potential foundation settlement, an important parameter in long-term storage capacity estimates.

c. Field investigations must be performed at the containment area to define foundation conditions and to obtain samples for laboratory testing if estimates of long-term storage capacity are required. The extent of required field investigations is dependent upon both the project size and the foundation conditions at the site. It is particularly important to define foundation conditions (including depth, thickness, extent, and composition of foundation strata), groundwater conditions, and other factors that may influence construction and operation of the site. For new containment areas, the field investigations required for estimating long-term storage capacity should be planned and accomplished along with those required for the engineering design of the retaining dikes, as described in paragraph 4.6.

d. For existing containment areas, the foundation conditions may have been defined by previous subsurface investigations made in connection with dike construction. However, previous investigations may not have included sampling of compressible soils for consolidation tests; in most cases, suitable samples of any previously placed dredged material would not be available. Field investigations must therefore be tailored to provide those items of information not already available.

e. Undisturbed samples of the compressible foundation soils can be obtained using conventional soil sampling techniques and equipment. If dredged material has previously been placed within the containment area, undisturbed samples must be obtained from borings taken within the containment area but not through existing dikes. The major problem in sampling existing containment areas is that the surface crust does not normally support conventional drilling equipment, and personnel sampling in these areas must use caution. Below the surface crust, fine-grained dredged material is usually soft, and equipment sinks rapidly if it breaks through the firmer surface. Lightweight drilling equipment, supported by mats, is normally required if crust thickness is not well developed. In some cases, sampling may be accomplished manually if sufficient dried surface crust has formed to support crew and equipment. More detailed information regarding equipment use in containment areas is presented in Appendix O, "Procedures for Selecting Equipment for Dewatering Operations."

f. Water table conditions within the containment area must be determined in order to estimate loadings caused by placement of dredged material. This information must be obtained by means of piezometers, which may also be used to measure groundwater conditions during the service life of the area. Other desired instrumentation, such as settlement plates, may also be installed within the containment area for monitoring various parameters.

g. Additional information regarding conventional sampling techniques and equipment and development of field exploration programs is given in EM 1110-2-1907 and in Chapter 2, "Dredging and Navigation Project Management," of this manual. Procedures for installation of piezometers and other related instrumentation are given in EM 1110-2-1908.

#### 4.2.3 Site selection for avoidance of contaminant impacts.

4.2.3.1 As water percolates through in situ dredged material, leachate may be produced. This leachate water may be the result of precipitation or entrained water caused by the dredging operation. Available data for the characterization of leachate produced from dredged material are very limited. Potential adverse water quality impacts are most likely caused by the increase of chloride, potassium, sodium, calcium, total organic carbon, alkalinity, iron, and manganese. These factors should be considered even for dredged material that is thought to be uncontaminated. This is especially true if a saltwater dredged material may be placed over a freshwater aquifer.

4.2.3.2 Site location is an important, if not the most important, consideration in minimizing any adverse impact to underlying groundwater. Selection of a technically sound site may reduce or eliminate the need for any restrictions or controls. Site characteristics affecting groundwater impacts are presented in Table 4-1. Those that are particularly important in the evaluation of groundwater impacts at potential upland placement sites are discussed in the following paragraphs.

Table 4-1. Site Characteristics Affecting Groundwater Impacts

Characteristic	Impact
Site volume	Depth to bedrock
Site area	Depth to aquicludes
Site configuration	Direction and rate of groundwater flow
Dredging method	Existing land use
Climate (precipitation, temperature, wind, evaporation)	Depth of groundwater
Soil texture and permeability	Ecological areas
Soil moisture	Drinking water wells
Topography	Receiving streams (lakes, rivers, etc.)
Drainage	Level of existing contamination
Vegetation	Nearest receptors

a. Location. While the significant characteristics of a given site are usually unique, useful hypotheses about pathways of migration and estimates of parameters needed to calculate migration rate can often be developed from available regional data and keyed to location, topography, surface drainage patterns, flood potential, subsurface stratigraphy, groundwater flow patterns, and climate.

b. Topography. Topographic variables are important in evaluating surface drainage and run-on and runoff potential of the site. This information is helpful in determining the amount of water that may be available to percolate through the in situ dredged material.

c. Stratigraphy. The nature of subsurface soils, determined by examination of soil core borings to bedrock, is an important input to evaluation of pathways of migration in both the unsaturated and saturated zones.

d. Groundwater levels (equipotential surfaces). Seasonal maps of water table contours and piezometric surfaces, developed by analysis of groundwater monitoring well data, are important in predicting groundwater flow directions and hydraulic gradients, as these can vary greatly at upland or nearshore sites.

e. Groundwater flow. Information on permeability and porosity of subsurface strata, combined with data on hydraulic gradients, is important in predicting groundwater flow velocities and direction.

f. Meteorology and climate. Precipitation, including annual, seasonal, or monthly rain and snowfall, is an important parameter in determining a water balance for the site and in evaluating leachate potential. Evapotranspiration is also important in developing a water balance for the site. It is often estimated from temperature and the nature of vegetative growth at the site.

g. Soil properties. An important variable in evaluating mobility of many metal contaminants is pH. Cation exchange capacity (CEC), a measure of the reversibly bound cations in a sample, is an important determinant of the mobility of metallic species in soils; if the CEC is sufficiently high to adequately immobilize the heavy metals present in the soil, no adverse groundwater impacts may result. Redox potential (Eh) is important in determining the stability of various metallic and organic species in the subsurface environment of the site. Organic carbon content is a major variable affecting adsorption, and therefore mobility, of organic species in the subsurface environment. Soil type (for example, clay, till, sand, and fractured bedrock) is a major variable affecting rates and routes of groundwater migration.

h. Potential groundwater receptors and sensitive ecological environments. Groundwater and surface water usage, especially downgradient of the site, is important in evaluating adverse impacts. Size of population and nature of ecological resources downgradient of the site are also important variables in determining adverse impacts.

4.2.3.3 Examples of where site location alone can be used to reduce or eliminate adverse impacts to groundwater include the following:

a. Selection of sites that have natural clay underlying formations that can minimize potential groundwater contamination concerns.

b. Selection of sites to avoid aquifer recharge areas that can minimize potential groundwater contamination concerns. Another consideration associated with site location is that some fine-textured dredged material tends to form its own liner as particles settle with percolation drainage water; however, it may require considerable time for self-sealing to develop. For this reason, if an artificial liner is considered useful, a temporary liner subject to gradual deterioration with time may be adequate in many cases.

4.2.4 Considerations for dike alignment and location of weirs and inflows. Once a site has been identified for a new CDF, the available area for construction of that CDF can be evaluated with respect to the potential location (alignment) of the dikes, inflow points, and outlet weirs. In general, the geometry of the diked area should be laid out such that the distance between the inflow points and outlet weirs is maximized. The geometry should also consider the potential hydraulic efficiency of the site. The anticipated weir and inflow locations should also be considered early in the design/evaluation process for existing sites. In some cases, the weirs may require relocation or upgrading, or additional weirs may need to be added.

### 4.3 Laboratory Testing Requirements.

#### 4.3.1 General.

4.3.1.1 A number of laboratory tests may be required to provide data for CDF design and evaluation. In some cases specific tests, designed for dredged material application, are needed. If CDF options are being considered along with other placement and management options, the laboratory testing program should be planned to meet the testing requirements pertaining to all options under consideration (see Chapter 2, “Dredging and Navigation Project Management”).

4.3.1.2 The types of tests that should be considered for CDF evaluations include those for sediment characterization, settling tests for containment area design, consolidation tests for long-term storage capacity estimates, and contaminant pathway tests. The laboratory tests and procedures include standard tests that generally follow procedures found in Standard Methods for the Examination of Water and Wastewater (American Public Health Association [APHA] 1998), EM 1110-2-1906, and the Upland Testing Manual (UTM) (USACE 2003), used primarily for contaminant pathway testing. The anticipated requirements for the total testing program should be considered in planning any required sampling and in scheduling the testing efforts. Sampling and testing should be conducted in a coordinated program to avoid multiple sampling and testing efforts to the degree possible.

4.3.1.3 The required magnitude of the laboratory testing program is highly project dependent. Fewer tests are usually required when dealing with a relatively homogeneous material and/or when data are available from previous tests and experience. This is frequently the case in maintenance work. For unusual maintenance projects where considerable variation in sediment properties is apparent from samples or for new work projects, more extensive laboratory testing programs are required. Laboratory tests should always be performed on representative samples selected using sound engineering judgment. The potential presence of contaminants should be evaluated when planning a laboratory testing program, and appropriate safety measures should be considered.

4.3.1.4 In some cases, recurring maintenance dredging is performed on given channel reaches. Laboratory test data from previous sampling efforts may be available. Under such conditions, sediment characterization tests may be the only laboratory testing required. For example, additional settling tests or consolidation tests are not required if it has been satisfactorily determined by prior testing that the settling and consolidation properties of the sediment to be dredged have not changed.

#### 4.3.2 Physical/Engineering tests.

4.3.2.1 General. Several physical and engineering tests may be required for design of the CDF for initial and long-term capacity. Sediment characteristics and requirements for settling data and for long-term storage capacity estimates dictate which laboratory tests are required.

4.3.2.2 In situ density/water content. Data defining the water content or density of the sediment in situ in the channel prior to dredging are critical for CDF design. Tests to define the water content should be conducted on multiple samples taken throughout the area to be dredged and vertically within the full thickness of the shoal to be removed.

4.3.2.3 Column settling tests. Dredged material placed in placement areas by hydraulic dredges or pumped into placement areas by pump-out facilities enters the placement area as a slurry (mixture of dredged solids and dredging site water). Settling refers to those processes in which the dredged material slurry is separated into supernatant water of low solids concentration and a more concentrated slurry. Laboratory sedimentation tests provide data for designing the containment area to meet effluent suspended solids criteria and to provide adequate storage capacity for the dredged solids. Detailed descriptions of the settling processes involved in CDF design and column settling test procedures are provided in paragraph 4.4 and Appendix H, "Column Settling Test Procedures."

4.3.2.4 Consolidation testing. Determination of containment area long-term storage capacity requires estimates of settlement due to self-weight consolidation of newly placed dredged material and due to consolidation of compressible foundation soils. Consolidation test results must be obtained, including time-consolidation data, to estimate the average void ratios at completion of 100% primary consolidation.

a. Consolidation tests for foundation soils should be performed as described in EM 1110-2-1906.

b. Controlled-rate-of-strain tests or fixed-ring consolidometers should be used for consolidation testing of sediment samples because of their fluidlike consistency. The only major modifications for the conventional fixed-ring testing procedure concern the sample preparation and the method of loading. Detailed procedures are found in Appendix J, "Dredged Material Consolidation Test Procedures."

4.3.2.5 Contaminant pathway tests. The potential contaminant pathways for CDFs include effluent during filling, surface runoff, leachate to groundwater or surface water, plant and animal uptake, and volatilization to the air. Tests to evaluate each of these pathways have been developed specifically for dredged material. However, contaminant pathway testing need not be conducted for all projects. As shown in the flowchart in Figure 4-12, illustrating the testing framework, screening evaluations should be initially conducted to determine if a specific pathway is of concern. Pathway tests would then be conducted for only those pathways of concern. More details on pathway analysis is provided in paragraph 4.7. Detailed procedures on the various pathway tests are provided in the Upland Testing Manual (USACE 2003).

#### 4.4 Retention of Solids and Initial Storage.

##### 4.4.1 General.

4.4.1.1 One of the primary design objectives for a CDF is the retention of the dredged material solids and the storage of the total volume of dredged material to be removed from the active dredging operation. The design of a CDF for retention and initial storage is critical for the case of hydraulic filling because the volumes of material undergo significant change during the hydraulic dredging and placement process, and the solids must settle out from the carrier water to maintain effluent quality. Guidelines presented here provide the necessary procedures for “sizing” a containment area for adequate space and volume for retaining the solids within the containment area through settling and providing storage capacity of dredged solids for a single dredged material placement operation. Sizing to meet the initial capacity requirement does not meet the needs for long-term storage capacity considering multiple filling operations, consolidation, and dewatering (this aspect of CDF design is discussed in paragraph 4.5).

4.4.1.2 If a CDF is filled by rehandling from mechanically filled barges or by trucking operations from rehandling facilities at another location, suspended solids retention is not normally a design consideration and initial storage requirements can be determined in a straightforward manner since any volume changes would be minor. The procedures in this chapter, therefore, focus on the design requirements for hydraulic filling.

4.4.1.3 Hydraulic filling involves pumping a dredged material slurry, which is a mixture of suspended solids and carrier water, into the CDF. Direct placement of dredged material using pipeline dredges, pumpout of hopper dredges, and hydraulic reslurry of material from mechanically filled barges are all forms of hydraulic filling. If sufficient surface area or volume of ponded water is not maintained in the site during hydraulic filling, the suspended solids will not be retained and effluent quality will be degraded. If sufficient volume for storage of settled solids is not provided, the dredging operation must be interrupted until additional settling occurs or it may be impossible to place the full volume in the site without raising the dikes.

4.4.1.4 The major components of a hydraulically filled CDF are shown schematically in Figure 4-13. Constructed dikes form a confined surface area, and the dredged channel sediments are pumped into this area hydraulically. Both the influent dredged material slurry and effluent water can be characterized by suspended solids concentration, suspended particle size gradation, type of carrier water (fresh or saline), and rate of flow. The clarified water is usually discharged from the containment area over a weir. Effluent flow rate is approximately equal to influent flow rate for continuously operating placement areas. Flow over the weir is controlled by the static head and the weir length provided. To promote effective sedimentation, ponded water is maintained in the area with the depth of water controlled by the elevation of the weir crest. The thickness of the dredged layer increases with time until the dredging operation is completed. Minimum freeboard requirements and mounding of coarse-grained material result in a ponded surface area smaller than the total surface area enclosed by the dikes. Dead spots in corners and other hydraulically inactive zones reduce the surface area effectively involved with the flow to considerably less than the total ponded surface area.

31 Jul 15

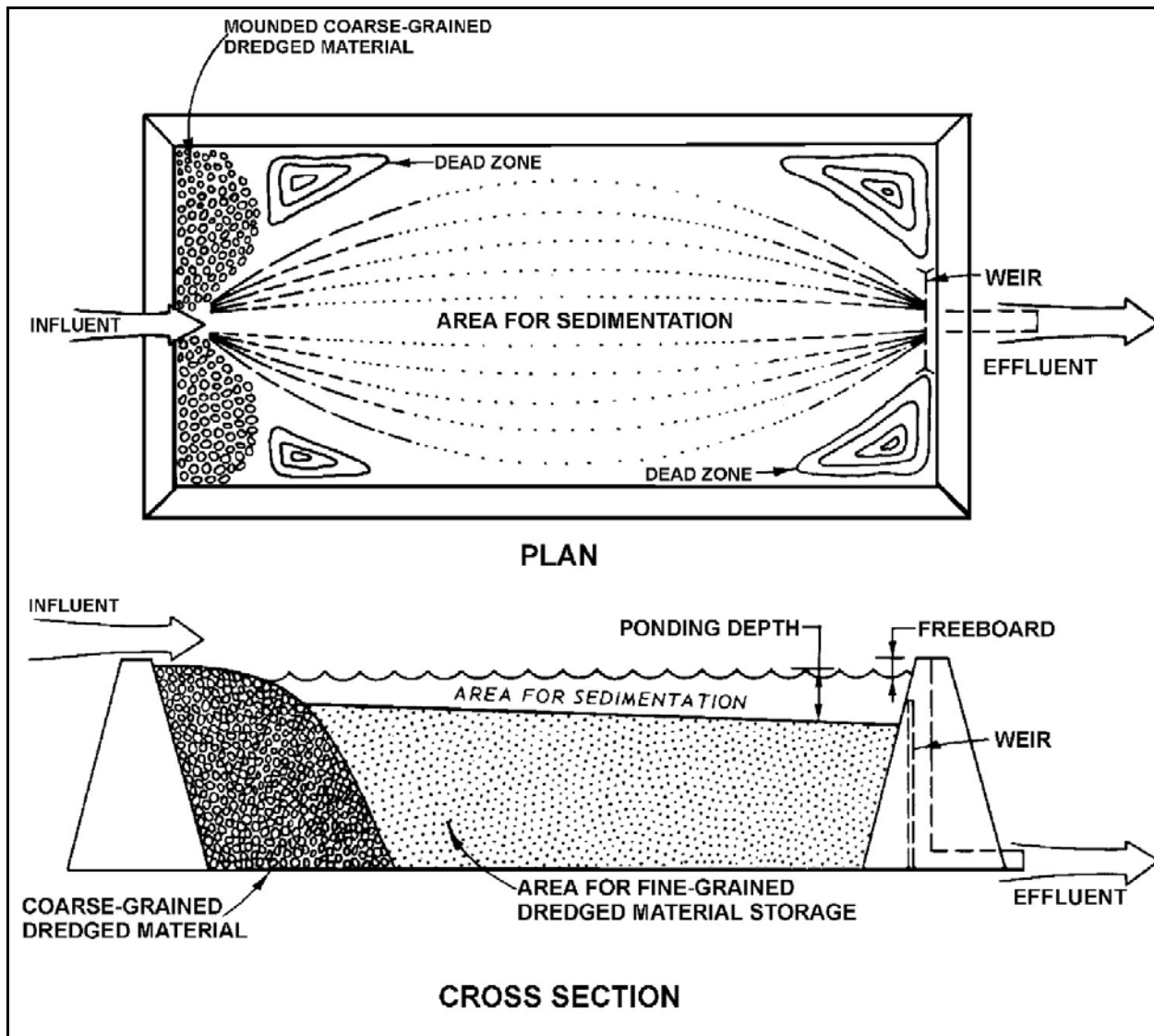

Figure 4-13. Conceptual Diagram of a Dredged Material Containment Area

4.4.1.5 The focus in this chapter is on fine-grained dredged material, the silt and clay fraction. The major objective is to provide solids removal by the process of gravity settling to a level that permits discharge of the transporting water from the area. The coarse fraction, the sand and larger particles, do not undergo significant volume change and easily settle out near the inflow point.

4.4.1.6 Effluent standards may be imposed as a requirement for water quality certification. Standards in terms of suspended solids or turbidity may be used. Procedures in this manual allow containment areas to be designed to meet such effluent standards.

4.4.1.7 The process of gravity sedimentation does not completely remove the suspended solids from the containment area effluent since wind and other factors resuspend solids and increase effluent solids concentration. The settling process, with proper design and operation, normally provide removal of fine-grained dredged material down to a level of 1-2 grams per liter



in the effluent for freshwater conditions. The settling process usually provides removal of fine-grained dredged material down to a level of several hundred milligrams per liter or lower for saltwater conditions. If the required effluent standard is not met by gravity settling, the designer must provide for additional treatment of the effluent (for example, flocculation or filtration) (paragraph 4.8).

4.4.1.8 The overall design approach is illustrated in the flowchart in Figure 4-14. Pertinent data on dredging volumes, CDF site conditions, dredged material characteristics, and basic design assumptions are initially evaluated. An initial screening evaluation is then conducted to determine the need for settling column tests and detailed design calculations. If the actual or anticipated size of the CDF is much larger than necessary for the dredging project under consideration and contaminants are not an issue for effluent quality, no column tests are needed. An option is also available for “small projects” to determine the sizing requirements using conservative approaches, but the time and expense of testing and design calculations can be avoided. Otherwise, column settling test data should be used in performing detailed evaluations of the sizing requirements.

#### 4.4.2 Data requirements and initial evaluation.

4.4.2.1 General. The data required to size a CDF for solids retention and initial storage are obtained from field investigations (Chapter 2, “Dredging and Navigation Project Management”), laboratory testing (Chapters 2 and 4), project-specific operational constraints, and experience in dredging and placement activities. The types of data required are described in the following paragraphs.

4.4.2.2 In situ sediment volume. The initial step in any dredging activity is to estimate the total in situ channel volume of sediment to be dredged,  $V_c$ . Sediment quantities are usually determined from routine channel surveys (Chapter 2).

4.4.2.3 Physical characteristics of sediments. Field sampling and sediment characterization should be accomplished according to the laboratory tests described in Chapter 2 of this manual. Adequate sample coverage is required to provide representative samples of the sediment. Also required are in situ water contents of the fine-grained maintenance sediments. Care must be taken in sampling to ensure that the water contents are representative of the in situ conditions. A representative value for in situ void ratios is needed to estimate volume for the containment area. Grain size analyses are used to estimate the quantities of coarse- and fine-grained material in the sediment to be dredged. The volume of sand  $V_{sd}$  can be estimated as a percentage of the total volume  $V_c$  to be dredged by using the percent coarser than No. 200 sieve. The in situ volume of fine-grained sediment  $V_i$  is equal to  $V_c - V_{sd}$ .

4.4.2.4 Salinity of carrier water. In addition to physical characteristics of the sediment, the salinity of the water at the dredging site should be determined. The near bottom salinity is reflected in the dredged material pumped directly to the CDF by pipeline or by hopper dredge pumpout. For reslurry of mechanically dredged material from barges, the salinity of the reslurry water at the point of offloading should be considered.

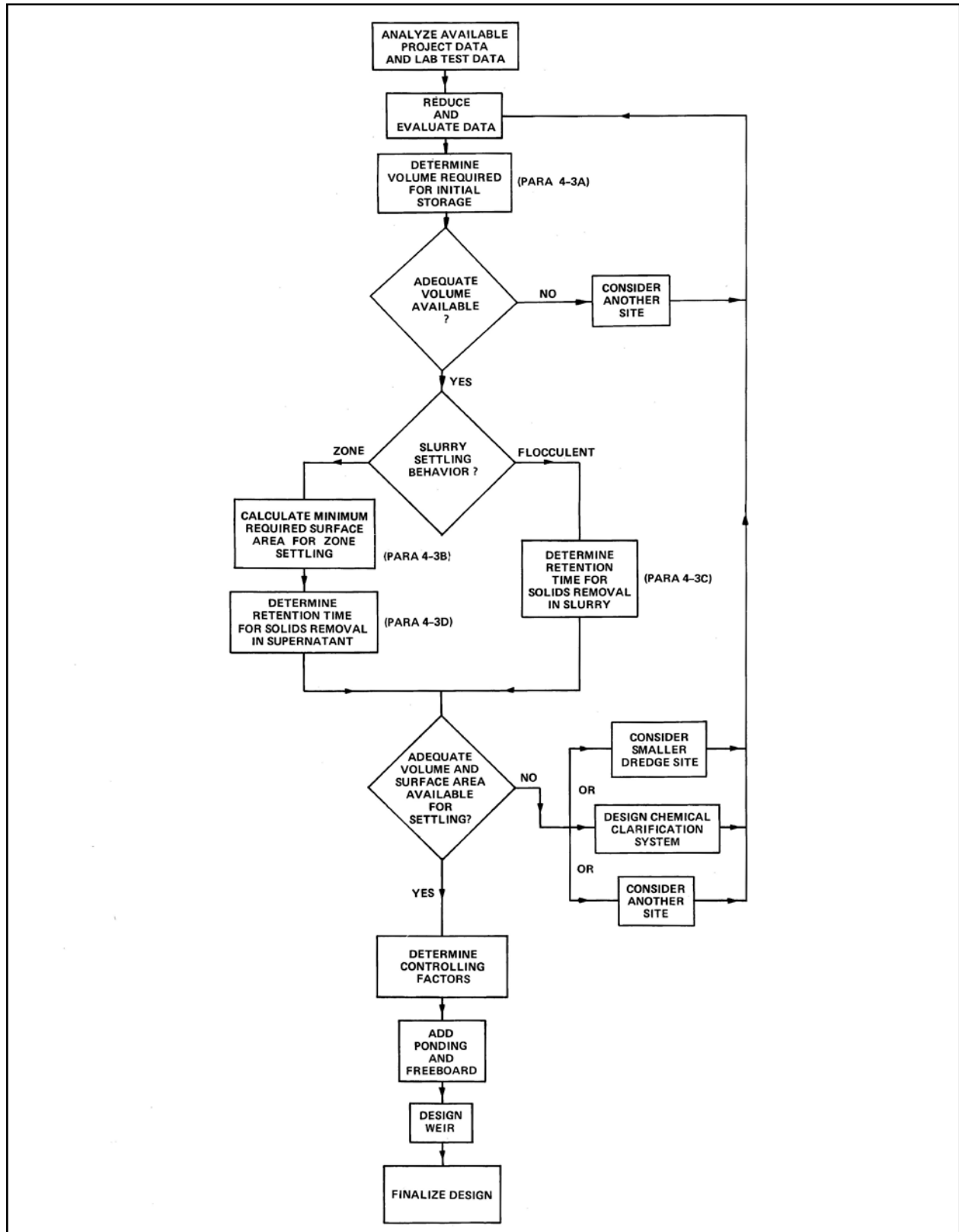

Figure 4-14. Flowchart of the Design Procedure for Settling and Initial Storage

4.4.2.5 Available placement site area and volume. The sizing effort determines if the area and volume of an existing site are adequate for the project under consideration or if a new site is needed. In the latter case, it determines the required dimensions of a new site, considering both the surface area and the dike height needed to provide the required volume. The diked surface area and available volume within the diked area for existing sites must be estimated. The evaluations determine the needed surface area and volume, and these requirements can be compared to available area and volume for either new or existing sites. If the project requires construction of new dikes or raising existing dike elevations, the limitations on dike heights should be determined considering the foundation conditions or other factors.

4.4.2.6 Dredging flowrate and time required for filling. The largest anticipated hydraulic inflow rate during filling and the estimated time required to complete the entire filling operation must also be determined. Inflow rate is a function of the dredge size, and the time required for dredging the project is a function of the production rate of the dredge and other associated factors. In many cases, the pipeline dredge size or equivalent flowrate for hopper or barge off-loading can be estimated from past experience with the project. If the size of the dredge to be used is not known, the largest dredge size that might be expected to perform the dredging should be assumed. For hopper dredge or barge pump-out operations, an equivalent placement rate must be estimated based on hopper or barge pump-out rate and travel time involved. Flowrates for various dredge sizes and methods for estimating the production rates and times required to complete an active dredging project are provided in Chapter 2, "Dredging and Navigation Project Management."

4.4.2.7 Selection of minimum average ponding depth. Before a placement site can be designed for effective settling or before the required placement area geometry can be finalized, a ponding depth  $H_{pd}$  during placement must be assumed. The design procedures in the following paragraphs call for an average ponding depth in estimating the residence time necessary for effective settling. A minimum average ponding depth of 0.6 m (2 ft) should be used for the design. If the design objective is to minimize the surface area required, selection of a deeper ponding depth may be desirable. If conditions allow for the greater ponding depth throughout the operation, the greater value can be used. For most cases, constant ponding depth can be maintained by raising the pond surface as settled material accumulates in the containment area by raising the elevation of the weir crest. Although ponding is not feasible over the entire surface area of many sites, an adequate ponding depth must be maintained over the design surface area as determined by the design to ensure adequate retention of solids.

4.4.2.8 Effluent standards. The standards for effluent turbidity (TSS) must be considered in sizing the CDF for retention time and any need for additional control measures to reduce suspended solids concentrations in the effluent.

4.4.2.9 Initial screening evaluation. Once the basic project data and design requirements are collected, an initial screening evaluation can be conducted to determine the need for laboratory column settling tests and detailed design evaluations.

4.4.2.10 Small CDFs can be sized for solids retention and initial storage using nomograph solutions. The available nomographs are based on conservative assumptions, and the resulting

designs are conservative, but the time and expense of testing and design calculations can be avoided. The CDF can be sized using these nomographs if certain conditions are met.

#### 4.4.3 Column settling tests.

4.4.3.1 If the initial evaluation indicates a detailed design evaluation for solids retention and initial storage is required, column settling test data are needed for the evaluation. The required initial storage capacity and surface area are governed by zone, flocculant, and compression settling processes that occur in a CDF during placement of fine-grained dredged material. Depending on the salinity of the carrier water and the concentration of the inflow to the CDF, the dredged material slurry settles either by zone processes (common for saltwater sediments) or by flocculant processes (common for freshwater sediments). Regardless of the salinity, flocculant processes govern the concentration of solids in the effluent.

4.4.3.2 If data exist from previous column settling tests that are representative of the dredged material under consideration, the previous data can be used. For new projects or changed project conditions or material characteristics, new column tests are necessary. The settling column used for the test is shown in Figures 4-15 and 4-16. The column is 20 cm (8 in.) in diameter and 1.8 m (6 ft) high, and the test is commonly called a “long tube” settling test. Even though zone, flocculant, and compression settling data are needed, all the data can be developed from a single test. A composite sediment sample is commonly used for the test (see Chapter 2, “Dredging and Navigation Project Management”). A detailed description of the settling processes and the procedures for conducting the settling test are given in Appendix G, “Plans and Specifications for Settling Column,” and Appendix H, “Column Settling Test Procedures.”

4.4.3.3 The column settling test results are normally used to develop relationships for effluent TSS versus retention time, average concentration (or density) of the dredged material placed in the CDF as a function of total dredging time, and minimum required surface area for effective zone settling as a function of inflow rate. These relationships can then be used in determining the sizing requirements for a new CDF or the adequacy of an existing CDF to meet the project requirements.

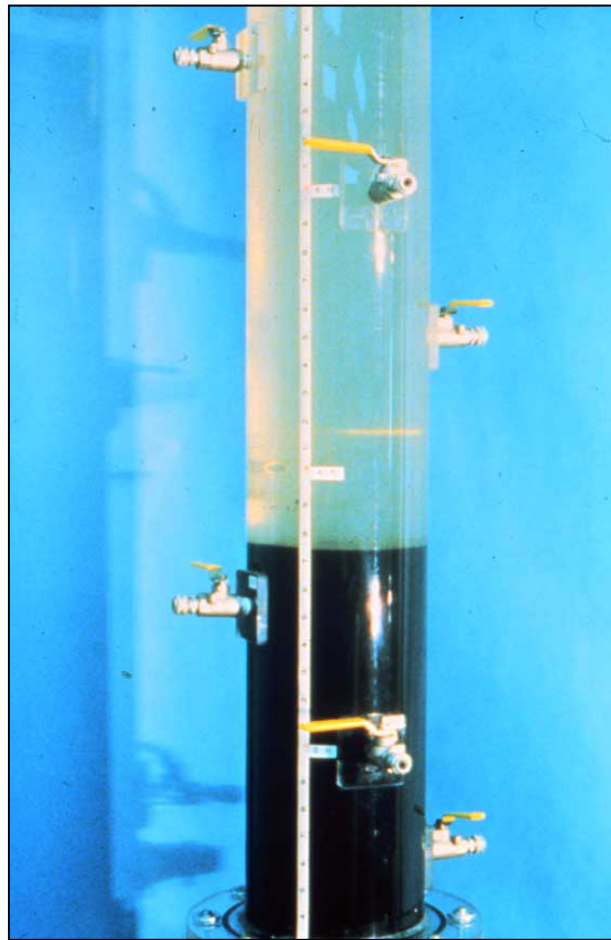

Figure 4-15. Settling Column Test

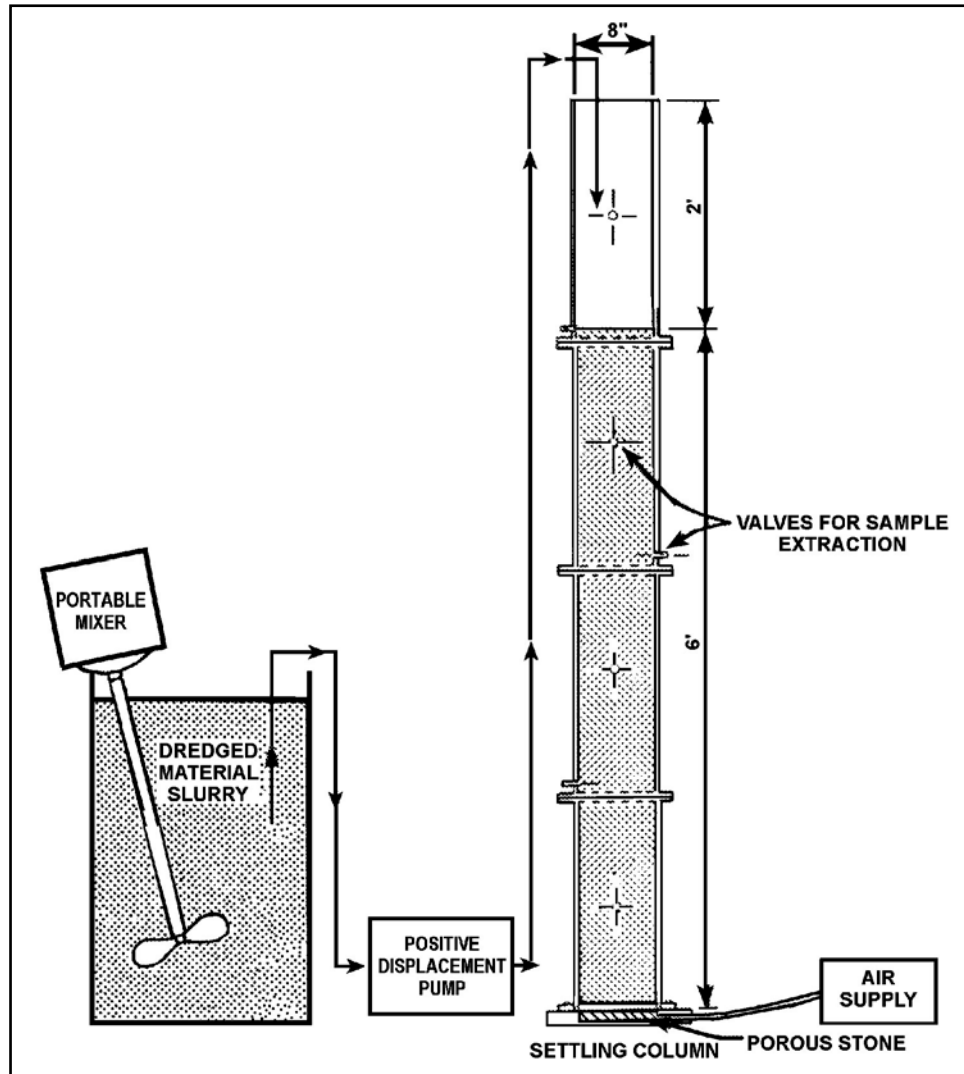

Figure 4-16. Schematic of an Apparatus for Conducting Settling Tests

#### 4.4.4 Sizing calculations.

4.4.4.1 General. Design calculations for solids retention and initial storage can be done manually or by computer. The calculations determine the following:

- a. Volume for initial storage.
- b. Minimum surface area for effective zone settling.
- c. Required retention time to meet effluent TSS standards.

4.4.4.2 Evaluation of sizing. Once the basic design requirements are known and column settling test data is available, the detailed evaluation of sizing for solids retention and initial storage can be approached in several ways:

a. New site. The minimum required surface area for zone settling, surface area for initial storage, and effluent TSS can be calculated for an assumed inflow rate.

b. Existing site. Required dike heights, allowable inflow rates, and effluent TSS concentrations can be estimated for an existing site with defined surface area and assumed average ponding depth.

4.4.4.3 Computer solution. An application of the ADDAMS system, Design of Confined Disposal Facilities for Suspended Solids Retention and Initial Storage Requirements (SETTLE), provides a computer program to assist in the design of a CDF for solids retention and initial storage. Laboratory column settling tests are an integral part of these design procedures, and the data from these tests are required in order to use this application. The SETTLE application analyzes laboratory data from the settling tests and calculates design parameters for CDFs. Descriptions of ADDAMS and SETTLE are presented in Appendix F, “Automated Dredging and Disposal Alternatives Modeling System (ADDAMS).”

4.4.4.4 Manual calculations. The necessary calculations can also be done manually, following the procedures given in Appendix I, “Design Calculations for Retention of Solids and Initial Storage.” Example calculations are also presented in this appendix.

#### 4.4.5 Weir design for solids retention.

4.4.5.1 Weir design and operation. The purpose of the weir structure is to regulate the release of ponded water from the containment area. Proper weir design and operation can control resuspension and withdrawal of settled solids.

4.4.5.2 Weir design and containment sizing. Weir design is based on providing the capability for selective withdrawal of the clarified upper layer of ponded water. The weir design guidelines, as developed in the following paragraphs, are based on the assumptions that the design of the containment area has provided sufficient area and volume for sedimentation and that shortcircuiting is not excessive.

4.4.5.3 Ponding depth and effective weir length. Ponding depth and effective weir length are the two most important parameters in weir design. The weir design guidelines presented in this section allow evaluation of the trade-off involved between these parameters. The relationship between effective weir length and ponding depth necessary to discharge a given flow without significantly entraining settled material is illustrated by the nomograph in Figure 4-17.

a. Ponding depth. In order to maintain acceptable effluent quality, the upper layers containing low levels of suspended solids should be ponded at depths greater than or equal to the minimum depth of the withdrawal zone in order to prevent scouring settled material. The withdrawal zone is the area through which fluid is removed for discharge over the weir, as shown in Figure 4-18. The size of the withdrawal zone affects the approach velocity of flow toward the weir and is generally equal to the depth of ponding.

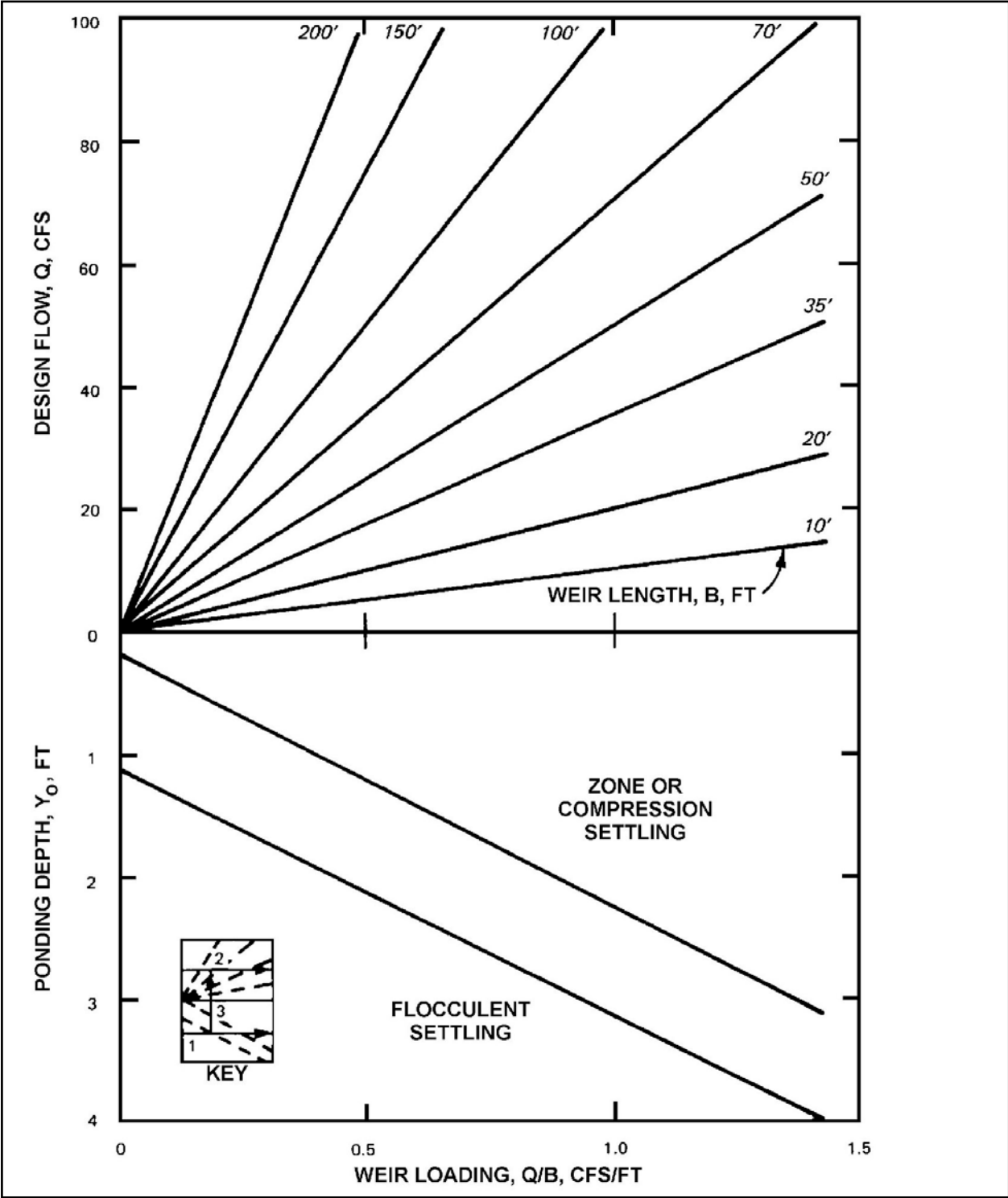

Figure 4-17. Weir Design Nomograph

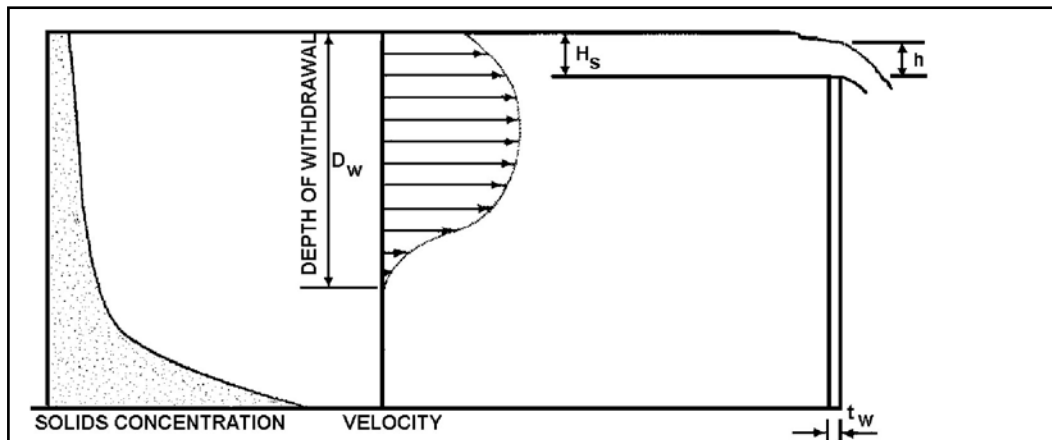

Figure 4-18. Conceptual Illustration of Withdrawal Depth and Velocity Profile

b. Effective weir length. The weir shape or configuration affects the dimensions of the withdrawal zone and, consequently, the approach velocity. Since weirs do not extend across an entire side of the containment area, flow concentrations of varying degrees occur near the weir, resulting in higher local velocities and possible resuspension of solids. Longer effective weir lengths result in less concentration of flow. The minimum width through which the flow must pass may be termed the effective weir length  $L_e$ .

4.4.5.4 Design procedure. To design a new weir to meet a given effluent suspended solids level, the following procedure should be used:

a. Select the appropriate operating line in the lower portion of the nomograph based on the governing settling behavior of the dredged material slurry (zone or flocculant).

b. Construct horizontal lines at the design inflow rate  $Q_i$  and the ponding depth expected at the weir as shown in the key in Figure 4-18. This ponding depth may be larger than the average ponding depth for large containment areas as the result of a slope taken by the settling material. The ponding depth at the weir may be estimated by using the following equation:

$$H_{pd(weir)} = H_{pd} + 1/2 Lps(0.001) \quad (4-1)$$

where

$H_{pd(weir)}$  = estimated ponding depth at the weir, ft

$H_{pd}$  = average ponding depth, ft

$Lps$  = length of ponded surface between inflow point and weir, ft

c. Construct a vertical line from the point of intersection of the horizontal ponding depth line and the selected operating line of the nomograph. The required effective weir length is found at the intersection of the vertical line and the horizontal design flow line. An example is shown in the key in Figure 4-17.



d. Determine the number of weir structures, the physical dimensions of each, and the locations, based on the weir type to be used and the configuration of the containment area. If a satisfactory balance between effective weir length and ponding depth cannot be achieved, intermittent operation or use of a smaller dredge may be required to prevent resuspension at the weir as the containment area is filled. An illustrative problem is given in Appendix I, "Design Calculations for Retention of Solids and Initial Storage."

#### 4.4.5.5 Effect of weir type.

a. Rectangular weirs. Rectangular weirs, the most commonly used weir type, may consist of rectangular wood- or metal-framed inlets or half-cylindrical corrugated metal pipe risers. Examples are shown in Figures 4-19 and 4-20. The effective weir length is equal to the actual weir crest length for rectangular weirs, as illustrated in Figure 4-21a.

b. Jutting weirs. A modified form of the rectangular weir is the jutting weir (Figure 4-21b). It is possible to achieve a greater effective weir length using a jutting weir since the effective length  $L_e$  equals  $L + 2J$ , as shown in Figure 4-21b.

c. Polygonal (labyrinth) weirs. Polygonal (labyrinth) weirs have been used to reduce the depth of flow over the weir. However, use of such weirs has little impact on effluent suspended solids concentrations since the controlling factor for the depth of withdrawal is usually not the flow over the weir but the approach velocity. Therefore, the approach velocity and the withdrawal depth for the rectangular weir in Figure 4-21a would be the same as that for the polygonal weir in Figure 4-21c since both weirs have the same effective length  $L_e$ , even though the total weir crest length for the polygonal weir is considerably greater. Use of polygonal weirs is not recommended because of the greater cost and the marginal improvement of effluent quality realized when using such a weir.

d. Shaft-type weirs. In some cases, the outflow structure is a four-sided drop inlet or shaft located within the containment area as shown in Figure 4-21d. In evaluating the effective weir length for shaft-type weirs, the approach velocity is a key consideration. To minimize the approach velocity and, therefore, the withdrawal depth, the shaft weir should not be placed too near the dike. In Figure 4-21d, location A is the most desirable since flow can approach from all sides (four effective sides). Location B is less desirable since flow can approach from only three directions (three effective sides), and Location C is the least desirable since it has only two effective sides. Because effluent pipes must run from the shaft weir under the dike to the receiving stream, a location such as A in Figure 4-21d may not be optimal since it is far from the dike and requires a longer pipe than location B.

e. Telescoping weir. The Norfolk District has developed a new circular telescoping weir designed to allow for precise control of the weir crest elevation. The weir can be adjusted remotely by electric motor. A photo of the telescoping weir now in use at Craney Island in the Norfolk District is shown in Figure 4-22.



Figure 4-19. Rectangular Weir (1)



Figure 4-20. Rectangular Weir (2)

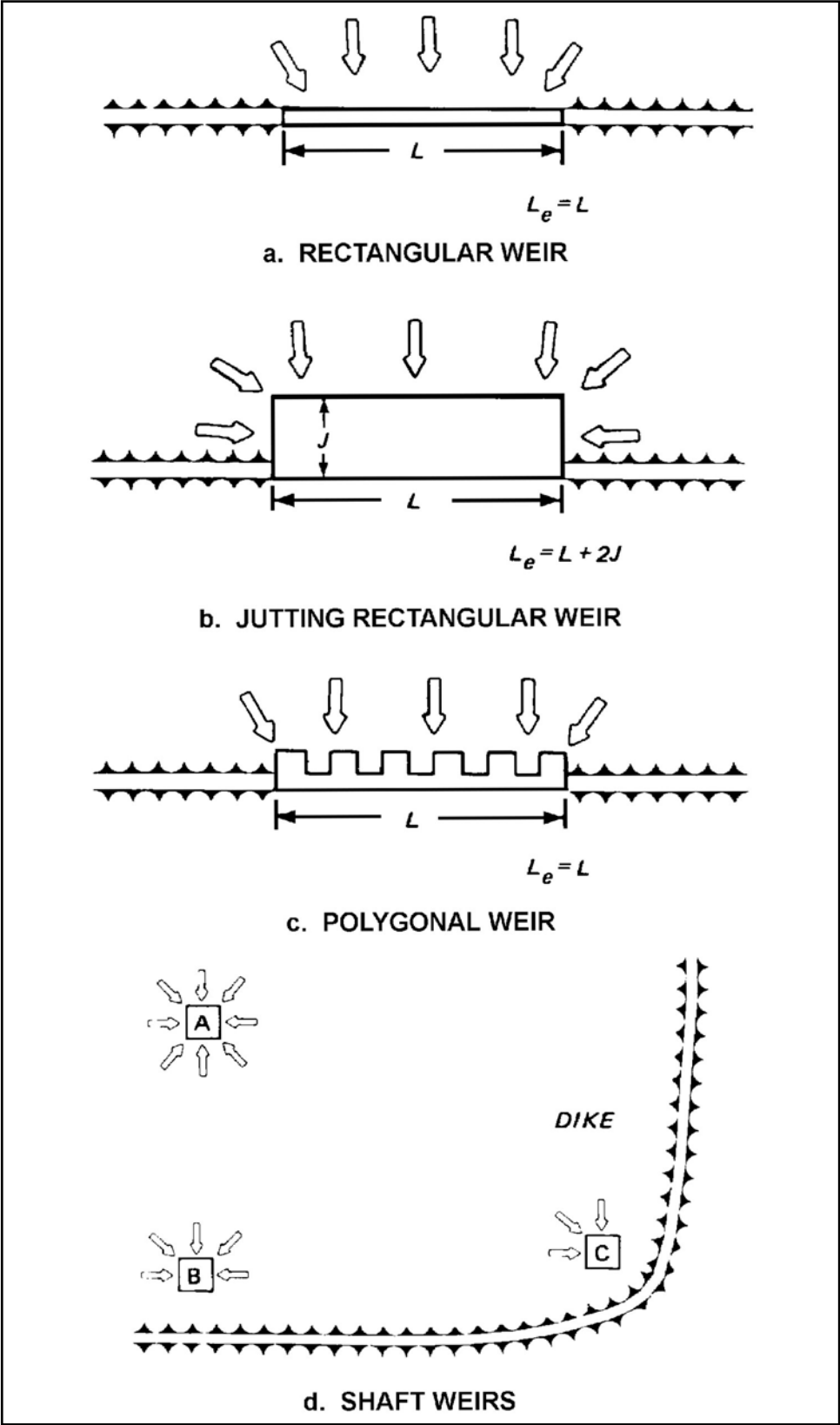

Figure 4-21. Effective Lengths of Various Weir Types



a. Telescoping Weir



b. Closeup of Adjustable Weir

Figure 4-22. Telescoping Weir at Craney Island

f. Converting weir length. To convert the weir length determined from the design nomographs to length  $L_s$  of a side of the square shaft weir, use the following formula:

$$L_s = \frac{L_e}{n} \quad (4-2)$$

where  $n$  is the number of effective sides of a shaft-type weir. A side is considered effective if it is at least 1.5  $L_s$  ft away from the nearest dike, mounded area, or other dead zone. This distance is generally accepted as being sufficient to prevent the flow restriction caused by the flow contraction and bending due to the walls.

g. Structural design. Weirs should be structurally designed to withstand anticipated loadings at maximum ponding elevations. Considerations should be given to uplift forces, potential settlement, access, corrosion protection, and potential piping beneath or around the weir. Additional information regarding structural design of weirs is found in Hammer and Blackburn (1977). Outlet pipes for the weir structure must be designed to carry flows in excess of the flow rate for the largest dredge size expected. Larger flow capacity of the outlet pipes may be needed if an emergency release of ponded water is required.

#### 4.5 Design and Management for Long-Term Storage Capacity.

##### 4.5.1 General.

4.5.1.1 Many dredging projects are located where there are excessive and often conflicting land use demands. Therefore, CDFs for dredged material must be efficiently utilized. Furthermore, the demand for long-term management strategies to meet dredging requirements over the life of navigation projects continues to grow. Such strategies require the estimation of long-term storage capacities of CDFs for known or estimated volumes of sediment to be dredged at varying locations and times over a period of many years. Complete strategies also include plans for managing CDFs to dewater the dredged material and increase storage capacity.

4.5.1.2 Guidance for management of CDFs for long-term storage capacity was initially developed in the 1970s (Haliburton 1978) and later refined based on District field experience (Palermo 1992). This chapter describes procedures for estimating long-term storage capacity of CDFs, conducting appropriate testing programs for these evaluations, and managing CDFs to increase storage capacity.

4.5.1.3 The storage capacity is defined as the total volume available to hold additional dredged material and is equal to the total unoccupied volume minus the volume associated with ponding requirements and freeboard requirements. The total volume available is limited by the surface area of the site and the ultimate height to which dikes can be constructed. If the CDF is intended for one-time use, initial storage capacity and retention of solids during filling are the only design considerations (paragraph 4.4). However, if the CDF is intended for long-term use, the long-term storage capacity must also be considered. The estimation of long-term storage capacity is an important consideration for long-term planning and design of new containment areas or evaluation of the remaining service life of existing sites.



#### 4.5.2 Factors affecting long-term storage capacity.

4.5.2.1 As dredged material is placed in the CDF, the fill height increases. Following the completion of a filling cycle, the fill height decreases due to three processes: sedimentation, consolidation, and desiccation. Sedimentation is a relatively short-term process, and the settling properties of the material determine the requirements for ponding and initial storage during filling (paragraph 4.4). Consolidation and desiccation are long-term processes that determine the long-term storage capacity requirements.

4.5.2.2 The coarse-grained fraction of dredged material (sands and coarser material) undergoes sedimentation quickly and will occupy essentially the same volume as occupied prior to dredging. However, the fine-grained fraction of the material (silts and clays) requires longer settling times, initially occupy considerably more volume than prior to dredging, and will undergo a considerable degree of long-term volume change due to consolidation if hydraulically placed. Such materials are essentially under-consolidated soils, and the consolidation takes place due to self-weight loading.

4.5.2.3 Dredged material placement also imposes a loading on the containment area foundation, and additional settlement may result from consolidation of compressible foundation soils. Settlement due to consolidation is, therefore, a major factor in the estimation of long-term storage capacity. Since the consolidation process for fine-grained materials is slow, total settlement may not have taken place before the containment area is required for additional placement of dredged material. Settlement of the containing dikes may also significantly affect the available storage capacity and should be carefully considered.

4.5.2.4 Once a given active dredging operation ends, the ponded surface water required for settling is decanted, exposing the dredged material surface to desiccation (evaporative drying). This process, which is both time-dependent and climate-dependent, can further add to long-term storage capacity. Active dewatering operations, such as surface trenching, can speed the natural dewatering process. A conceptual diagram illustrating these processes is shown in Figure 4-23.

4.5.2.5 Methods are readily available to predict the capacity gains possible through consolidation and desiccation. The following data are required to estimate long-term storage capacity:

- a. Physical properties of the sediments and foundation soils, such as specific gravity, grain size distributions, Atterberg liquid and plastic limits, and water contents.
- b. Consolidation properties of the fine-grained dredged material and foundation soils (relationships of void ratio and permeability versus effective stress).
- c. CDF site characteristics, such as surface area, ultimate dike height, groundwater table elevations, average pan evaporation rates, and average rainfall.
- d. Dredging data, such as volumes to be dredged, rate of filling, and frequency of dredging (Poindexter-Rollings 1989).

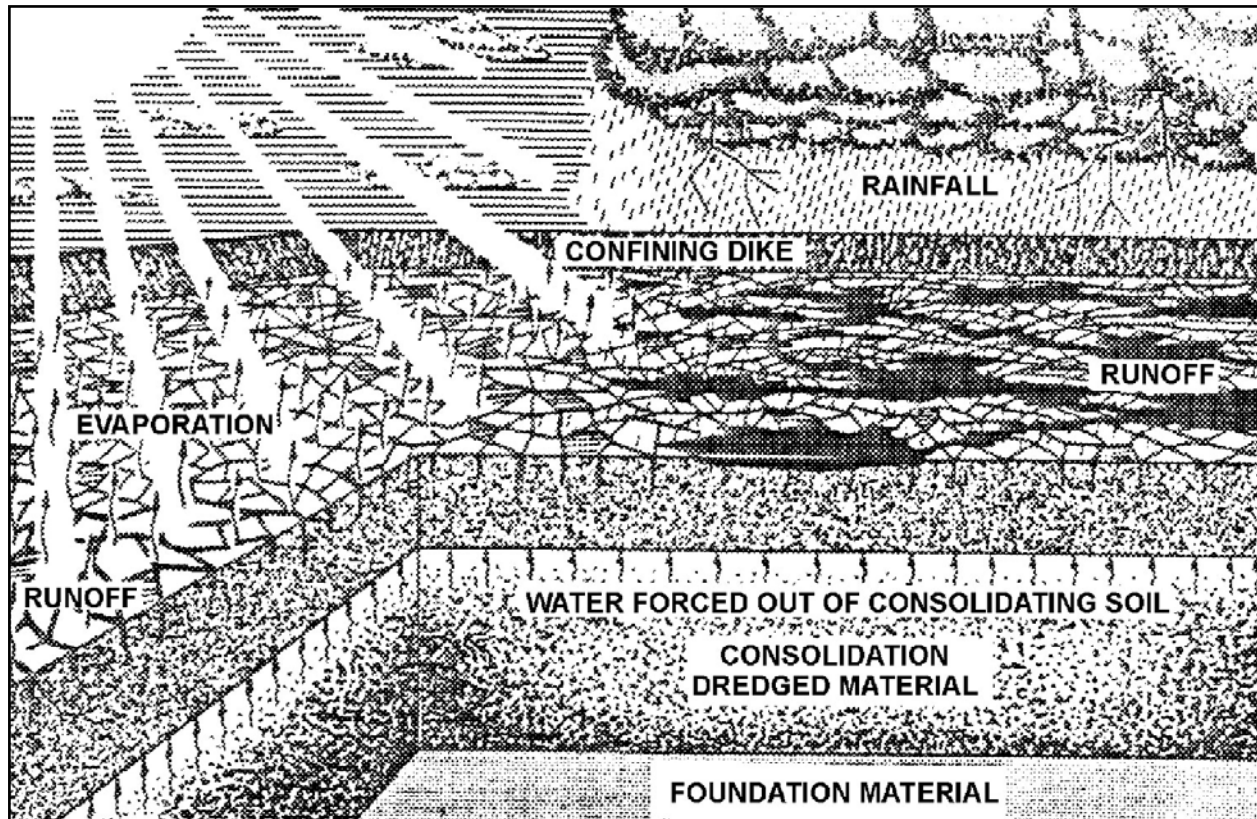

Figure 4-23. Conceptual Diagram of Dredged Material Consolidation and Dewatering Processes

4.5.2.6 Guidelines for estimation of gains in long-term capacity due to settlement within the containment area are based on the fundamental principles of consolidation theory modified to consider the self-weight consolidation behavior of newly placed dredged material. The guidelines are presented in the following paragraphs; illustrative examples are found in Appendix L, “Estimation of Dredged Material Consolidation by Finite Strain Technique.”

a. Dredged material consolidation. Three types of consolidation may occur in dredged material containment areas: primary consolidation, secondary consolidation, and consolidation resulting from desiccation. An additional process influencing settlement is consolidation in underlying material.

(1) Primary consolidation. The Terzaghi standard theory of one-dimensional consolidation, or “small strain theory,” has received widespread use among geotechnical engineers and continues to be the first choice for estimation of settlements. It has been used for consolidation problems in which the magnitude of settlement is small in comparison to the thickness of the consolidating layer. In contrast to the small strain theory, a “finite strain theory” for one-dimensional consolidation is better suited for describing the large settlements common to the primary consolidation of soft fine-grained dredged material. Calculation techniques are discussed in paragraph 5-2.

(2) Secondary consolidation. The process of secondary consolidation or “creep” refers to the rearrangement of soil grains under load following completion of primary consolidation. Usually, this process is not considered in settlement analyses and is not considered in this manual.

(3) Desiccation consolidation. There are basically two phenomena that control the amount of consolidation caused by desiccation of fine-grained dredged material. The first is the evaporation of water from the upper sections of the dredged material. The resulting reduction in its moisture content causes a reduction in void ratio or volume occupied due to the negative pore water pressure induced by the drying. This can be referred to as the dewatering process and is discussed in paragraph 4.5.6.2.

(4) Consolidation in underlying material. An additional process influencing settlement involves the primary consolidation in underlying material when the free water surface is lowered. As the water surface moves downward, the unit weight acting on lower material changes from buoyant unit weight to effective unit weight. The material below the new water level is, therefore, subjected to an additional surcharge.

b. Dredged material dewatering processes.

(1) If the CDF is well managed following active filling, the excess water will be drained from the surface, and natural evaporation will act to dewater the material. However, active dewatering operations should be considered to speed up the dewatering process and achieve the maximum possible volume reduction, considering the site-specific conditions and operational constraints.

(2) Once a given active filling operation ends, any ponded surface water required for settling should be decanted, exposing the dredged material surface to desiccation (evaporative drying). This process can further add to long-term storage capacity and is a time- and climate-dependent process. However, active dewatering operations, such as surface trenching, enhances the natural dewatering process.

c. General process description.

(1) Desiccation of dredged material is basically removal of water by evaporation and transpiration. In this report, plant transpiration is considered insignificant due to the recurrent deposition of dredged fill and is, therefore, disregarded. Evaporation is mainly controlled by such variables as radiation heating from the sun, convective heating from the earth, air temperature, ground temperature, relative humidity, and wind speed.

(2) However, other factors must also be taken into account. For instance, the evaporation efficiency is normally not a constant, but some function of depth to which the layer has been desiccated. It also depends on the amount of water available for evaporation.

(3) It is practical to make desiccation calculations on a monthly basis because of the availability of long-term monthly average rainfall and pan evaporation data, which have been tabulated and published in climatic summaries by the U.S. Weather Bureau for many areas of the United States. Tables and maps of average monthly rainfall and pan evaporation rates for select



stations are available from the National Oceanic and Atmospheric Administration (NOAA). In the absence of more site-specific data, these sources can be used for specification of climatic data.

d. Evaporative stages. Evaporative drying of dredged material leading to the formation of a desiccated crust is a two-stage process. The removal of water occurs at differing rates during the two stages, as shown in Figure 4-24.

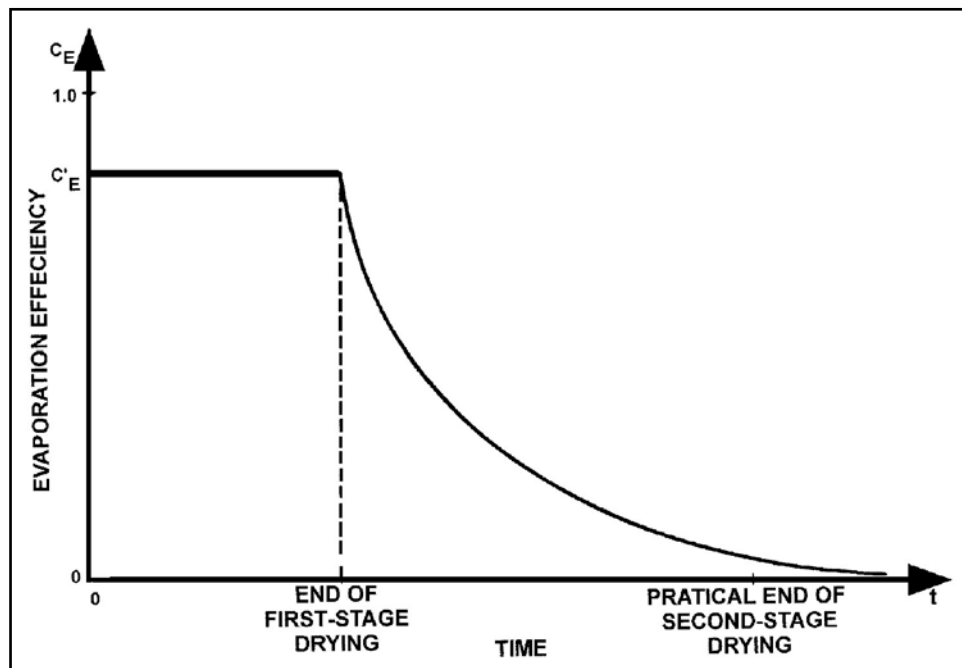

Figure 4-24. Dredged Material Evaporative Efficiency as a Function of Time

(1) The first stage begins when all free water has been decanted or drained from the dredged material surface. The void ratio at this point  $e_{oo}$  corresponds to zero-effective stress as determined by laboratory sedimentation and consolidation testing. This initial void ratio has been empirically determined to be at a water content of approximately 2.5 times the Atterberg liquid limit (LL) of the material. First-stage drying ends and second stage begins at a void ratio that may be called the decant point or saturation limit  $e_{SL}$ . The  $e_{SL}$  of typical dredged material has been empirically determined to be at a water content of approximately 1.8 LL.

(2) Second-stage drying is an effective process until the material reaches a void ratio that may be called the desiccation limit or  $e_{DL}$ . When the  $e_{DL}$  reaches a limiting depth, evaporation of additional water from the dredged material effectively ceases. Any additional evaporation is limited to excess moisture from undrained rainfall and the water forced out of the material as a result of consolidation of material below the crust. The  $e_{DL}$  of typical dredged material may roughly correspond to a water content of 1.2 plastic limit (PL). Also associated with the  $e_{DL}$  of a material is a particular percentage of saturation that probably varies from 100% to something slightly less, depending on the material.

#### 4.5.3 Estimation of long-term storage capacity.

4.5.3.1 Data requirements. The data required to estimate long-term storage capacity include physical properties of the sediments and foundation soils such as specific gravity, grain size distributions, Atterberg liquid and plastic limits, and water contents; the consolidation properties of the fine-grained dredged material and foundation soils (relationships of void ratio and permeability versus effective stress); CDF site characteristics, such as surface area, ultimate dike height, groundwater table elevations, average pan evaporation rates, and average rainfall; and dredging data, such as volumes to be dredged, rate of filling, and frequency of dredging (Poindexter-Rollings 1989).

4.5.3.2 Consolidation testing. Consolidation tests for foundation soils should be performed using conventional procedures (EM 1110-2-1906). However, specialized procedures are necessary for consolidation testing of sediment samples because of their fluidlike consistency. Specially developed self-weight consolidation tests (Cargill 1986) can be used to determine consolidation characteristics at low effective stresses. Controlled-rate-of-strain tests (Cargill 1986) or fixed-ring consolidometers should be used to determine characteristics at higher effective stresses. Modifications in sample preparation and the method of loading are necessary for the conventional fixed-ring procedure when testing sediments. Detailed procedures for conducting consolidation tests are presented in Appendix J, "Dredged Material Consolidation Test Procedures."

#### 4.5.3.3 Storage capacity/time relationship.

a. The estimated time-settlements due to dredged material consolidation and dewatering as well as foundation consolidation may be combined to yield a total settlement relationship for a single lift, as shown in Figure 4-25. These data are sufficient for estimation of the remaining capacity in the short term. However, if the containment area is to be used for long-term placement of subsequent lifts, a projected plot of dredged material surface height versus time should be developed. This plot can be developed using time-settlement relationships for sequential lifts combined, as shown in Figure 4-26. Such data may be used for preliminary estimates of the long-term service life of the containment area.

b. The maximum dike height, as determined by foundation conditions or other constraints, and the containment surface area dictate the maximum available storage volume. The increases in dredged material surface height during the dredging phases and the decreases during settlement phases correspond to respective decreases and increases in remaining containment storage capacity, as shown in Figure 4-27. Projecting the relationships for surface height or for remaining capacity to the point of maximum allowable height or exhaustion of remaining capacity, respectively, will yield an estimate of the containment area service life. Gains in capacity due to anticipated dewatering or material removal should also be considered in making the projections.

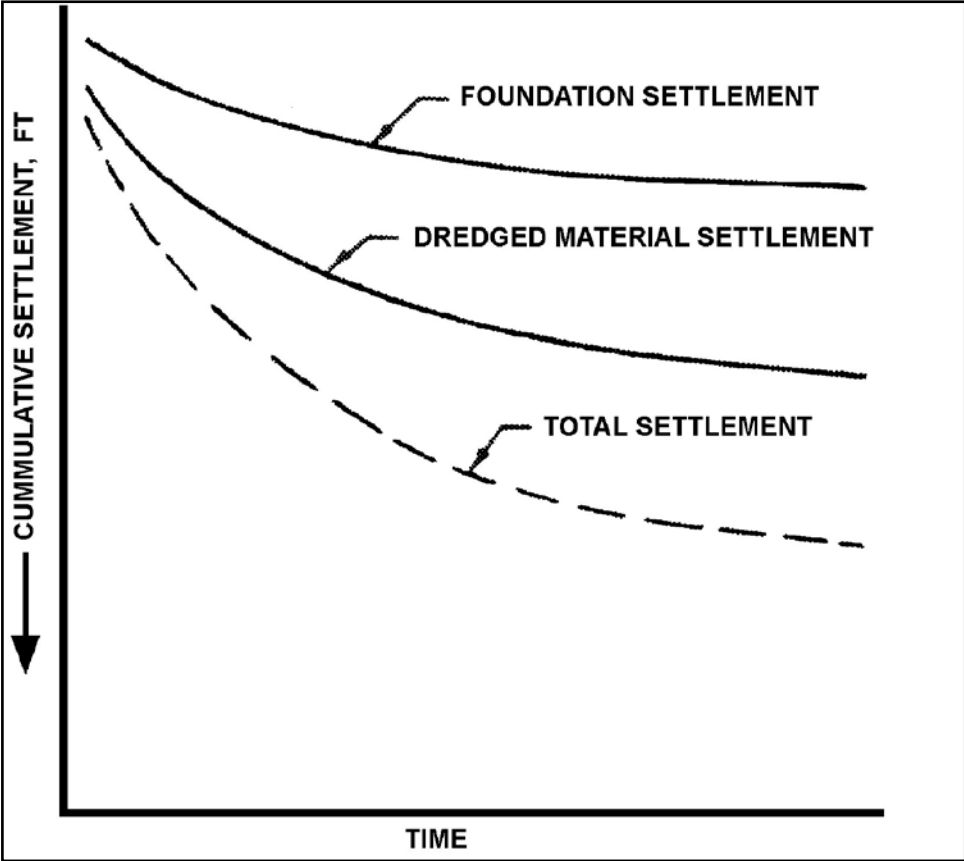

Figure 4-25. Illustrative Time-Consolidation Relationships

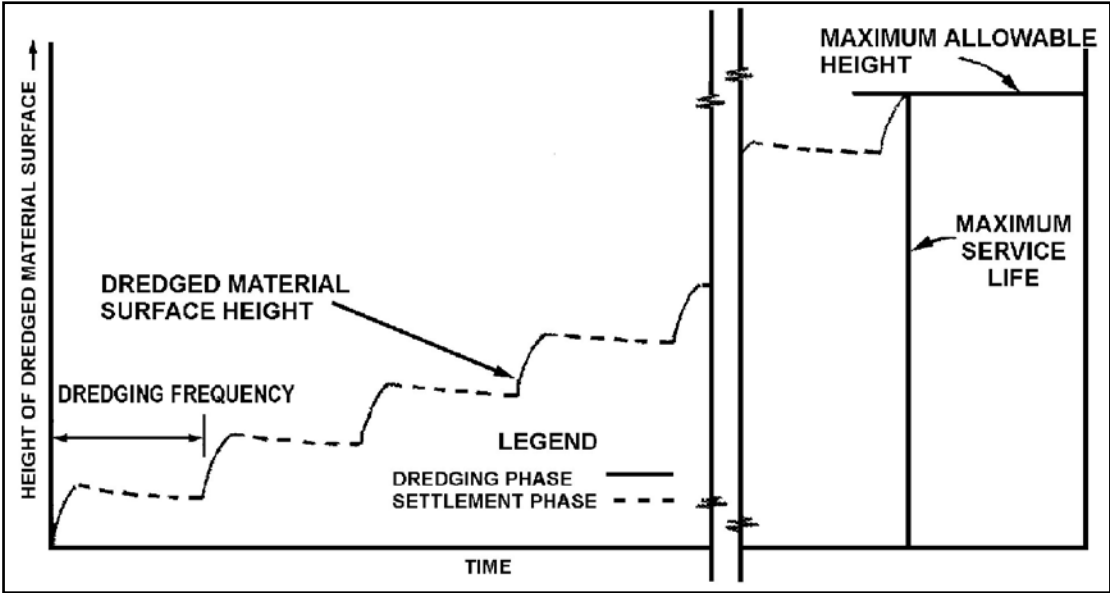

Figure 4-26. Projected Surface Height for Determination of Containment Area Service Life

31 Jul 15

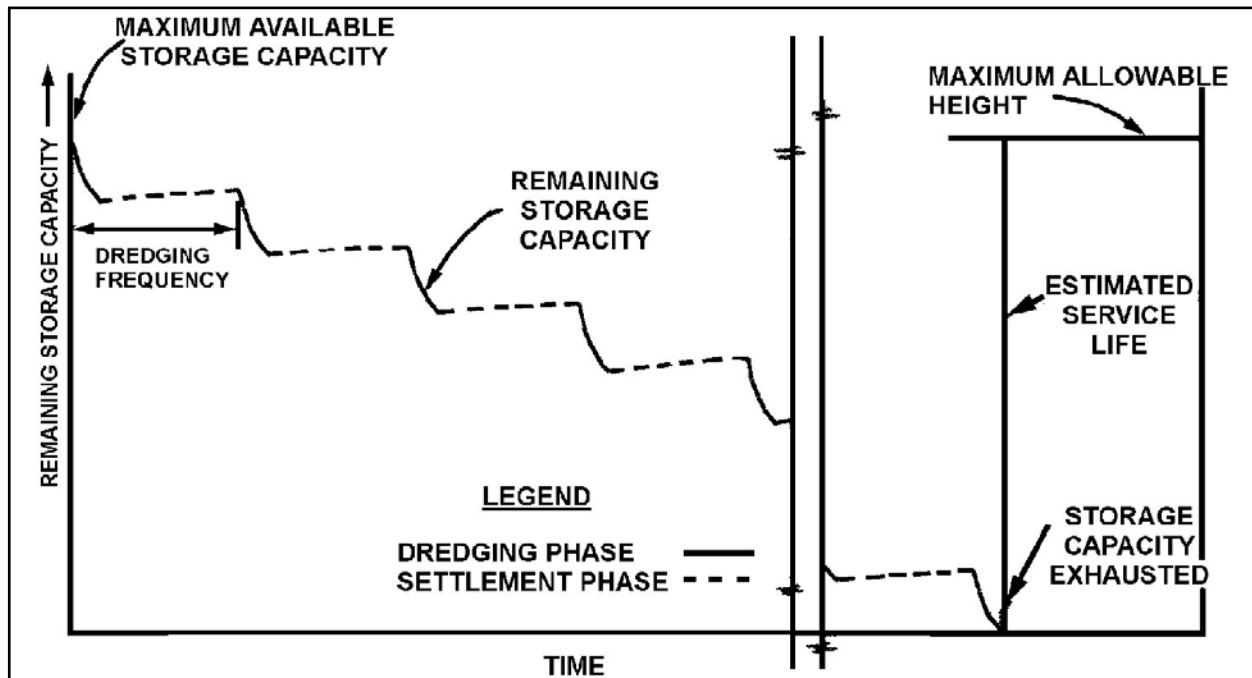

Figure 4-27. Projected Storage Capacity for Determination of Containment Area Service Life

c. The complex nature of the consolidation and desiccation relationships for multiple lifts of compressible dredged material and the changing nature of the resulting loads imposed on compressible foundation soils may result in errors in projections of remaining storage capacity over long time periods. Accuracy can be greatly improved by updating the estimates every few years using data from newly collected samples and laboratory tests. Observed field behavior should also be routinely recorded and used to refine the projections.

#### 4.5.3.4 Overview of estimation techniques.

##### a. Small strain versus finite strain consolidation.

(1) The most applicable procedure for estimating consolidation in soft dredged material is the finite strain consolidation theory. The magnitude of consolidation, as determined by small strain techniques, is equivalent to that determined by the finite strain technique. However, the time rate of consolidation is overly conservative for small strain in that the rate of consolidation as predicted is slow when compared to field behavior (Cargill 1983, 1985). Details on the theoretical background for the finite strain theory are given in Cargill (1983, 1985).

(2) The advantages of using the finite strain technique for the estimation of dredged material consolidation settlement are summarized in Table 4-2. The technique accounts for the nonlinearity of the void ratio, permeability, and coefficient of consolidation relationships that must be considered when large settlements of a layer are involved. Hand calculations using the finite strain approach have been developed and are presented in this manual. However, the technique is more easily applied using a computer program.

Table 4-2. Comparison of Small Strain and Finite Strain Consolidation Techniques

Consideration	Small Strain	Finite Strain
Range of void ratios	Very small	Very large
Self-weight	Not included	Included
Void ratio/effective stress relationship	Linear	Nonlinear
Void ratio/permeability relationship	Constant	Variable

b. Empirical methods for estimating desiccation behavior. Empirical equations for estimating the settlement of a dredged material layer due to desiccation and the thickness of dried crust were developed for the purpose of determining feasibility and benefits of active dewatering operations (Haliburton 1978). The empirical relationships have been refined (Cargill 1986) to consider the two-stage process of desiccation and the overall water balance relationships that exist within a dredged material placement area. The interaction of the desiccation process with dredged material consolidation due to self-weight has been incorporated in computer programs for estimating long-term storage capacity. The refined empirical relationships can be easily applied in determining the benefits of dewatering programs and provide increased accuracy in storage capacity evaluations.

c. Hand calculation versus computer solution.

(1) The use of computer models can greatly facilitate the estimation of storage capacity for containment areas. Although the computations for simple cases can be easily and quickly done by hand, the analyses often require computations for a multi-year service life with variable placement operations and possibly material removal or dewatering operations occurring intermittently throughout the service life. These complex computations can be done more efficiently using a computer model.

(2) The use of computer models holds an added advantage when considering the additional settlements that occur as the result of dredged material desiccation (dewatering). While the estimation of desiccation behavior can be done by hand calculation, the interaction between desiccation and consolidation cannot because it requires cumbersome iterative calculations. A computer program is well suited to handle the calculations of both consolidation and desiccation as well as the interaction between the two processes.

(3) Methods of hand calculation for finite strain consolidation and desiccation are presented in Appendix L, "Estimation of Dredged Material Consolidation by Finite Strain Technique." These calculations are manageable for estimation of settlements in one dredged material layer. However, if storage capacity estimates must be made for multiple placement operations, the use of computer programs is recommended.

4.5.3.5 Computer solutions for consolidation and desiccation.

a. The theory of finite strain consolidation (Gibson, England, and Hussey 1967) has been incorporated into several generations of computer models for analyzing consolidation of capped sediment mounds (Cargill 1985; Poindexter-Rollings 1990; Stark 1995). To run any of these

models, consolidation test data from self-weight consolidation tests and/or standard oedometer tests (EM 1110-2-1906) are required (Appendix K, “Jar Test Procedures for Chemical Clarification”).

b. Initial work on consolidation of dredged material was done with the computer model PCDDF (Primary Consolidation and Desiccation of Dredged Fill) (Cargill 1985), which was later modified and released as PCDDF89 (Stark 1991); these programs were developed specifically for analysis of CDFs. Most recently, PCDDF89 has been updated to include secondary compression; this version is known as PSDDF (Primary Consolidation, Secondary Compression, and Desiccation of Dredged Fill). Each of these computer programs is based on the same one-dimensional theory of consolidation and is capable of predicting the consolidation of multiple compressible layers. Computational details and processing speeds vary among the programs, but similar consolidation estimates should be obtained from each.

c. PCDDF is available as a part of the ADDAMS system (Appendix F, “Automated Dredging and Disposal Alternatives Modeling System [ADDAMS]”). Theoretical documentation, descriptions of solution techniques, and a user guide are available (Cargill 1985; Poindexter-Rollings and Stark 1989; Stark 1991).

d. Examples of the results obtained using the PCDDF model are shown in Figures 4-28 and 4-29. These figures show plots of dredged material surface elevation versus time for several cases including multiple layers deposited at varying times. Field data collected at the respective sites are also shown for comparison.

#### 4.5.4 Dredged material dewatering operations.

##### 4.5.4.1 General.

a. If the CDF is well managed following active filling, the excess water will be drained from the surface, and natural evaporation will act to dewater the material. However, active dewatering operations should be considered to speed up the dewatering process and achieve the maximum possible volume reduction, considering the site-specific conditions and operational constraints.

b. A number of dewatering techniques for fine-grained dredged material have been studied (Haliburton 1978; Haliburton et al. 2002). However, surface trenching and the use of underdrains were found to be the only technically feasible and economically justifiable dewatering techniques (Haliburton 1978). Techniques such as vacuum filtration or belt filter presses can be technically effective, but they are not economical for dewatering large volumes of fine-grained material. Guidance for application of underdrains is available (Hammer 1981), and the use of underdrains has been successfully applied in CDFs. However, use of underdrains over large surface areas is not as economical as surface drainage techniques and has not been routinely applied. Accordingly, only techniques recommended for improvement of surface drainage through trenching are described in detail here.

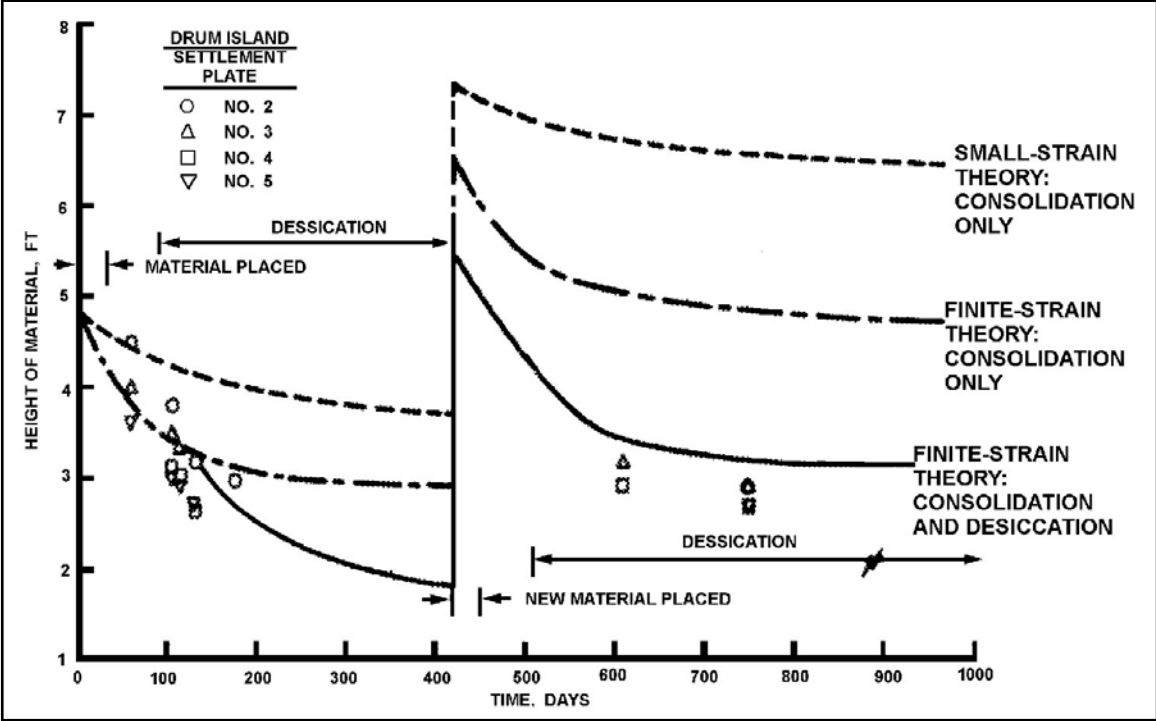

Figure 4-28. Measured and Predicted Material Heights at Drum Island

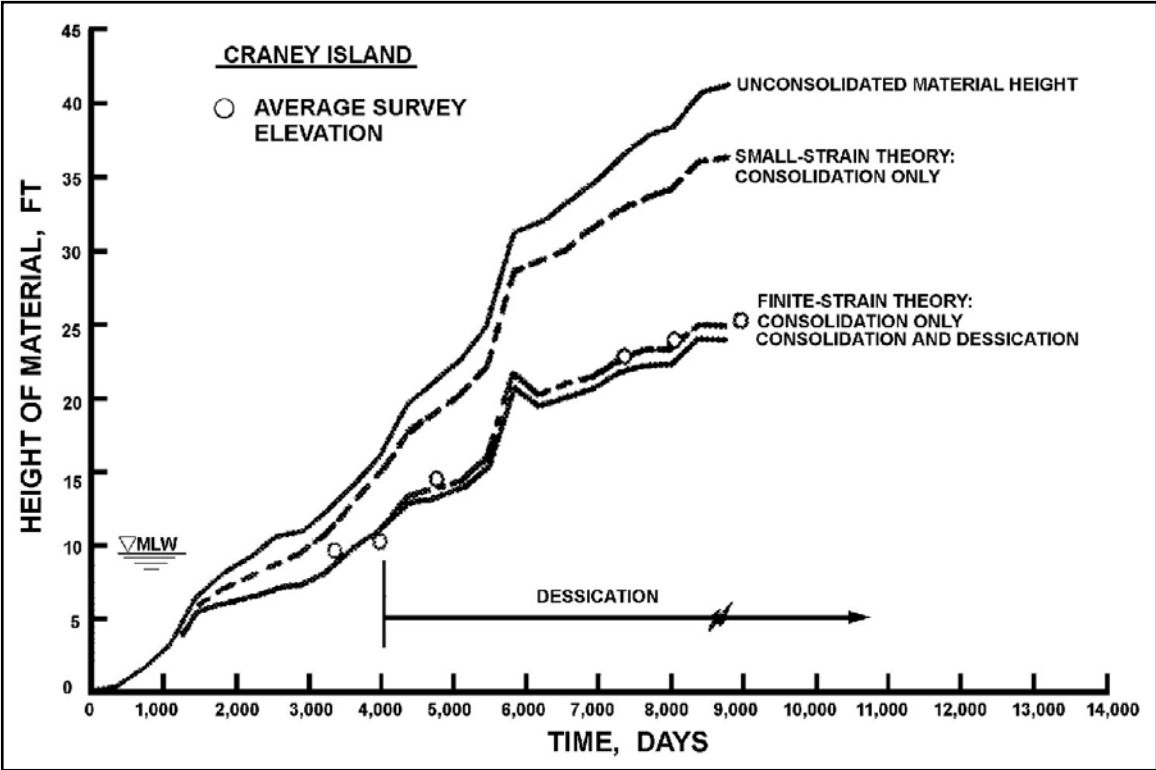

Figure 4-29. Measured and Predicted Material Heights at Craney Island

4.5.4.2 Dewatering by surface trenching. Four major reasons exist for dewatering fine-grained dredged material placed in confined placement areas:

a. Promotion of shrinkage and consolidation, leading to the creation of more volume in the existing placement site for additional dredged material.

b. Reclamation of the dredged material into a more stable soil form for removal and use in dike raising, other engineered construction, or other productive uses, again creating more available volume in the existing placement site.

c. Creation of stable fast land at a known final elevation and with predictable geotechnical properties.

d. Benefits for control of mosquito breeding.

4.5.4.3 Conceptual basis for dewatering by progressive trenching. The following mechanisms were found to control evaporative dewatering of fine-grained dredged material placed in confined placement areas:

a. Establishment of good surface drainage allows evaporative forces to dry the dredged material from the surface downward, even at placement area locations where precipitation exceeds evaporation (negative net evaporation).

b. The most practical mechanism for precipitation removal is by runoff through crust desiccation cracks to surface drainage trenches and off the site through outlet weirs.

c. To maintain effective drainage, the flow-line elevation of any surface drainage trench must always be lower than the base of crust desiccation cracks; otherwise, ponding occurs in the cracks. As drying occurs, the cracks become progressively deeper.

d. Below the desiccation crust, the fine-grained subcrust material may be expected to exist at water contents at or above the liquid limit. Thus, it is difficult to physically construct trenches much deeper than the bottom of the adjacent desiccation crust.

e. To promote continuing surface drainage as drying occurs, it is necessary to progressively deepen site drainage trenches as the water table falls and the surface crust becomes thicker; thus, the name “progressive trenching” was developed for the concept.

f. During conduct of a progressive trenching program, the elevation difference between the internal water table and the flow line of any drainage trench is relatively small. When the relatively low permeability of fine-grained dredged material is combined with the small hydraulic gradient likely under these circumstances, it appears doubtful that appreciable water can be drained from the dredged material by gravity seepage. Thus, criteria for trench location and spacing should be based on site topography, so that precipitation is rapidly removed and ponding is prevented, rather than achieving marked drawdown from seepage.



4.5.4.4 Effects of dewatering. The net observable effects of implementing any program of dewatering by improved surface drainage are as follows:

- a. Disappearance of ponded surface water.
- b. Runoff of the majority of precipitation from the site within a few hours.
- c. Gradual drying of the dredged material to a more stable soil form.
- d. Vertical settlement of the surface of the placement area.
- e. Ability to work within the placement area with conventional equipment.

4.5.4.5 Initial dewatering (passive phase).

a. Once the placement operation is completed, dredged material usually undergoes hindered sedimentation and self-weight consolidation (called the decant phase), and water is brought to the surface of the consolidating material at a faster rate than can normally be evaporated. During this phase, it is extremely important that continued drainage of decant water and/or precipitation through outlet weirs be facilitated. Weir flow-line elevations may have to be lowered periodically as the surface of the newly placed dredged material subsides. Guidelines for appropriate placement site operation during this passive dewatering phase, to maximize decant and precipitation water release while maintaining appropriate water quality standards, are described in paragraph 4.10.

b. Once the fine-grained dredged material approaches the decant point water content, or saturation limit as described previously, the rate at which water is brought to the surface gradually drops below the climatic evaporative demand. If precipitation runoff through site outflow weirs is facilitated, a thin drying crust or skin will form on the newly deposited dredged material. The thin skin may be only several hundredths of a foot thick, but its presence may be observed by noting small desiccation cracks that begin to form at 3-6 ft (1- 2 m) intervals, as shown in Figure 4-30, and the surface water content approaches  $1.8 \times LL$ . Once the dredged material has reached this consistency, active dewatering operations may be initiated.

4.5.4.6 Progressive trenching. Three procedures have been found viable to initiate active dredged material dewatering by improved surface drainage once the material has achieved consistency conditions shown in Figure 4-30: periodic perimeter trenching by dragline, with draglines working initially from perimeter dikes and subsequently from berms established inside the perimeter dikes; periodic interior site trenching; or a combination of these two methods. Only the last two procedures will result in total site dewatering at the maximum rates. The first procedure will have, in many instances, an effective interior dewatering rate considerably less than the predicted maximum rate though the exact lower rate would be highly site specific. This section presents information necessary to properly conduct dewatering operations by these procedures.



Figure 4-30. Surface of Fine-Grained Dredged Material at the Earliest Time when Surface Trenching Should be Attempted

a. Perimeter dragline trenching operations.

(1) Construction of trenches around the inside perimeter of confined placement sites has been used for many years to dewater and/or reclaim fine-grained dredged material. In many instances, the purpose of dewatering has been to obtain convenient borrow for use in perimeter dike raising activities. Draglines and backhoes have been found to be adaptable to certain activities because of their relatively long boom length and/or method of operation and control. The perimeter trenching scheme should be planned carefully so as not to interfere with operations necessary for later dewatering or other management activities.

(2) When dragline trenching operations are initiated, the largest size, longest boom length dragline that can be transported efficiently to the placement site and can operate efficiently on top of placement site dikes should be obtained. Operations should begin at an outflow weir location, where the dragline, operating from the perimeter dike, should dig a sump around the weir, extending into the placement area to maximum boom and bucket reach. The very wet excavated material is cast against the interior side of the adjacent perimeter dike. It may be necessary to board up the weir to prevent the very wet dredged material from falling into the weir box during the sump-digging operation. A localized low spot 2.5-5 cm (1 to 2 in.) below the surrounding dredged material can be formed. Once the sump has been completed, the weir boards should be

removed to the level of the dredged material and, if necessary, handwork should be conducted to ensure that any water flowing into the sump depression will exit through the outflow weir.

(3) Once the sump has been completed, the dragline should operate along the perimeter dike, casting its bucket the maximum practicable distance into the placement area, dragging material back in a wide shallow arc to be cast on the inside of the perimeter dike. A wide shallow depression 2.5-5 cm (1 to 2 in.) lower than the surrounding dredged material will be formed. The cast material will stand on only an extremely shallow (1 vertical on 10 horizontal or less) slope. A small dragline should be able to accomplish between 200 and 400 linear feet of trenching per working day.

(4) Dredged material near the ditch edge tends to dry slightly faster than material located farther out in the placement site, with resulting dredged material shrinkage giving a slight elevation gradient from the site interior toward the perimeter trenches, also facilitating drainage (Figure 4-31). In addition, desiccation crack formation is more pronounced near the drainage trenches, facilitating precipitation runoff through the cracks to the perimeter trenches.

(5) Once appreciable desiccation drying has occurred in the dredged material adjacent to the perimeter trench and the material cast on the interior slope of the perimeter dike has dried, the perimeter trenches and weir sumps should be deepened. The exact time between initial and secondary trench deepening will vary according to the engineering properties of the dredged material and existing climatological conditions, ranging from 2-3 weeks during hot, dry summer months up to 8-10 weeks in colder, wetter portions of the year. Inspection of the existing trenches is the most reliable guideline for initiating new trench work since desiccation cracks 2.5-5 cm (1-2 in.) deep should be observed in the bottom of existing trenches before additional trenching is begun.

(6) Depending on the size of the placement area, relative costs of mobilization and demobilization of dragline equipment, and the relative priority and/or need for dewatering, it may prove convenient to employ one or more draglines continuously over an interval of several months to work the site periodically. A second trenching cycle should be started upon completion of an initial cycle, a third cycle upon completion of the second cycle, and so on, as needed.

(7) During the second trenching, wide shallow trenches with a maximum depth of 5-15 cm (2-6 in.) below the surface of adjacent dredged material can be constructed, and sumps can be dug to approximately 20-30 cm (8-12 in.) below surrounding dredged material. These deeper trenches again facilitate more rapid dewatering of dredged material adjacent to their edges, with resulting shrinkage and deeper desiccation cracks providing a still steeper drainage flow gradient from the site interior to the perimeter trenches.



Figure 4-31. Shallow Initial Perimeter Trench Constructed by a Dragline Operating from the Perimeter Dike

(8) After two, or perhaps three, complete periodic perimeter dragline trenching cycles, the next phase of the trenching operation may be initiated. In this phase, the dragline takes the now dry material placed on the interior of the perimeter dike and spreads it to form a low berm adjacent to the dike inside the placement area. The dragline then moves onto this berm—using single or double mats, if required, as well as the increased digging reach now available—and widens and extends the ditch into the placement site interior, as shown in Figure 4-32. The interior side of the ditch is composed of material previously dried, and a ditch 12 to 18 in. deep may be constructed, as shown in Figure 4-33. Material excavated from this trench is again cast on the interior slope of the perimeter dike to dry and be used either for raising the perimeter dike or for subsequent berming farther into the placement area.

(9) After two or more additional periodic trench deepening operations, working from the berm inside the placement area, trenches up to 1-1.5 m (3-5 ft) deep may be completed. Trenches of this depth cause accelerated drying of the dredged material adjacent to the trench and produce desiccation cracks extending almost the entire thickness of the adjacent dredged material, as shown in Figure 4-34. A well-developed perimeter trench network leading to outflow weirs is now possible, as shown in Figure 4-35, and precipitation runoff is facilitated through gradual development of a network of desiccation cracks, which extend from the perimeter trenches to the interior of the site.



Figure 4-32. A Small Dragline on Mats, Working on a Berm, Deepens a Shallow Perimeter Trench



Figure 4-33. Construction of a Ditch 30-45 cm (12 to 18 in.) Deep with Excavated Material Cast on the Interior Slope of a Perimeter Dike

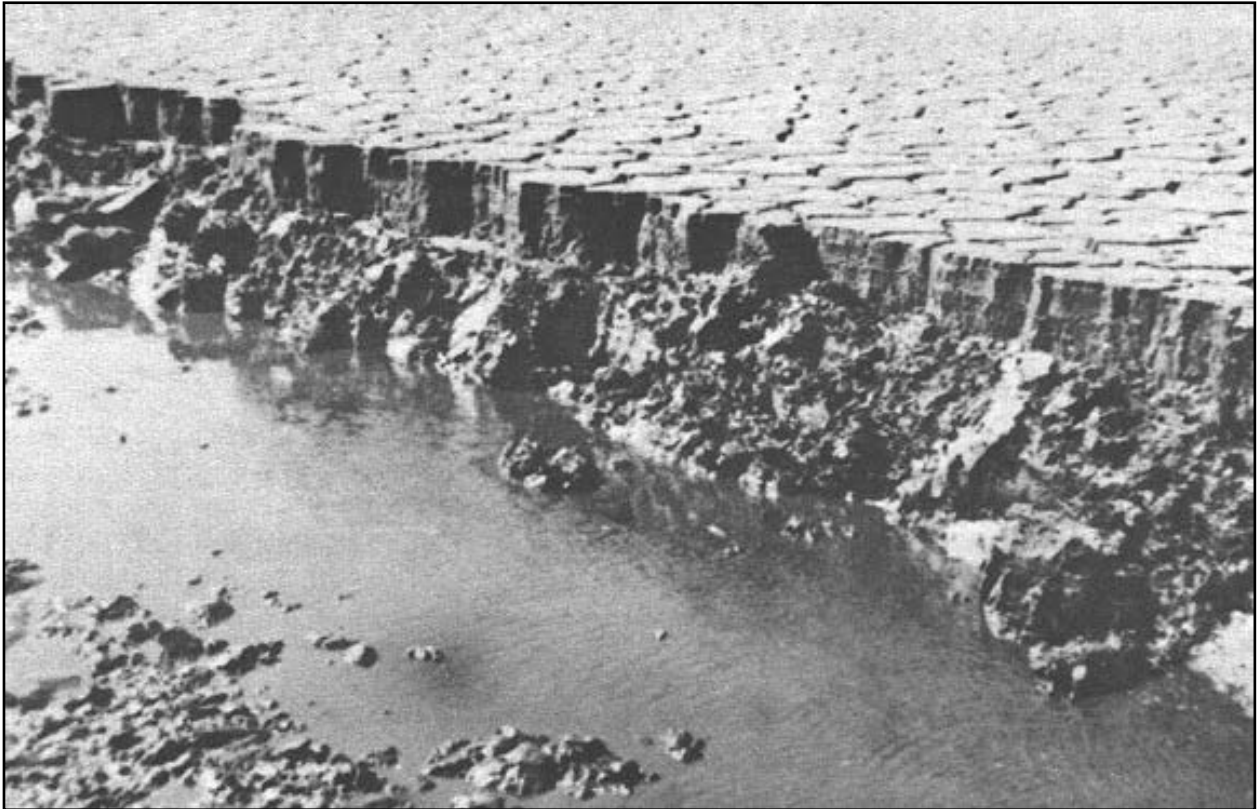

Figure 4-34. Desiccation Crust Adjacent to the Perimeter of a 1-1.5 m (3-5 ft) Deep Drainage Trench

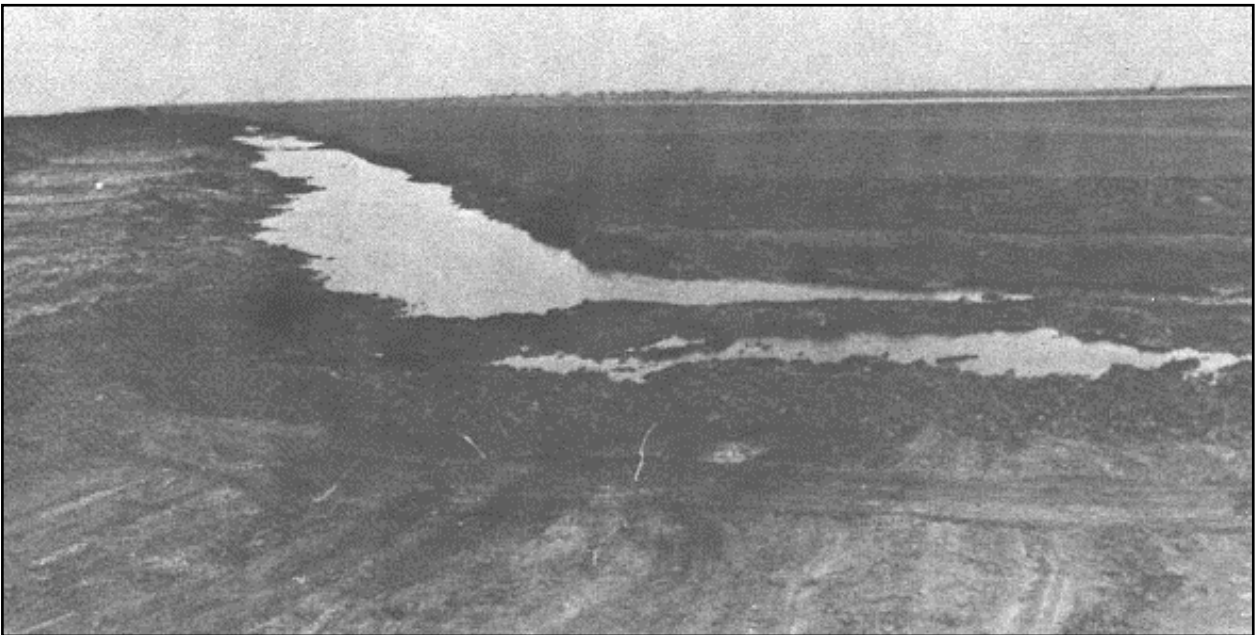

Figure 4-35. A Well-Developed Perimeter Trenching System, Morris Island Placement Site, Charleston District



(10) Once a perimeter trench system, such as that shown in Figure 4-35, is established, progressive deepening operations should be conducted at less frequent intervals, and major activity should be changed from deepening perimeter trenches and weir sumps to that of continued inspection to ensure the ditches and sumps remain open and facilitate free drainage. As a desiccation crack network develops and the cracks become wider and deeper, precipitation runoff rate will be increased, and precipitation ponding in the site interior will be reduced. As such ponding is reduced, more and more evaporative drying will occur, and the desiccation crack network will propagate toward the placement area interior. Figure 4-35 is a view of the 500-acre Morris Island Placement Site of the Charleston District, where a 1 m (3 ft) lift of dredged material was dewatered down to approximately a 0.5 m (1.7 ft) thickness at the perimeter over a 12-month period by an aggressive program, undertaken by the District, of site drainage improvement with dragline perimeter trenching. Figure 4-36 shows the 30 cm (12 in.) desiccation crust achieved at a location approximately 180 m (200 yd) from the placement area perimeter. The dredged material was a CH clay with an LL over 100. However, despite the marked success with perimeter trenching, a close inspection of Figure 4-35 shows that ponded water still exists in the site interior.

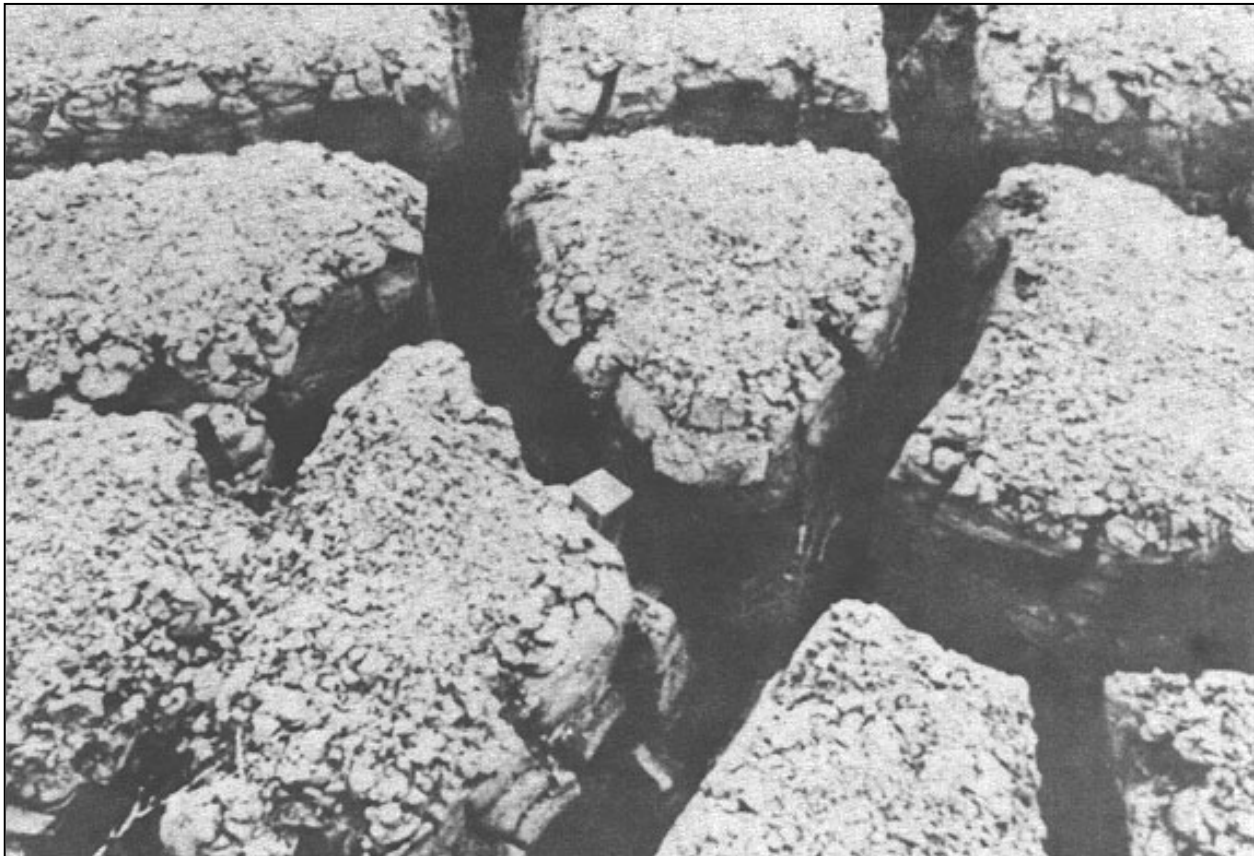

Figure 4-36. Desiccation Crust Achieved in Highly Plastic Clay Dredged Material 180 m (200 yd) into a Placement Area by Perimeter Trenching over a 12-month Period

(11) Interior trenching. As drying continues and perimeter trenching progresses, the construction of interior trenches spaced over the entire surface area of the CDF may be initiated. Only specialized amphibious vehicles (such as those using twin screws for propulsion and flotation)

31 Jul 15

can successfully construct shallow trenches in fine-grained dredged material shortly after formation of a thin surface crust (Palermo 1977; Haliburton 1978). However, field experience has shown that the early stages of evaporative dewatering and crust development occur at acceptable rates considering only the natural drying processes, perhaps aided by perimeter trenching as described previously. Therefore, the use of such specialized trenching equipment is not usually warranted.

b. Rotary trenchers. Once a surface crust of 10-15 cm (4-6 in.) has developed, trenching equipment with continuously operating rotary excavation devices and a low-ground-pressure chassis is recommended for routine dewatering operations. This type of equipment has been used successfully in dewatering operations in the Savannah District and in numerous other locations along the Atlantic Coast for mosquito control. The Charleston, Norfolk, and Philadelphia Districts have also used this equipment for dewatering operations. The major features of the equipment include a mechanical excavation implement with cutting wheel or wheels used to cut a trench up to 0.9 m (3 ft) deep. The low-ground-pressure chassis may be tracked or rubber tired. The major advantage of rotary trenchers is their ability to excavate continuously while slowly moving within the containment area. This allows them to construct trenches in areas where dragline or backhoe equipment would cause mobility problems. Tracked and rubber-tired trenchers are shown in Figures 4-37 and 4-38. The excavating wheels can be arranged in configurations that create hemispherical or trapezoidal trench cross sections and can throw material to one or both sides of the trench. The material is spread in a thin layer by the throwing action, which allows it to dry quickly and prevents the creation of a windrow, which might block drainage to the trench. The excavating devices, ongoing trenching operations, and configuration of constructed trenches are shown in Figures 4-39 through 4-44. Based on past experience, an initial crust thickness of 10-15 cm (4-6 in.) is required for effective mobility of the equipment. This crust thickness can be easily formed within the first year of dewatering effort if surface water is effectively drained from the area, assisted by perimeter trenches constructed by draglines operating from the dikes. A suggested scheme for perimeter and interior trenching using a combination of draglines and a rotary trencher or other suitable equipment is shown in Figure 4-45. The Mobile District has successfully used a "backhoe marshbuggie" for trenching and placing material to raise dikes. This equipment consists of a backhoe excavator mounted on a low-ground-pressure chassis similar to the one shown in Figure 4-38.

c. Trench spacing. The minimum number of trenches necessary to prevent precipitation ponding on the placement area surface should be constructed. These trenches should extend directly to low spots containing ponded water. However, the greater the number of trenches per unit of placement site area, the shorter the distance that precipitation runoff will have to drain through desiccation cracks before encountering a drainage trench. Thus, closely spaced trenches should produce more rapid precipitation runoff and may slightly increase the rate of evaporative dewatering. Conversely, the greater the number of trenches constructed per unit of placement site area, the greater the cost of dewatering operations and the greater their impact on subsequent dike raising or other borrowing operations. However, the rotary trenchers have a relatively high operational speed, and it is, therefore, recommended that the maximum number of drainage trenches be placed consistent with the specific trenching plan selected. Trench spacings of 30-60 m (100 to 200 ft) have normally been used. If topographic data are available for the disposal site interior, they may be used as the basis for preliminary planning of the trenching plan.





Figure 4-37. Rubber-Tired Rotary Trencher



Figure 4-38. Track-Mounted Rotary Trencher Used in Mosquito-Control Activities



Figure 4-39. Hemispherical Rotary Trenching Implement



Figure 4-40. Trapezoidal Rotary Trenching Implement



Figure 4-41. Rotary Trenching Device in Operation



Figure 4-42. General View of Trenches Formed by a Rotary Trencher





Figure 4-43. Close-Up View of Trenches Formed by a Rotary Trencher



Figure 4-44. General View of a Confined Disposal Area Showing Parallel Trenches in Place

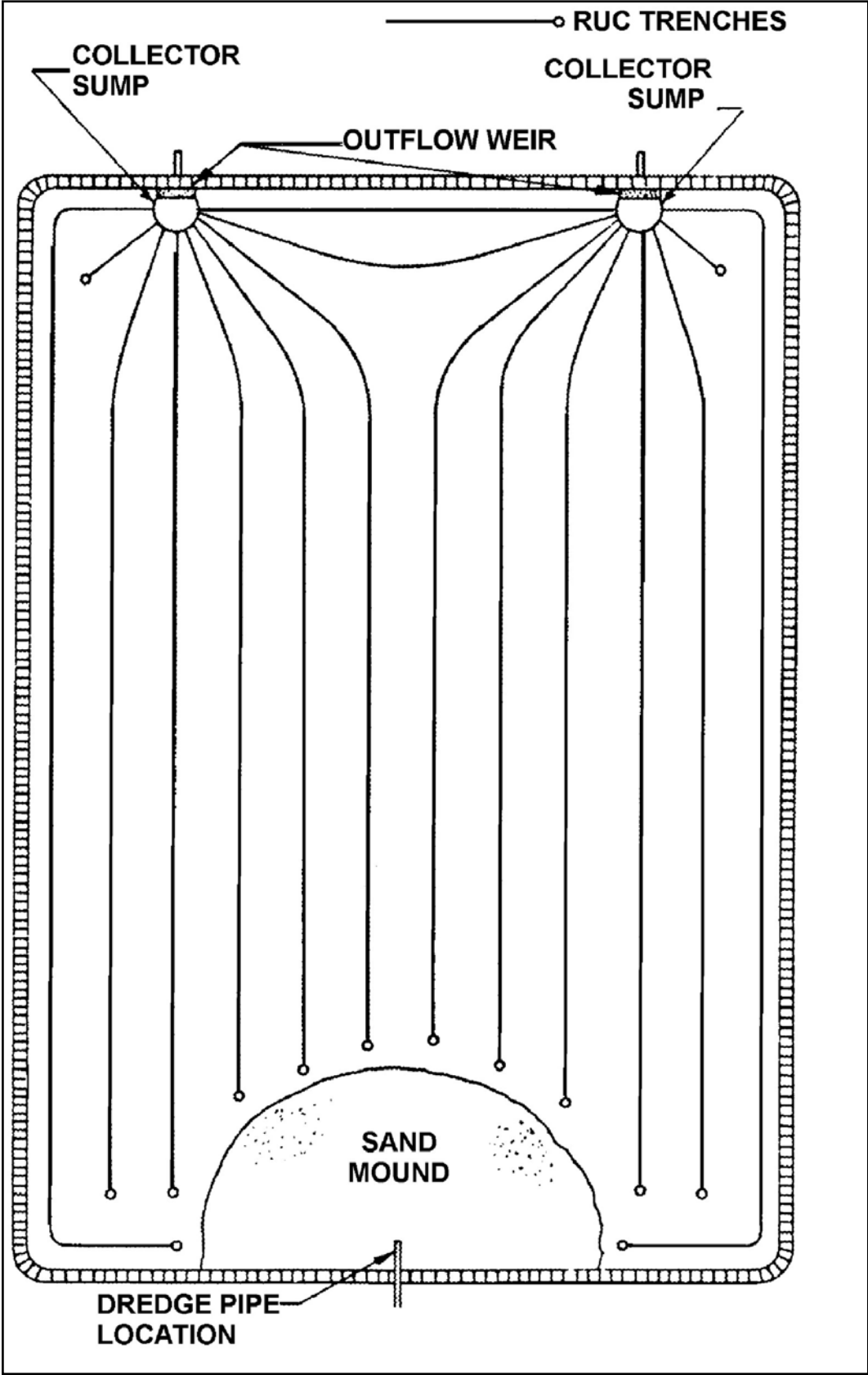

Figure 4-45. Combination Radial-Parallel Trenching Scheme

d. Parallel trenching. The most common trench pattern employs parallel trenching. A complete circuit of the placement area with a perimeter trench is joined with parallel trenches cut back and forth across the placement area, ending in the perimeter trench. Spacing between parallel trenches can be varied as described earlier. A parallel pattern is illustrated in Figure 4-44. A schematic of a parallel trenching pattern with radial combinations is shown in Figure 4-45.

e. Radial trenching pattern. Small placement areas or irregularly shaped placement areas may be well suited for a radial trenching pattern for effective drainage of water to the weir structures. The radial patterns should run parallel to the direction of the surface slopes existing within the area. Radial trenching patterns can also be used to provide drainage from localized low spots to the main drainage trench pattern. When the placement area is extremely large in areal extent or when interior cross dikes or other obstructions exist within the placement area, sequential sets of radial trenches may be constructed, with the sets farthest into the placement area interior acting as collectors funneling into one of the radial trenches extending from the outflow weir. This sequential radial trenching procedure is shown in Figure 4-46, as constructed in the South Blakely Island Placement Site of the Mobile District.

#### 4.6 Design and Construction of Retaining Dikes and Structures.

##### 4.6.1 General considerations.

##### 4.6.1.1 Purpose and description.

a. Containment dikes are retaining structures used to form confined disposal facilities. The principal objective of a dike is to retain solid particles and pond water within the placement area while at the same time allowing the release of clarified effluent to natural waters. The location or alignment of a containment dike is usually established by site constraints. The heights and geometric configurations of containment dikes are generally dictated by containment capacity requirements, availability of construction materials, site restrictions, and prevailing foundation conditions.

b. The predominant retaining structure in a containment facility extends around the outer perimeter of the containment area and is referred to as the main dike. Except as otherwise noted, all discussion in this chapter applies to the main dike. Cross and spur dikes can also be constructed to divide the site or increase site effectiveness.

c. The engineering design of a dike includes selection of location, height, cross section, material, and construction method. The selection of a design and construction method are dependent on project constraints, foundation conditions, material availability, and availability of construction equipment. The final choice will be a selection among feasible alternatives.



Figure 4-46. Aerial View of the Sequential Radial Trenching Procedure Used when Interior Cross Dikes are Encountered, South Blakely Island Placement Site, Mobile District

d. The development of an investigation for the dike foundation and the proposed borrow areas, the selection of a foundation preparation method, and the design of the embankment cross section require specialized knowledge in soil mechanics. Therefore, all designs and specifications should be prepared under the direct supervision and guidance of a geotechnical engineer. Proposed cross-section designs should be analyzed for stability as cross sections are affected by foundation and/or embankment shear strength, settlement caused by compression of the foundation and/or the embankment, seismic conditions, and external erosion. Seismic conditions should be considered an integral part of dike design. The extent to which the site investigation and design studies are carried out is dependent, in part, on the desired margin of safety against failure. This decision is usually made by the local design agency and is affected by a number of site-specific factors.

e. Dikes for upland CDF normally consist of earth-fill embankments.

f. Containment dikes for nearshore sites must consider site-specific geotechnical conditions, wave effects, maintenance requirements, and seismic effects. Most Puget Sound in-water dikes have used sand and gravel as fill material. Soft foundation material along the center line of the berm may require excavation prior to placement of the fill to provide a suitable base for the berm. Rock fill dikes are more commonly found in the Great Lakes. Structures such as sheet pile walls or cellular cofferdams have also been used for nearshore CDFs.

g. For CDFs situated in the water, the retaining dikes require protection from erosion due to waves. This erosion protection is generally an armor layer made of rock; the size and extent (and cost) are a function of the severity of the wave climate. Depending on the size of the waves, the armor layer can have more than one layer of rock, progressing from small rock or gravel on an inner layer to the largest rock on the outer layer.

h. Engineering design of the CDF armor layer requires, at a minimum, defining the water depth where the CDF will be located, determining the wave climate and selecting a design wave, determining water levels, and deciding if wave runup and overtopping need to be considered. From this information, the stable rock size, number of rock layers, and extent of the armor layer both above and below the water line can be determined. The depth of water in which the CDF is located can also have a major impact on the CDF erosion protection design. As water depths increase, costs often increase due to the increased potential for larger waves.

i. In designing the armor layer for an in-water CDF, the most important information required is the wave climate. Based on the wave climate, a design wave is generally selected. The design wave is often the most severe wave expected in a return period ranging from 50 to 100 years. A risk-based approach, balancing expected damages against initial costs, is often used to determine the optimum design. Other factors relating to water levels and waves also need to be considered in the design of the CDF erosion protection. Knowledge of the potential changes in water level, caused primarily by tides and wind setup, is required. If the CDF is adjacent to shipping lanes, waves generated from passing vessels may be a concern. The combination of waves and water levels determines runup, which influences how high up the dike the erosion protection should extend. Depending on the height of the dike, waves can run up over the top of the dike.



j. CDF armor layer design should be conducted by an experienced coastal engineer, assisted by geotechnical engineers. The design of the armor layer should be integrated with the CDF dike design.

#### 4.6.1.2 Types of containment dikes.

a. Main dike. The predominant retaining structure in a containment facility extends around the outer perimeter of the containment area and is referred to as the main dike. Except as otherwise noted, all discussion in this chapter applies to the main dike. The main dike and two other types of dikes, cross and spur dikes, which serve primarily as operational support structures for the main dike, are shown in Figure 4-47.

b. Cross dike. A cross, or lateral, dike (Figure 4-47) is placed across the interior of the containment area, connecting two sides of the main dike. This permits the use of one area as an active placement area while another area may be used solely for dewatering. Another use of cross dikes is to separate the facility so that the slurry in one area is subjected to initial settling prior to passing over or through the cross dike to the other area. In order to accomplish this, the cross dike is placed between the dredged discharge point and the sluice discharge. A cross dike can also be used with a Y-discharge line to divide an area into two or more areas, each receiving a portion of the incoming dredged material.

c. Spur dike. Spur, or finger, dikes protrude into, but not completely across, the placement area from the main dike, as shown in Figure 4-47. They are used mainly to prevent channelization by breaking up a preferred flow path and dispersing the slurry into the placement area. Spur dikes are also used to allow simultaneous discharge from two or more dredges by preventing coalescence of the two dredged material inputs, and thereby discouraging an otherwise large quantity of slurry from reaching flow velocities necessary for channelization.

4.6.1.3 Factors affecting design. The engineering design of a dike includes the selection of location, height, cross section, material, and construction method. The selection of a design and construction method are dependent on project constraints, foundation conditions, material availability, and availability of construction equipment. The final choice will be a selection from feasible alternatives.

a. Project constraints. Several constraints on design are placed by the overall project needs. Available construction time and funding are always factors. The location, height, and available space for the containment dike are usually dictated by project requirements that are discussed elsewhere in this manual. The design factor of safety against structural failure is usually specified. Environmental safety and aesthetics must also be considered.

b. Foundation conditions. The lateral and vertical distribution of shear strength, compressibility, permeability, and stratification of potential foundation materials are major factors in dike design.

31 Jul 15

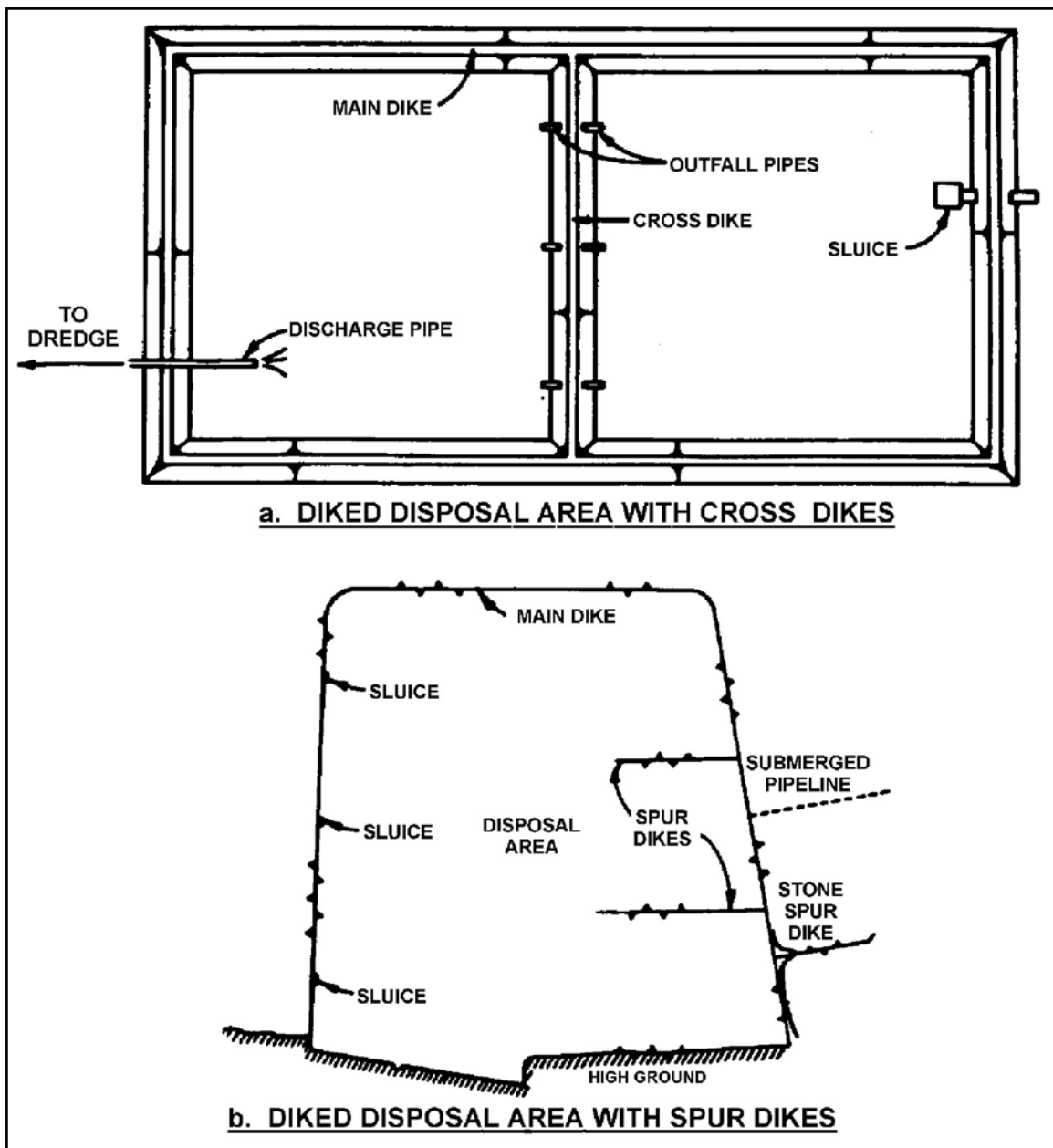

Figure 4-47. Examples of Cross and Spur Dikes

c. Availability of materials. All potential sources of construction materials for the embankment should be characterized according to location, type, index properties, and ease of recovery. Available placement sites are often composed in the near-surface of soft clays and silts of varying organic content. Since economical dike construction normally requires the use of material from inside the placement area and/or immediately adjacent borrow areas, initial dike heights may be limited, or it may be necessary to use rather wide embankment sections, expensive foundation treatment, or expensive construction methods.

d. Availability of equipment. Although common earthwork equipment is generally available, the specialized equipment for the soft soils desirable for use at containment sites may not be available to meet the project schedule, or the mobilization cost may be excessive. Less expensive alternatives should then be considered.

4.6.1.4 Construction methods. Each type of construction method has characteristics that can strongly affect dike design. The soil material to be placed in the dike section is transported by hauling, casting, or dredging. It is then compacted, semicompacted, or left uncompacted. The selection of a construction method, even though based on economics, must also be compatible with available materials, available equipment, geometry of the final dike section, and environmental considerations.

#### 4.6.2 Foundation investigation.

4.6.2.1 The extent to which site investigations and design studies are carried out depends, in part, on the desired margin of safety against failure. This decision is usually made by the local design agency and is affected by a number of site-specific factors. Table 4-3 lists some general factors, based on engineering experience, that can be used as general guidelines in the planning stage of a project.

Table 4-3. Factors Affecting the Extent of Field Investigations and Design Studies

Factor	Field Investigations and Design Studies Should be More Extensive Where:
Construction experience	There is little or no construction experience in the area, particularly with respect to dikes.
Consequence of failure	Consequences of failure involving life, property, or damage to the environment are great.
Dike height	Dike heights are substantial.
Foundation conditions	Foundation deposits are weak and compressible. Foundation deposits are highly variable along the alignment. Underseepage and/or settlement problems are severe.
Borrow materials	Available borrow is of poor quality, water contents are high, or borrow materials are variable along the alignment.
Structure in dikes	Sluices or other structures are incorporated into the dike embankment and/or foundation.
Utility crossings	Diked area is traversed by utility lines.

4.6.2.2 Foundation exploration. The purpose of the foundation exploration is similar to that for the containment area, as defined in paragraph 4.2.2—to define dike foundation conditions including depth, thickness, extent, composition, and the engineering properties of the foundation strata. The exploration is made in stages, each assembling all available information from a given source prior to the planning and start of the next, more expensive stage. The usual sequence of

the foundation exploration is shown in Table 4-4. Additional guidance on the number, depth, and spacing of exploratory and/or final phase borings is given in Hammer and Blackburn (1977), EM 1110-2-2300, American Society of Civil Engineers Manual No. 56 (ASCE 1976), and various geotechnical engineering textbooks. Geophysical exploration methods are described in EM 1110-1-1802.

4.6.2.3 Field and laboratory tests. Field soils tests are often made during exploratory boring operations. Commonly used field tests are given in Table 4-5. Disturbed samples from exploratory and final phase borings are used for index properties tests. Samples from undisturbed sample borings are used in laboratory tests for engineering properties. Commonly used laboratory tests are given for fine-grained soils in Table 4-6 and for coarse-grained soils in Table 4-7. Additional guidance on field soil sampling methods is given in EM 1110-2-1907 and on laboratory soils testing in EM 1110-2-1906.

Table 4-4. Stages of Field Investigation

Preliminary Geological Stage Features	Subsurface Exploration Stage Features
<u>Office study</u> Collection and study of the following: <ul style="list-style-type: none"> <li>- Topographic, soil, and geological maps</li> <li>- Aerial photographs</li> <li>- Boring logs and well data</li> <li>- Information on existing engineering projects</li> </ul>	<u>Exploratory phase and field testing</u> <ul style="list-style-type: none"> <li>- Widely but not uniformly spaced disturbed sample borings (may include split-spoon penetration tests) geologic study</li> <li>- Test pits excavated by backhoes, farm tractors, or dozers</li> <li>- Geophysical surveys to interpolate between widely spaced borings</li> <li>- Borehole geophysical tests</li> <li>- Water table observations</li> </ul>
<u>Field survey</u> Observations and geology of area, documented by written notes and photographs, including such features as the following: <ul style="list-style-type: none"> <li>- Riverbank and coastal slopes, rock outcrops, earth and rock cuts or fills</li> <li>- Surface materials</li> <li>- Poorly drained areas</li> <li>- Evidences of instability of foundations and slopes</li> <li>- Emerging seepage and/or soft spots</li> <li>- Natural and man-made physiographic features</li> </ul>	<u>Final phase</u> <ul style="list-style-type: none"> <li>- Additional disturbed sample borings including split-spoon penetration tests</li> <li>- Undisturbed sample borings</li> <li>- Field vane shear tests for soft materials</li> </ul>

Table 4-5. Preliminary Appraisal of Foundation Strengths

Method	Remarks
Penetration resistance from standard penetration test	<ul style="list-style-type: none"> <li>- In clays, provides data helpful in a relative sense (that is, in comparing different deposits); generally not helpful where the number of blows per foot <math>N^*</math> is low.</li> <li>- In sand, N-values less than about 15 indicate low relative densities.</li> </ul>
Natural water content of disturbed or general type samples	<ul style="list-style-type: none"> <li>- Useful when considered with soil classification and previous experience is available.</li> </ul>
Hand examination of disturbed samples	<ul style="list-style-type: none"> <li>- Useful where experienced personnel are available who are skilled in estimating soil shear strengths.</li> </ul>
Position of natural water contents relative to LL and PL	<ul style="list-style-type: none"> <li>- If natural water content is close to PL, foundation shear strength should be high.</li> </ul>
Field pumping tests used to determine field permeability	<ul style="list-style-type: none"> <li>- Natural water contents near LL indicate sensitive soils with low shear strengths.</li> </ul>
Torvane or pocket penetrometer tests on intact portions or general samples	<ul style="list-style-type: none"> <li>- Easily performed and inexpensive, but results may be excessively low; useful for preliminary strength estimates.</li> </ul>
Vane shear tests	<ul style="list-style-type: none"> <li>- Useful where previous experience is available.</li> <li>- Used to estimate shear strengths.</li> </ul>

Table 4-6. Laboratory Testing of Fine-Grained Cohesive Soils

Type Test	Purpose	Scope of Testing
Visual classification	- Classify the soil visually in accordance with the Unified Soil Classification System (USCS)	- All samples
Water content	- Determine the water content of the soil in order to better define soil profiles, variation with depth, and behavioral characteristics	- All samples
Atterberg limits	- <u>Foundation soils</u> : For classification, compare with natural water contents or correlate with shear or consolidation parameters - <u>Borrow soils</u> : For classification, compare with natural water contents or correlate with optimum water content and maximum dry densities	- Representative samples of foundation and borrow soils; sufficient samples should be tested to develop a good profile with depth
Compaction	- Establish maximum dry density and optimum water content	- Representative samples of all borrow soils for compacted or semicompacted dikes: - Compacted—Perform a standard 25-blow test - Semicompacted—Perform a 15-blow test
Consolidation	- Determine parameters necessary to estimate settlement of dike and/or foundation and time-rate of settlement; also to determine whether soils are normally consolidated or overconsolidated and to aid in estimating strength gain with time	- Representative samples of compacted borrow where consolidation of dike embankment itself is expected to be significant - Representative samples of foundation soils where such soils are anticipated to be compressible - On samples of fine-grained adjacent and/or underlying materials at structure locations
Permeability	- Estimate the perviousness of borrow and/or foundation soils in order to calculate seepage losses and time-rate of settlement	- Generally not required for fine-grained cohesive soils as such soils can be assumed to be essentially impervious in seepage analyses. Can be computed from consolidation tests
Shear strength	- Provide parameters necessary for input into stability analysis - Pocket penetrometer, miniature vane, unconfined compression, and Q-tests to determine unconsolidated-undrained strengths - R-tests to determine consolidated-undrained strengths - S-tests to determine consolidated-undrained strengths	Pocket penetrometer and miniature vane (Torvane) for rough estimates - Unconfined compression tests on saturated foundation clays without joints, fissures, or slickensides - Appropriate Q- and R-triaxial and S-direct shear tests on representative samples of both foundation and compacted borrow soils

Table 4-7. Laboratory Testing of Coarse-Grained Noncohesive Soils

Test	Purpose	Scope of Testing
Visual classification	- Visually classify the soil in accordance with the USCS	- All samples
Gradation	- Determine grain-size distribution for classification	- Representative samples of foundation and borrow materials
Relative density or compaction	- Determine minimum-maximum density values or maximum density and optimum water content values; should use the test which gives greatest values of maximum density	- Representative samples of all borrow materials
Consolidation	- Provide parameters necessary for settlement analysis	- Not generally required as pervious soils consolidate rapidly under load and post-construction magnitude is usually insignificant
Permeability	- Provide parameters necessary for seepage analysis	- Not usually performed as correlations with grain size - Are normally of sufficient accuracy - Where underseepage problems are very serious, best to use results from field pumping test
Shear strength	- Provide parameters necessary for stability analysis	- Representative samples of compacted borrow and foundation soils. - Consolidated-drained strengths from S-direct shear or triaxial tests are appropriate for free-draining pervious soils.

#### 4.6.3 Construction materials.

##### 4.6.3.1 Acceptable materials.

a. Almost any type of soil material is acceptable (even though not the most desirable) for construction of a retaining dike, with the exception of very wet fine-grained soils and those containing a high percentage of organic matter. High plasticity clays may present a problem because of detrimental swell-shrink behavior when subjected to cycles of wetting and drying.

b. Either fine-grained soil materials of high water content must be dried to a water content suitable for the desired type of construction or the embankment design must take into account the fact that the soil has a high water content and is, therefore, soft and compressible. Because the drying of soils is very expensive, time consuming, and highly weather dependent, the design should incorporate the properties of the soil at its natural water content or should require only a minimum of drying. When the dike fill is to be compacted, the borrow material must have a

sufficiently low water content so that placement and machine compaction can be done effectively. Semicompacted fill can tolerate fine-grained soils with higher water contents while uncompacted (cast) fine-grained fill can be placed at even higher water contents. Since dike construction is normally done in low, wet areas, problems with materials being too dry are rarely encountered.

4.6.3.2 Material sources. A careful analysis of all available material sources—including location, material type, and available volume—should be made. Possible sources include any required excavation area, the material adjacent to the dike toe, a central borrow area, and material from maintenance dredging operations.

a. Required excavation. Soil material from required excavations should be given first consideration since it must be excavated and disposed of anyway. Included in this category is material from adjacent ditches, canals, and appurtenant structures as well as material from inside the containment area. This usage also eliminates the problem of dealing with borrow areas left exposed permanently after project completion.

b. Material adjacent to dike toe. This is the most common source of dike material because it involves a short-haul distance. Hauling can be eliminated by the use of a dragline-equipped crane. Dike stability can be seriously affected if the excavation is made too close to the toe. A berm is usually left in place between the toe of the dike and the excavation to ensure dike stability and to facilitate construction. The required width of the berm should be based on a stability analysis.

c. Central borrow area. When sufficient material cannot be economically obtained from required excavations or the dike toe, a central borrow area is often used. This may be within the containment area, or it may be offsite. A central borrow pit within the containment area serves to increase available containment volume. Central borrow areas can be used for either hauled or hydraulic fill dikes. Dredging from a water-based central borrow pit is usually economical for hydraulic fill dikes. Usually a deeper pit with smaller surface area is preferred since this requires less movement of the dredge.

d. Maintenance dredging. Maintenance dredging can be a very economical source of borrow material. The coarse-grained materials from maintenance dredging are desirable for dike construction. Zones around the dredge discharge usually provide the highest quality of material. However, fine-grained soils may not be suitable because of their very high water content and may require considerable drying. Previously placed dredged material from maintenance operations has been commonly used to raise existing dikes. It is readily available and serves to increase the capacity of the containment area.

4.6.3.3 Materials exploration and testing. All discussion of field investigation procedures, including an exploratory investigation of strength and the laboratory index properties tests given in Tables 4-4 through 4-7, is applicable to the characterization of potential embankment materials. The objective is to develop sufficient information regarding the various sources of fill material for a comparison among feasible alternatives.



4.6.4 Embankment design considerations. The development of an investigation for the dike foundation and for proposed borrow areas, the selection of a foundation preparation method, and the design of the embankment cross section require specialized knowledge in soil mechanics. Therefore, all designs and specifications should be prepared under the direct supervision and guidance of a geotechnical engineer and should bear his/her approval.

4.6.4.1 Factors in design. In addition to the project constraints described in paragraph 4.1.3, the site-specific factors that should be considered in the design of containment dikes are foundation conditions; dike stability with respect to shear strength, settlement, seepage, and erosion; available dike materials; and available construction equipment.

4.6.4.2 Dike geometry. The height and crown width of a dike are primarily dependent on project constraints generally unrelated to stability. Side slopes and materials allocation within the cross section are functions of foundation conditions, materials availability, and time available for construction.

4.6.4.3 Embankment and foundation stability. Proposed cross-section designs should be analyzed for stability as cross sections are affected by foundation and/or embankment shear strength, settlement caused by compression of the foundation and/or the embankment, and external erosion. The analytic methods described and referenced herein contain procedures that have proven satisfactory from past use, and most are currently employed by the USACE. Specific details concerning methods for analyzing dike stability are reported in Hammer and Blackburn (1977) and in EM 1110-2-1902. Several computer programs are also available to USACE Districts to assist in stability analyses.

4.6.4.4 Seismic considerations. Special considerations for the design of dikes in seismically active areas, such as Puget Sound, are warranted. In general, containment dikes have performed reasonably well during past earthquakes. A commonly observed aspect is outward movement of the dike (as observed at the Oakland Airport during the Loma Prieta earthquake). Outward movement or sliding can occur due to reduced strength in the foundation materials (liquefaction), reduced strength in the dike itself, and inadequate estimation of the loads imposed by the contained fill. A sequence of steps should be followed in evaluating ground motions and performing seismic analyses for earth, concrete, and steel structures (after Krinitzky, Hynes, and Franklin 1997).

4.6.4.5 Causes of dike instability.

a. Inadequate shear strength. Most dike failures are caused by overstressing the low shear strength soils in the dike and/or the foundation (often coupled with seepage effects). Failures of this type can be the most catastrophic and damaging since they usually occur quickly and can result in the loss of an entire section of the dike along with the contained dredged material. These failures may involve the dike alone, or they may involve both the dike and the foundation. Thus, two forms of instability may occur.

(1) Where the foundation is much stronger than the embankment, the dike slope can fail in a rotational slide tangent to the firm base, as shown in Figure 4-48. However, if a much weaker

31 Jul 15

horizontal plane or layer exists at or near the contact between the dike fill and the foundation, the failure may be a translation type, taking the form of a sliding wedge, as shown in Figure 4-49.

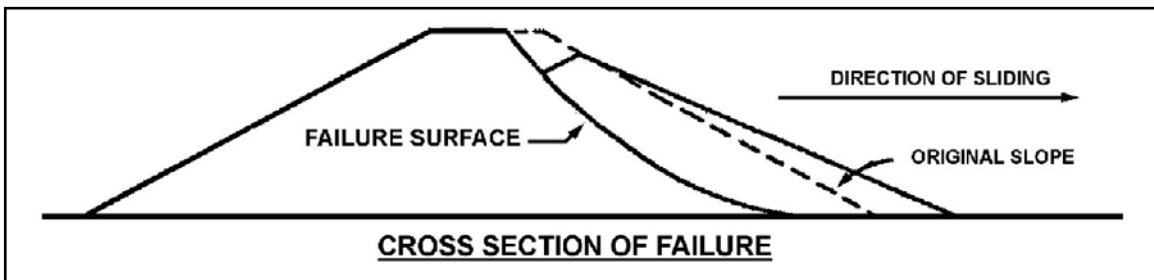

Figure 4-48. Rotational Failure in a Dike

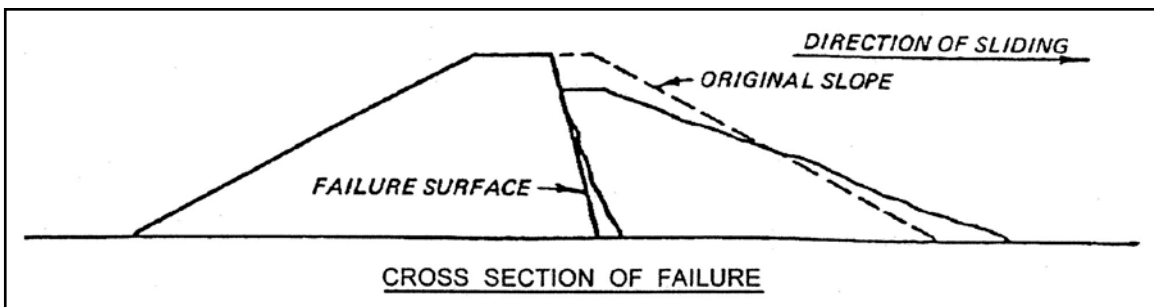

Figure 4-49. Translatory Failure in a Dike

(2) When the strength of the foundation is equal to or less than that of the fill, a rotational sliding failure that involves both the fill and the foundation may occur, as shown in Figure 4-50. If the foundation contains one or more weaker horizontal planes or layers, then a translation type failure in the form of a sliding wedge may occur, as shown in Figure 4-51.

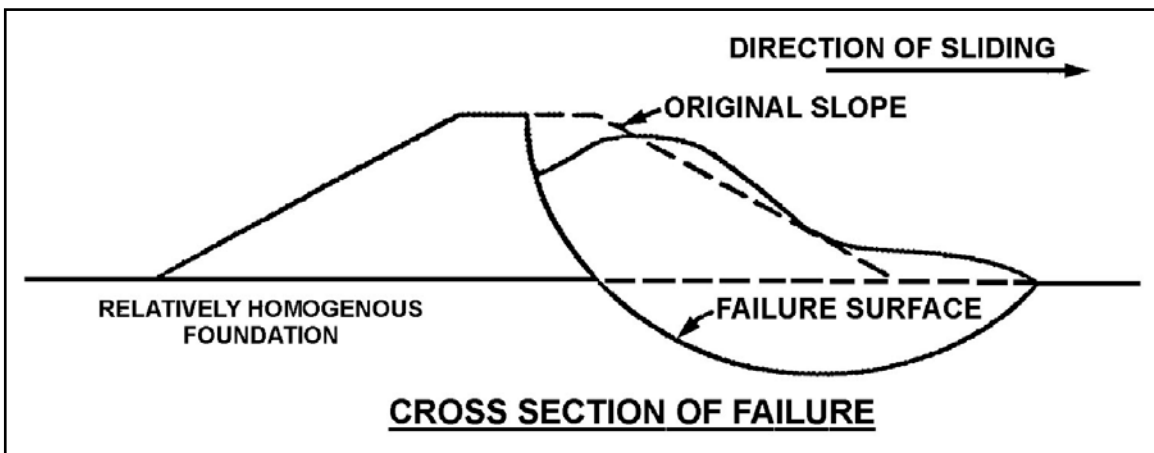

Figure 4-50. Rotational Failure in both a Dike and its Foundation

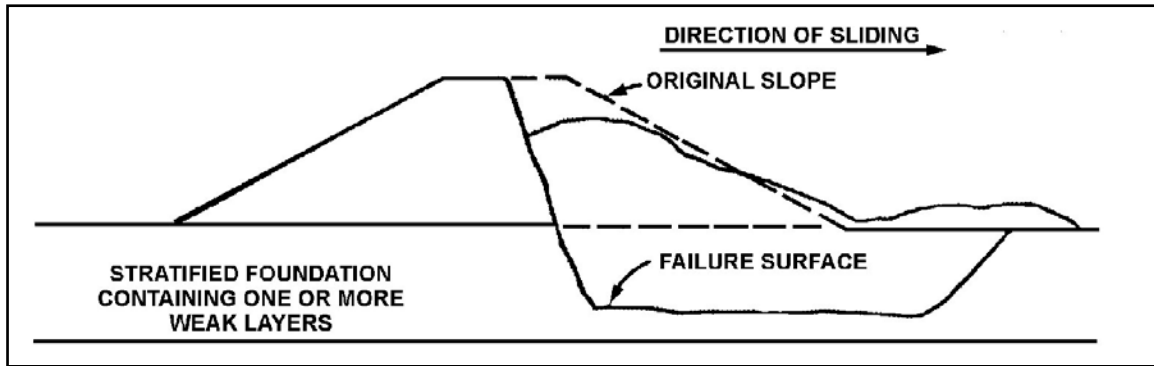

Figure 4-51. Translatory Failure in both a Dike and its Foundation

(3) Recommended minimum factors of safety and applicable shear strength tests for slope stability analyses of containment dikes are given in Table 4-8. These values are to be used where reliable subsurface data from a field exploration and laboratory testing program are available for input to a stability analysis. The factors of safety given in Table 4-8 are applicable to dikes less than 9 m (30 ft) in height where the consequences of failure are not severe. For dikes greater than 9 m (30 ft) in height and where the consequences of failure are severe, the criteria given in Table 1 of EM 1110-2-1902 should be used.

Table 4-8. Applicable Shear Strengths and Recommended Minimum Factors of Safety<sup>1</sup>

Condition	Shear Strength			Minimum Factor of Safety <sup>2</sup>	
	Impervious Soils <sup>3</sup>	Draining Soils	Slope Analyzed	Main Dikes	Appurtenant Dikes
End of Construction	Q	S	Exterior and Interior	1.3 <sup>4</sup>	1.3
Steady seepage	Q, R <sup>5</sup>	S	Exterior	1.3	1.2
Sudden drawdown	Q, R <sup>5</sup>	S	Exterior	1.0	NA

<sup>1</sup> These criteria are not applicable to dikes greater than 9 m (30 ft) in height or where the consequences of failure are very severe. For such dikes, use the criteria given in Table 1 of EM 1110-2-1902.

<sup>2</sup> To be applied where reliable subsurface data from exploration and testing are available; where assumed values are used, recommended minimum factors of safety should be increased by a minimum of 0.1.

<sup>3</sup> For low-plasticity silt where consolidation is expected to occur rather quickly, the R strength may be used in lieu of the Q strength.

<sup>4</sup> Use 1.5 where considerable lateral deformation of foundation is expected to occur (usually where foundations consist of soft, high-plasticity clay).

<sup>5</sup> Use Q strength where it is anticipated that loading condition will occur prior to any significant consolidation taking place; otherwise, use R strength.

(4) When the foundation soils are very soft, as is often the case, various design sections are used to provide stability, as shown in Figure 4-52. A floating section, with very flat slopes and often a berm, may be used. The settlement of this section may become detrimental. The soft foundation may be displaced by the firmer dike material, or the soft foundation may be removed and replaced with compacted fill.

31 Jul 15

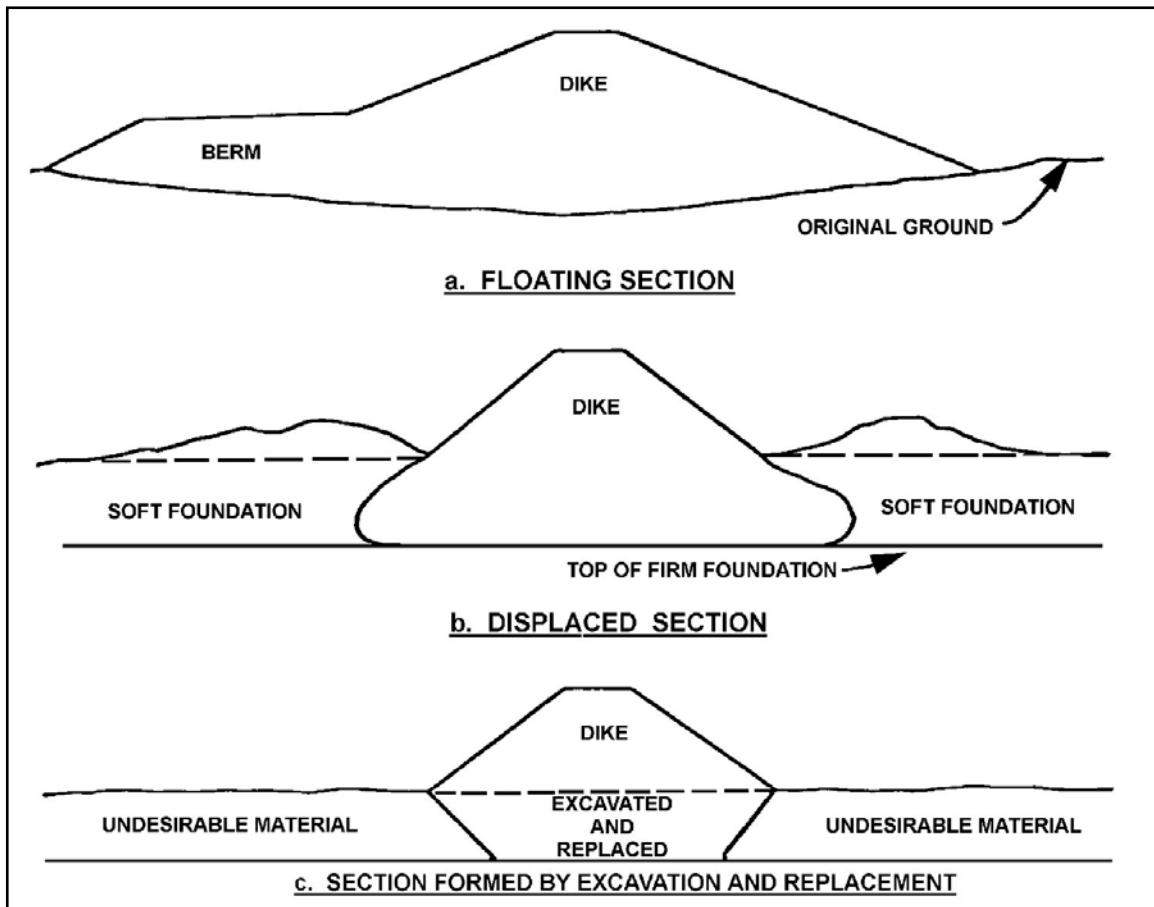

Figure 4-52. Basic Methods of Forming Dike Sections for Stability

b. Seepage. Potentially detrimental seepage can occur through earth dikes and foundations consisting of pervious or semipervious materials unless prevented by positive means such as impervious linings, blankets, or cutoffs. Seepage effects can create instability through internal erosion (piping) of the dike or foundation materials, or they may lead to a shear failure by causing a reduction in the shear strength of the dike and/or foundation materials through increased pore water pressure or by the introduction of seepage forces. The following conditions may create or contribute to seepage problems in containment dikes:

c. Dikes with steep slopes composed of coarse-grained pervious materials or fine-grained silt. The seepage surface through the embankment may exit on the outer slope above the dike toe, as shown in Figure 4-53, resulting in raveling of the slope. If the dike contains alternating layers of pervious and impervious materials, the seepage surface may even approach a horizontal line near the ponding surface elevation, as shown in Figure 4-54, creating a potentially severe seepage problem.

d. Dikes built on pervious foundation materials or where pervious materials are near the surface or exposed as a result of nearby excavation. As shown in Figure 4-55, this is a common condition where material adjacent to the dike toe is used for the embankment. This condition may lead to the development of large uplift pressures beneath and at the outer toe of the dike,

causing overall instability from inadequate shear strength, or it may result in piping near the embankment base. Methods for analyzing this condition are reported in U.S. Army Engineer Waterways Experiment Station (1956).

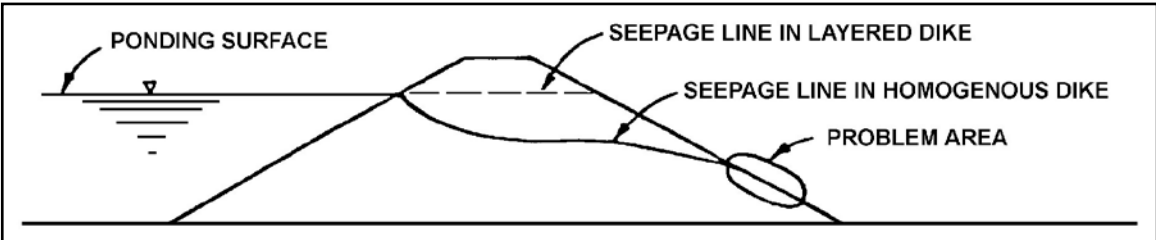

Figure 4-53. Seepage Lines Through a Dike

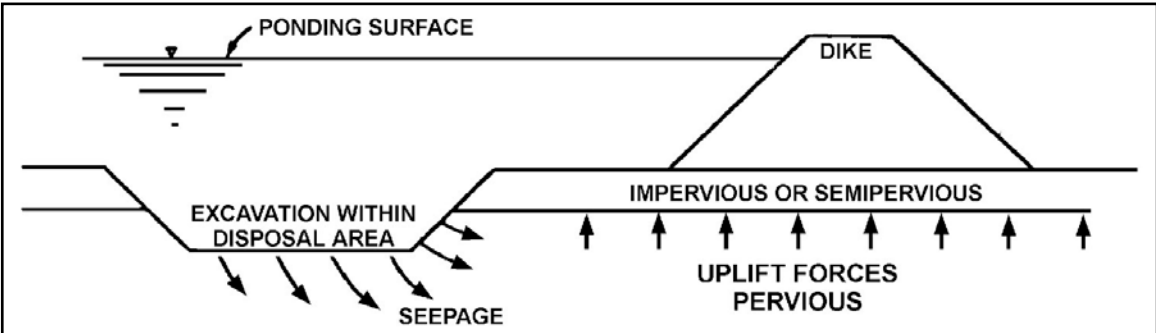

Figure 4-54. Seepage Entrance Through an Area Excavated Within a Placement Area

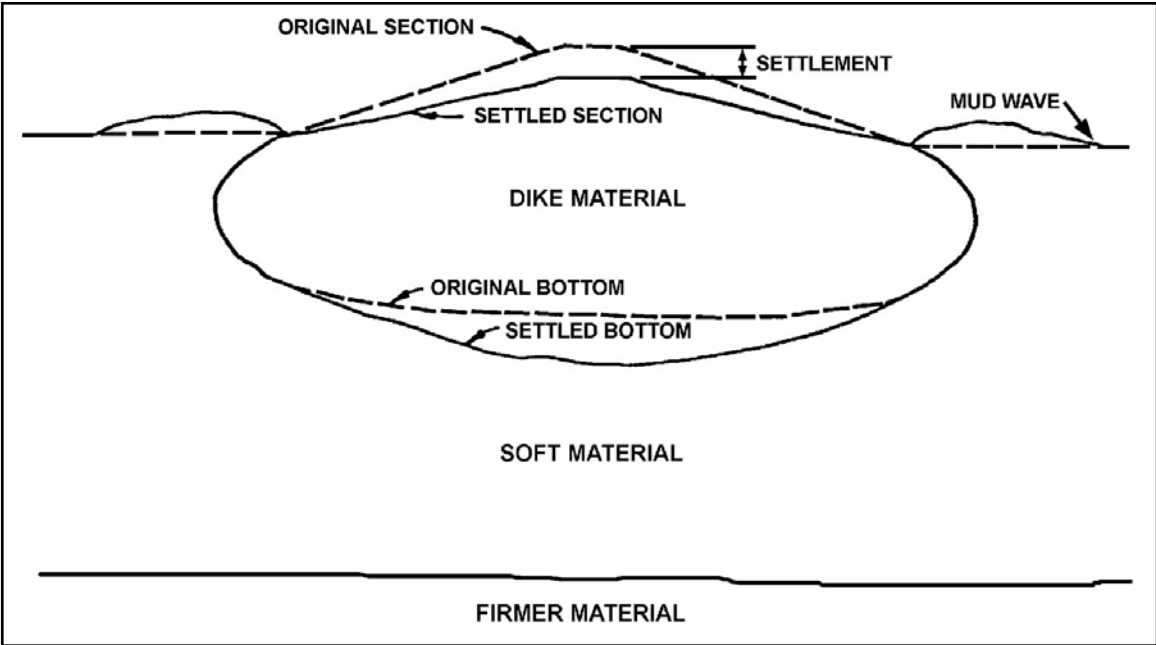

Figure 4-55. Example of Excessive Uniform Settlement

e. Dikes constructed by casting methods with little or no compaction. When used with fine-grained soils, this method of construction may leave voids within the dike through which water can flow freely, resulting in piping of dike material.

f. The existence of seepage paths along the contact between structures touching the dike. This condition can be caused by inadequate compaction of the dike materials, shrinkage of material adjacent to structures, or differential settlement. As in the previous case, piping of the dike material often results in and normally leads to breaching of the dike.

#### 4.6.4.6 Dike settlement.

a. Settlement of dikes can result from consolidation of foundation and/or embankment materials, shrinkage of embankment materials, or lateral spreading of the foundation. Like uncontrolled seepage, settlement of a dike can result in failure of the dike, but it will more likely serve to precipitate failure by another mode, such as seepage or shear failure. Consolidation, shrinkage, and some lateral deformation occur over a period of time, directly related to the soil permeability and the load intensity. Some lateral deformation can occur quickly, however, particularly during construction using the displacement method. Settlement problems are almost always related to fine-grained soils (silts or clays). Settlement and/or shrinkage of coarse-grained soils (sand and gravel) is generally much less than for fine-grained soils and occurs quickly, usually during construction.

b. Specific forms of settlement that cause problems with dikes include excessive uniform settlement, differential settlement, shrinkage of uncompacted embankment materials, and settlement resulting from lateral deformation, or creep, of soft foundation soils. Excessive uniform settlement can cause a loss in containment area capacity as a result of the loss of dike height, as shown in Figure 4-55. Differential settlement can result in cracking of the dike, which can then lead to a shear or piping failure. This is an especially acute problem at the contact between a dike and an adjacent structure. Examples of differential settlement resulting from materials of different compressibility are shown in Figure 4-56. Embankment shrinkage in dikes built with fine-grained soils and placed by means of casting or hydraulic filling can result in volume reductions of as much as 35% as a result of evaporation drying.

4.6.4.7 Erosion. Retaining dike failures can be initiated by the effects of wind, rain, waves, and currents that can cause deterioration of exterior and interior dike slopes. The exterior slopes, which are exposed to constant or intermittent wave and/or current action of tidal or flood waters, are usually subject to severe erosion. Interior slopes may also suffer this form of erosion, particularly in large containment areas. The slopes of dikes adjacent to navigable rivers and harbors may be eroded by wave action from passing vessels.

a. Weathering. Erosion of dike slopes due to the effects of wind, rain, and/or ice is a continuing process. Although these forces are not as immediately severe as wave and current action, they can gradually cause extensive damage to the dike, particularly those dikes formed of fairly clean coarse-grained soils.

b. Placement operations. Normal placement operations can cause erosion of interior dike slopes near the pipeline discharge and/or exterior slopes at the outlet structures. The pipeline discharge of dredged material is a powerful eroding agent, particularly if the flow is not dispersed.

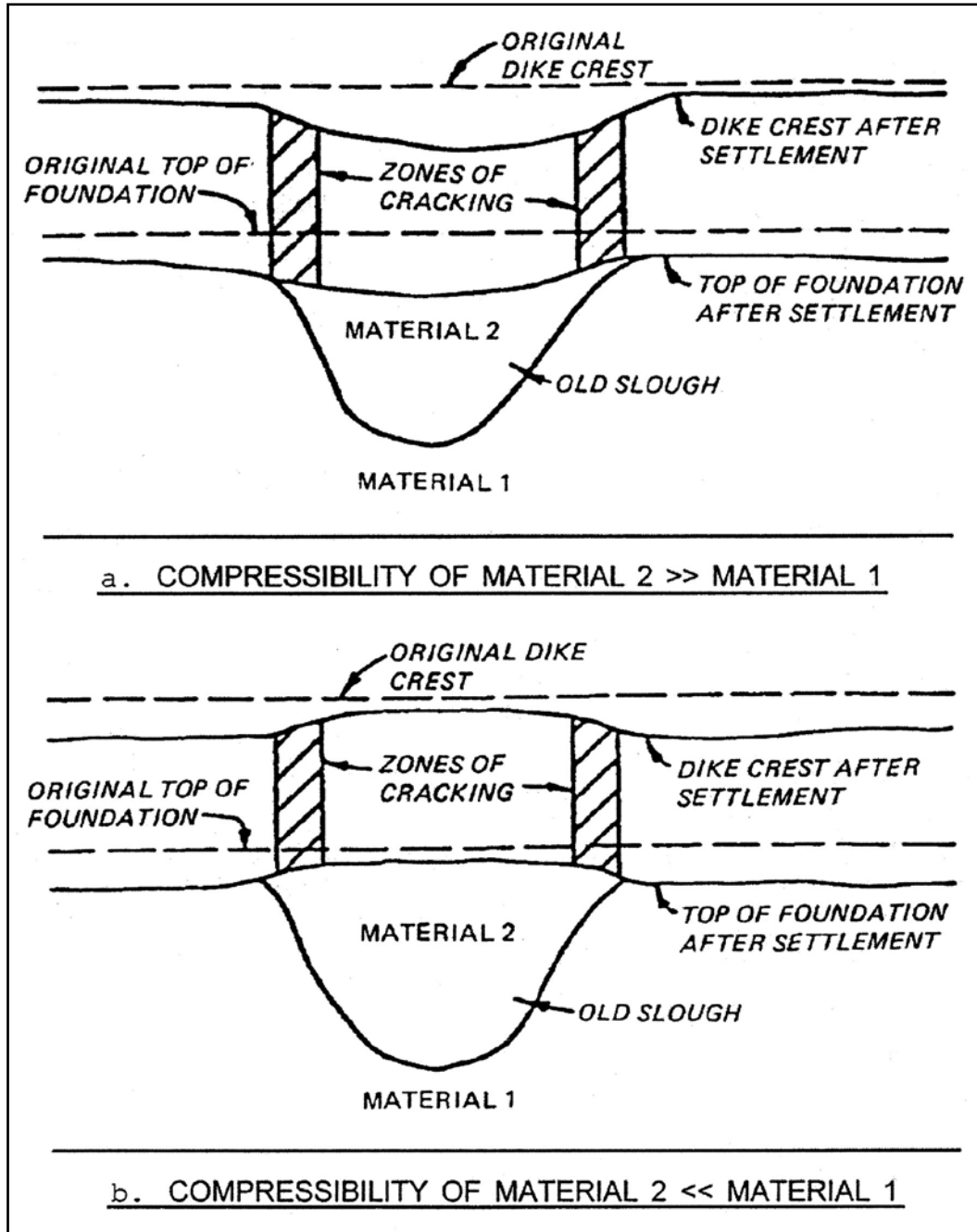

Figure 4-56. Differential Settlement from a Foundation Containing Materials of Different Compressibility

#### 4.6.4.8 Use of geotextiles.

a. Selection. Increasingly, geotextiles (permeable textile materials) are being used in dike construction to provide tensile reinforcement where it will increase the overall strength of the structure. The selection of geotextiles for use in a containment dike is usually based on a substantial cost savings over feasible, practical alternate solutions or on the improvement in performance of a design (for example, more effective installation, reduced maintenance, or increased life).

b. Stability analyses with geotextile reinforcement. Although the use of a geotextile as reinforcement introduces a complex factor into stability analyses, no specific analytic technique has yet been developed. Therefore, the conventional limited equilibrium-type analyses for bearing capacity and slope stability are used for the design of geotextile reinforced dikes. The bearing capacity analysis normally assumes the dike to be an infinitely long strip footing. Slope stability analyses, as described in EM 1110-2-1902, involve calculations for stability of a series of assumed sliding surfaces in which the reinforcement acts as a horizontal force to increase the resisting moment. Potential failure modes for fabric-reinforced dike sections are shown in Figure 4-57. Examples of stability analyses for geotextile reinforced embankments are given in Federal Highway Administration (undated).

4.6.4.9 Raising of existing dikes. The height to which a dike can be placed in one stage is sometimes limited by the weakness of the foundation. This limits the capacity of the containment area. The loading of the foundation due to the dike and/or dredged material causes consolidation, and consequent strength gain, of the foundation materials over a period of time. Thus, it is often possible to raise the elevation of an existing dike after some time. Construction of dikes in increments is usually accomplished by incorporating the initial dike into the subsequent dike, as shown in Figure 4-58a, or by constructing them on the dredged fill, at some distance from the inside toe of the existing dike, as shown in Figure 4-58b.

#### 4.6.5 Types of construction equipment.

4.6.5.1 Equipment types. Types of equipment commonly used in dike construction are listed in Table 4-9 according to the operation they perform. Some types of equipment are capable of performing more than one task, with varying degrees of success. Most of the equipment listed is commonly used in earthwork construction. However, because many dikes are founded on soft to very soft ground, low-ground-pressure versions of the equipment must usually be used in those areas. Specific information on general construction equipment may be found in EM 1110-2-1911. Guidance on equipment available for use on soft soils is given in Hammer and Blackburn (1977) and Green and Rula (1977) and on dredging equipment in Huston (1970).

4.6.5.2 Selection criteria. In the selection of equipment for any particular task, consideration should be given to the following:

- a. Quantity of the soil to be excavated, moved, or compacted.
- b. Type of soil to be excavated, moved, or compacted.



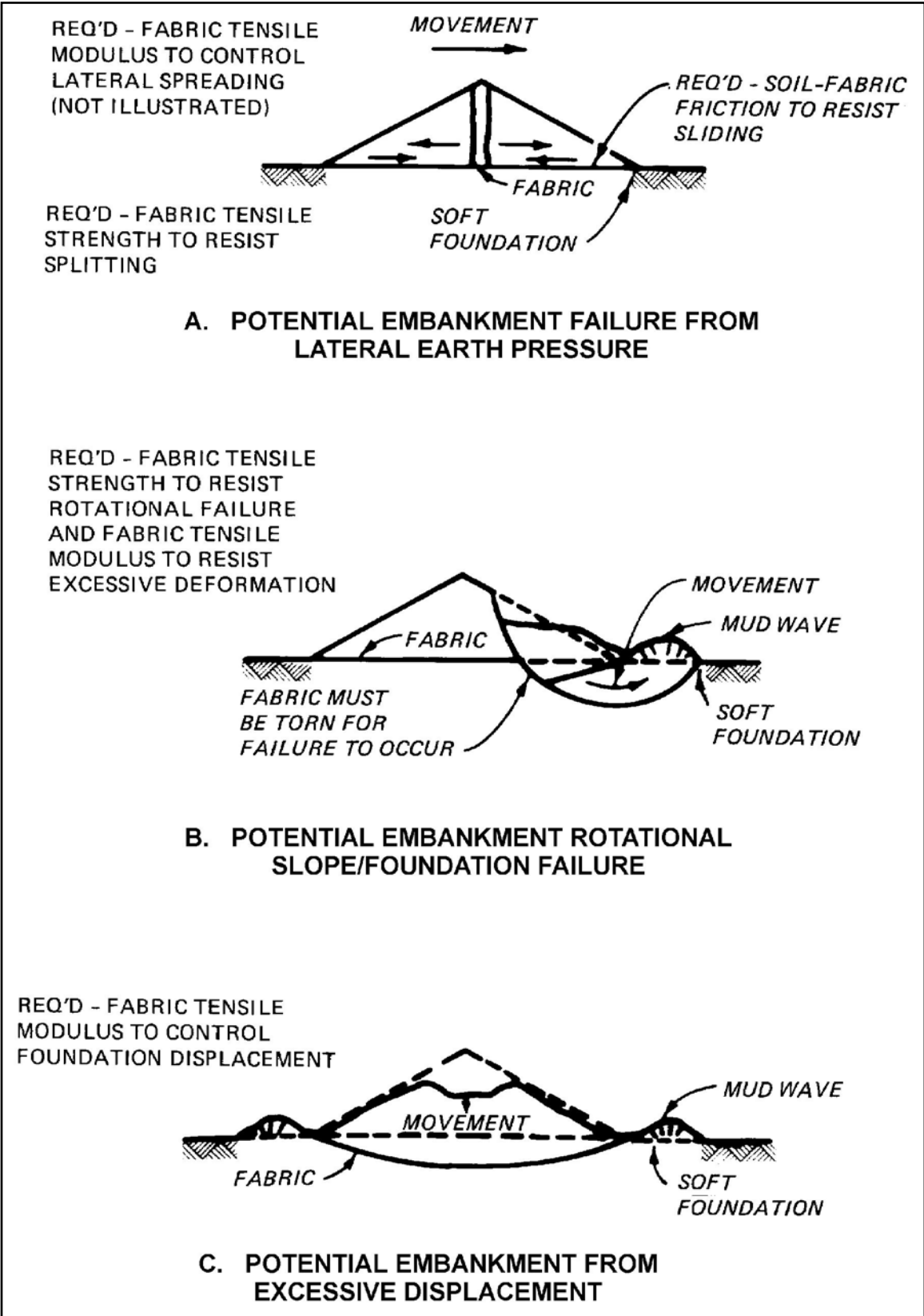

Figure 4-57. Potential Fabric-Reinforced Embankment Failure Modes

31 Jul 15

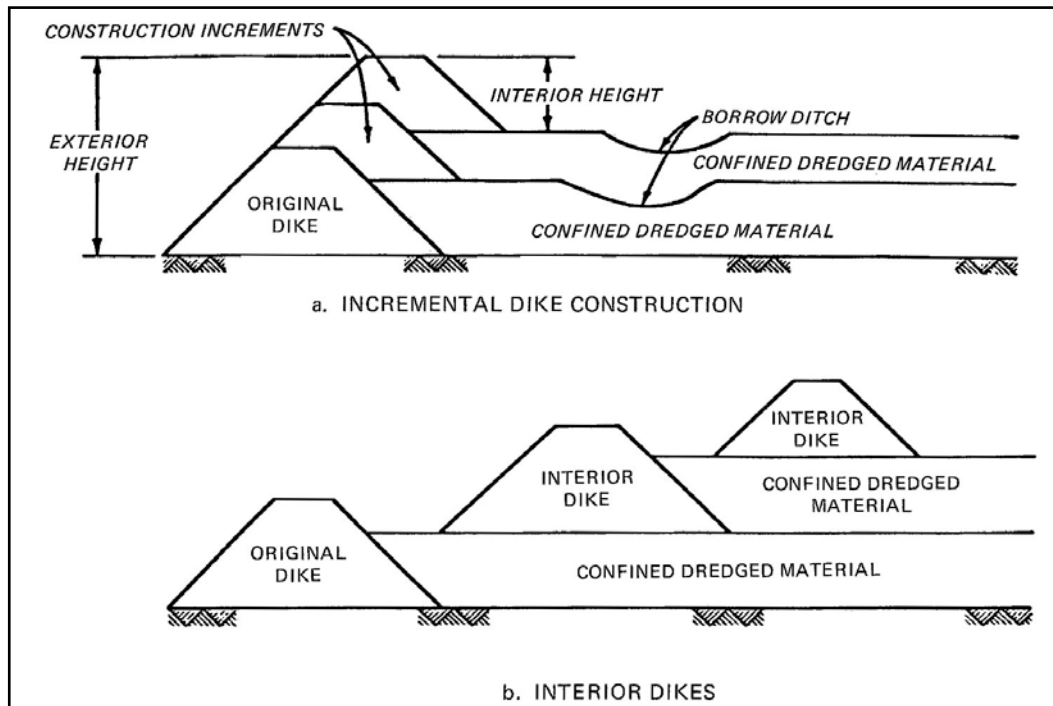

Figure 4-58. Dike-Raising Methods

Table 4-9. Equipment Commonly Used in Dike Construction

Operation	Equipment	Application
Excavation	Scraper	Firm to stiff soils; firm roadway
	Dragline	Soft soils that cannot support scrapers
	Dredge	Granular or soft soils
Transportation	Scraper	Hauling firm, moist soils
	Truck	Hauling firm, moist soils
	Dragline	Casting soft, wet soils
	Dredge	Pumping soils from below water
Scarification	Disc	Scarifying surface of compacted soil
Spreading	Scraper	Haul and spread from same machine
	Grader	Spread truck-hauled soils
	Crawler dozer	Used on soft terrain
Compaction	Sheepsfoot roller	Clays, silts, clayey or silty sands
	Pneumatic roller	Clays, silts, clayey or silty sands
	Vibratory roller	Clean sand; less than 10%
	Crawler tractor	All soils for semicompaction
	Hauling equipment	All soils for semicompaction
Shaping	Grader	Firm to stiff soils
	Crawler dozer	All soils; useful on soft soils
	Dragline	Rough shaping in very soft soils

- c. Consistency of the soils to be excavated, moved, or compacted.
- d. Distance the soil must be moved.
- e. Trafficability of the soils in the borrow, transport, and dike placement areas.
- f. Availability of equipment to fit the project time schedule.
- g. Purchase and operating costs.
- h. Auxiliary tasks or uses for the equipment.
- i. Maintenance needs; availability of parts.
- j. Standby or backup equipment needs.
- k. Time available for construction of the dike.
- l. Money available for construction of the dike.

4.6.6 Dike construction. The general construction sequence for a containment dike is normally foundation preparation, borrow area operations, transportation and placement of the dike materials in the embankment, and manipulation and possibly compaction of the materials to the final form and shape.

4.6.6.1 Factors in the method of construction. The choice of construction method for a containment dike is governed by available embankment materials, foundation conditions, trafficability of haul roads and the foundation, availability of construction equipment, and project economics.

4.6.6.2 Foundation preparation. The preparation of a dike foundation usually involves clearing, grubbing, and stripping. Some degree of foundation preparation is desirable to help ensure the integrity of the structure. Clearing and grubbing should be a minimum treatment for all projects. However, in marshy areas where a surface mat of marsh grass and roots exists over a typical soft clay layer, experience has shown that it is often more beneficial from a stability and construction standpoint to leave the mat in place rather than remove it even though this will leave a highly pervious layer under the dike.

a. Clearing. Clearing consists of the complete removal of all aboveground matter that may interfere with the construction and/or integrity of the dike. This includes trees, fallen timber, brush, vegetation, abandoned structures, and similar debris. Clearing should be accomplished well in advance of subsequent construction operations.

b. Grubbing. Grubbing consists of the removal of belowground matter that may interfere with the construction and/or integrity of the dike. This includes stumps, roots, buried logs, and other objectionable matter. All holes and/or depressions caused by grubbing operations should have

their sides flattened and should be backfilled to foundation grade in the same manner proposed for the embankment filling.

c. Stripping. After clearing and grubbing, the dike area is usually stripped to remove low-growing vegetation and the organic topsoil layer. This permits bonding of the fill soil with the foundation, eliminate a soft, weak layer that may serve as a translation failure plane, and eliminate a potential seepage plane. Stripping is normally limited to the dike location proper and is not usually necessary under stability berms. All stripped material suitable for use as topsoil should be stockpiled for later use on dike and/or borrow area slopes. Stripping is not normally required for dikes on soft, wet foundations or for dikes built by other than full compaction.

d. Disposal of debris. Debris from clearing, grubbing, and stripping operations can be disposed of by burning in areas where permitted. Where burning is not feasible, disposal is usually accomplished by burial in suitable areas, such as old sloughs, ditches, and depressions outside the embankment limits (but never within the embankment proper). Debris should never be placed in locations where it may be carried away by streamflow or where it may block drainage of an area. Material buried within the containment area must be placed so that no debris may escape and damage or block the outlet structure. All buried debris should be covered by a minimum of 0.9 m (3 ft) of earth.

e. Foundation scarification. For compacted dikes on firm foundations only, the prepared foundation should be thoroughly scarified to provide a good bond with the embankment fill.

4.6.6.3 Borrow area operations. Factors that should be considered in the planning and operation of a borrow area are site preparation, excavation, drainage, and environmental considerations.

a. Site preparation. The preparation of the surface of a borrow area includes clearing, grubbing, and stripping. The purpose of this effort is to obtain fill material free from such objectionable matter as trees, brush, vegetation, stumps, roots, and organic soil. In marshy areas, a considerable depth of stripping may be required due to frequently occurring 0.9-1.2 m (3-4 ft) root mats, peat, and underlying highly organic soil. Often, marshy areas will not support the construction equipment. All stripped organic material should be wasted in low areas or, where useable as topsoil, stockpiled for later placement on outer dike slopes, berms, exposed borrow slopes, or other areas where vegetative growth is desired.

b. Excavation. Planning for excavation operations in borrow areas should give consideration to the proximity of the areas to the dike, topography, location of groundwater table, possible excavation methods and equipment, and surface drainage.

c. Drainage. Drainage of borrow areas (including control of surface and groundwater) is needed to achieve a satisfactory degree of use. Often, natural drainage is poor, and the only choice is to start at the lowest point and work toward the higher areas, thereby creating a sump. Ditches are often effective in shallow borrow areas. Ditching should be done in advance of the excavation, particularly in fine-grained soils, to allow maximum drying of the soils prior to excavation.

d. Environmental considerations. Permanently exposed borrow areas are usually surface treated to satisfy aesthetic and environmental protection considerations. Generally, projects near heavily populated or industrial areas require more elaborate treatment than those in sparsely populated areas. Minimum treatment should include topographic shaping to achieve adequate drainage, smoothing and blending of the surface, treatment of the surface to promote vegetation growth, and placement of vegetation to conform to the surrounding landscape. Mann et al. (1975) should be consulted for more detailed information concerning landscaping methods.

4.6.6.4 Transportation and placement of materials. Three basic methods for transporting and placing dike materials in the embankment are hauling by means of trucks or scrapers, casting by means of a dragline, and pumping (or hydraulic filling) using a dredge. The relative advantages and disadvantages of these methods are summarized in Table 4-10.

4.6.6.5 Manipulation, compaction, and shaping. After placement, the dike materials may be compacted, semicompacted, or uncompacted. Many variations and combinations of these methods can be and have been used. Classification by these methods does not necessarily refer to the end quality of the embankment; rather, it refers to the amount of control of water content and compactive effort used during construction. The relative advantages and disadvantages of the methods of compaction are summarized in Table 4-11.

4.6.6.6 Construction quality control. The control of quality of construction operations is an extremely important facet of dike operations. Some of the more pertinent items to be inspected during construction of the dike are given in Table 4-12. For further guidance on control of earthwork operations, see EM 1110-2-1911.

Table 4-10. Commonly Used Methods of Transporting Soils in Dike Construction

Method	Advantages	Disadvantages
Hauling	<ul style="list-style-type: none"> <li>- May use central borrow area</li> <li>- Permits use of high-speed, high-capacity equipment</li> <li>- Allows better selection of soil type</li> </ul>	<ul style="list-style-type: none"> <li>- All traveled surfaces must be firm to support equipment</li> <li>- Cannot be used in soft, wet areas or underwater</li> <li>- May require specialized low-pressure equipment</li> </ul>
Casting	<ul style="list-style-type: none"> <li>- Dragline bucket can move very soft, wet soils</li> <li>- Can operate on soft foundation</li> </ul>	<ul style="list-style-type: none"> <li>- Low speed; low capacity</li> <li>- Requires frequent movement of dragline equipment</li> <li>- Short casting distance</li> </ul>
Dredging	<ul style="list-style-type: none"> <li>- Move large quantities of soils from below water</li> <li>- Permits use of dredged materials in dike</li> <li>- May be used on soft foundation and roadway</li> </ul>	<ul style="list-style-type: none"> <li>- Requires dredge and pipeline</li> <li>- Soils cannot be compacted without drying; requires large sections with very flat slopes</li> </ul>

Table 4-11. Commonly Used Methods of Compacting Soils in Dike Construction

Method	Advantages	Disadvantages
Compacted	<ul style="list-style-type: none"> <li>- Placed in thin layers and well compacted, strong dike, low compressibility</li> <li>- Steep slopes, minimum space occupied</li> <li>- Highest quality control</li> </ul>	<ul style="list-style-type: none"> <li>- Requires that soils be dried to water content near plastic limit</li> <li>- Requires competent foundation</li> <li>- Highest cost</li> </ul>
Semicompacted	<ul style="list-style-type: none"> <li>- Uses soils at natural water content, no drying needed</li> <li>- May be used on weaker foundations</li> <li>- Uses thick lifts</li> <li>- May be hauled or cast</li> </ul>	<ul style="list-style-type: none"> <li>- Requires flatter slopes</li> <li>- May be limited in height</li> <li>- Poorer quality control</li> <li>- May require specialized low-pressure equipment</li> </ul>
Uncompacted	<ul style="list-style-type: none"> <li>- Permits use of cast or dredged materials</li> <li>- May be placed on very soft, wet foundation</li> <li>- Fill placed at natural water content</li> <li>- Lowest cost for dike</li> </ul>	<ul style="list-style-type: none"> <li>- Requires very flat slopes</li> <li>- May be severely limited in height or require stage construction</li> <li>- Poorest quality control</li> </ul>

Table 4-12. Operations or Items to be Inspected During Dike Construction

Type Construction	Items or Operation to Be Checked
Compacted	<ul style="list-style-type: none"> <li>Proper fill material</li> <li>Loose lift thickness</li> <li>Disking</li> <li>Water content</li> <li>Type of compaction equipment and number of passes</li> <li>Density</li> </ul>
Semicompacted	<ul style="list-style-type: none"> <li>Proper fill material</li> <li>Loose lift thickness</li> <li>Water content (if required)</li> <li>Number of passes (if required)</li> <li>Routing of hauling and spreading equipment</li> </ul>
Uncompacted	<ul style="list-style-type: none"> <li>Proper fill material (displacement technique)</li> <li>Dumping and shoving techniques</li> <li>Ensuring fill is advanced in V-shape and with slopes as steep as possible</li> <li>Elevation of fill surface</li> <li>Prevention of rutting of fill surface by hauling equipment</li> </ul>

#### 4.6.7 Miscellaneous features.

4.6.7.1 Discharge facilities. Both excessive uniform and differential settlement of the dike can cause distortion and/or rupture of weir discharge pipes located under or through dikes (Figure 4-59) and can cause distortion of the weir box itself (Figure 4-60). The settlement effect

can be somewhat mitigated by cambering (Figure 4-61) or raising one end (Figure 4-62) of the pipe during construction.

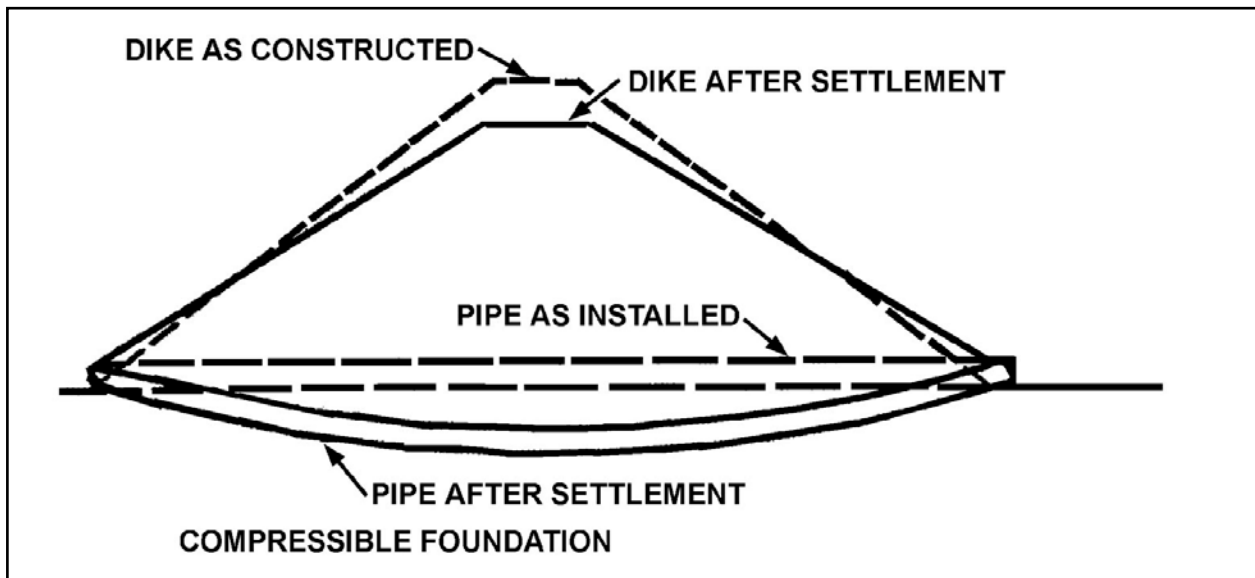

Figure 4-59. Swagging of a Pipe due to Settlement of the Dike Foundation

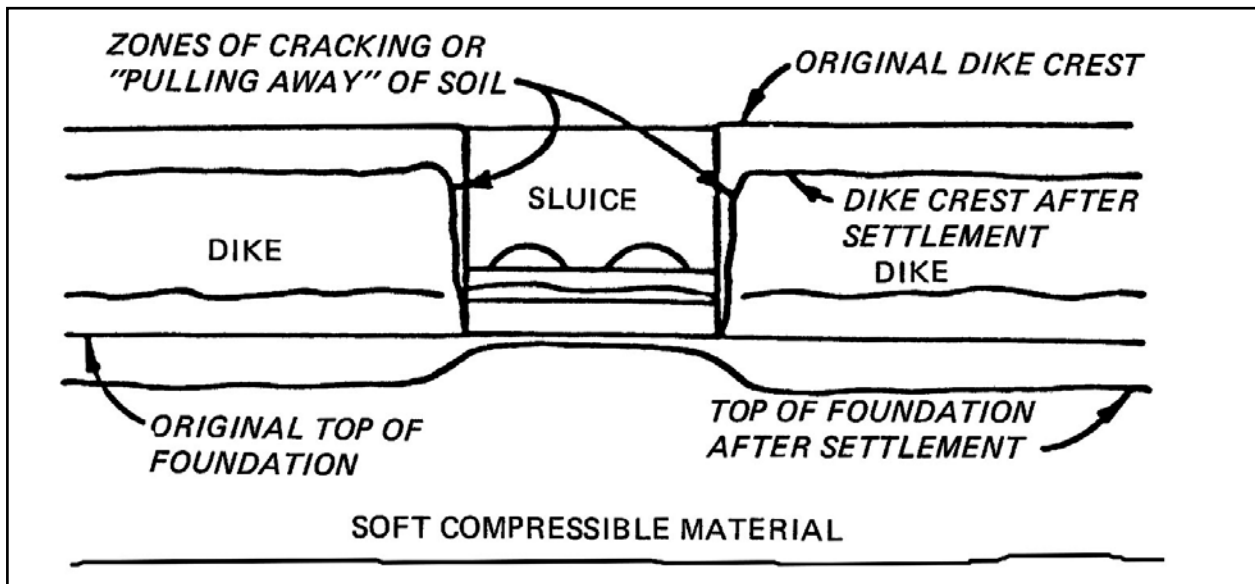

Figure 4-60. Cracking at the Dike-Structure Junction Caused by Differential Settlement Because the Dike Load is much Greater than the Weir Load

31 Jul 15

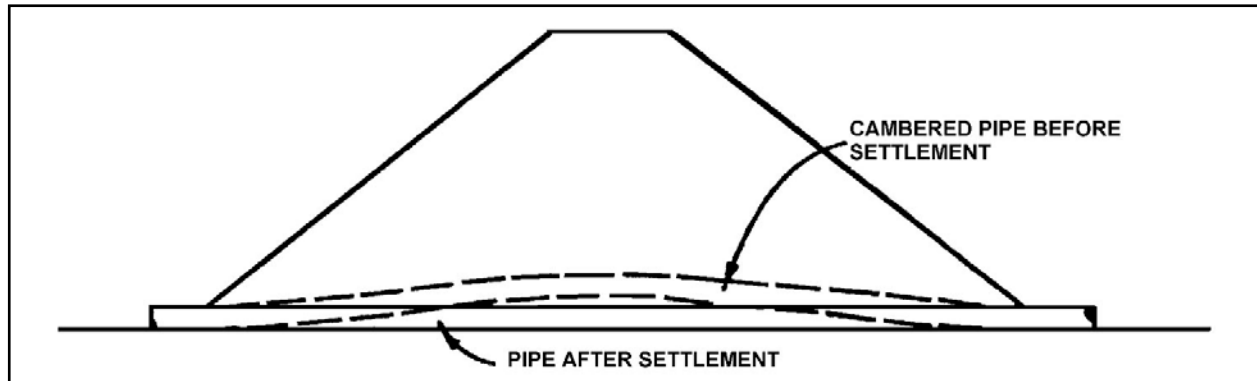

Figure 4-61. Cambered Pipe Beneath a Dike

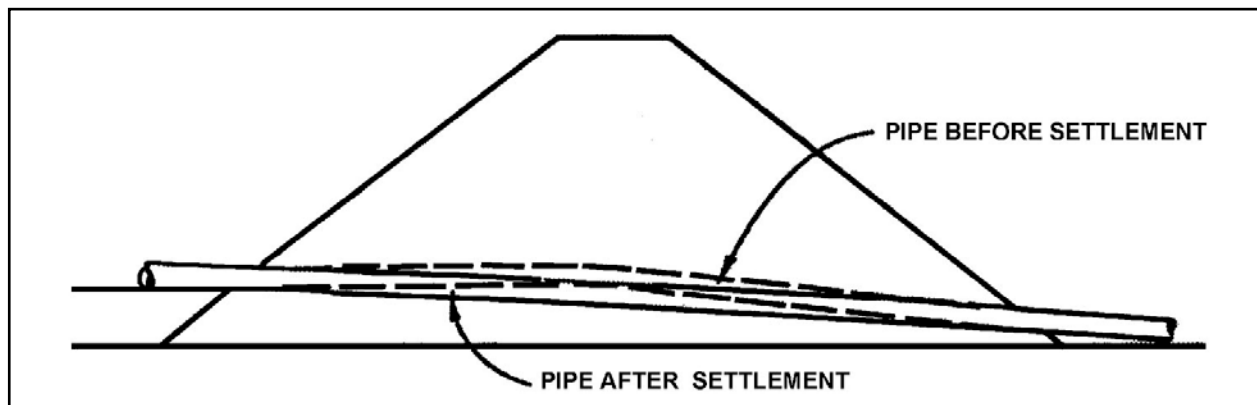

Figure 4-62. Cambered and Raised Pipe Beneath a Dike

4.6.7.2 Seepage control. Anti-seepage devices, either metal fins or concrete collars, have been used in the past to inhibit seepage and piping along the outside wall of the outlet pipe. These have not proven effective. To aid in the prevention of piping failures along the pipe-soil interface, a 46 cm (18 in.)-minimum annular thickness of drain material (clean pervious sand or sand/gravel) should be provided around the outlet one-third of the pipe, as shown in Figure 4-63. This may be omitted where the outlet one-third of the pipe is located in sand.

4.6.7.3 Additional uses of geotextiles. The use of geotextiles to provide soil reinforcement was presented in paragraph 4.6.4.8. In addition, geotextiles have been extensively used as filter fabrics to replace the filter materials, drain materials, a separation medium, and an armor medium to inhibit erosion. A brief summary of geotextile functions in dike construction is given in Table 4-13.



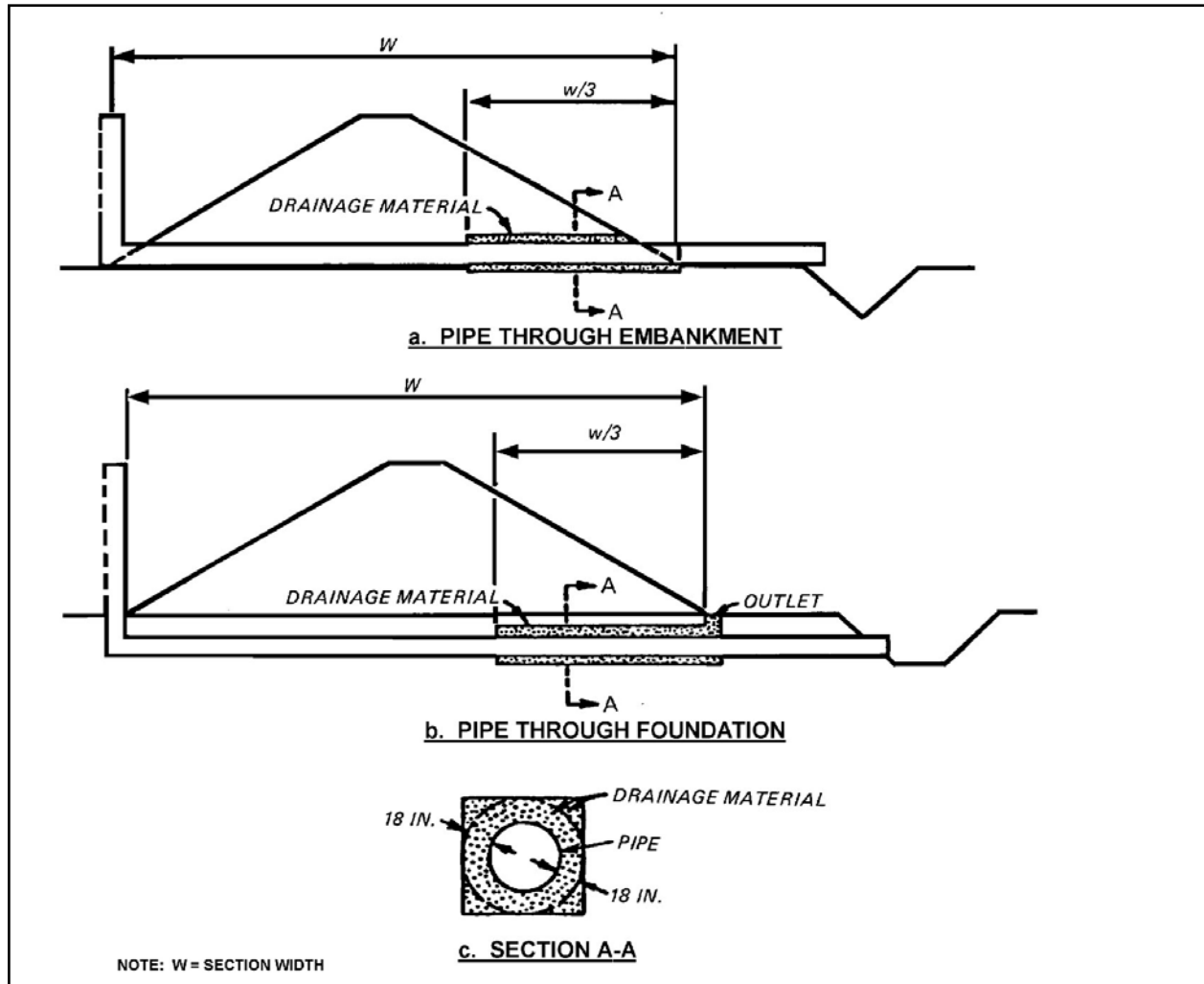

Figure 4-63. Annular Drainage Material Around the Outlet One-Third of a Pipe

Table 4-13. Description of Geotextile Functions

Function	Description
Filter	- The process of allowing water to escape easily from a soil unit while retaining the soil in place. The water is carried away by some other drain (for example, rock or rock with a pipe).
Drain	- The situation where the fabric itself is to carry the water away from the soil to be drained. The process of preventing two dissimilar materials from mixing.
Separation	- This is distinct from the filtration function in that it is not necessary for water to pass through the fabric.
Reinforcement	- The process of adding mechanical strength to the soil-fabric system.
Armor	- The process of protecting the soil from surface erosion by some tractive force. Usually in these situations, the fabric serves only for a limited time.

31 Jul 15

#### 4.7 Contaminant Pathway Analysis.

4.7.1 General. Placement of dredged material in CDFs is the most commonly considered alternative for materials found to be unsuitable for conventional open-water placement. For this reason, consideration of pathways for migration of contaminants from the CDFs is often required. Screening procedures and specific laboratory test procedures have been developed to evaluate CDF contaminant pathways. Some of these procedures and tests have been field verified and are now in general use while others are newly developed, and field verification is either underway or planned. This section of the EM describes the pathways and geochemical environments associated with CDFs and briefly describes the procedures for testing and evaluation of the pathways. The USACE has developed a separate Upland Testing Manual (UTM) intended for regulatory application (USACE 2003). The manual contains the detailed testing procedures and protocols for CDFs, and these detailed testing procedures are, therefore, not repeated in this EM.

##### 4.7.2 Description of CDF contaminant pathways.

4.7.2.1 Upland. The possible migration pathways of contaminants from confined placement facilities in the upland environment are illustrated in Figure 4-64. These pathways include effluent discharges to surface water during filling operations and subsequent settling and during dewatering, rainfall surface runoff, leachate into groundwater, volatilization to the atmosphere, and direct uptake. Direct uptake includes plant uptake and subsequent cycling through food webs and direct uptake by animal populations living in close association with the dredged material. Effects on surface water quality, groundwater quality, air quality, plants, and animals depend on the characteristics of the dredged material, management and operation of the site during and after filling, and the proximity of the CDF to potential receptors of the contaminants. A number of control measures are available to minimize impacts of losses by these pathways. A technical framework (USEPA/USACE 2004; Francingues et al. 1985) has been developed that identifies standardized testing procedures for dredged materials to determine appropriate placement controls.

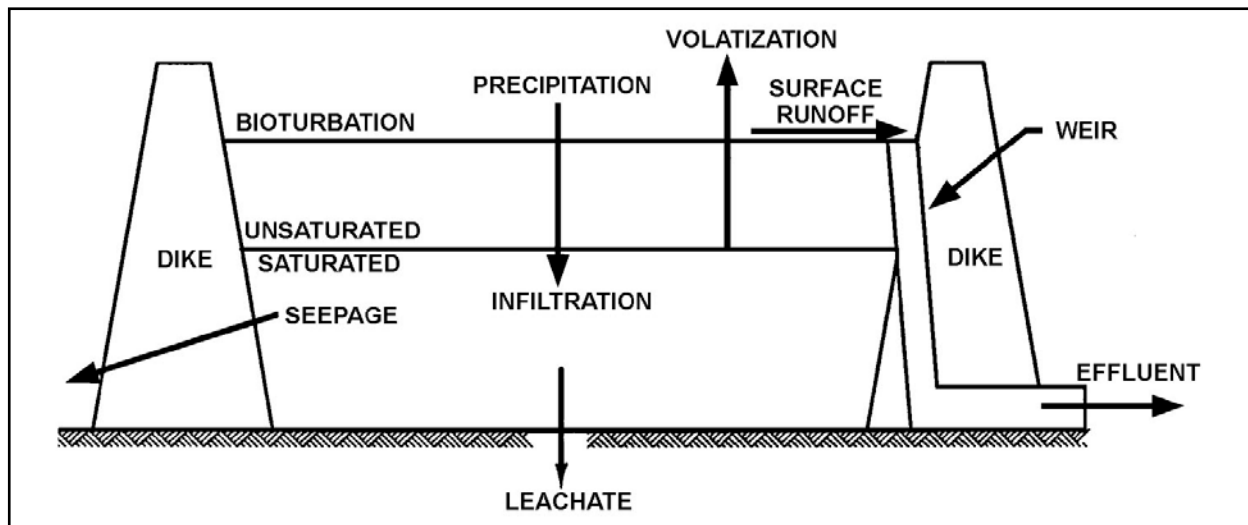

Figure 4-64. Contaminant Pathways from Upland CDFs

## 4.7.2.2 Nearshore.

a. Migration pathways affected by nearshore CDFs, illustrated in Figure 4-65, include a number of the pathways that are considered for upland CDFs. However, the relative importance of contaminant migration pathways for a nearshore CDF differs from an upland CDF. A primary advantage of the nearshore CDF is that the contaminated dredged material remains within the saturated zone so that anaerobic conditions prevail and contaminant mobility is minimized. A disadvantage is that water level fluctuation via tidal pumping or other mechanisms causes a pumping action through the exterior berms, which are generally constructed of permeable material. Groundwater gradients through the contaminated sediment in a marine nearshore CDF are also minimized due to the fact that fresh water, being less dense than salt water, tends to move above the saltwater wedge; minimizing contact with the contaminated dredged material (Riley et al. 1994). Groundwater flow is also directed upward by the reduced hydraulic conductivity of the contaminated sediments compared to berm and capping materials. That portion of a nearshore CDF raised to above the mean high-water elevation essentially functions as an upland CDF. Additional considerations for nearshore sites (with one or more sides within the influence of water-level fluctuations) are soluble convection through the dike in the partially saturated zone and soluble diffusion from the saturated zone through the dike. Pathways for island CDFs are similar to intertidal sites.

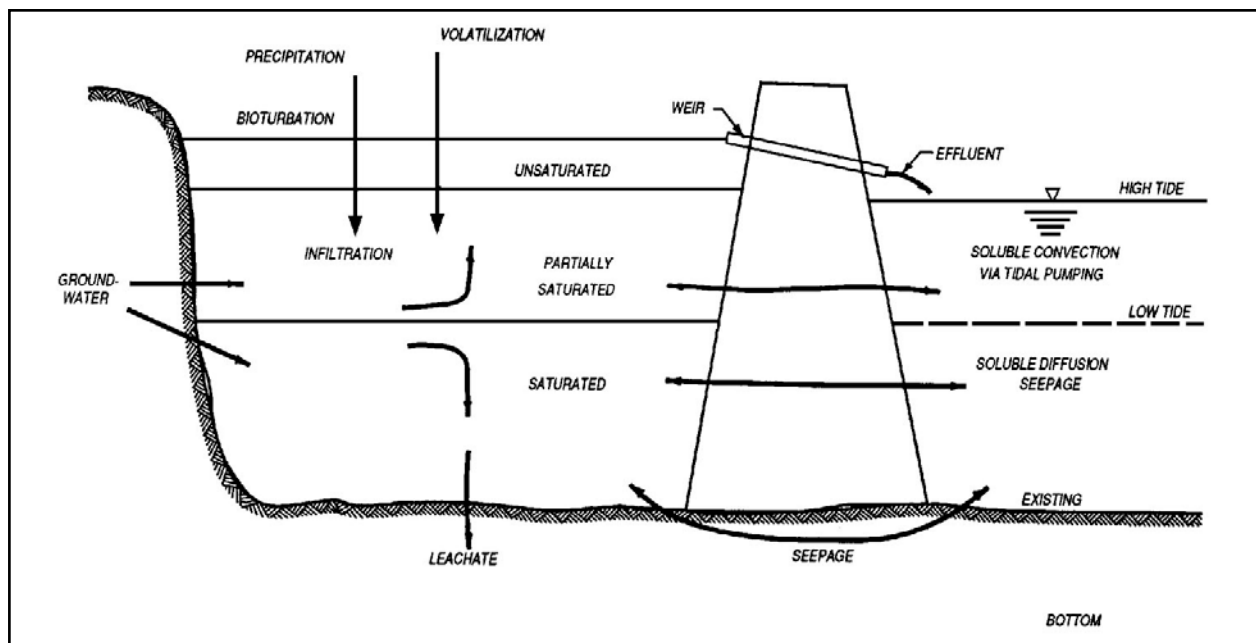

Figure 4-65. Contaminant Pathways from Nearshore CDFs

b. Analysis of CDF pathways for nearshore sites includes several of the same tests used for upland sites. Procedures used to estimate the additional potential fluxes for the in-water CDF have been used in a number of in-water CDF evaluations (Francingues, Averett, and Otis 1988; Shields, Schroeder, and Palermo 1989). A number of these protocols have been used in Puget Sound projects, such as Southwest Harbor, Everett, and Milwaukee Waterway. One key difference is the analysis of the leachate pathway. Procedures tailored to the anaerobic environment are

applicable to the dredged material layer that remains saturated in the nearshore environment. Ponded conditions that normally exist in nearshore or in-water CDFs can limit concerns with the volatilization pathway. The surface runoff is of concern only if the dredged material fill is raised above the mean high water elevation. Ideally, clean material would be placed above MHHW. One pathway of concern is the plant and animal pathway. Benthic in fauna will likely colonize in the material placed inside the CDF. While the entrance notch is open, fish and other aquatic life may pass in and out of the site picking up contaminants in their food chain. To minimize this potential, a moveable barrier, such as a silt curtain or wire mesh, could remain in place except when a barge is entering and exiting the CDF. A more elaborate system, similar to a navigation lock, would add significantly to the cost of the site. The USEPA/USACE Technical Framework, the Comprehensive Analysis of Migration Pathways (CAMP) (Myers 1990), and the Upland Testing Manual (USACE 2003) describe appropriate testing and evaluation procedures.

4.7.2.3 CDF geochemical environments. The CDF contaminant pathways of potential concern and the potential for contaminant migration along those pathways are dependent on the geochemical environment existing in the CDF at any time of interest. The geochemical environments associated with a CDF include the upland, intertidal, and aquatic environments. Materials initially placed in CDFs built in water are in an aquatic environment. As the fill elevation rises to the intertidal level and above, the material will be in an intertidal or upland geochemical environment.

#### 4.7.2.4 Upland geochemical environment.

a. When dredged material is placed in an upland environment, physical and/or chemical changes may occur (Francingues et al. 1985). Initially, the dredged material is dark in color and reduced, with little oxygen. If the material is hydraulically placed in the CDF, the ponded water usually becomes oxygenated. This may affect the release of contaminants in effluent discharged during hydraulic filling. For example, metals may become more readily released from suspended solids to the dissolved phase by oxygenated conditions in a CDF pond.

b. Once placement operations are completed, and any ponded water has been removed from the surface of the CDF, the exposed dredged material becomes oxidized and lighter in color. The dredged material may begin to crack as it dries out. Accumulation of salts develops on the surface of the dredged material, and especially on the edge of the cracks, but rainfall events tend to dissolve and remove these salt accumulations in surface runoff. Certain metal contaminants may also become dissolved in surface runoff.

c. During the drying process, organic complexes become oxidized and decompose. Sulfide compounds also become oxidized to sulfate salts, and the pH may drop drastically. These chemical transformations can release complex contaminants to surface runoff, soil pore water, and leachate. In addition, plants and animals that colonize the upland site may take up and bioaccumulate these released contaminants.

d. Volatilization of contaminants depends on the types of contaminants present in the dredged material and the mass transfer rates of the contaminants from sediment to air, water to air, and sediment to water. Release of the dredged material slurry above the water level in the CDF

surface enhances volatilization as the slurry impacts the CDF surface, creating turbulence and releasing dissolved gases. The transfer rate from water to air for organics such as polychlorinated biphenyls (PCBs) is generally slower than from sediment to air (Thibodeaux 1989). Therefore, the inundated dredged material prior to dewatering is less likely to produce volatiles than is the sediment as it dewateres and dries.

#### 4.7.2.5 Nearshore geochemical environment.

a. CDFs constructed totally or partially in water usually receive dredged material until the final elevation is above the high-water elevation. Three distinct physicochemical environments may eventually exist at such a site: upland (dry unsaturated layer), intermediate (partially or intermittently saturated layer), and aquatic (totally saturated layer) (USEPA/USACE 2004).

b. When material is initially placed in an in-water CDF, the CDF is completely flooded or saturated throughout the vertical profile. The saturated condition is anaerobic and reduced, which favors immobility of organic and heavy metal contaminants. Maintaining conditions in the saturated zone of the CDF similar to those at the site of dredging takes advantage of the relatively stable geochemical conditions for fine-grain sediments and contaminants. Most contaminants remain tightly sorbed to the sediment fines and organic matter.

c. After the site is filled and dredging ceases, the dredged material above the high-water level begins to dewater and consolidate through movement of water upward and out of the site as surface drainage or runoff and laterally as seepage through the dike. At this point, the surface layer has characteristics similar to those of material in an upland CDF. As the material desiccates through evapotranspiration, it becomes aerobic and oxidized, conditions favorable for mobilization of heavy metals.

d. The bottom of an in-water CDF below the low-tide or groundwater elevation remains saturated and anaerobic, favoring insolubility and contaminant attraction to particulate matter. After dewatering of the dredged material above the flooded zone ceases and consolidation of the material in the flooded zone reaches its final state, water movement through the flooded material is minimal, and the potential for migration of contaminants is low.

e. The intermediate layer between the saturated and unsaturated layers are a transition zone and may alternately be saturated and unsaturated as the water surface fluctuates. The depth of this zone and the volume of dredged material affected depend on the difference in tide elevations and on the permeability of the dike and the dredged material.

#### 4.7.3 Pathway screening procedures.

4.7.3.1 An initial evaluation of sediment contamination should be conducted to determine if contaminants are of concern for specific pathways; however, methods for initial evaluation or screening are not fully developed. At present, the initial evaluation should be based on previous experience with pathway testing and consideration of the level of contamination present in the sediments.

4.7.3.2 An analysis of CDF pathways of concern must be conducted to determine if testing is warranted. Brannon et al. (1990) identified key contaminant mobility processes and pathways and, where possible, methods for estimation of contaminant mass exit rates for CDFs. Pathways involving movement of large masses of water, such as CDF effluent discharge, have the greatest potential for moving significant quantities of contaminants out of CDFs. Pathways such as volatilization may also result in movement of volatile organic chemicals in highly contaminated dredged sediments at certain stages in the filling of a CDF. The relative importance of contaminant cycling and mobilization of contaminants to net mass balance in a CDF has not been determined.

4.7.3.3 The USACE has developed guidelines and a framework for the Comprehensive Analysis of Migration Pathways (CAMP) for contaminated dredged material placed in CDFs (Myers 1990). CAMP has been developed as an internally consistent set of procedures for comparing the containment efficiency of CDF placement alternatives and, as such, for providing supporting documentation for evaluating alternatives. The framework for analysis in CAMP is a tiered assessment and, as such, can be used to identify those CDF pathways that warrant more detailed assessment based on specific laboratory tests. However, CAMP is intended to interact with, but is not a substitute for, the existing effects-based dredged material test procedures presently used (USEPA/USACE 2004; USACE 2003).

4.7.3.4 More definitive screening procedures for CDF pathways will be developed under the Dredging Operations and Environmental Research Program (DOER) program.

4.7.3.5 If the initial evaluation of sediment contamination determines that contaminants are not of concern for specific pathways, then no contaminant testing is required for those pathways. However, if contaminants are of concern, an analysis of appropriate pathways must be conducted that may include possible testing.

#### 4.7.4 Effluent quality analysis.

4.7.4.1 The effluent from a CDF may contain both dissolved and particulate-associated contaminants. A large portion of the total contaminant concentration is tightly bound to the particulates. Effluent from a CDF (return flow to waters of the United States) is considered a dredged material discharge under Section 404 of the CWA and is also subject to water quality certification under Section 401 State standards.

4.7.4.2 Prediction of effluent quality should be made using a modified elutriate test procedure (Palermo 1985; Palermo and Thackston 1988) that simulates the geochemical and physical processes occurring during confined placement. A photo of a modified elutriate test in progress is shown in Figure 4-66. This test provides information on the dissolved and particulate contaminant concentrations. The column settling test (Appendix H, "Column Settling Test Procedures") used for CDF design provides the effluent solids concentrations. Results of both tests can be used to predict a total concentration of contaminants in the effluent. The predicted effluent quality, with allowance for any mixing zone, can be compared directly with water quality standards. Computer programs are also available for data reduction and analysis (Palermo and Schroeder 1991).



Figure 4-66. Modified Elutriate Test in Progress

4.7.4.3 The modified elutriate test can also be used to develop the water medium for bioassays if a biological approach to evaluation of effluent quality is needed. These bioassays are conducted in a manner similar to that for open-water disposal. The quality of a reference water (usually the receiving water) should be considered in test interpretation.

4.7.4.4 If effluent contaminant concentrations exceed standards, appropriate controls should be considered. Control measures available for effluent discharge include improved settling design or reduced flow to the containment area, chemical clarification or filtration to remove particulate contaminants, and removal or destruction of dissolved contaminants by more sophisticated treatment processes (paragraph 4.8).

#### 4.7.5 Surface runoff quality analysis.

4.7.5.1 Immediately after material placement in a CDF and after ponding water is decanted, the settled material may experience surface runoff. Rainfall during this initial period will likely be erosive, and runoff will contain elevated solids concentrations. Geochemically speaking, the contaminant release is controlled by anaerobic conditions. Once the surface is allowed to dry, the runoff will contain a lesser concentration of solids, but the release is now controlled by aerobic

31 Jul 15

conditions, and release of some dissolved contaminants may be elevated. Runoff water quality requirements may be a condition of the water quality certification or may be considered as part of the NEPA process.

4.7.5.2 Presently, there is no simplified procedure for prediction of runoff quality, but simplified procedures are being developed the Long-Term Effect of Dredging Operations (LEDO) Program. A soil lysimeter testing protocol (Lee and Skogerboe 1983) has been used to predict surface runoff quality with good results (see Figure 4-67). The lysimeter is equipped with a rainfall simulator and can be used in the laboratory or transported to the field site. Computer programs are also available for data reduction and analysis (Brandon, Schroeder, and Lee 1997).



Figure 4-67. Soil Lysimeter

4.7.5.3 If runoff concentrations exceed standards, appropriate controls may include placement of a surface cover or cap on the site, maintenance of ponded water conditions (although this may conflict with other management goals), vegetation to stabilize the surface, treatments such as liming to raise pH, or treatment of the runoff as for effluent (Skogerboe and Lee 1987).

#### 4.7.6 Leachate quality analysis.

4.7.6.1 Subsurface drainage from upland CDFs may reach adjacent aquifers or may enter surface waters. Fine-grained dredged material tends to form its own placement-area liner as particles settle with percolation of water, but consolidation may require some time for this to occur. Since most contaminants potentially present in dredged material are closely adsorbed to particles, the dissolved fraction present in leachates is usually small relative to the total contaminant mass present in the dredged material.



4.7.6.2 Evaluation of the leachate quality from a CDF must include a prediction of which contaminants may be released in leachate and the relative degree of release or mass of contaminants. Procedures are available for prediction of leachate quality which have been developed specifically for application to dredged material placement sites (Myers and Brannon 1991; Myers, Gambrell, and Tittlebaum 1991; Brannon, Myers, and Tardy 1994; and Myers 1996). These procedures are based on theoretical analysis and include laboratory batch and column testing. A batch leaching test in progress is shown in Figure 4-68.

4.7.6.3 The testing procedures give data only on leachate quality. Estimates of leachate quantity must be made by considering site-specific characteristics and groundwater hydrology. Computerized procedures, such as the USEPA Hydrologic Evaluation of Landfill Performance model (Schroeder and Ammon 1984) have also been used to estimate water balance (budget) for dredged material CDFs (Palermo and Randall 1989; Francingues, Averett, and Otis 1988; Aziz, Schroeder, and Myers 1994).

4.7.6.4 If leachate concentrations exceed applicable criteria, controls for leachate must be considered. These may include proper site specification to minimize potential movement of water into aquifers, dewatering to reduce leachate generation, chemical modifications to retard or immobilize contaminants, physical barriers such as clay and synthetic liners, capping/vegetating the surface to reduce leachate production, and collection and treatment of the leachate.

#### 4.7.7 Plant and animal uptake.

4.7.7.1 Some contaminants can be bioaccumulated in plant tissue and become further available to the food chain. If the contaminants are identified in the dredged material at levels that cause a concern, then prediction of uptake is based on a plant or animal bioassay (Folsom and Lee 1985; Simmers, Rhett, and Lee 1986; Stafford, Simmers, and Rhett 1987). Plant and animal uptake tests are shown in Figure 4-69 and Figure 4-70. Appropriate plant or animal species are grown in either a flooded or dry soil condition using the appropriate experimental procedure and laboratory or field test apparatus. Contaminant uptake is then measured by chemical analysis of the biomass (tissue). Growth, phytotoxicity, and bioaccumulation of contaminants are monitored during the growth period in the case of the plant bioassay. An index species is also grown to serve as a mechanism to extrapolate the results to allow use of other databases, such as metals uptake by agricultural food crops. This indexing procedure provides information upon which a decision can be made regarding potential for human health effects and for beneficial uses of the site or dredged material. Levels of contaminants in the biomass are compared with Federal criteria for food or forage.

4.7.7.2 From the test results, appropriate management strategies can be formulated regarding where to place dredged material to minimize plant or animal uptake or how to control and manage the species on the site so that desirable species that do not take up and accumulate contaminants are allowed to colonize the site while undesirable species are removed or eliminated.

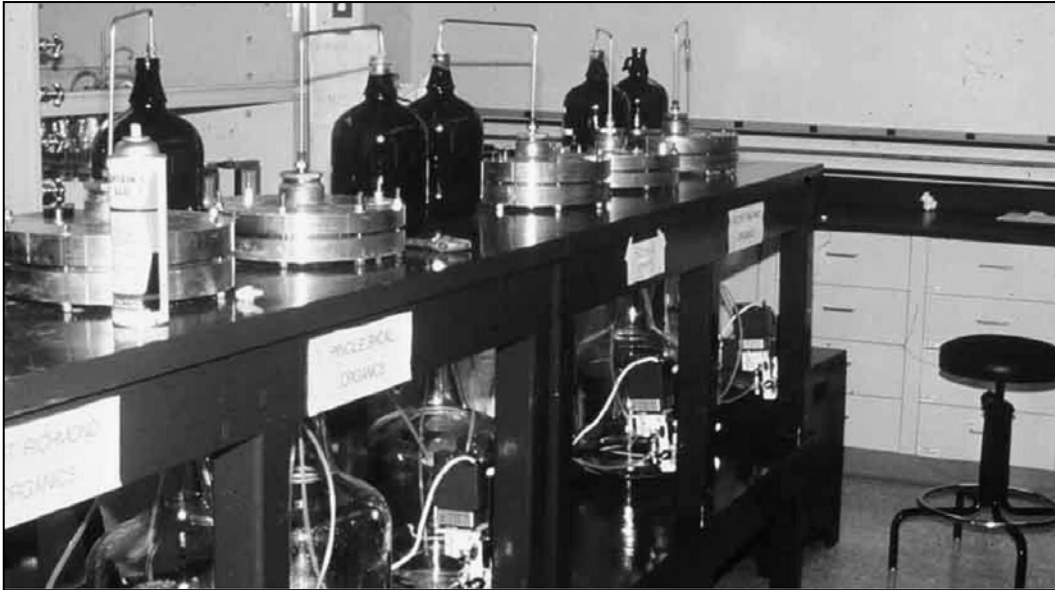

Figure 4-68. Batch Leaching Test



Figure 4-69. Plant Uptake

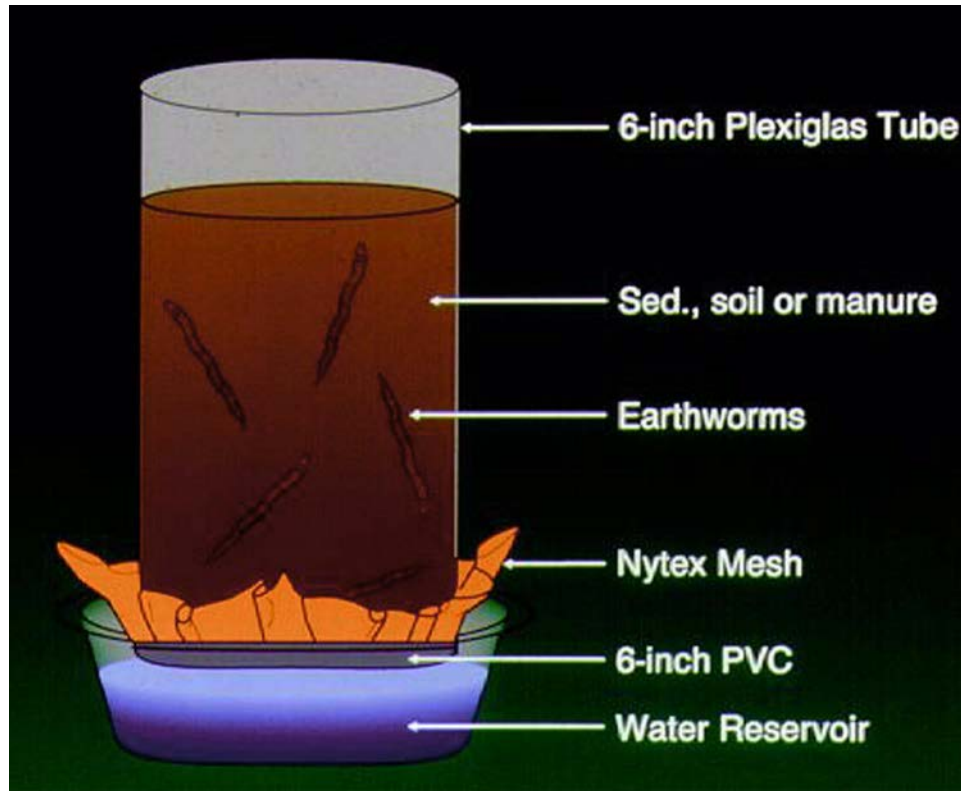

Figure 4-70. Animal Uptake

#### 4.7.8 Volatilization analysis.

4.7.8.1 Contaminant transport from in situ sediment to air is a relatively slow process because most contaminants must first be released to the water phase prior to reaching the air. Potential for volatilization should be evaluated in accordance with regulatory requirements of the Clean Air Act. Thibodeaux (1989) discusses volatilization of organic chemicals during dredging and placement and identifies four locales where volatilization may occur (volatilization is favored in the order of conditions listed):

- a. Dredged material exposed directly to air.
- b. Dredging site or other water area where suspended solids are elevated.
- c. Poned CDF with a quiescent, low suspended solids concentration.
- d. Dredged material covered with vegetation.

4.7.8.2 In cases where highly contaminated sediments are disposed, airborne emissions must be considered to protect workers and others who could inhale contaminants released through this pathway.

31 Jul 15

4.7.8.3 Rate equations based on chemical vapor equilibrium concepts and transport phenomena fundamentals have been used to predict chemical flux (Thibodeaux 1989; Semmler 1990). First-generation laboratory tests for prediction of volatile losses have also been developed (Price, Brannon, and Myers 1997, Price, Brannon, and Yost 1999). Emission rates are primarily dependent on the chemical concentration at the source, the surface area of the source, and the degree to which the dredged material is in direct contact with the air. A schematic of the volatile test chamber is shown in Figure 4-71.

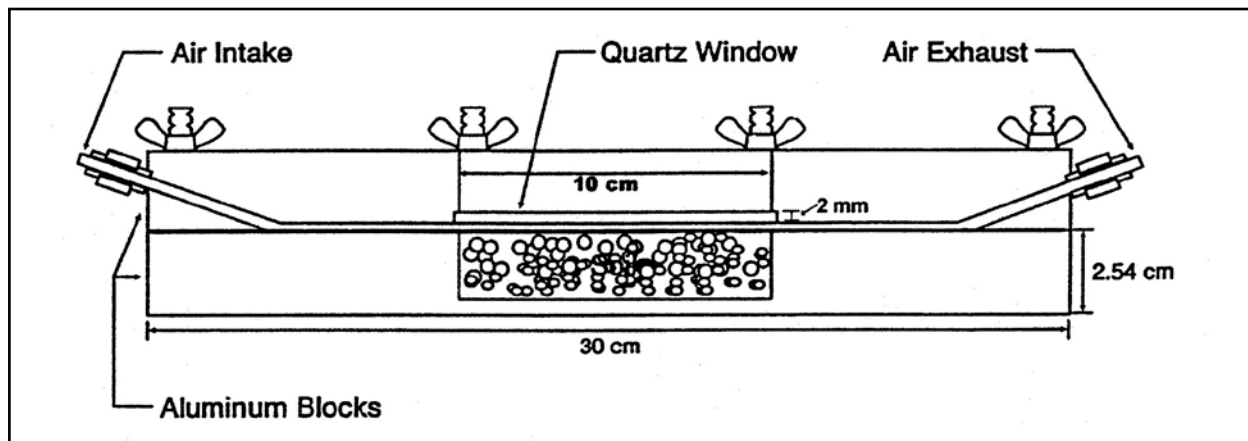

Figure 4-71. Schematic of Volatile Test Chamber

#### 4.8 Control and Treatment of Effluent and Other Discharges.

4.8.1 General. If the CDF cannot be sized to provide sufficient clarification of effluent to meet applicable suspended solids/turbidity standards, control and treatment measures can be considered. Since a large portion of the total concentration of contaminants in effluents is associated with the suspended solids, reduction in the suspended solids also serves to control contaminant releases. Suspended solids removal, therefore, offers the greatest benefits in improving effluent quality, not only by reducing turbidity, but also by removing particulate-associated contaminants.

4.8.2 Treatment and control for TSS/turbidity. Suspended solids removal processes differ from dewatering processes because for this application the solids concentration is much lower than for a dredged material slurry. Settling mechanisms for these streams are characterized by flocculant settling rather than by zone or compression settling. For CDF liquid streams, the solids remaining will be clay- or colloidal-size material that may require flocculants to promote further settling in clarifiers or sedimentation ponds. Chemical clarification using organic polyelectrolytes is a proven technology for CDF effluents (Schroeder 1983). Filtration, permeable dikes, sand-filled weirs, and wetlands have also been used on occasion for CDF demonstrations or pilot evaluations. Descriptions of suspended solids removal processes as applied to CDFs presented here are summarized from the literature (Cullinane et al. 1986; Averett, Perry, and Miller 1990; USEPA 1994).

#### 4.8.2.1 Granular media filtration.

a. Filtration of CDF effluents with granular media has been applied extensively at CDFs in the Great Lakes region. Granular media filtration is a process that uses a bed of granular material to treat water or wastewater. Filtration is the most commonly used technology for treatment of drinking water. Granular media for filtration include fine gravel, sand, anthracite, and coal. Systems may function using gravity drainage through filter media, with pumps, or under pressure. A granular media filtration unit at the Chicago CDF is shown in Figure 4-72. Typical cross sections of dike sections are shown in Figure 4-73.

b. In many wastewater treatment applications, filtration is the final step of a treatment system (sometimes called polishing). All filters eventually clog, and, in most cases, water should be pretreated by settling, chemical clarification, or other methods to reduce suspended solids before filtration. Granular media filtration may be applied to water drained from contaminated sediments in a number of ways. These include permeable filter dikes or weirs, filter cells, and “package” filter systems.

c. Most of the in-water CDFs and some of the upland CDFs around the Great Lakes have been constructed with permeable dikes. Many in-water CDFs have a core of granular material (gravel, sand, or combinations). Upland CDFs have been constructed with a section of the dike formed of granular material. As water moves horizontally through the dikes, suspended solids are removed by the filter media. The effluent suspended solids content is dependent on the particle size and thickness of the filter media and the suspended solids levels of influent.



Figure 4-72. Granular Media Filtration



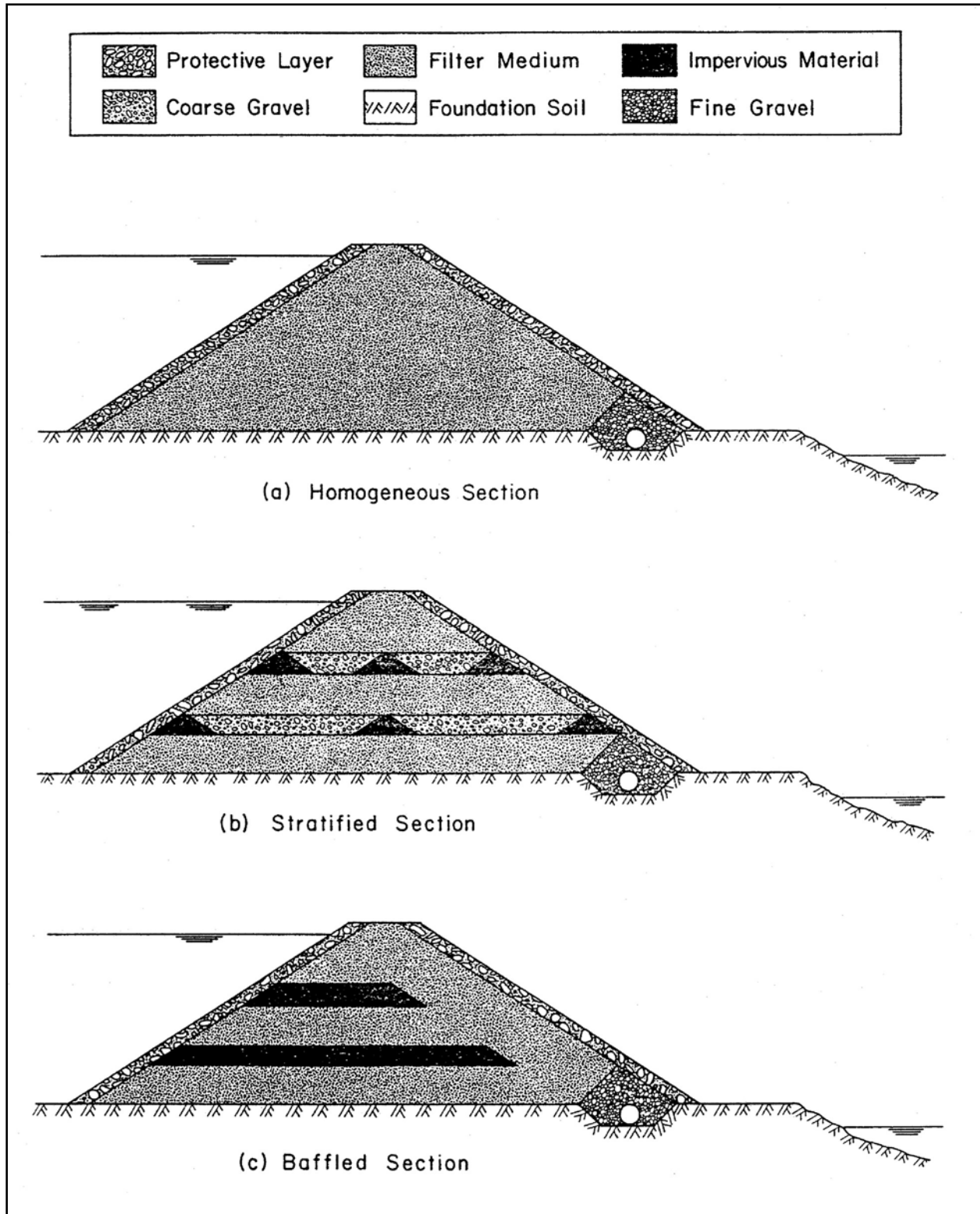

Figure 4-73. Cross Sections of Dike Sections

d. Permeable treatment beds have been tested at bench and pilot scales to provide the preliminary quantification of their effectiveness. Laboratory tests indicate that permeable treatment beds may be practical for removing suspended solids from effluent when solids concentrations are as high as 1 g/L for periods of approximately 1 year before clogging (Krizek, Fitzpatrick, and Atmatzidis 1976). Filter dikes will become clogged as sediment particles are trapped by the filter media. Proper management of a placement facility is required to ensure that the filter dikes are not overloaded, causing them to clog prematurely.

e. Filter cells, or sand-filled weirs, provide filtration in a vertical gravity flow mode and may be more flexible than permeable filter dikes/beds, allowing easier replacement and maintenance. They consist of several cylindrical or rectangular cells containing the filter medium. The filter medium depth is obtained at the deepest level possible to provide for better solids retention. The filter medium used is typically sand with a particle size of approximately 1 mm (0.04 in). Excessive maintenance is required if the influent contains more than 1 g/L suspended solids (Krizek, Fitzpatrick, and Atmatzidis 1976). Sand-filled weirs can remove 60-98% of the suspended solids and sediment-bound contaminants from wastewater. Typically, the effluent suspended solids concentration is reduced to 5 to 10 mg/L (Cullinane et al. 1986).

f. Filter cells constructed with steel-sheet piles, using sand filter media, have been used at a number of in-water CDFs on the Great Lakes. Concrete filter cells with sand and carbon filter media have been used at CDFs in Chicago with suspended solids removal efficiencies of up to 90%. Depending on the design of the filter, the nature of the dredged material, and the loading rate, a filter cell can effectively remove most of the suspended solids from the effluent from several dredging operations before it becomes clogged (Barnard and Hand 1978).

g. Portable wastewater treatment systems, including granular media filtration, are commercially available. These “package” systems may be mounted on a trailer bed or installed onsite. Most of them are intended for small flow rates, but they can be run in parallel or in series, if necessary. To prevent clogging of the filter media, water is backflushed through the filter at a high velocity to remove solids that have become lodged within the filter media pores. This backwash water requires further treatment since it contains high concentrations of solids (De Renzo 1978).

h. Design procedures for sand filtration systems for solids removal (Krizek, Fitzpatrick, and Atmatzidis 1976) are available. Additional efforts to evaluate the contaminant removal efficiencies of filtration systems and design of the systems for contaminant removal are planned under the DOER Program.

#### 4.8.2.2 Chemical clarification.

a. Chemical clarification is defined as the use of coagulants or flocculants to promote settling of the smaller colloidal-size particles in dredged material. These particles settle very slowly and often have high contaminant concentrations compared to the bulk sediment. Coagulation causes these particles to agglomerate into larger particles with sufficient size and density to settle more rapidly (Jones, Williams, and Moore 1978).

31 Jul 15

b. Coagulants include inorganic chemicals, such as the salts of iron and aluminum, which are widely used in the water treatment industry, and organic polyelectrolytes. Wang and Chen (1977) evaluated inorganic and organic coagulants for application to dredged material and recommended organic polyelectrolytes for dredging operations because they are less dependent on pH and require lower dosages than do inorganic coagulants.

c. Chemical clarification is efficient for treating effluent from a settling process. Treatment of dredged material slurry was demonstrated in pilot studies by Jones, Williams, and Moore (1978) and by Schroeder (1983). Simple processes of mixing concentrated polyelectrolyte and water and using a pump to meter the solution into a port in the pipeline are readily available. Turbulence in the pipeline provides energy and mixing for the polyelectrolyte and solids. A settling process must follow to complete the chemical clarification process. Large polymer loadings can achieve near 100% reduction in turbidity and suspended solids in the slurry based on small column tests of treated pipeline slurry. Chemical clarification can be highly efficient, but full-scale field conditions would likely result in a lower efficiency because of inefficiencies of the settling process.

d. Evaluation of chemical clarification as an option for treatment and control of effluent suspended solids requires jar tests for screening coagulants and determining optimum dosages and design of the clarification system for the CDF. The procedures described here were taken from Schroeder (1983). Additional efforts to evaluate the contaminant removal efficiencies of filtration systems and design of the systems for contaminant removal are planned under the DOER Program.

4.8.2.3 Chemical clarification (jar) testing. Jar tests have traditionally been used to evaluate the effectiveness of various flocculants under a variety of operating conditions for water treatment, and these procedures have been applied to the placement of dredged material. Jar tests are used to provide information on the most effective flocculant, optimum dosage, optimum feed concentration, effects of dosage on removal efficiencies, effects of concentration of influent suspension on removal efficiencies, effects of mixing conditions, and effects of settling time. Detailed jar test procedures are found in Appendix K, "Jar Test Procedures for Chemical Clarification."

4.8.2.4 Design of chemical clarification systems. Pipeline injections of chemicals for clarification into the dredge inflow pipeline have shown only limited effectiveness and require much higher dosages of chemicals. Chemical clarification of primary containment area effluents is the recommended approach, with the system designed for injection of the chemical at the effluent discharge weir from a primary basin. The design is composed of three subsystems: the polymer feed system including storage, dilution, and injection; the weir and discharge culvert for mixing; and the secondary basin for settling and storage. The treatment system should be designed to minimize equipment needs and to simplify operation. Detailed procedures and examples are presented in Appendix M, "Procedures and Example Calculations for Design of a Chemical Clarification System."



### 4.8.3 Discharge treatment for contaminant removal.

#### 4.8.3.1 General.

a. The objective of liquid streams controls is to remove residual contaminants from the liquids produced as discharges from a CDF operation, such as effluent discharges from active filling operations, surface runoff, leachate, and waters from dewatering or treatment processes. Contaminants in these streams present a wide array of concentrations, depending on their source, and individual sources are often highly variable in concentrations and flows. Most of the contaminants for these streams are associated with the suspended solids and are removed by effective suspended solids removal. Another characteristic of these streams is their variety of contaminants, both organic and inorganic, as well as potentially toxic contaminants. These characteristics may require more than one treatment process. Commonly used wastewater treatment processes are available to achieve effluent limits for most contaminants. However, applications of treatment processes for dredged material effluents have been generally limited to removal of suspended solids and contaminants associated with these particulates.

b. Liquid treatment technologies can be classified as metals removal processes, organic treatment processes, and suspended solids removal processes. Many of these processes concentrate contaminants into another phase, which may require special treatment or placement. This discussion focuses on suspended solids, toxic organics, and heavy metals. Conventional contaminants, such as nutrients, ammonia, oxygen-demanding materials, and oil and grease, may also be a concern for dredged material effluents. Most of the processes for dissolved organics removal are suitable for these contaminants.

4.8.3.2 Metals removal. Metals removal processes that may be considered for application at CDFs are similar to those commonly used for industrial applications. Processes that are developmental and, therefore, are less likely choices are biological ion exchange, electrocoagulation, and ultrafiltration. Flocculation is effective for removal of metals associated with particulate matter. Polymers and inorganic flocculants have been demonstrated to be effective for removal of suspended solids from dredging effluents, but removal of dissolved heavy metals has not been evaluated in field applications. Ion exchange and precipitation are probably two of the more efficient metals removal processes, but they must generally be designed for specific metals and often require major investments in operational control for efficient operation. Use of man-made wetlands is a relatively new concept for retention of heavy metals and other contaminants from effluents, which could represent a viable option for certain sites and contaminants (Fennessy and Mitsch 1989). More detailed guidance on metals treatment processes as applied to CDFs is available (Cullinane et al. 1986; Averett, Perry, and Miller 1990; USEPA 1994).

4.8.3.3 Organics treatment. The applicability and effectiveness of options for the treatment of dissolved organic contaminants are mostly dependent on the concentration and flow rate of the liquid stream. Mechanical biological wastewater treatment processes are typically not considered because it is doubtful that sufficient organic matter would be available to support biological growth and because operation of biological systems under the conditions of fluctuating flows and temperatures would be difficult. Biological processes such as nitrification, nutrient catabolism, and photosynthesis are important degradation mechanisms for nutrients, oxygen-demanding

materials, and other organics in CDFs. The principal process for dissolved refractory organic contaminants that has been applied to dredged material effluent is carbon adsorption, which was applied to a PCB spill on the Duwamish Waterway in the 1970s (Blazevich and Nicholas 1977). Air and steam stripping could be used for volatile contaminants, but these are generally not a problem for contaminants originating in most dredged sediments. Ultraviolet light (UV) and chemical oxidation processes offer destruction of organic contaminants and are being extensively investigated in the field for a wide range of contaminants. UV and hydrogen peroxide treatment were used for dredged material effluent from the New Bedford Harbor Superfund site (Otis 1994). Created wetlands or phytoremediation also offer potential for retention and degradation of organics. The more effective organic treatment process options are carbon adsorption, chemical oxidation processes, oil separation, and wetlands/phytoremediation. More detailed guidance on organics treatment processes as applied to CDFs is available (Cullinane et al. 1986; Averett, Perry, and Miller 1990; USEPA 1994).

#### 4.9 Contaminant Controls and Treatment.

##### 4.9.1 General.

4.9.1.1 In cases where evaluations of direct physical impacts, site capacity, or contaminant pathways indicate impacts will be unacceptable when conventional CDF placement techniques are used, management actions and contaminant control measures may be considered. Descriptions of commonly considered management actions and contaminant controls are given in the following paragraphs.

4.9.1.2 Site controls (for example, surface covers and liners) can be effective control measures applied at a CDF to prevent migration of contaminants from the dredged material (Cullinane et al. 1986; Averett, Perry, and Miller 1990). The implementation ability and effectiveness of these controls are highly specific to the CDF location and the dredged material characteristics. Use of site controls such as liners, slurry walls, groundwater pumping, and subsurface drainage can be considered for upland sites. Graded stone dikes with low permeability cores or steel sheet pile cutoffs have been used or proposed at upland CDFs to control leachate migration. The low permeability of fine-grained sediments following compaction can reduce the need for liners in many cases, but it can also limit the effectiveness and implementation ability of groundwater pumping and subsurface drainage controls.

4.9.1.3 This section focuses on those contaminant control technologies that have potential application to CDFs with contamination at levels of concern normally associated with navigational dredged material. The most commonly considered contaminant controls for CDFs include the following:

- a. Site operations for contaminant control.
- b. Barrier systems.
- c. Surface covers.

#### d. Liners.

4.9.1.4 Other more complex and expensive control measures are available, including treatment of the sediment solids. However, such measures would not normally be considered for a navigation project. Measures for control and treatment of liquid streams, such as effluent, surface runoff, or leachate, are described in paragraph 4.8.

4.9.1.5 Additional guidance on selection of management actions and contaminant controls for CDFs is available (Francingues et al. 1985; Cullinane et al. 1986; Averett, Perry, and Miller 1990; USEPA 2004). These references contain testing procedures and criteria needed for evaluating and selecting appropriate contaminant control measures for CDFs and should be consulted for additional detailed discussions of the attributes of the various technologies.

4.9.2 Site operations. Site operations can be used as a control measure for CDFs to reduce the exposure of material through the surface water, volatilization, and groundwater pathways. Operational controls may include management of the site pond during and after placement operations. Mobilization of contaminants from dredged material depends on the oxidation state of the solids. Most metals are much less mobile when maintained in an anaerobic reduced condition. On the other hand, aerobic sediments generally improve conditions for biodegradation of organic contaminants. Aerobic sediments generally present the greatest potential for volatilization of contaminants (Thibodeaux 1989). Whether to cultivate or inhibit plant and animal propagation is also an issue. Management of the site both during filling and after placement requires a comprehensive understanding of the migration pathways and the effects various contaminant controls have on the overall mass balance and rate of contaminant releases. The decision to apply certain management options requires trade-offs for the site and contaminant-specific conditions for the project.

4.9.3 Barrier systems. Barriers are layers of low-permeability materials designed to prevent vertical or lateral migration of water and minimize groundwater contamination. Soil barriers can use natural geologic formations of low-permeability material if available at a site or constructed layers. Barrier systems might utilize soils, synthetic membranes, grout mattresses, and slurry walls. Barrier systems can employ a single layer or multiple layers. Complex barrier systems may sandwich layers for lateral drainage, leachate collection, or detection between low-permeability layers. Landfills licensed for hazardous and toxic wastes have strict requirements on the type, number, thickness, and permeability of barriers.

#### 4.9.4 Surface covers.

4.9.4.1 A surface cover is a barrier layer placed on top of a filled CDF. The term “surface cover” is used here to describe both a cap and cover layer for CDFs to distinguish this option from a subaqueous cap as used for contaminant control in the aquatic environment. A cover can be highly effective in reducing leachate generation by preventing rainfall infiltration, isolation from bioturbation and uptake by plants and animals, limiting direct human contact, minimizing volatilization of contaminants from the surface, and eliminating detachment and transport of contaminants by rainfall and runoff. A layer of clean material can achieve the last three benefits mentioned. However, prevention of infiltration requires a barrier of very low permeability, such

as a flexible membrane or a compacted clay layer, both of which are not easily or reliably implemented for CDFs.

4.9.4.2 No surface cover design requirements have been specifically developed for dredged material CDFs, but such guidance is planned under the DOER program. However, design specifications for solid waste or hazardous waste landfill covers may be adapted to CDFs, depending on the material and site characteristics. A vegetative layer may be placed on top of the barrier layer to protect the cap from erosion and sustain certain types of vegetation. The vegetative layer on top should be 0.6 m (2 ft) or more in thickness, depending upon frost depths, root penetration, and the rate of soil loss. Lateral drainage layers may be incorporated into a surface cover design. Surface covers may utilize soil or synthetic membrane liners. Landfills for some regulated wastes have specific requirements for the thickness and permeability of caps. The effectiveness of a cap is highly dependent on the grading and compaction of the fill. Dredged materials may require one or more years to be dewatered/consolidated adequately for cap installation. Uneven settling and consolidation of fill materials can cause localized ponding or cap failure and requires periodic maintenance.

#### 4.9.5 Liners.

4.9.5.1 Liners are commonly considered as a leachate or seepage control measure, and they can be placed on the sides and bottom of a containment area. However, liners have not been used extensively for contaminated dredged material sites because of the inherent low permeability of fine-grained dredged material, the retention of contaminants on solids, and the difficulty and expense of construction of a reliable liner system for wet dredged material.

4.9.5.2 No design requirements have been specifically developed for dredged material CDF liners, but such guidance is planned under the DOER Program. However, design specifications for liners used in design of solid waste or hazardous waste landfills may be adapted to CDFs, depending on the material and site characteristics. Liners may be designed using soils, synthetic membranes, or grout mattresses. Adequate compaction is accomplished by spreading the soil in loose 5 m (6 in.) (or less) deep lifts, wetting and drying to 2% or more above the optimum moisture content, and rolling to the specified relative compaction with a sheeps-foot-type roller (Cullinane et al. 1986). Fine-grained sediments may have permeabilities comparable to clay barriers following compaction. A synthetic membrane liner is generally constructed of polymers of rubber, plastics (PVC), polyolefins, and thermoplastic elastomers that range in thickness from 20 to 140 mil. Effectiveness of these materials depends on quality control during installation. Installation may be difficult in areas of tidal fluctuation and high groundwater table. The membranes are susceptible to leakage due to improper seaming and punctures during installation. Chemical compatibility is a concern with concentrated wastes but is generally not a problem for dredged material. Installation of the primary liner must include protective soil layers above and below the liner. During placement of the primary liner, random samples of seams should be extracted and laboratory tested (Cullinane et al. 1986).

4.9.5.3 Grout mattresses are geotextile “bags” that are filled with a slurry of cement and sand. They are commonly used for streambank or shoreline erosion protection but have also been used as a lateral barrier on the dikes of a CDF at Monroe, MI. The empty geotextile mattresses were

placed against the dike face, then filled with the cement/sand slurry. The product was a layer of hardened concrete, several inches in thickness.

4.9.6 Leachate collection systems. Leachate is water that has had contact with a fill or waste material and may transport contaminants to groundwater. Leachate collection and detection systems are components of landfill designs required for some regulated wastes. Leachate collection/detection systems are essentially the same as the subsurface drainage systems discussed with dewatering technologies. They provide lateral drainage through a network of perforated pipes within a layer of sand or other media. These systems may be positioned above, below, or between barrier layers. The low permeability of fine-grained sediments following consolidation may limit the need for and effectiveness of leachate collection/detection systems.

#### 4.9.7 Slurry walls.

4.9.7.1 A slurry wall is a low-permeability subsurface cutoff wall constructed for the purpose of redirecting groundwater away from a contaminated area to prevent formation of leachates and/or controlling horizontal leachate movement away from the area. Slurry walls are the most common subsurface barriers because they are a relatively inexpensive option for the reduction of groundwater flow in unconsolidated earth materials (Cullinane et al. 1986). The slurry wall is constructed by filling a vertical trench under excavation with a bentonite or bentonite-soil-cement slurry.

4.9.7.2 Slurry walls can be placed circumferential, upgradient, or downgradient. Circumferential placement is most common and offers the following advantages: uncontaminated groundwater entering the contaminated area is reduced, thus reducing the leachate volume generated; the amount of leachate leaving the area on the downgradient side will be reduced; and if used in conjunction with an infiltration barrier and leachate-collecting system, the hydraulic gradient can be maintained in an inward direction, thus preventing leachate escape. Upgradient placement refers to the placement of a slurry wall on the groundwater source side of the contaminated area. This method can be used for the diversion of clean groundwater around a site. While it will not stop leachate generation, it could reduce it (USEPA 1987).

#### 4.9.8 Groundwater pumping.

4.9.8.1 Groundwater pumping is an effective, widely used technology that removes, contains, or prevents development of a plume through groundwater management. For placement facilities, these same techniques can be used to collect leachate or seepage from contaminated dredged material. Plume containment and removal are accomplished primarily with extraction wells that are placed in or around the placement facility. Selection of a well depends on the depth of contamination and hydraulic or geologic characteristics of the media (USEPA 1987). The process directs the flow of groundwater toward a well or wells by pumping. Migration of contaminants away from the well field or out of the placement facility is prevented. Therefore, the contaminated leachate can be recovered and treated. Groundwater pumping applies to granular soils that transmit water. Low-permeability soils, including clay and shale, can adversely affect the process.

4.9.8.2 Well points are effective in many hydraulic situations and are most suitable for placement facilities where extraction is not generally necessary below 6.7 m (22 ft). Well point systems are driven, not drilled, into the ground just below the leachate plume. Groundwater is piped to a suction header and is then drawn by centrifugal pump to a treatment system. Contour grading, revegetation, surface sealing, cutoff walls, and leachate treatment may be used to assist the system (Rishel, Boston, and Schmidt 1984). Costs for well point systems range from \$803 to \$8,284 per well.

#### 4.9.9 Treatment of dredged material solids.

4.9.9.1 Various treatment processes have been investigated for dredged material treatment. Dredged material may be treated at a temporary rehandling facility, with the treated material subsequently being transported to an ultimate disposal facility. Treatment can also be considered for a smaller portion of the total volume of material to create stabilized material for use in constructing liners, covers, and other items.

4.9.9.2 Treatment of contaminated dredged material is a multi-step process, as shown in Figure 4-74. All steps of the process (the process train) must be considered when planning and designing treatment options for contaminated dredged material. These steps are as follows:

- a. Removal or dredging of the sediment.
- b. Transport of the dredged material.
- c. Pretreatment of the dredged material.
- d. Treatment of the dredged material.
- e. Disposal of the dredged material.
- f. Water (effluent and leachate) treatment.

4.9.9.3 The technology types that may be considered for each component are illustrated in Table 4-14. A variety of process options are potentially available for each type of technology; however, prior to recent demonstration programs and Superfund cleanups, only a limited number of treatment technologies had actually been applied on a pilot scale or full scale. The base of experience for treatment of contaminated sediment is still very limited.

a. Pretreatment component. Pretreatment technologies are defined as technologies that prepare or condition dredged material for subsequent, more rigorous treatment processes. These technologies are designed to accelerate treatment, to reduce the water content of the dredged material, or to separate fractions of the sediment by particle size. Pretreatment technology process options include dewatering, debris removal, particle separation or classification, and slurry injection of polymers, nutrients, or other materials. In preparation for any contaminated sediment project, most treatment technologies require storage for flow equalization between the dredging step and the treatment step. A diked storage area similar to a CDF serves this purpose, as well as allowing for dewatering and removal of debris, cobbles, and other large materials.

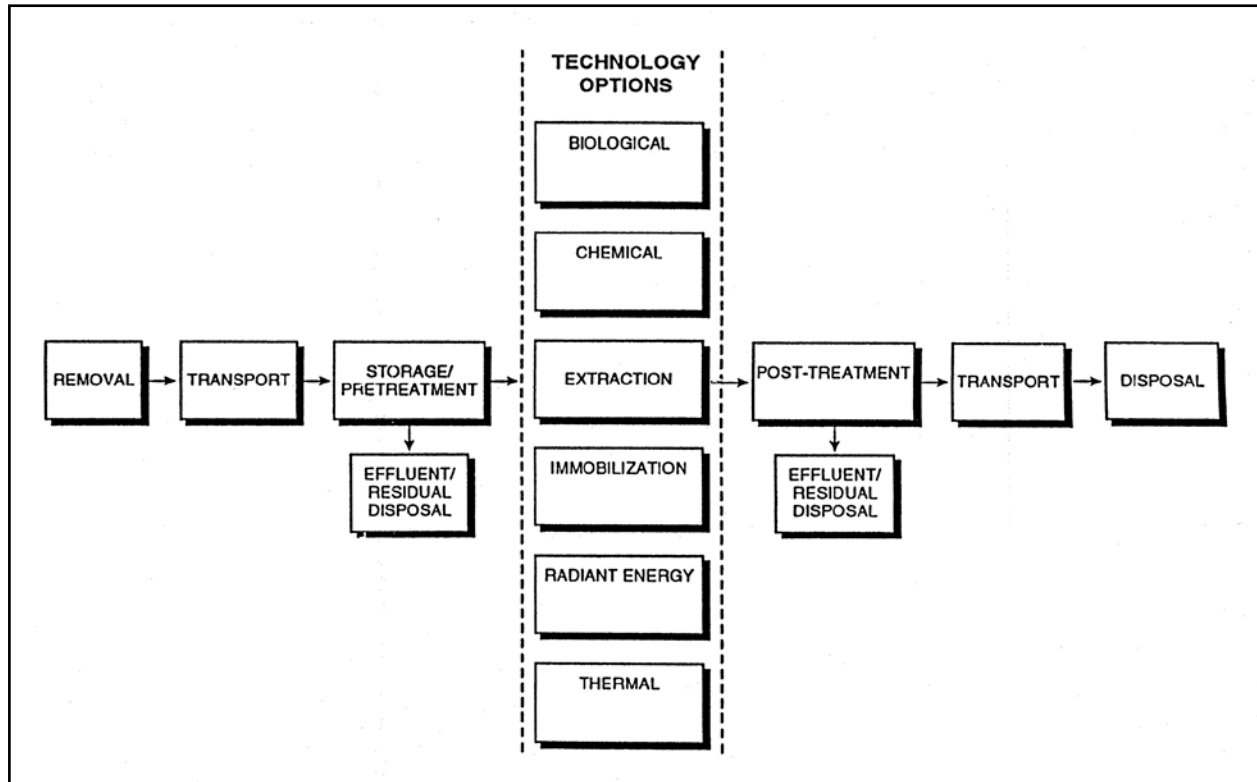

Figure 4-74. Processes of Treatment of Contaminated Dredged Material

b. Treatment component. Many of the process options are not stand-alone processes but, rather, components of a system that may involve multiple treatment processes to address multiple contaminant problems. Most of these processes also require one or more of the pretreatment processes discussed above. Technology types for the treatment component are (1) Biological, (2) Chemical, (3) Extraction, (4) Immobilization, (5) Thermal destruction, and (6) Radiant energy.

(1) Biological processes. Biological degradation technologies use bacteria, fungi, or enzymes to break down PCBs, pesticides, and other organic constituents into innocuous or less toxic compounds. The microorganisms may be indigenous microbes, conventional mutants, or recombinant DNA products. Biodegradation processes have been widely evaluated for contaminated soils and sediments on bench and pilot scales. However, few full-scale cleanups have been completed for those—such as PCBs, dioxins, and high molecular weight PAHs—that are more difficult to degrade compounds. Several of the conceptual processes are proprietary processes that may be available on a pilot scale, and new vendors continue to enter this market. Bioslurry processes are estimated to cost \$80 to \$200/yd<sup>3</sup>. A potentially lower cost would be incurred if biodegradation were accomplished in a CDF. Research being conducted at the U.S. Army Engineer Research and Development Center (ERDC) and elsewhere seeks to develop techniques for CDF management that will effect biotreatment.

Table 4-14. Treatment Alternatives for Remediation of Contaminated Sediments (Tetra Tech, Inc. and Averett 1994)

Process	Previous Testing of						Posttreatment Requirements	Estimated Costs \$/yd <sup>3</sup>	Process Rates yd <sup>3</sup> /day
	Sediments	Dioxins	PCBs	Efficiency %	Pretreatment Requirements	Availability			
	Bench	Bench	Field	<99	Mixing	Available			
<b>Biological Treatments</b>									
Bioremediation	Bench	Bench	Field	<99	Mixing	Effluent	N/A	N/A	
<b>Chemical Treatments</b>									
Dechlorination									
APEG-PLUS	Bench	Bench	Commercial	>99	Drying	None	300-400	150-200	
RREL Base Catalyzed (BCD)	Bench*	Bench	Bench	>99		None	250-300	20	
Dechlor/KGME	Field*	Bench	Field	<99	Dewatering	Effluent, residual	N/A	200	
Eco Logic Thermal Gas-Phase Reduction			Field	25-60	Screening	None	400-600	40-50	
<b>Thermal Desorption</b>									
ReTeC Thermal Desorption	Bench		Bench	In testing	Screening	Air emissions, effluent	250-700	40-60	
Soil Tech Anaerobic Thermal Process	Commercial		Commercial	>99	Screening	Effluent, residual	190-300	100-500	
Thermal Desorption/UV Destruction		Field	Field	>99		Air emissions, effluent	N/A	N/A	
<b>Extraction Processes</b>									
B.E.S.T Solvent Extraction	Field*	Bench	Field	>99	Screening	Residual	170-190	75-100	
Low Energy Solvent Extraction – ART, Inc.	Bench		Bench	<99		Effluent	150-200	150-200	
CF Systems Propane Extraction	Field		Field	<99	Screening	Effluent, residual	200-500	N/A	
<b>Immobilization</b>									
Asphalt and lime addition		Bench	Field	N/A	Dewatering	Containment, monitoring	20-30	N/A	
International waste technologies, chemical fixation		Bench	Field	N/A		Containment, monitoring	130	N/A	
Portland cement and pozzolan	Laboratory		Bench	N/A		Containment, monitoring	50-100	N/A	
<b>Radiant Energy Treatments</b>									
X-Ray Treatment	Conceptual	Conceptual	Bench	>99	Slurry	None	N/A	N/A	
<b>Thermal Treatments</b>									
Rotary kiln incinerators	Bench*	Commercial	Commercial	>99	Drying	Air emissions	350-500	100	
Fluidized-bed incineration		Field	Commercial	>99	Drying	Air emissions	290	130	
Infrared incineration		Bench	Field	>99	Drying	Air emissions	350-800	85-150	
Supercritical water oxidation		Bench	Field	>99	Grinding, Slurry	None	500-850	<100	
Vitrification	Bench	Bench	Field	<99	Dewatering	Air emissions, confinement monitoring	450-500	80-120	

Note: N/A = Estimates are not available.  
\* = Bench testing results are available as part of this study.



(2) Chemical processes. Chemical treatment technologies use chelating agents, bond cleavage, acid or base addition, chlorine displacement, oxidation, or reduction in the destruction or detoxification of contaminants found in the contaminated media. The most widely applied chemical technology is dechlorination of PCBs and other chlorinated aromatic compounds. Process options include the potassium polyethylene glycol process, the base catalyzed dechlorination process, the alkaline metal hydroxide/polyethylene glycol process, and the KGME process (which uses the potassium derivative of 2-methoxyethanol [glyme]). These processes have been demonstrated on bench and pilot scales and have been used for full-scale cleanup of some small contaminated soil sites. Implementation of chemical processes is difficult because of materials handling and process control requirements that have not been fully demonstrated for application to dredged material. Costs for these processes range from \$100 to \$300/yd<sup>3</sup>.

(3) Extraction processes. Extraction is the removal of contaminants from a medium by dissolution in a fluid that is later recovered and recycled in the process or treated. Soil flushing and soil washing are other terms that are used to describe extraction processes, primarily when water is a component of the solvent. A key element of an extraction process is the ability to separate the contaminant from the solvent so that the solvent can be recovered for reuse in the process. Also important is the toxicity of the solvent. Most processes require multiple extraction cycles to achieve high removal efficiencies. Follow-on treatment processes are required to treat or dispose of the concentrated contaminant stream. Implementation of most of these processes is difficult because of the lack of full-scale development for handling sediment and the problems of solvent recovery and potential toxicity of residual solvents. Costs are expected to exceed \$150-\$. \$400/yd<sup>3</sup>.

(4) Immobilization processes. Immobilization processes are defined as technologies that limit the mobility of contaminants for sediment placed in a confined site or disposal area. The environmental pathway most affected by these processes is transport of contaminants to the groundwater or surface water by leaching. Most of the immobilization processes fall into the category of solidification/stabilization (S/S) processes. Objectives of S/S are generally to improve the handling and physical characteristics of the material, decrease the surface area of the sediment mass across which transfer or loss of contaminants can occur, and limit the solubility of contaminants by pH adjustment or sorption phenomena. The effectiveness of S/S processes is usually evaluated in terms of reduction of leaching potential. Reductions are process- and contaminant-specific with immobilization of some contaminants accompanied by increased mobility of others. Implementation of most of these processes is better than chemical or extraction processes because they are not as sensitive to process control conditions. The opportunity for in situ S/S within a CDF is also an advantage. Costs for these processes are generally less than \$100/yard<sup>3</sup>.

(5) Thermal processes. Thermal technologies include incineration, pyrolysis, thermal desorption, sintering, and other processes that require heating the sediment to several hundreds or thousands of degrees above ambient. Thermal destruction processes such as incineration are generally the more effective options for destroying organic contaminants, but they are also the more expensive. Thermal desorption could be considered an extraction process since the organic contaminants are removed from the sediment by volatilization. The small volume of volatilized

31 Jul 15

contaminants must be collected for subsequent treatment. Costs for thermal processes range from \$100 to \$400/yd<sup>3</sup> for desorption processes to more than \$1,000/yd<sup>3</sup> for the more energy-intensive processes such as incineration.

(6) Radiant energy processes. These processes incorporate photodegradation technologies to destroy organic contaminants. X-ray treatment and ultraviolet light have been investigated on laboratory and pilot scales, but they should be considered technologies not yet ready for full-scale demonstration.

#### 4.9.9.4 Treatment technology demonstrations.

a. Some of these treatment processes have been applied in pilot-scale demonstrations, and some have been applied full scale. Examples of the field evaluation of various process options for the above technology types are presented in Table 4-14. The USEPA Assessment and Remediation of Contaminated Sediments Program, the Canadian Great Lakes Cleanup Fund, and the New York Harbor Sediment Decontamination Program have investigated treatment technologies on bench- and pilot-scale levels. The relatively high cost of such treatment alternatives is a major constraint on their potential use, and they have not been used for maintenance dredging projects. A report by the National Research Council (1997) concluded that “because of extraordinarily high unit costs, thermal and chemical destruction techniques do not appear to be near-term, cost-effective approaches for the remediation of large volumes of contaminated dredged sediment.” An international group recently completed a report on “Handling and Treatment of Contaminated Dredged from Ports and Inland Waterways” (PIANC 1996). With respect to treatment, this report concluded “Landfarming, bioslurry treatment, flotation, and gravitational separation are very promising,” and “the costs of treatment are still high, but are decreasing.” Treatment technologies have been used for Superfund cleanup projects at Bayou Bonfouca, New Bedford Harbor, Marathon Battery, and Waukegan Harbor. Costs for these projects ranged from \$100 to \$1,000/yd<sup>3</sup>.

b. The potential for implementation of immobilization processes is better than other treatment processes because immobilization processes are not as sensitive to process-control conditions. Stabilization processes have recently been used for contaminated New York Harbor sediment and at the Marathon Battery Superfund project. The environmental pathway most affected by immobilization processes is transport of contaminants as leachate to the groundwater or surface water. Most of the immobilization processes fall into the category of S/S. Objectives of S/S are generally to improve the handling and physical characteristics of the material, decrease the surface area of the sediment mass across which transfer or loss of contaminants can occur, and/or limit the solubility of contaminants by pH adjustment or sorption phenomena. Effectiveness of S/S processes is usually evaluated in terms of reduction of leaching potential. Reductions are process- and contaminant-specific with immobilization of some contaminants accompanied by increased mobility of other contaminants.

4.9.9.5 Special considerations for nearshore CDFs. Considerations for selection of management actions and contaminant controls for nearshore CDFs are described in Francingues et al. (1985), Cullinane et al. (1986), Averett, Perry, and Miller (1990), and USEPA (1994). However, the geochemical conditions for nearshore fills reduce the need for leachate and effluent

controls. Controls such as liners, leachate collection or groundwater pumping, and subsurface drainage would not be feasible for in-water sites.

#### 4.10 Operation and Management.

4.10.1 General considerations. This section presents procedures for the effective management and operation of containment areas. Management activities are required before, during, and following the dredging operation to maximize the retention of suspended solids and the storage capacity of the areas. These activities include site preparation, removal and use of existing dredged material for construction purposes, surface water management, suspended solids monitoring, inlet and weir management, thin-lift placement, separation of coarse material, dredged material dewatering, and placement area reuse management. Management activities described in this part are not applicable in all cases, but they should be considered as possibilities for improving the efficiency of and prolonging the service life of containment areas.

##### 4.10.2 Predredging management activities.

4.10.2.1 Site preparation. Immediately before a placement operation, the desirability of vegetation within the containment area should be evaluated. Although vegetation may be beneficial because it helps dewater dredged material by transpiration and may improve the effluent quality by filtering, very dense vegetation may severely reduce the available storage capacity of the containment area and may restrict the flow of dredged slurry throughout the area, causing short-circuiting. Irregular topography within the containment area directly affects the resulting topography of the dredged material surface following the dredging operation. It may be beneficial to grade existing topography from planned inlet locations toward the weir locations to facilitate drainage of the area.

4.10.2.2 Use of existing dredged material. If dikes must be strengthened or raised to provide adequate storage capacity for the next lift of dredged material, the use of the dried dredged material or suitable construction material from within the containment for this purpose will be beneficial. In addition to eliminating the costs associated with the acquisition of borrow, additional storage capacity is generated by removing material from within the area. Consideration should also be given to the use of any coarse-grained material present from previous dredging operations for underdrainage blankets or for other planned applications requiring more select material.

##### 4.10.2.3 Placement of weirs and inflow points.

a. General placement for site operation and management control. Outflow weirs are usually placed on the site perimeter adjacent to the water or at the point of lowest elevation. The dredge pipe inlet is usually located as far away as practicable from these outflow weirs or at a location closest to the dredging areas. However, these objectives may sometimes be conflicting. If the placement area is large or if it has irregular foundation topography, considerable difficulty may be encountered in properly distributing the material throughout the area and obtaining the surface elevation gradients necessary for implementation of a surface trenching program. One alternative is to use interior or cross dikes to subdivide the area and thus change the large area into several

smaller areas. Effective operation may require that the dredge pipe location be moved periodically from one part of the site to another to ensure a proper filling sequence and obtain proper surface elevation gradients. Also, shifting inflow from one point of the site to another and changing outflow weir location may facilitate obtaining a proper suspended solids concentration in placement site effluent.

b. Installation and operation of multiple outflow weirs. In conjunction with provisions for moving the inflow point over the placement site, it may also be worthwhile to contemplate installation of more outflow weirs than would be strictly required by design methods. Availability of more outflow points allows greater flexibility in site operation and subsequent drainage for dewatering as well as greater freedom in movement of dredge inflow points while still maintaining the flow distances required to obtain satisfactory suspended solids concentrations in placement site effluent. Also, a higher degree of flexibility in both placement site inflow and outflow control allows operation of the area in such a manner that desired surface topography can be produced, facilitating future surface trenching operations.

#### 4.10.2.4 Interior dike construction.

a. Need for interior dike construction. The basic rationale behind the construction of interior placement area dikes is to subdivide the area into more manageable segments and/or to control the flow of dredged material through the placement area. Control of material placement is normally to facilitate future placement site operations, such as dewatering, or to provide proper control of placement area effluent. An interior dike may also be used as a haul road and access for movement of material for dike construction or other beneficial uses.

b. Economics of interior dike construction. As a general rule, the use of interior cross dikes in any placement area increases the initial cost of construction and may result in increased operating costs. However, facilitation of placement site operations, particularly future dewatering, may result in a general reduction in unit placement cost over the life of the site. The benefit derived from dikes should be evaluated against the amount of placement volume required for their construction. If the dikes can be constructed from dredged material or material available in the placement site foundation and subsequently raised with dewatered dredged material, the net decrease in storage capacity will be approximately zero.

#### c. Placement site operation using subareas in series.

(1) Cross dikes may be used to control and direct the inflow and are normally built to allow site subcontainment area (subarea) operation either in series or in parallel. In series, the flow is routed first into one subarea, with sedimentation producing segregation of larger particles. The overflow from the first subarea is then routed to a second subarea, where finer particles fall from suspension, and then perhaps into another subarea, and so on, with the outflow point being located at the end of the last subarea. In some instances, cross dikes are built across the entire site width, and a long overflow weir is provided to allow outflow into the next subarea in the series. In other instances, spur dikes are built into the containment area to cause a twisting path for the flow.

(2) In general, the use of series-oriented subplacement areas should be considered carefully since their use may be the opposite of that desired by the designer. During placement, coarse-grained sand and gravel settle very quickly around the placement pipe location while other material remains in suspension, depending on its effective particle size, water salinity, and flow velocity. A subarea can be effective in separating coarse material in an area where later recovery for other use will be easier. As a practical matter, a subarea or containment basin to trap or separate specific silt and clay sizes is rather impractical. A rational design for a series of subareas might require an initial subarea to trap sand and gravel, with the remainder of the material (the fine-grained fraction) going to a larger subarea. Then, if desired, a final subarea can be used for retention of fine material in conjunction with the use of chemical flocculants to maintain proper water quality in the placement area effluent. When designing a series of subplacement areas, care must be taken to obtain adequate size. If the first subarea in the series is filled, it will no longer function and provide the required residence time, and its function must be assumed by the next unit in the series.

d. Placement site operation using subareas in parallel. To facilitate site dewatering, operation of interior compartments on a parallel basis may be used. In this concept, flow is initially routed into one compartment; then, when it is filled to the proper depth or when suspended solids concentration standards in the effluent are exceeded, the flow is routed to another portion of the site. This procedure allows more carefully controlled placement of material to the desired thickness throughout the site. Parallel compartments also allow more efficient drying to occur in those compartments not in active use since the water ponded for sedimentation is confined to the active compartment (see Figure 4-75).

e. Sequential dewatering operations. If the placement site is large enough to contain material from several periodic dredgings, each compartment may be used sequentially for a separate operation. In this manner, a sequence such as the following may be developed. The first compartment is filled and, after decant, dewatering operations are initiated. As dewatering operations proceed, the next placement is located in the second compartment and subsequent placement in the third, and so on. While fresh material is being deposited in part of the site, the dewatered material from the initial placement may be borrowed and used to raise perimeter dikes, facilitating reuse of the initial subarea. This sequence of operations is shown in Figure 4-76.

#### 4.10.2.5 Improvement of site access.

a. Adequate provisions for site access are essential when the long-term operation and management plan for a placement site includes provision for future dewatering activities and/or removal of dewatered material for dike raising or other productive use. General considerations for site access may include the following:

- (1) Access roads on or adjacent to perimeter and interior dikes.
- (2) Crossing points on interior ditches used for drainage or dewatering.
- (3) Access for equipment and personnel to reach weir structures for repair or maintenance.

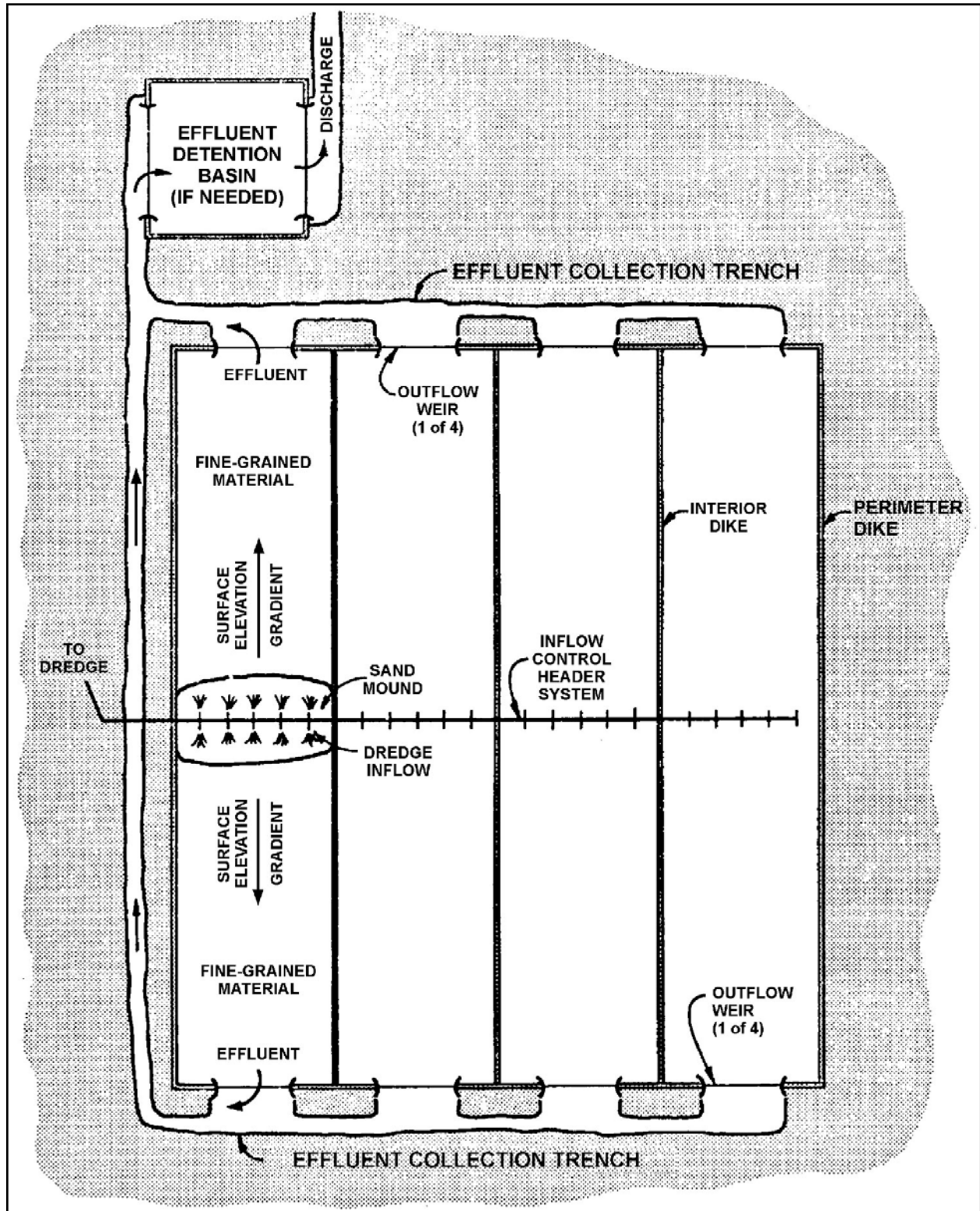

Figure 4-75. Conceptual Illustration of a Placement Site Layout to Permit Parallel Compartment Use and Produce Surface Topography Facilitating Future Dredged Material Dewatering

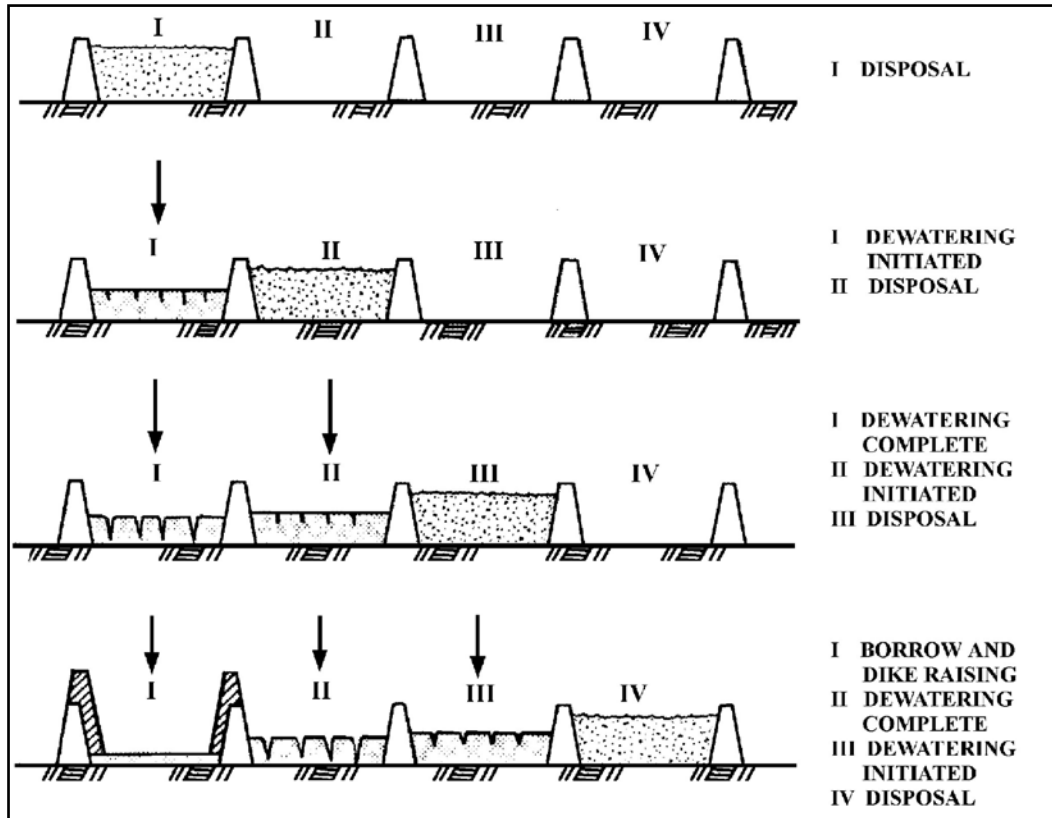

Figure 4-76. Conceptual Illustration of Sequential Dewatering Operations

- (4) Ramps for access onto dikes from both inside and outside dike faces.
- (5) Ramps for pipelines leading to inflow points.
- (6) Equipment turnarounds.
- (7) Stockpiles of materials for sandbagging and emergency dike repairs.
- (8) Offloading ramps for equipment transported by water.

b. If future borrow of interior dewatered dredged material is contemplated, it may be most cost effective to construct small access roads into the area as a substructure for future haul roads or for dragline access. Such stable platforms may be covered with some fine-grained dredged material, but their emplacement in the placement area will allow subsequent equipment operation without immobilization.

4.10.2.6 Scheduling dredging operations to take maximum advantage of climatic conditions.

a. Many non-engineering considerations affect the actual time during which placement operations are conducted:

- (1) Expenditure of funds with respect to fiscal year.

(2) Relative priority of the operation with respect to other work.

(3) Lag time necessary to obtain proper specifications preparation and contract advertisement.

(4) Variation in time when the contractor must move on the job.

(5) Size of the dredge.

(6) Existing weather conditions.

(7) Environmental considerations (dredging windows).

(8) Lag time required for preparation of the placement site.

b. Nevertheless, considerable advantage may be gained, in an engineering sense, from scheduling placement operations to occur at appropriate periods of the calendar year, depending upon prevailing climatic conditions. By conducting the placement phase during a period of relatively low evaporative demands, the initial postplacement activity (the decanting and gradual reduction of ponded water depth) will occur when minimum evaporative forces are available for dewatering. If the placement operation can be scheduled so that the material reaches the approximate decant-point water content when seasonal evaporation rates begin to be maximized, evaporative dewatering will be facilitated. Dramatic results can occur over short time periods when conditions are prime for drying. Estimation of the calendar period for optimum evaporation, based on projected climatic conditions, is illustrated in Figure 4-77. Examples are from the San Francisco, CA, and Mobile, AL, areas. If possible, placement operations should be terminated, ponded water removed, and the material sedimented/consolidated to the decant point by the time (calendar month) when the evaporation rate begins to increase.

#### 4.10.3 Management during placement.

##### 4.10.3.1 Surface water management.

a. The management of surface water during the placement operation can be accomplished by controlling the elevation of the outlet weirs throughout the placement operation to regulate the depth of water ponded within the containment area. Proper management of surface water is required to ensure containment area efficiency and can provide a means for access by boat or barge to the containment area interior.

b. At the beginning of the placement operation, the outlet weir is set at a predetermined elevation to ensure that the ponded water will be deep enough for settling as the containment area is being filled. As the placement operation begins, slurry is pumped into the area; no effluent is released until the water level reaches the weir crest elevation. Effluent is then released from the area at about the same rate as slurry is pumped in. Thereafter, the ponding depth decreases as the thickness of the dredged material deposit increases. After completion of the placement operation and the activities requiring ponded water, the water is removed as quickly as effluent water quality standards allow. Figure 4-78 illustrates the concept.



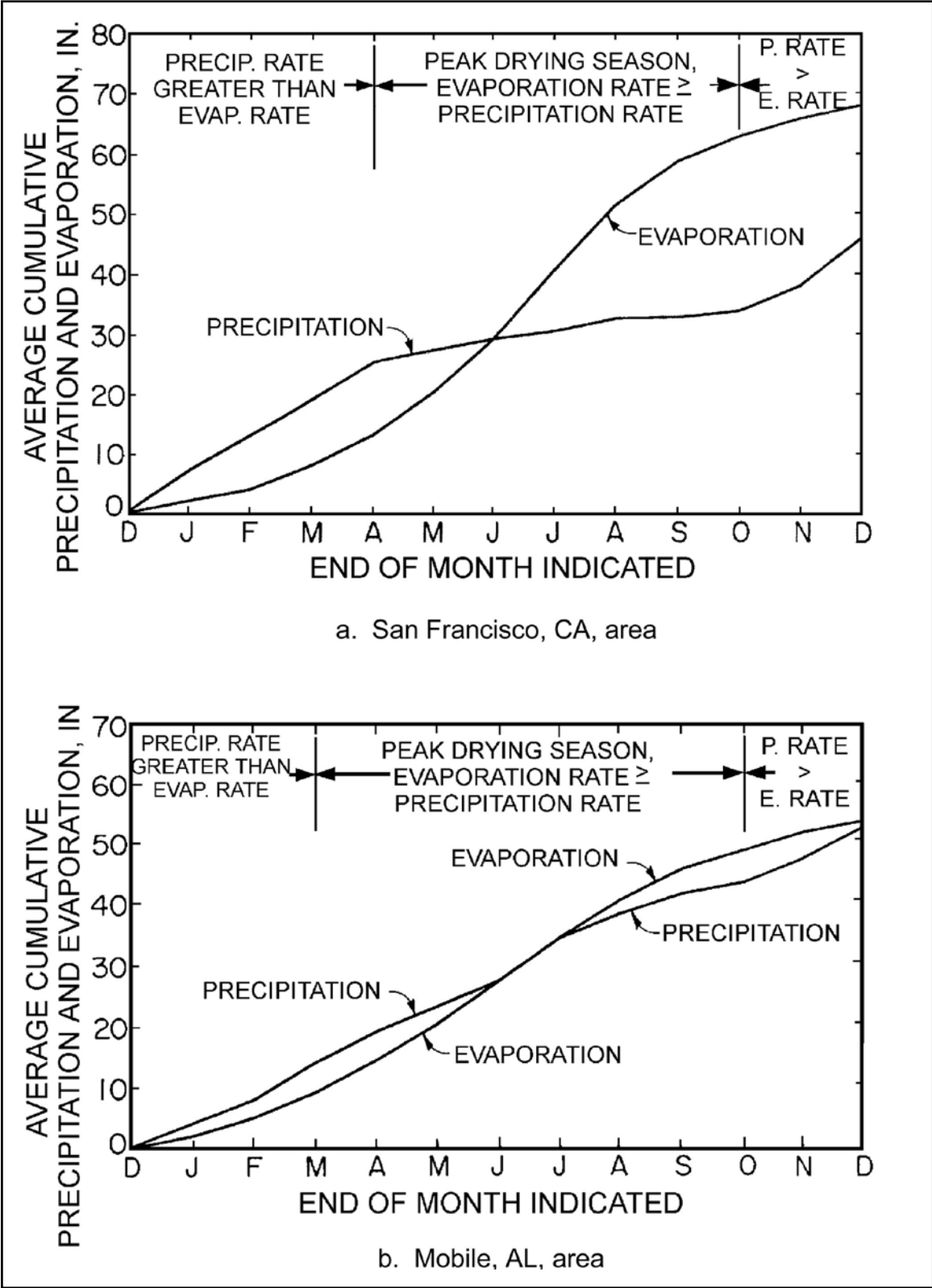

Figure 4-77. Illustrations of the Method for Estimating Calendar Periods when Evaporation Rates are Maximized

31 Jul 15

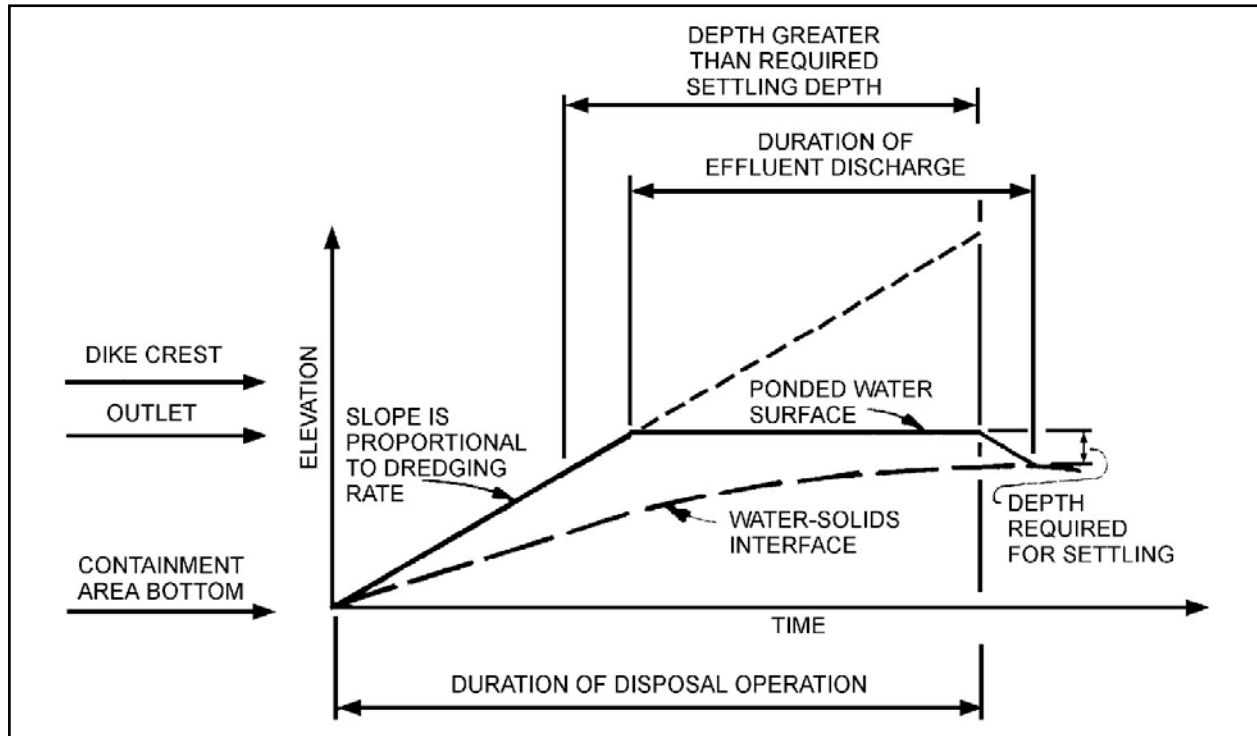

Figure 4-78. Surface Water Management

c. Surface water management during dredging should also consider high rainfall and wind events and subsequent effects on maintenance of sufficient freeboard. For example, if a hurricane is expected during a dredging project, proper operation is to stop dredging and drain water from the CDF.

#### 4.10.3.2 Suspended solids monitoring.

a. A well-planned monitoring program during the entire dredging and decanting operation is desirable to ensure that effluent suspended solids remain within acceptable limits or to verify conditions for future design or site evaluations. Since suspended solids concentrations are determined on a grams per liter basis requiring laboratory tests, it is desirable to complete a series of laboratory tests during the initial stages of operation. Indirect indicators of suspended solids concentration, such as visual comparison of effluent samples with samples of known concentration or utilization of a properly calibrated instrument, may then be used during the remainder of the operation, supplemented with laboratory determination of effluent solids concentrations as needed for record purposes.

b. Samples of both inflow and outflow can be taken for laboratory tests. The solids determination should be made on the samples using the procedure described in Chapter 2, "Dredging and Navigation Project Management."

c. When the dredging operation commences, samples should be taken from the inlet pipe at approximately 12-hour intervals to verify design assumptions. Effluent quality samples should be taken periodically at approximately 6-hour intervals during the dredging operation for laboratory

solids determinations to supplement visual estimates of effluent suspended solids concentrations. The sampling interval may be changed based on the observed efficiency of the containment area and the variability of the effluent suspended solids concentrations. More frequent sampling will be necessary as the containment area is filled and effluent concentrations increase.

#### 4.10.3.3 Inlet and weir management.

a. If multiple weirs are used, discharging the weirs alternately is sometimes useful for preventing short-circuiting. As the area between the inlet and one outlet fills or as the inlet location is moved, the flow may channelize in a more or less direct route from inlet to weir. If this occurs, the flow should be diverted to another weir. Simultaneous discharge of slurry from several inlets located on the perimeter can also be advantageous because the lower velocity of the slurry flow results in more pronounced mounding around the edge of the containment area. This mounding, in turn, increases the slope from inlet to outlet, improving drainage.

b. The removal of water following the dredging operation can be somewhat expedited by managing inlets and weirs during the placement operation to place a dredged material deposit that slopes continually and as deeply as practical toward the outlets. Figure 4-79 shows a containment area with a weir in one end and an inlet zone in the opposite end. Inlets are located at various points in the inlet zone, discharging either simultaneously (multiple inlets) or alternately (single movable inlet or multiple inlets discharging singly). A common practice is to use a single inlet, changing its location between placement operations. The result of this practice is the buildup of several mounds, one near each inlet location. By careful management of the inlet locations, a continuous line of mounds can be constructed. When the line of mounds is complete, the dredged material will slope downward toward the weir. If the mound area is graded between placement operations, the process can then be repeated by extending the pipe over the previous mound area and constructing a new line of mounds.

#### 4.10.3.4 Weir operation.

##### a. Weir boarding.

(1) Adequate ponding depth during the dredging operation is maintained by controlling the weir crest elevation. Weir crest elevations are usually controlled by placing boards within the weir structure. The board heights should range in size from 5 to 25 cm (2 to 10 in.), and their thickness should be sufficient to avoid excessive bending as the result of the pressure of the ponded water.

(2) Weir boarding should be determined based on the desired ponding elevation as the dredging operation progresses. Small boards (for example, 5 cm [2 in.]) should be placed at the top of the weir in order to provide more flexibility in controlling ponding depth. Use of larger boards in this most critical area may result in increased effluent suspended solids concentrations as weir boards are manipulated during the operation. Figure 4-80 shows the recommended weir boarding used for a minimum ponding depth of 0.6 m (2 ft).

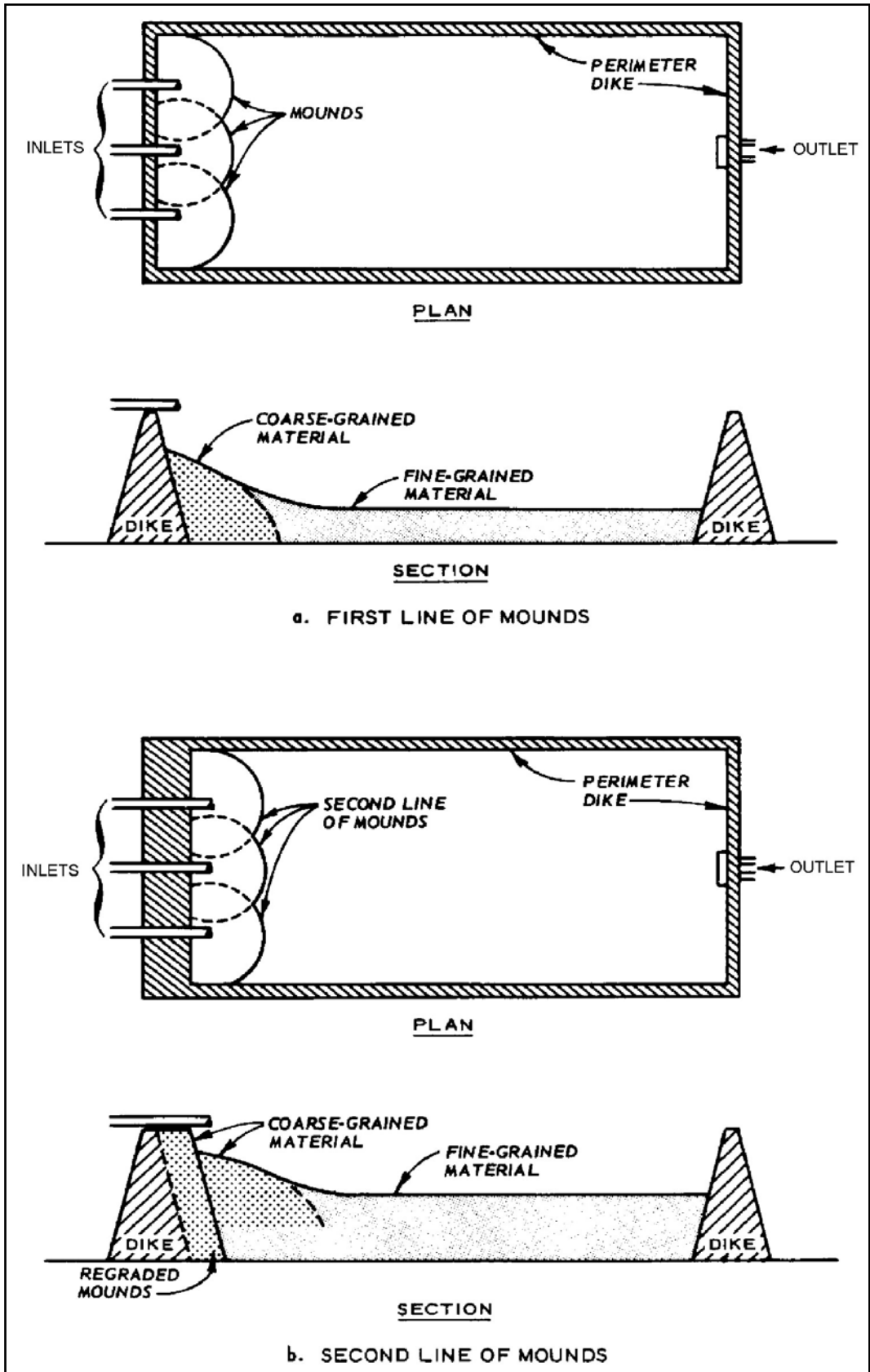

Figure 4-79. Inlet-Weir Management to Provide a Smooth Slope for the Inlet to the Weir

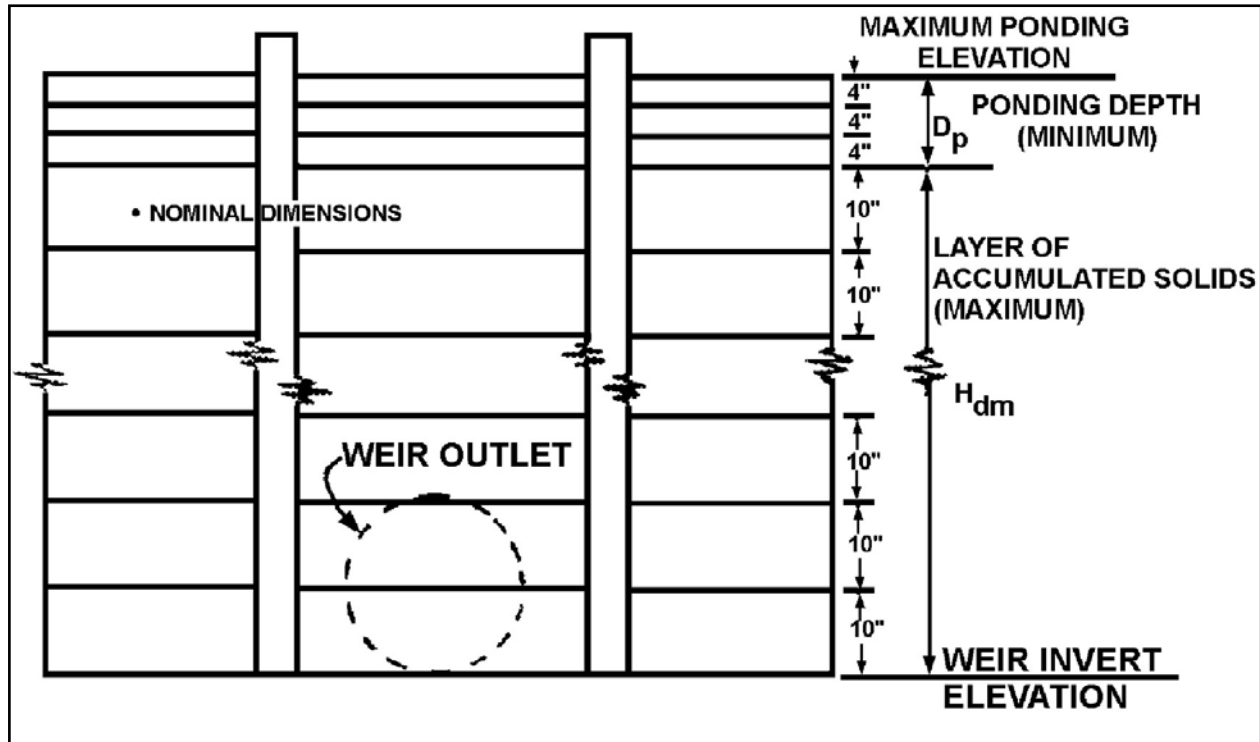

Figure 4-80. Recommended Boarding Configuration

b. Operational guidelines for weirs. Some basic guidelines for weir operation are given below:

(1) If the weir and the placement site are properly designed, intermittent dredging operation should not become necessary unless the required ponding depth cannot be maintained.

(2) While the weir is in operation, floating debris should be removed periodically from the front of the weir to prevent larger withdrawal flows at greater depths.

(3) If multiple weirs, or a weir with several sections, is used in a basin, the crests of all weirs or weir sections should be maintained at equal elevations in order to prevent local high velocities and resuspension in front of the weir with the lower elevation.

(4) If the effluent suspended solids concentration increases above acceptable limits, the ponding depth should be increased by raising the elevation of the weir crest. However, if the weir crest is at the maximum ponding elevation and the effluent quality is still unacceptable, the flow into the basin should be decreased by operating intermittently.

(5) The weir may be controlled in the field by using the head over the weir as an operational parameter since the actual volumetric flow over the weir cannot easily be measured.

The static head with the related depth of flow over the weir is the best criterion now available for controlling weir operation in the field. Weirs used in containment areas can usually be considered

31 Jul 15

sharp crested, where the weir crest thickness  $t_w$  is less than two-thirds the depth of flow over the weir ( $h$ ), as seen in Figure 4-81. The ratio of depth of flow over the weir to the static head ( $h/H_s$ ) equals 0.85 for rectangular sharp-crested weirs. Other values for the ratio of depth of flow to static head for various weir configurations may be found in the *Handbook of Applied Hydrology* (Chow 1964). The weir crest length ( $L$ ), static head ( $H_s$ ), and depth of flow over the weir ( $h$ ) are related by the following equations for rectangular sharp-crested weirs:

$$H_s = \left( 0.3 \frac{Q}{L} \right)^{2/3} \quad (4-3)$$

where

$H_s$  = static head above the weir crest, ft

$Q$  = flow rate, cubic feet per second ( $Q = Q_i = Q_e$  for continuous operation)

$Q_e$  = clarified effluent rate, cubic feet per second

$L$  = weir crest length, ft

and

$$h = 0.85 H_s \quad (4-4)$$

where

$h$  = depth of flow over the weir crest, ft

c. These relationships are shown graphically in Figure 4-82. If a given flow rate is to be maintained, this graph can be used to determine the corresponding head and depth of flow. If the head in the basin exceeds this value, additional weir boards can be added, or the dredge can be operated intermittently until sufficient water is discharged to lower the head to an acceptable level. Since the depth of flow over the weir is directly proportional to the static head, it may be used as an operating parameter. The operator need not be concerned with head over the weir if effluent suspended solids concentrations are acceptable.

d. Weir operation for undersized basins. If the basin is undersized and/or inefficient settling is occurring in the basin, added residence time and reduced approach velocities are needed to achieve efficient settling and to avoid resuspension, respectively. Added residence time can be obtained by raising the weir crest to its highest elevation to maximize the ponding depth or by operating the dredge intermittently. The residence time with intermittent dredging can be controlled by maintaining a maximum allowable static head or depth of flow over the weir based on the effluent quality achieved at various weir crest elevations.

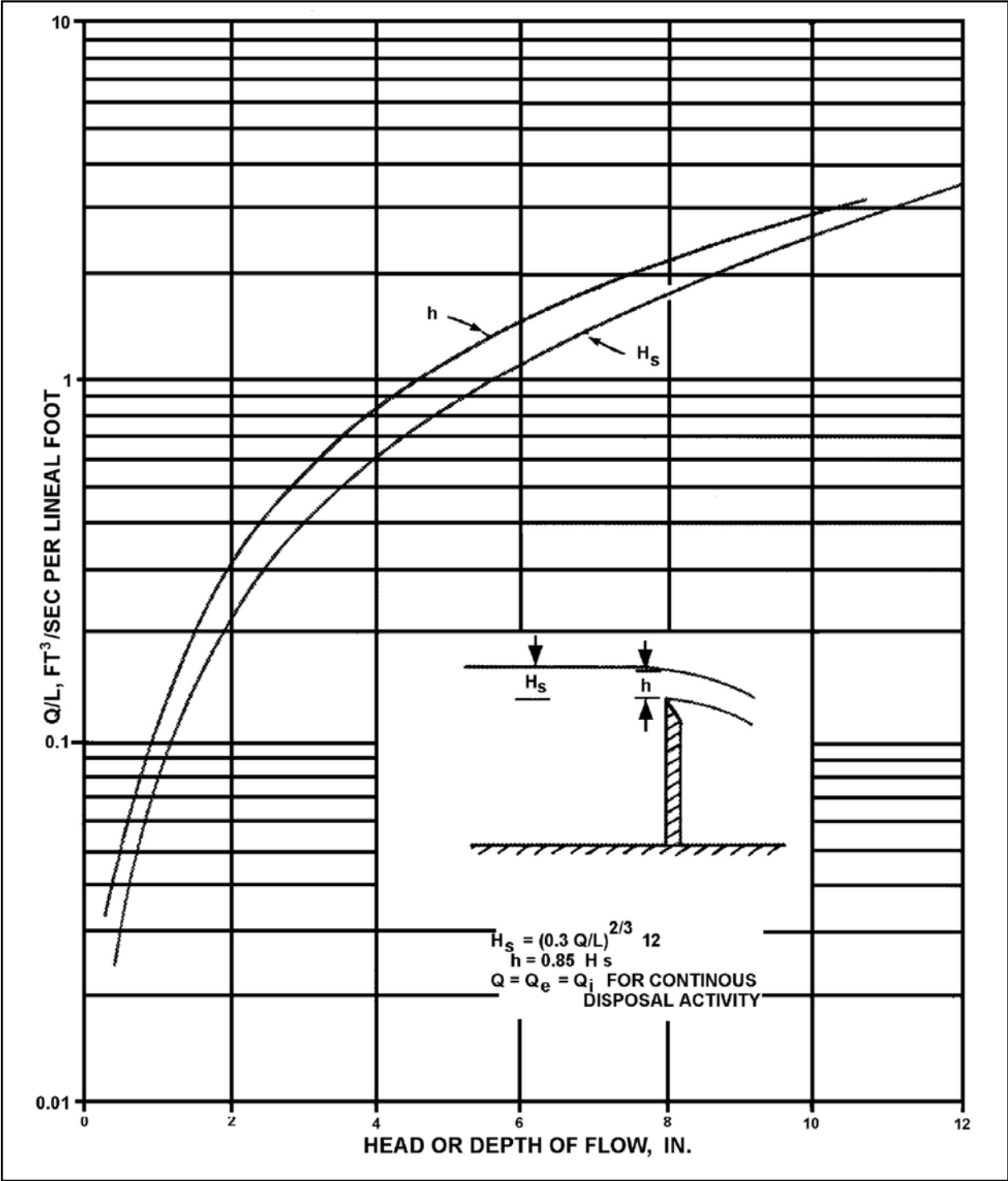

Figure 4-81. Relationship of Flow Rate, Weir Length, and Head

e. Weir operation for decanting. Once the dredging operation is completed, the ponded water must be removed to promote drying and consolidation of dredged material. Weir boards should be removed one row at a time to slowly decant the ponded water. Preferably, 2" x 4" boards should be located as described in previous paragraphs in order to minimize the withdrawal of settled solids. A row of boards should not be removed until the water level is drawn down close to the weir crest, and the outflow is low. This process should be continued until the decanting is completed. It is desirable to remove the boards below the dredged material surface eventually so that rainwater can drain from the area. These boards can be removed only after the material has consolidated sufficiently so that it will not flow from the basin. If it begins to do so, the boards should be replaced. In the final stages of decanting ponded water, notched boards may be placed in the weir, allowing low flow for slow removal of surface water.

4.10.3.5 Thin-lift placement of dredged material. Gains in long-term storage capacity of containment areas through natural drying processes can be increased by placing the dredged material in thin lifts. Thin-lift placement also greatly enhances potential gains in capacity through active dewatering and placement area reuse management programs.

a. One approach to placing dredged material in thin lifts is to obtain sufficient land area to ensure adequate storage capacity without the need for thick lifts. Implementation of this approach requires careful long-range planning to ensure that the large land area is used effectively for dredged material dewatering, rather than simply being a containment area whose service life is longer than that of a smaller area.

b. Large containment areas, especially those used nearly continuously, are difficult to manage for effective natural drying of dredged material. The practice of continuous placement does not allow sufficient time for natural drying. However, dividing a large containment area into several compartments can facilitate operation because each compartment can be managed separately so that some compartments are being filled while the dredged material in others is being dewatered.

c. One possible management scheme for large compartmentalized containments is shown conceptually in Figure 4-77. For this operation, thin lifts of dredged material are sequentially placed into each compartment. The functional sequence for each compartment consists of filling and settling, surface drainage and dewatering, and dike raising (using dewatered dredged material). The operation must be designed to include enough compartments to ensure that each thin lift is dried before the next lift is placed.

#### 4.10.4 Postdredging management activities.

4.10.4.1 Periodic site inspections and continuous site management following the dredging operation are desirable. Once the dredging operation has been completed and the ponded water has been decanted, site management efforts should be concentrated on maximizing the containment storage capacity gained from continued drying and consolidation of dredged material and foundation soils. To ensure that precipitation does not pond water, the weir crest elevation must be kept at levels allowing efficient release of runoff water. This requires periodic lowering of the weir crest elevation as the dredged material surface settles.



4.10.4.2 Removal of ponded water exposes the dredged material surface to evaporation and promotes the formation of a dried surface crust. Some erosion of the newly exposed dredged material may be inevitable during storm events; however, erosion will be minimized once the dried crust begins to form within the containment area.

4.10.4.3 Natural processes often need assistance to dewater dredged material effectively since dewatering is greatly influenced by climate and is relatively slow. When natural dewatering is not acceptable for one reason or another, then additional dewatering techniques should be considered.

4.10.4.4 Removal of coarse-grained material and dewatered fine-grained material for productive uses through Disposal Area Reuse Management (DARM) techniques further add to capacity and may be implemented in conjunction with dike maintenance or raising. In the case of fine-grained dredged material, DARM is a logical follow-up to successful dewatering management activities. This concept has been successfully used by USACE Districts and demonstrated in field studies. Guidelines for determining potential benefits through DARM are found in Montgomery et al. (1978). Additional information on productive uses of dredged material is found in Chapter 5, "Beneficial Uses of Dredged Material."

#### 4.10.5 Long-term management plans for containment areas.

4.10.5.1 Adequate dredged material placement areas are becoming increasingly difficult to secure in many areas of the country. For this reason, it is necessary that the remaining resources of confined placement sites be properly utilized and managed. A management plan is a vehicle that can be used to ensure the most effective use of containment in future years. The following objectives would normally be set in the plan development:

- a. Maximize the volumetric placement capacity.
- b. Dewater and densify the fine-grained material to the greatest extent feasible.
- c. Reclaim and remove any useable material for productive use.
- d. Maintain an acceptable water quality of the effluent.
- e. Abide by all legal and policy and easement constraints.

4.10.5.2 Development of a management plan should include an extensive evaluation of management alternatives based on data accumulated through field investigations and laboratory testing. Integration of the placement plan with overall navigation system needs is essential. The plan should be developed using the latest available technical approaches for evaluation of the benefits of management practices. A management plan developed for the Craney Island placement area in the Norfolk District (Palermo, Shields, and Hayes 1981) is a well-documented example that illustrates how the procedures described in this manual can be used in developing management approaches.

4.10.5.3 A working group or management plan committee is an effective means of ensuring that the plan benefits from the input of all District elements. The committee would logically be composed of representatives from Planning, Engineering, and Operation elements. Once a management approach is selected, a monitoring program should be initiated for use in evaluating the effectiveness of management techniques, especially dewatering activities. A monitoring program serves to verify benefits attained and to form a basis for updating or modifying the management approaches.

#### 4.11 Monitoring.

4.11.1 General. A monitoring program may be developed to comply with regulatory requirements and to operate the CDF effectively. Monitoring could include evaluation of physical and engineering processes and environmental pathways (effluent, surface water, groundwater, plant and animal uptake, and air) identified as being important.

4.11.2 Effluent monitoring. Most CDF monitoring programs are limited to sampling for effluent suspended solids and maintaining good records for the volumes and types of materials placed in the facility. Effluent monitoring may be specified as a requirement under the Section 401 water quality certification. Effluent monitoring is required during filling and may be required for rainfall runoff while contaminated material is exposed (that is, prior to capping with clean material). Chemical analysis of effluent quality may be necessary for highly contaminated sediment. The parameters analyzed should target contaminants of concern that are present in the sediment. More detailed guidance on effluent quality monitoring is available (Palermo and Thackston 1988).

4.11.3 Contaminant pathway monitoring. Monitoring requirements for contaminant releases from pathways, other than effluent, during filling is very site- and project-specific. Leachate monitoring may be required for highly contaminated material where groundwater contamination is an issue. Leachate monitoring requires the installation of monitoring wells for sampling of leachate and/or groundwater and subsequent chemical analyses. Where CDFs become a haven for wildlife, monitoring of contaminant uptake in the food chain may be a consideration. Monitoring of leachate effects and plant and animal uptake involve long-term commitments to monitor the site. Air emissions have seldom been monitored for CDFs; however, air monitoring may be considered where extremely high concentrations of organic contaminants are present in the dredged material and where there is a high likelihood of human receptors.

## CHAPTER 5

### Beneficial Uses of Dredged Material

#### Section I

#### Dredged Material as a Resource

##### 5.1 Introduction.

5.1.1 The Dredged Material Research Program (DMRP), 1973-1978; the Dredging Operations Technical Support (DOTS) Program, 1978-present; the Environmental Effects of Dredging Program (EEDP), 1982-present; the Dredging Research Program (DRP), 1991-1996; the Dredging Operations and Environmental Research (DOER) Program, 1998-present; and the Wetlands Research Program (WRP), 1990-1995, have determined the environmental impacts of dredged material placement, alternatives to increase the beneficial use of dredged material, and means to reduce the adverse effects of both land and water dredged material placement. Technical Reports, Technical Notes, and other publications and products from these programs can be accessed at <http://el.erdc.usace.army.mil/dots/pubs.html>. Interest in using dredged material as a manageable, beneficial resource, as an alternative to conventional placement practices, has increased. The reason for this is that while the amount of material dredged each year continues to rise, increasing urbanization around waterways and ports has made it difficult to locate new sites for containment areas. New environmental regulations have further restricted both land and water placement options. In addition, the cost of dredged material placement has increased rapidly as placement sites are located at greater distances from the dredging sites and environmental controls are added. By considering dredged material as a resource, a dual objective can be achieved. The dredged material from needed navigation and flood-control projects can be placed with minimal environmental damage, and benefits can accrue from its use (Landin 1997a). Most dredged material can be a valuable resource and should be considered for beneficial uses. The DOTS Beneficial Uses of Dredged Material website <http://www.wes.army.mil/el/dots/budm/budm.html> presents information that demonstrates potential beneficial uses of dredged material by presenting case studies as examples. Category descriptions, procedural outlines, and reference resources are also provided.

5.1.2 Identifying, Planning, and Financing Beneficial Use Projects Using Dredged Material (USEPA/USACE 2007), commonly called the “Beneficial Use Planning Manual,” is a companion guide to both the Technical Framework (USEPA/USACE 2004) and the joint USEPA/USACE Beneficial Uses of Dredged Material website. The Beneficial Use Planning Manual builds upon the website’s foundation by providing practical guidance for project sponsors (or example, government agencies, port authorities, marinas, industries, and private persons) and their potential partners for identifying, planning, financing, and implementing projects that use dredged material for beneficial purposes. In particular, this manual does the following:

- a. Describes the various categories of beneficial uses.

- b. Discusses actions and partnerships to improve the feasibility of beneficial use projects.
- c. Describes federal policy on beneficial uses of dredged material.
- d. Presents methods to determine goals and evaluate alternative beneficial uses against the goals for a particular site.
- e. Provides information on available financing opportunities and mechanisms for beneficial use projects.
- f. Describes avenues for public involvement in beneficial use decision making.

5.1.3 The guidance in the Beneficial Use Planning Manual assumes that beneficial use project sponsors are active decision makers in the activities discussed in the Technical Framework. In particular, it assumes that beneficial use project sponsors are or might soon be doing one of the following:

- a. Developing management alternatives for dredged material.
- b. Evaluating management alternatives.
- c. Identifying a preferred alternative.
- d. Performing increasingly detailed planning for the preferred alternative.<sup>1</sup>

5.1.4 When potential beneficial use opportunities for dredged material are being identified, it is important to evaluate the suitability of the dredged material in question for a given use (USEPA/USACE 2007). Physical, engineering, and chemical characteristics of dredged material proposed for beneficial use and land enhancement projects must be identified. Sand or coarse-grained materials generally are not contaminated. Such information is essential for evaluating the suitability of the material for numerous alternative uses. These characteristics must be determined during the initial stages of planning since proposed uses may prove infeasible due to unsuitable material. This section presents discussions of the physical, engineering, and chemical characteristics of dredged material, contaminant and water quality considerations, and some of the limitations that may be encountered with dredged material substrates that may preclude alternatives.

## 5.2 Physical and Engineering Characteristics.

5.2.1 Physical characteristics. A number of standard soil properties are used to determine the physical and engineering characteristics of dredged material (Bartos 1977a). Soil tests include grain-size, plasticity, and organic content determinations. Engineering tests include consolidation and shear strength. Bartos (1977b) indicates that dredged material is made up of various types of soil that can be classified under the Unified Soil Classification System (USCS) (Office, Chief of

---

<sup>1</sup> In many cases beneficial use proponents will, in fact, be conducting a National Environmental Policy Act assessment of alternatives.

Engineers, Department of the Army, 1960). These tests are briefly described below as they relate to beneficial uses (for additional information see Chapter 2, “Dredging and Navigation Project Management”). Additional information on dredged material characterization tests for beneficial uses is given by Winfield and Lee (1999).

5.2.1.1 Grain size. Grain size is the principal physical characteristic to be determined when considering dredged material for beneficial uses, and it is also the basis for most soil classification systems. Land enhancement guidelines presented in this EM for the beneficial uses of dredged material include engineering, environmental, and agricultural projects. For this reason, both the USCS (Office, Chief of Engineers, Department of the Army, 1960) and U.S. Department of Agriculture (USDA) (Buckman and Brady 1960; Lambe 1962) classifications are used. The USCS method emphasizes characteristics of a construction material whereas the USDA method emphasizes soil agricultural properties. The USCS method is the method most often used for classifying dredged material, but for certain beneficial uses it may be necessary to use the USDA method.

5.2.1.2 Bulk density. Bulk density is a weight measurement that takes the entire soil volume into consideration. The bulk density of dredged material is usually low for fine-grained material, but a highly productive agricultural loam soil can range from 70 to 86 lb/ft<sup>3</sup> (Lambe 1962). These low-bulk densities in fine-grained dredged material can be attributed to the sedimentation process and the amorphous nature of the clay. Bulk density data are needed for converting water percentage by weight to water content by volume for estimating the weight of a large volume of material. Examples are the weight of dredged material in a placement site or estimating the volume of dredged material in a dump truck, barge, or railroad car.

5.2.1.3 Plasticity. For USCS classification, the Atterburg LL and PL must be determined to evaluate the plasticity of fine-grained sediment samples. The LL is that water content above which the material is said to be in a semiliquid state and below which the material is in a plastic state. Water content (SCS Engineers 1977) that defines the lower limit of the plastic state and the upper limit of the semisolid state is termed the PL. The plasticity index (PI), defined as the numerical difference between the LL and the PL, is used to express the plasticity of the sediment. Plasticity analyses should be performed on the separated fine-grained fraction of dredged material samples.

5.2.1.4 Specific gravity. Values for the specific gravity of solids for fine-grained sediments and dredged material are required for determining void ratios, conducting hydrometer analyses, and consolidation testing.

5.2.1.5 Water retention and permeability. Water retention characteristics of soil describe the energy relation of soil to water, can be used to determine the availability of water to plants and describe the moisture-storing capacity of a soil (dredged material), and are strongly influenced by the arrangement of the solid components and the quantity of fine particles and organic matter (Table 5-1). The potential available water capacity of a field soil is defined as the amount of water a crop can remove from the soil before its yield is seriously affected by drought (Table 5-2). The permeability and sorptive properties of a material express the ease with which

31 Jul 15

water moves or passes through (Figure 5-1). Permeability is determined by a number of factors; however, the size of soil pores and the magnitude of soil water retention are most important.

5.2.1.6 Volatile solids. Volatile solids are important in determining contaminant retention within a soil or dredged material and the capacity of the material for plant growth and beneficial use.

Table 5-1. Available Water Capacity of Soils of Different Grain Size Range<sup>1</sup>

Grain Size Range	Available Water Capacity at Saturation, Inch of Water per Inch of Soil Depth
Sand	0.015
Loamy sand	0.074
Sandy loam	0.121
Fine sandy loam	0.171
Very fine sandy loam	0.257
Loam	0.191
Silt loam	0.234
Silt	0.256
Sandy clay loam	0.209
Silty clay loam	0.204
Sandy clay	0.185
Silty clay	0.180
Clay	0.156

<sup>1</sup> Source: Gupta et al. 1978

Table 5-2. Available Water Capacity Suitable for Agricultural Crops<sup>1</sup>

Available Water Capacity, Inch of Water per Inch of Soil	Total Available Water Capacity, Inches per Yard of Soil Depth	Recommended Plants
0.05	1.8	Not suitable for most agricultural crops unless irrigated
>0.05-0.075	>1.8-2.7	Best suited for grasses
>0.075	>2.7	Suitable for most agricultural crops

<sup>1</sup> Source: Gupta et al. 1978

5.2.2 Physical properties of dredged material. When hydraulically pumped into a placement area, dredged slurry can have a dry solids content ranging from near 0 to approximately 20% by weight (Johnson et al. 1977). Generally, this value is about 13%. As the slurry flows across the placement area, the solid particles settle from suspension: coarse particles near the inlet (dredge pipe), fine particles farther into the area, and finest materials in the immediate vicinity of the outlet weir. As a placement operation progresses, coarse-grained dredged material may accumulate in a mound and displace the soft fine-grained dredged material.

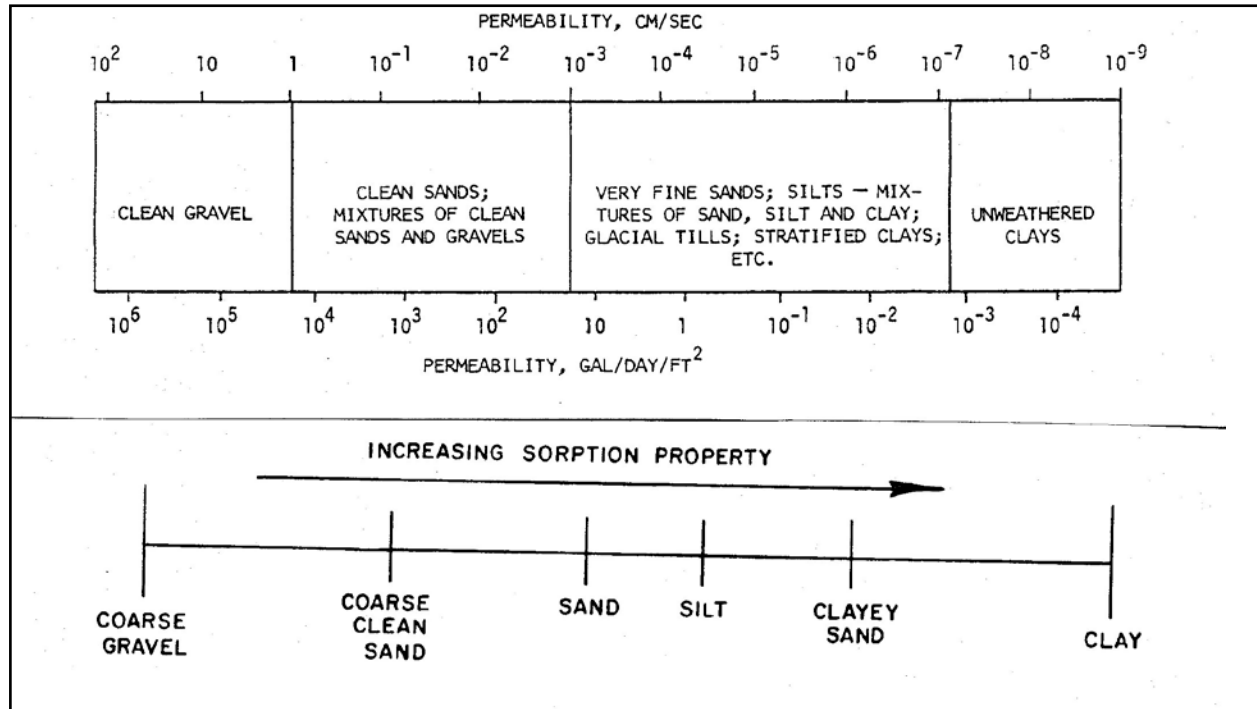

Figure 5-1. Range in Permeability and Sorptive Properties of Different Soil Classes (from SCS Engineers 1977)

5.2.2.1 During and after the placement operation, surface water is drained from the placement area. A surface crust begins to form on fine-grained dredged material as it desiccates. Over time, surface and base drainage cause some lowering of the groundwater table, the surface crust continues to increase in thickness, secondary compression effects develop, and consolidation occurs as the effective material weight above the groundwater level is increased from a submerged weight to a saturated weight. The dredged material below the surface crust remains very soft and weak.

5.2.2.2 The water content of fine-grained dredged material in placement areas is generally less than 1.5 times the LL of the material, and it is possible that in freshwater areas the water content is about equal to the LL. The LL of dredged material is generally less than 200, with most values being between 50 and 100.

### 5.2.3 Engineering properties of dredged material.

5.2.3.1 Engineering properties are critical to determining the types of beneficial uses possible. Soft, fine-grained dredged material has little load-bearing capacity and can generally be used only on sites not involving heavy structures or intensive activities (urban, recreational, or other uses). Chapter 3, "Open-Water Placement," contains more detailed information concerning physical and engineering properties.

5.2.3.2 The surface crust associated with fine-grained material usually has a very low water content (often near the shrinkage limit) that increases slightly with the increasing depth of the

crust. The crust is usually over-consolidated due to the increase in effective stress caused by high negative pore pressure resulting from evaporation. Below the surface crust, however, the fine-grained material is extremely soft, with water content usually showing little change from the time of deposition. Density and shear strength increase very slightly, if at all, with increasing depth. Data show that engineering properties are generally better near the inlet than the outlet because the coarse-grained material settles near the dredge discharge. The engineering properties of the fine-grained material in the containment area near the outlet are poorer and improve very slowly with time. In general, dredged material is soil with a high water content that, upon dewatering, exhibits soil properties with a high beneficial use potential.

### 5.3 Chemical Characteristics.

5.3.1 Chemical constituents. Dredged material characteristics reflect the population, industry, and land uses of an area (Walsh and Malkasian 1978). The chemical constituents of dredged material help determine the suitability of that material for a particular land use (Chen et al. 1976). Chemical analysis of the dredged material must be made to indicate potential detrimental effects on the environment in the placement area. Four potential problem areas exist, depending on the presence of available chemical constituents in the dredged material: plant toxicity, animal toxicity, surface water contamination, and groundwater contamination (Lee, Engler, and Mahloch 1976; Mang et al. 1978). Plant uptake of chemicals may also present problems if growth or reproduction potential of the plant is altered or if harmful chemicals are passed via the food web into higher organisms (Lee, Sturgis, and Landin 1976; Lee et al. 1978).

5.3.2 Cation exchange capacity. The capacity of soil particulates to adsorb nutrients that become available for plant growth is called the CEC. Adsorbed or sorbed nutrients are readily available to higher plants and easily find their way into the soil solution. The grain size and organic content of sediments determine to a large extent the capacity of that material to sorb and desorb cations, anions, oil and grease, and pesticides. Silts and clays with relatively high organic contents can sorb and fix large amounts of plant nutrients as well as many other constituents (Figure 5-1). The CEC of dredged material governs the sorption of nitrogen and potassium, heavy metals, and some pesticides. The nutrient content of dredged material varies widely, as does that of different soils. Generally, fine-grained dredged material contains considerably more nutrients than coarse-grained material and is also more likely to contain one or more contaminants.

5.3.3 Nitrogen. The total nitrogen content of dredged material varies widely with geographic location. The most predominant form of nitrogen in inorganic sediments is ammonium nitrogen. In organically enriched sediments, organic nitrogen predominates even though ammonium concentrations can be very high.

5.3.4 Sulfur. Lee, Engler, and Mahloch (1976) indicate that sediments in a South Carolina tidal marsh developed high acidity when drained and dried. These sediments contained up to 5.5% total sulfur. When the sediments were drained, sulfides were oxidized to sulfate with a resultant decrease in sediment pH from 6.4 to as low as 2.0. This effect may be a serious problem in dredged material containing high levels (usually greater than 0.1%) of nonvolatile sulfide,



predominantly iron and manganese sulfide. This is especially true if the dredged material is not limed or its acidity is not otherwise counteracted by application to an alkaline upland soil.

### 5.3.5 Heavy metals.

5.3.5.1 A wide range of heavy metal concentrations has been reported in a number of sediments from rivers, harbors, and bays throughout the United States and Canada, primarily in intensely urban and highly industrialized regions. Some of the major sources of heavy metals include industrial and sewage discharges, urban and highway runoff waters, and snow removal. Wastes from metal plating industries that have found their way into some sediments contain significant amounts of copper, chromium, zinc, nickel, and cadmium. Chemical partitioning studies of sediments have shown that these metals occupy the least stable of the sediment fractions and that the sediment chemistry dominates the mobility and availability of the contaminant as well as the indigenous metals.

5.3.5.2 An important heavy metal consideration is the solubility of specific constituents whose concentrations are high, since soluble forms are readily available to the biological food web. The potential of a heavy metal to become a contaminant depends greatly on its form and availability rather than on its total concentration within a dredged sediment (Lee, Engler, and Mahloch 1976). Heavy metals may be fixed in a slightly soluble form in dredged material containing excessive sulfide. The land application of dry oxidized dredged material may increase the solubility of heavy metal sulfides. However, under oxidizing conditions, the levels of pH and heavy metal hydroxyl and oxide formation become the important factors, and sulfur no longer governs the solubility and availability of heavy metals (Gupta et al. 1978).

5.3.5.3 The USACE and the USEPA have developed guidelines for sediments, contaminants, and ocean disposal and placement (USEPA/USACE 2004), and guidance for sewage sludge can offer some guidance in examining dredged material for heavy metals (USEPA/USACE Technical Committee on Criteria for Dredged and Fill Material 1991; USEPA 1979). The USDA has investigated and written guidance for the application of sewage sludge to agricultural lands. Recommended maximum limits on the metal content of sludge are shown in Table 5-3. In most cases, the heavy metal contents of dredged material fall below the maximum allowable limits recommended in domestic sewage applied to land. If higher concentrations of chemical constituents are found in dredged material, it should not be used in a land improvement project without prior treatment to remove or reduce contaminants.

## 5.4 Water Quality Considerations.

5.4.1 Categories of impacts. Ecological impacts of the discharge of dredged or fill material can be divided into two main categories: physical effects and chemical-biological interactive effects. Physical effects are often straightforward, and evaluation may often be made without laboratory tests by examining both the character of the dredged or fill material proposed for discharge and the sediments of the placement area. On the other hand, chemical-biological interactive effects resulting from the discharge of dredged or fill material are usually difficult to predict.

Table 5-3. Recommended Maximum Limits for Metal Content in Digested Sewage Sludges<sup>1</sup>

Element	Domestic Sludge Concentration, ppm
Zinc	2,000
Copper	1,000
Nickel	200
Cadmium	15 or 1.0% of zinc
Boron	100
Lead	1,000
Mercury	10
Chromium	1,000

Source: Chaney et al. (1974)

<sup>1</sup> Typical sludge from communities without excessive industrial waste inputs or with adequate abatement.

5.4.2 Concentrations. Natural processes in aquatic ecosystems tend to concentrate heavy metals, chlorinated hydrocarbons, pesticides, nutrients, and oil and grease compounds in bottom sediments. These contaminants are not very soluble in water under the conditions that normally occur in oxygenated uncontaminated surface waters. Therefore, introducing high concentrations of these contaminants into aquatic ecosystems generally results in an equilibrium condition where most of the contaminant are sorbed (adsorbed and absorbed) by suspended particulate material and then deposited on the bottom when the suspended material settles. The time necessary to achieve the equilibrium condition depends on the physicochemical conditions in the aquatic system and the quantity and duration of the contaminant introduction. There has been concern that dredging and open-water discharge operations may release these trapped contaminants again, and thus have the potential to damage wetland, upland, and aquatic environments. Burks and Engler (1978), Gambrell, Kahlid, and Patrick (1978), Thom and Wellman (1996), other EEDP reports, and other literature indicate that dredging operations have the potential to temporarily mobilize or release some contaminants from the sediments. During placement operations, the anaerobic sediments are mixed with aerated surface water, and a complex chemical interaction occurs. Heavy metals such as cadmium, copper, chromium, lead, and zinc, which had been stabilized in oxygen-free sediments, form precipitates and coagulate in the presence of oxygen. Phosphorus and nitrogen can be temporarily released into the water column while pesticides and oils and grease are usually not very water soluble. However, all of these contaminants have the potential to affect a proposed beneficial use project.

5.4.3 Sources of information. The USEPA, in conjunction with the USACE, has published two comprehensive procedure manuals (Gambrell, Kahlid, and Patrick 1978; Plumb 1981) that contain summaries and descriptions of tests, definitions, sample collection and preservation procedures, analytical procedures, calculations, and references required for detailed water quality evaluations. The purpose of these manuals is to provide state-of-the-art guidance on the subjects of sampling, preservation, and analysis of water and dredged and fill material. The interim guidance for implementing Section 404(b) of the Clean Water Act was published in 1976 (Environmental Laboratory 1976), refined in an interagency document published in 1989 (Federal Interagency Committee for Wetland Delineation 1989), and is still being modified at the

present time by new findings and research. It has also been published jointly by the USEPA and the USACE (1991) pursuant to the Marine Protection, Research, and Sanctuaries Act of 1972 (MPRSA), which addresses the primary intent of Section 103 of regulating and limiting adverse ecological effects of ocean dumping.

## 5.5 Contaminated Dredged Material.

5.5.1 A common misperception among the public is that dredged material is usually contaminated; in fact, a significant portion of material dredged from U.S. waters is not contaminated. However, even material that is contaminated may be suitable for certain types of beneficial use although the quality of the dredged material varies, depending on the particular location dredged and the nature of the material itself (sands, silts, and/or clays). Material dredged in some major harbors in the United States is more likely to be contaminated because the material is generally silt and clay particles to which contaminants can easily bind. In any case, the promotion of beneficial uses continues to require a shift from the common perspective of dredged material as a waste product to one in which this material is viewed as a valuable resource that can provide multiple benefits to society (USEPA/USACE 2007).

5.5.2 Assessing the level of contamination in dredged material is a key step in determining its suitability for beneficial uses. In general, the more contaminated the material, the greater the constraints on reuse. Highly contaminated material is usually not suitable for reuse unless its potential risk for biomagnifications is low. The important issue is not so much whether the material is contaminated but whether the level and type of contamination are consistent with the intended use (USEPA/USACE 2007).

5.5.3 Prior to consideration of any dredged material placement option subject to CWA Section 404, the material should be tested and evaluated under the procedures described in the CWA Section 404(b)(1) guidelines for compliance. Basic data on physical and chemical characteristics of the sediments to be dredged, such as grain size and levels of contamination, can provide an initial screen of possible beneficial use options. Assessing whether levels and types of contamination are consistent with intended use requires consideration of not only technical issues (such as potential for human contact and potential for bioaccumulation), but also regulatory and policy issues (such as CWA Section 404(b)(1) guidelines). Regulations vary by state, so it is important to assess state requirements as well as federal policy regarding standards for contamination and reuse (USEPA/USACE 2007).

5.6 Biological Limitations. Although dredged material has been generally found to be a soil resource of great value and use, it has some limitations as a beneficial product.

5.6.1 Texture and physical characteristics. Dredged material is composed predominantly of mineral particles, ranging in size from coarse sand to fine clay, and can have an extremely mixed mineralogy (Lee, Engler, and Mahloch 1976). Dredged material deposits within one placement site can vary from well-ordered sand to organic clay. In addition to soil, dredged material may contain other solids, such as rock, wood, biological detritus, fossils, pieces of metal, glass, and other debris. Contamination of these sediments in the form of organic material, elevated concentration of heavy metals, a vast array of chlorinated hydrocarbons, oil and grease, and other

organics reflects the influences of population and industry in the area. The actual physical texture of the material on a site may limit its use. In other words, pure sand dredged material would not generally be suitable for agricultural land applications, but there are exceptions where heavy clays need modifying with coarse-grained material. However, as fill material and for some dike construction, it may be excellent. Predominantly uncontaminated silt would not generally be well suited for waterbird island construction, but it would make an excellent soil addition for agriculture and forestry as well as for some habitat development sites. Depending on sites and circumstances, however, there are exceptions to every “rule.”

#### 5.6.2 Contamination.

5.6.2.1 In certain areas of the United States, such as near certain industries or extensive agriculture, contamination is an important factor to be considered. If the dredged material contains contaminants, it may have to be pumped into a confined placement facility, which will probably limit its beneficial use. Planning for beneficial use of contaminated dredged material should consider the following factors:

- a. Amounts and type of contaminants in the material, possibly including heavy metals, fertilizers, sewer wastes, pesticides, or petroleum products.
- b. Maximum acceptable levels for pollutants to water, soils, plants, and animals as set by the USEPA.
- c. Kinds of plants and animals on the site, their abilities to regulate uptake of these pollutants, and their tolerance levels before life efficiency is reduced, reproduction eases, or death occurs.
- d. Chances of biomagnification via the food chain from plants, invertebrates, and microbes to animals on the site or to humans.
- e. Impact of contaminants on the site, groundwater, and surrounding areas.

5.6.2.2 Lee et al. (1978) and other studies, such as the series of studies conducted on Black Rock Harbor in New England under the EEDP, listed at <http://el.erd.c.usace.army.mil/elpubs/eedp.html>, have shown that plants grown in dredged material wetlands absorb heavy metals in varying degrees, depending upon the plant species. In most cases, these contaminants in most cases are not generally translocated into the top shoots but are retained primarily in the root systems. Most potential danger is limited to users of the root systems, such as waterfowl that feed on plant tubers. However, research on plants grown in dredged material upland areas where dredged sediments are exposed to oxygen indicates a tendency to accumulate heavy metals in all plant parts, including stems and seeds.

5.6.2.3 Many pesticides, chemical by-products, and petroleum products in dredged material have unknown biomagnification abilities. Some pesticides are known to have affected the reproductive abilities of birds by causing eggshell thinning and behavior modification, especially in those waterbirds and seabirds that feed on fish. Petroleum products can smother small organisms (potential food items). Fertilizers and sewer wastes in dredged material alter the

habitats where they accumulate by changing plant growth habits and species composition, increasing algal growth, and reducing dissolved oxygen levels in water. This affects the food supply of fish-eating animals. Highly acidic dredged material can severely limit upland beneficial use options unless corrected with lime. The contaminant problem can be minimized on most beneficial use sites where contaminated sediments are placed through these management procedures:

a. Stabilizing the areas with plant species that do not transport contaminants into their top shoots.

b. Avoiding management for wildlife grazing, fish nursery use, or intense human use to reduce danger of a biomagnification problem.

c. Managing for animals that will not feed on the site, such as fish-eating birds that use the site for nesting and roosting purposes only. Good examples of this are the Toledo Harbor, OH, and Pointe Mouillee, MI, placement sites in Lake Erie that are being filled over a 20-30-year period with contaminated dredged material. Common terns, ring-billed gulls, and herring gulls are nesting on the dikes but do not generally feed there since they are all fish-eating species.

5.6.2.4 Contaminated sites can be capped with about 0.6 m (2 ft) of clean soil or dredged material. This allows use of the site for a number of beneficial uses involving shallow-rooted plants (for example, nesting meadows, recreational sites, parks, nonstructural, and similar uses).

5.6.3 Site habitat changes. Beneficial uses can frequently mean the replacement of one desirable habitat with another. This will likely be a source of some opposition. There are few reliable methods for comparing the various losses and gains associated with such habitat conversion; consequently, the determination of relative impact may best be made on the basis of relative scarcity or abundance of the new habitat, environmental regulations, or professional opinions. An example would be changing aquatic or marine habitat to an emergent wetland or an upland site.

5.6.4 Impacts on surrounding land and animals. When dredged material is placed on a site for a beneficial use, there may be a number of associated impacts. Examples are increased runoff of nutrient- or contaminant-charged effluent, increased human or other animal use, interference with surrounding land, such as from increased bird activity at placement sites near airport runways and residential areas, increased recreational use in placement sites destined for heavy industrial and shipping use, and changes in hydrology from additions of water-charged dredged material to new or existing sites. An example is Renaud Island in Green Bay, WI, where the intensive utilization and success of nesting ring-billed gulls and the resulting pesting and mobbing made nearby residents of Green Bay request that the dredged material nesting islands not be enlarged.

## Section II

### Logistical Considerations

5.7 General. With the huge quantities of dredged material created during dredging operations, site utilization, economic transport handling, and storage plans become critical to the overall life and use of a project. This section discusses procedures for dewatering; transporting, handling and

storage; and cost analyses of these activities in determining beneficial use of dredged material. It should be remembered that dewatering is not applicable for some types of beneficial uses, such as wetland and aquatic habitat development and aquaculture, although removal of excess standing water where stagnation could occur may be. However, dewatering is critical to nesting islands, upland habitat development, most kinds of recreational use, agriculture, forestry, horticulture, and other types of beneficial uses.

5.8 Dewatering. Dredged material is usually placed hydraulically into confined placement areas in a slurry state. Although a significant amount of water is removed from it through the overflow weirs of the placement area, the confined fine-grained dredged material usually consolidates to a semifluid consistency that still contains large amounts of water. The volume occupied by the liquid portion of the dredged material greatly reduces available future placement volume. The extremely high water content also may make the dredged material unsuitable or undesirable for commercial or beneficial use. Two dewatering methods, fully described and discussed in Green and Rula (1977); Haliburton (1978); Haliburton et al. (1977); Hayden (1978); Montgomery et al. (1978); and Willoughby (1977), are generally used. The first method is allowing evaporative forces to dry fine-grained dredged material into a crust while gradually lowering the internal water table through weir board removal as the site dries. This has been the least expensive and most widely applicable dewatering method identified through dredging research. Good surface drainage, which rapidly removes precipitation and prevents ponding of surface water, accelerates evaporative drying. Shrinkage forces developed during drying return the material to a more stable form, and lowering of the internal water table results in further consolidation. The second method of promoting good surface drainage is constructing drainage trenches in the placement area using heavy equipment while removing weir boards as the site dries. Use of a Riverine Utility Craft (RUC) to make trenches proved successful on placement sites with fine-grained material, but the technology has not been commonly used on USACE placement sites. For more detailed information on trenching, refer to paragraph 4.5.4.6. A site must be dewatered sufficiently to accept heavy equipment, which limits the second method in its application as long as 2 years after a placement site has been filled, depending upon the soil characteristics of the dredged material. A less frequently used method, rarely applied to placement sites, includes installation of underground drainage tiles or sand layers prior to filling the site.

5.9 Transport, Handling, and Storage. Fundamental features of transport systems and general guidance for analysis of technical and economic feasibility are provided in Souder et al. (1978). They are presented to acquaint planners with the magnitude and scope of the transport system and provide some cost-effective analysis information for five transport modes: hydraulic pipeline, rail haul, barge movement, truck haul, and belt conveyor movement. Hydraulic pipeline, barge haul, and truck haul have been the primary transportation methods used for most existing beneficial use sites. Since the transport of dredged material can be a major cost item in determining the economic feasibility of a project, the transport system should be evaluated early in the site selection stage of the planning process. Legal, political, sociological, environmental, physical, technical, and economic aspects should be examined in relation to availability of transport routes. A sequence of five steps must be followed when selecting a transport route (Table 5-4).

Table 5-4. Sequence of Steps in Selecting a Transport Route

Step	Information Source
1. Identify available routes	- Maps, ground reconnaissance
2. Classify nature (wet/dry)	- Beneficial use needs and sources of dredged material
3. Determine annual volume of dredged material and duration of project	- Dredged material sources
4. Estimate cost of available transport modes	- Souder et al. (1978)
5. Identify and evaluate technical, environmental, legal, and Federal agency regulations	- Souder et al. (1978) - Specific sources: local, state, institutional requirements

5.9.1 Elements of transport systems. Transport systems involve three major operations: loading, transporting, and unloading. The loading and unloading activities are situation-dependent and are the major cost items for short-distance transport. The hydraulic pipeline is the only mode requiring a unique rehandling activity; all other transport modes may interchange loading and unloading operations to suit the specific site needs. Loading, unloading, and transporting operations can be separated into detailed components (backhoes, service roads, rail spurs, cranes, conveyors, and so on) and each component examined for capacity, operational schedule and cycle, and costs of equipment and operation and maintenance.

#### 5.9.2 Transport modes.

5.9.2.1 Hydraulic pipeline. The hydraulic pipeline is the only transport system recommended for movement of dredged material in slurry form. Assuming government construction of the placement site, contractor operations of the dredging work, and no easement costs, this system can be economically competitive for distances up to several miles. The conditioning step requires a rehandling dredge and fluidizing system. Control of density and flow to minimize operational problems is an essential conditioning process unique to the hydraulic pipeline mode. Suggested criteria to be used in selecting a rehandling (or secondary) dredge for operation within a containment area include unit cost of dredging; ease of transportation; minimum downtime; small size to allow maneuverability in a small basin; capability to dredge in shallow water to minimize dike height; and maximum cutter width to reduce the number of passes. Numerous dredges fitting these criteria are on the market. Some have additional features, such as cutterheads capable of following natural contours of the basin bottom without damage to natural or man-made seals, wheel attachments for the cutterhead to allow dredging operations in plastic or rubber-lined basins, and capability of dredging forward and backward. The fluidizing system is needed to supply water from the closest source to maintain flotation of the dredge. Unloading facilities are unnecessary since the dredged material slurry is usually pumped out of the pipeline into a containment area. A schematic of rehandling operations for hydraulic pipeline transport is presented in Figure 5-2. The pipeline to the land improvement site includes a pneumatic or centrifugal hydraulic pump booster system and is automated to the maximum extent possible. The following items should be taken into consideration in any planning for pipeline transport:

31 Jul 15

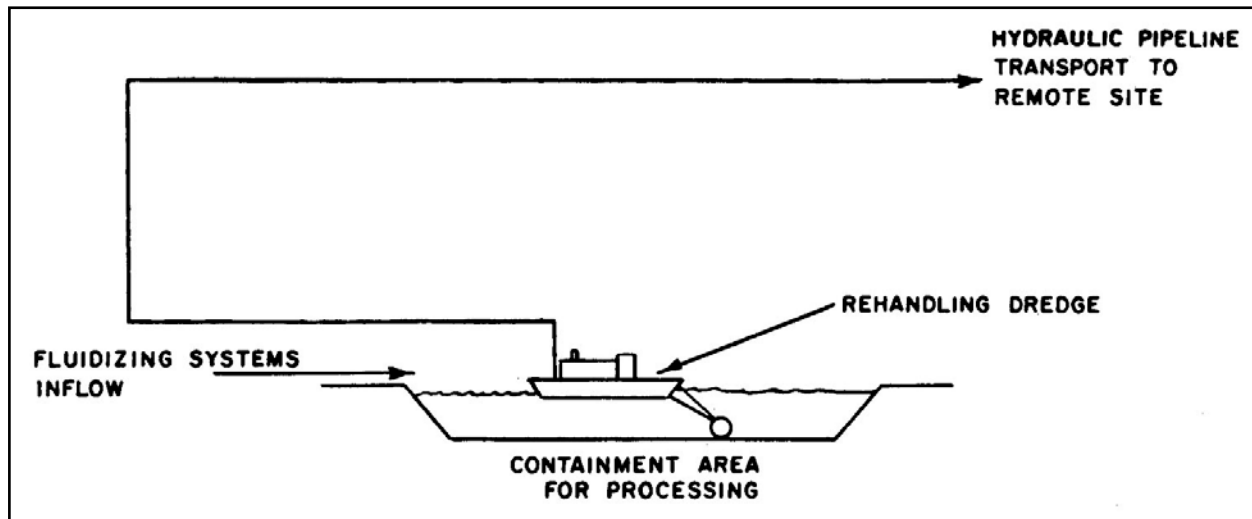

Figure 5-2. Schematic of a Rehandling System for Hydraulic Pipeline Transport

- a. Slurry movement of saline dredged material to a freshwater environment is not recommended.
- b. Dewatering requirements before a beneficial use application may be a cost burden and may require treatment of decanted water.
- c. Building codes, easement acquisition, utility relocation, climatological factors, and urban area disruption from construction may be obstacles.
- d. Confining dikes must be provided and could be a significant cost item.
- e. Right-of-way must be acquired.
- f. Federal, state, and local regulations and requirements must be met.

Real estate and right-of-way easements are very site-specific items of political as well as economic concern. These items can greatly impact the cost of a hydraulic pipeline system and, therefore, should be given due consideration in any cost-benefit analysis as well as in the final cost evaluation. Cost guidelines do not take into account expenses due to the uniqueness of each situation.

5.9.2.2 Rail haul. Rail haul using the unit train concept is technically feasible and economically competitive with other transport modes for hauling dredged material distances of 80-480 km (50-300 mi). A unit train is one reserved to carry one commodity (dredged material) from specific points on a tightly regulated schedule. Facilities are required for rapid loading and unloading to make the unit train concept work and to enable benefits from reduced rates on large volumes of bulk movement. Bottom-dump cars or rotary car dumpers are needed to meet the rapid loading and unloading requirement. Economic feasibility demands the utilization of existing railroad tracks; however, the building of short intermediate spurs may be required to



reach placement areas. The following items should be taken into consideration in any planning for rail haul transport to a beneficial use site:

- a. Dredged material must be dry enough to free-fall from cars.
- b. Scheduling and length of unit trains are often strictly regulated.
- c. State regulations may require open hopper cars to be covered.
- d. Dual use of hopper cars may require washing of cars between use and treatment of wash water to prevent contaminant transfer.

5.9.2.3 Barge haul. Depending upon the volume of material to be moved, barge movement can be an economically competitive transport mode for the movement of dredged material up to 480 km (300 mi). Barge haul was used in the Sacramento District to remove 5.4 million cubic meters (7 million cubic yards) of dredged material from Grand Isle (Figure 5-3). To ensure reasonable costs, a barge unit should consist of common and available equipment. In addition, loading and unloading mooring docks capable of accommodating the two cargo scows simultaneously must exist, with roadways between the docks and placement areas to make barge transport practical. The following items should also be taken into consideration:



Figure 5-3. A Tugboat and Barge Transporting Dredged Material

- a. Thorough information must be obtained about the waterway, such as navigation depth, allowable speed, lock size, and traffic density and patterns.
- b. Often, regulations exist concerning cleanup responsibilities, with associated fines for spills in inland waters.

- c. Climatic conditions may affect operational schedules.
- d. A user charge for waterways may become a reality in the future.

5.9.2.4 Truck haul. Truck haul of dredged material can be economically competitive for distances up to 80 km (50 mi). At greater distances, transport by truck is labor- and fuel-intensive and not economically justifiable. The simplicity of loading and unloading requirements and the relative abundance of available roadways make truck hauling technically the most attractive transport mode, and it has wide District application (Figure 5-4). Cost analyses are based on utilizing 25 tonne (25 ton) dump trucks with 6.5 m<sup>3</sup> (8 yd<sup>3</sup>) capacities and assume that routes exist that are adequately upgraded and maintained. Economic feasibility of truck hauling is based on rates established by negotiation with trucking companies and include all associated driver and fuel costs. The following items should also be taken into consideration:

- a. State highway and safety regulations, which cover a variety of elements (such as gross weights of trucks and weight per axle).
- b. Emission and noise standards.
- c. Local ordinances designating truck routes.
- d. Traffic control of truck operations during winter months in northern climates.
- e. Weight limits on bridges and roadways.

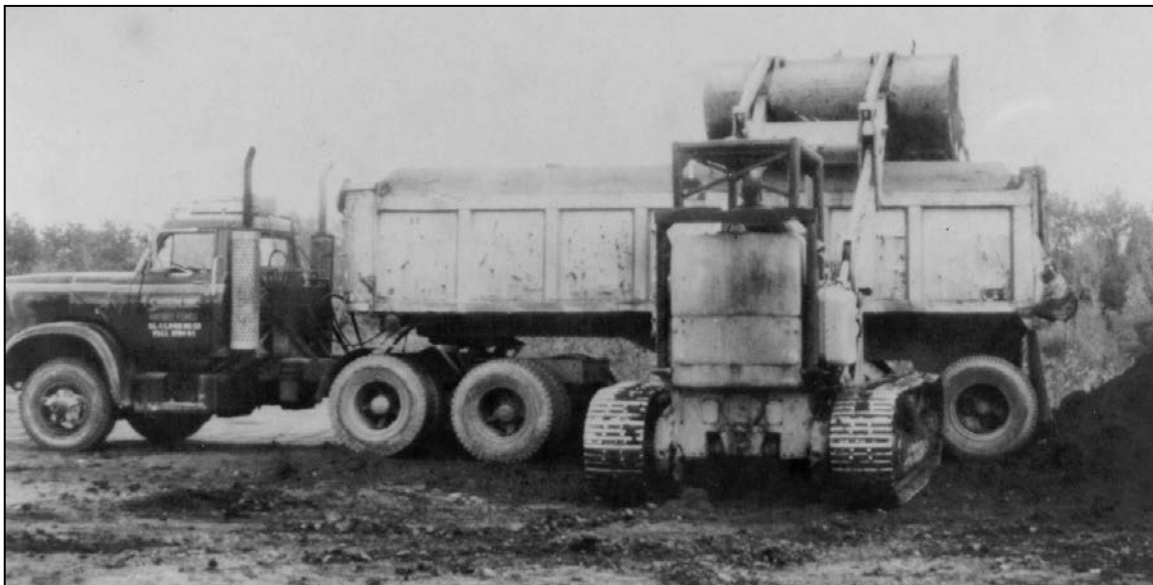

Figure 5-4. Truck Haul Used by the Chicago District to Place Dredge Material

5.9.2.5 Belt conveyor movement. Belt conveyor systems, employed on a limited basis to transport relatively dry dredged material for short distances, are technically feasible and cost competitive. Belt specifications vary in width (75-175 cm [30-69 in.]), flight length (277-800 m

[910-2,625 ft]), and speed (7-144 km/h [4-90 mph]). Systems can be designed to suit project needs excluding certain terrain difficulties. Because of system flexibility, belt conveyors fit neatly into many loading and unloading operations. The California Highway Department, under an agreement with the Sacramento District, uses dozers and conveyors to load dredged material onto barges (Figure 5-5). The following items should be taken into consideration in any planning for belt conveyor transport:

- a. Building codes, easement acquisition, utility relocation, climatologically factors, and urban area disruption for construction.
- b. Material pileup due to system failure.
- c. Malfunctions of sequential belt systems resulting in entire system stoppage.



Figure 5-5. A 1 m (3.3 ft) Belt Conveyor Dredged Material Loading Operation

5.9.3 Loading and unloading elements. Loading and unloading elements may incur high costs, which can restrict project viability. Souder et al. (1978) present several examples of loading and unloading options and schematics of scenarios associated with various dry material transport modes; two examples are shown in Figures 5-6 and 5-7. Two other examples include a pair of backhoe excavators and a series of conveyor belts providing rapid loading of unit trains, and a barge haul scheme using backhoes for excavation and loading directly into dump trucks, which make the intermediate haul to the scows. In this EM, cost comparisons are based on the loading and unloading component scenarios presented in Souder et al. (1978). The truck haul loading element components are similar to the rail loading components, which include excavation backhoes and a series of belt conveyors. The unloading system is simple back-dumping at the beneficial use site. Placement methods are important and are discussed in paragraph 5.26.2 and other sections where critical elevations are needed for beneficial use applications.

31 Jul 15

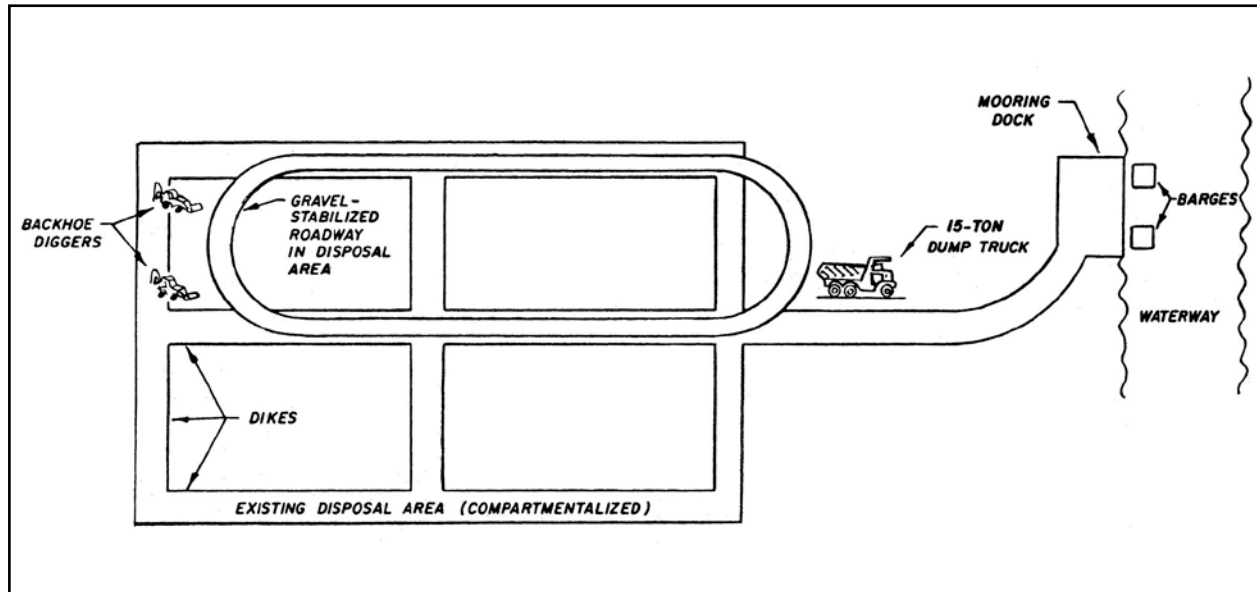

Figure 5-6. Barge-Loading Operation

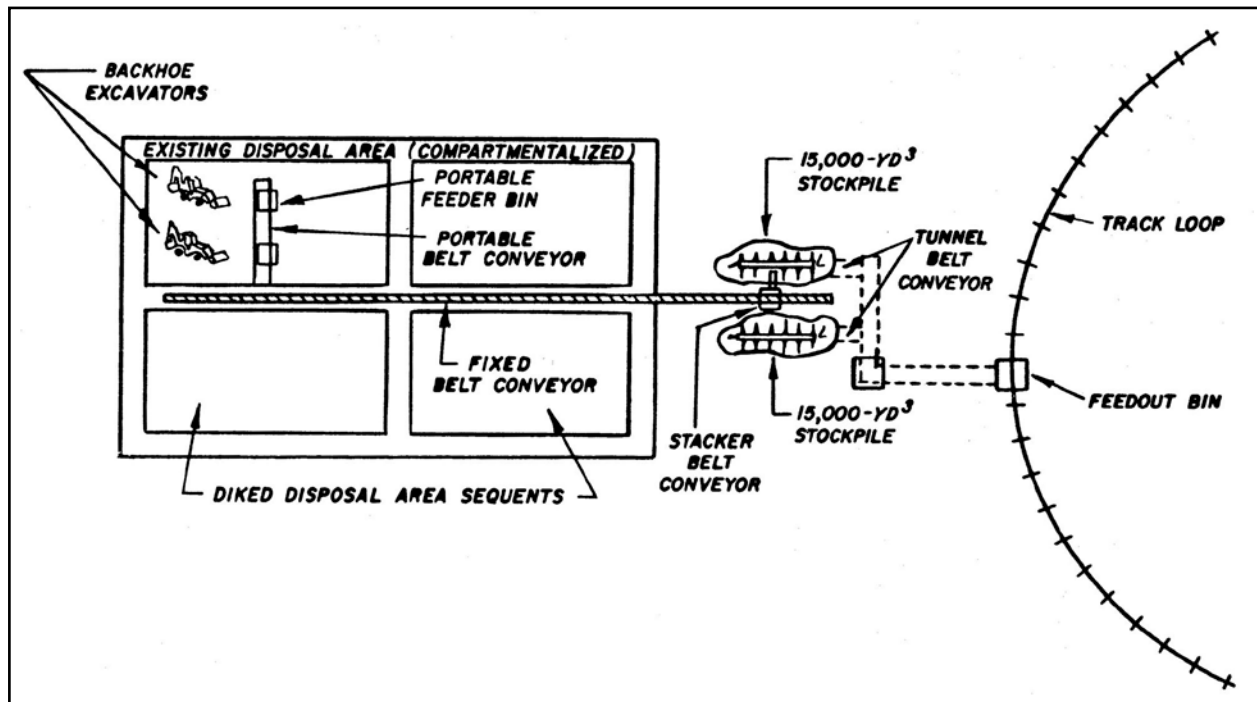

Figure 5-7. Unit Train Rail Loading Facility

### 5.10 Cost Analysis for Dewatering and Transport.

5.10.1 Dewatering costs. Costs associated with dewatering of dredged containment areas are directly related to the degree of trenching effort required and the type of heavy equipment necessary to accomplish dewatering. Thus, the program costs for progressive trenching are highly site-specific depending upon placement area size, equipment selected, type of access available,

and frequency of trenching operations. A preliminary trenching program is developed from crust formation estimates, equipment operational characteristics (Table 5-5), and trenching cycle intervals (Table 5-6). Total cost may be estimated from computing equipment operating hours plus factors for nonproductive activities (30% is a good estimate), mobilization/demobilization, and administrative costs.

Table 5-5. Operational Characteristics of Trenching Equipment

Equipment	Crust Thickness, cm, for Effective Operation		Maximum Trench Depth, cm	Approximate Trenching Rate lin m/hr	Approximate Rental Cost <sup>1</sup> \$/hr
	Minimum	Maximum			
RUC	0	30	45	600+	275-360
Low-ground- pressure tracked vehicle + rotary trenchers	10	62.5	62.5	600+	125-160
Small dredge	10	25	75	8	180-270
Amphibious dragline	12	45 <sup>2</sup>	Crust + 45	12	180-255
Small dragline on double mats	30	45	Crust + 45	9	125-180
Medium dragline on double mats	30	45	Crust + 45	12	145-180
Small dragline on single mats	45	62.5 <sup>3</sup>	Crust + 45-62.5	15	125-160
Medium dragline on single mats	45	75 <sup>3</sup>	Crust + 45-62.5	18	145-180
Large dragline on single mats	62.5	90	Crust + 62.5	24	160-200

## Notes:

- (a) Vehicle or mat ground pressure must also satisfy critical layer Rating Cone Index mobility criteria.  
 (b) Low-ground-pressure tracked vehicle assumed to pull drag plow with point set only 2.5 or 5 cm (1 or 2 in.) below existing crust.  
 (c) More exact definitions of dragline equipment given in text.

<sup>1</sup> Southeastern United States, 1977. Adjusted by the Bureau of Labor Statistics, Consumer Price Index Inflation Calculator, 2008.

<sup>2</sup> Above this crust thickness, conventional dragline is usually more efficient.

<sup>3</sup> 62-75 cm (25-30 in.) crust thickness, use single mats. Increase rates 3 lin m/hr if dragline is working from perimeter dike.

Table 5-6. Estimated Interval Between Trenching Cycles for Various Equipment Items in Fine-Grained Dredged Material

Equipment Item	Equipment Location in Placement Area	Initial Condition of Placement Area Surface	Estimated Trenching Interval
RUC	Interior	Decant point	Each 2 weeks for the first month, and monthly thereafter
RUC	Interior	Crust $\geq$ 5 cm (2 in.)	Monthly
Low-ground-pressure-tracked vehicle + rotary trencher	Interior	Crust $\geq$ 5 cm (2 in.)	Monthly
Small dredge	Interior	10 cm (4 in.) < crust - 25 cm (10 in.)	4 months
Amphibious dragline	Interior	Crust $\geq$ 15 cm (6 in.)	4 months
Conventional dragline	Interior	Crust $\geq$ 30 cm	4 months
Conventional dragline	Perimeter	Decant point	Monthly for the first 3 months, bimonthly for the next 3 months, and 4 months thereafter
Conventional dragline	Perimeter	5 cm (2 in.) < crust < 15 cm (6 in.)	Bimonthly for the first 4 months and 4 months thereafter
Conventional dragline	Perimeter	Crust $\geq$ 15 cm (6 in.)	4 months

5.10.2 Transport costs. Transport cost can account for 90% or more of total land improvement and beneficial use budget costs. The cost figures presented in this section are meant to serve as examples for planning and do not represent definitive cost estimates. Table 5-7 provides insight into the cost relationships for various modes of transport. It provides total system costs for all five transport modes. Transport costs are reported in dollars per cubic yard of dredged material moved. This breakdown shows that economic feasibility is limited by distance for most transport modes. This table also shows the economies of scale for larger annual volumes of material shipped. Real estate and right-of-way costs for the hydraulic pipeline system are not included in the cost-estimating procedure.

Table 5-7. Comparison of Costs of Various Transport Systems, Quantities, and Distances<sup>1</sup>

Annual Quantity, m <sup>3</sup>	Transport Distance, km	Cost, \$/m <sup>3</sup> , for Cited Transport System				
		Pipeline	Rail	Barge	Belt	Truck
500,000	16	6.82	<sup>2</sup>	6.82	24.78	12.61
	32	8.66	<sup>2</sup>	8.66	41.80	18.24
	160	26.32	19.81	13.00	<sup>2</sup>	37.77
	400	<sup>2</sup>	25.72	20.45	<sup>2</sup>	<sup>2</sup>
1,000,000	16	4.03	<sup>2</sup>	8.06	14.87	10.29
	32	5.27	<sup>2</sup>	8.66	37.17	11.56
	160	17.80	14.87	12.39	<sup>2</sup>	35.62
	400	<sup>2</sup>	20.91	19.81	<sup>2</sup>	<sup>2</sup>
3,000,000	16	2.18	<sup>2</sup>	7.45	6.21	8.75
	32	3.09	<sup>2</sup>	8.06	10.84	9.82
	160	11.31	11.62	12.39	<sup>2</sup>	34.08
	400	<sup>2</sup>	14.73	20.28	<sup>2</sup>	<sup>2</sup>
5,000,000	16	1.85	<sup>2</sup>	7.75	4.64	8.42
	32	2.48	<sup>2</sup>	8.06	8.66	9.44
	160	9.60	11.15	12.09	37.47	33.30
	400	<sup>2</sup>	16.72	19.51	<sup>2</sup>	<sup>2</sup>

<sup>1</sup> These costs were taken from Urban Research and Development Corporation (1980) and are adjusted to 2003 dollars.

<sup>2</sup> Indicates not competitive economically.

### Section III

#### Habitat Development

5.11 Definition and Application. Habitat development refers to the establishment and management of relatively stable and biologically productive plant and animal habitats (Smith 1978). The use of dredged material for habitat development offers a placement technique that is an attractive and feasible alternative to more conventional placement options. Various habitat development alternatives and their applicability to placement operations and sites are discussed in this section. Within any habitat, several distinct biological communities may occur. For example, the development of a dredged material island may involve a wide variety of habitats (Figure 5-8). Four general habitats are suitable for establishment on dredged material:

a. **Wetland.** Wetland habitat is a very broad category of periodically inundated communities, characterized by vegetation that survives in wet (hydric) soils. These are most commonly tidal freshwater and saltwater marshes, relatively permanently inundated freshwater marshes, bottomland hardwoods, freshwater swamps, and freshwater riverine and lake habitats.

31 Jul 15

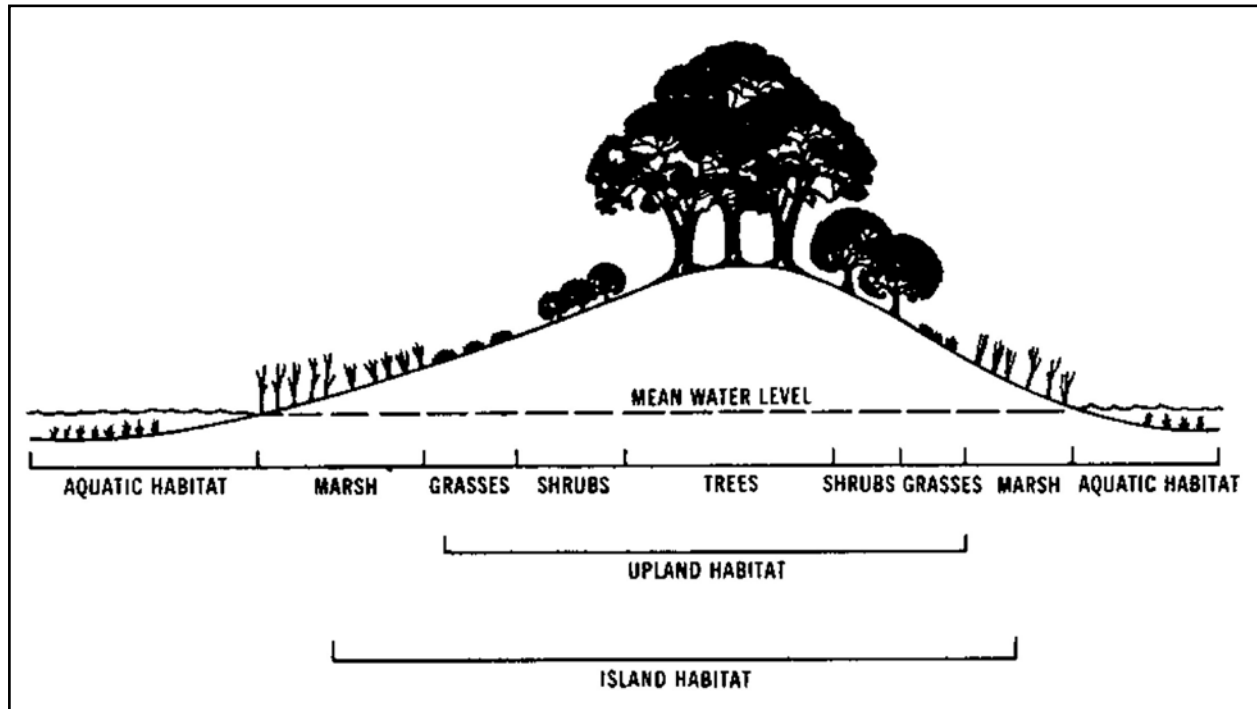

Figure 5-8. Hypothetical Site Illustrating the Potential Diversity of Habitat Types that may be Developed at a Dredged Material Placement Site

b. Upland. Upland habitat includes a very broad category of terrestrial communities, characterized by vegetation not normally subject to inundation. Types may range from bare ground to mature forest.

c. Aquatic. Aquatic habitats are typical submerged habitats extending from near sea, river, or lake level down several feet. Examples are tidal flats, oyster beds, seagrass meadows, fishing reefs, clam flats, and freshwater aquatic plant beds.

d. Island. Islands are upland and/or high zone wetland habitats distinguished by their isolation and particular uses, and completely surrounded by water or wetlands.

These concepts and their implementation are discussed in detail in Environmental Laboratory (1978); Hunt et al. (1978); Lunz, Diaz, and Cole (1978); Soots and Landin (1978); Landin, Webb, and Knutson (1989); Herbich (1992); NRC (1994); and Landin (1997a).

5.12 Case Studies of Selected Habitat Development Sites. Numerous examples of habitat development using dredged material substrates exist. Four are presented here to show the diversity of such sites.

#### 5.12.1 Buttermilk Sound salt marsh.

5.12.1.1 Buttermilk Sound, a 2 ha intertidal island marsh located in the Altamaha River, GA, was restored by plantings during 1975 on a sandy, infertile dredged material island that had not revegetated since deposition of material a number of years ago. Success of the original



plantings was related to the period of tidal inundation and type of propagule. Sprigs were more successful than seeds, and smooth cordgrass was the most successful species planted (Environmental Laboratory 1978; Landin, Webb, and Knutson 1989).

5.12.1.2 From the outset, the Buttermilk Sound marsh site has been very successful (Figure 5-9). Since 1979, it has been visually indistinguishable from natural reference marshes. Although tidal scouring initially washed out plantings and eroded the lower part of the intertidal zone, the site quickly stabilized. The established plant community has trapped large amounts of fine material, resulting in a thick layer of silt that now covers the original substrate. Smooth cordgrass dominates the entire lower two-thirds of the intertidal zone. Swards of big cordgrass and saltmeadow cordgrass remain at the middle intertidal zone elevations where they had been planted. The Buttermilk Sound site differs from nearby natural marshes by possessing greater plant species diversity at lower elevations. This probably is due to plant species that were introduced in zones lower than those at which they would naturally occur. Aboveground biomass is similar to natural marshes, but belowground biomass was lower for approximately 10 years, when biomass reached that of the older reference marshes. Wildlife use of the marsh is greater than in the natural marshes in all respects, including white-tailed deer, alligators, clapper rails, tern nesting, and migratory shorebird and waterbird use (Newling and Landin 1985; Landin, Webb, and Knutson 1989).



Figure 5-9. A Clapper Rail Running Through the Planted Dredged Material Salt Marsh at Buttermilk Sound, Altamaha River, GA, in 1985

31 Jul 15

5.12.1.3 The Buttermilk Sound site continues to represent one of the most successful small marshes built by the USACE. It appears to be very stable, and coverage and density of the marsh area, especially in the upper marsh zone, continue to increase to the extent that only one bare sandy spot remains on the entire island. This spot was not shaved down from the original elevation to an intertidal zone and, therefore, has been very slow to vegetate. It provides nesting habitat for black skimmers and terns.

#### 5.12.2 Salt Pond 3 salt marsh.

5.12.2.1 Salt Pond 3, a marsh site in South San Francisco Bay, California, was established on a portion of a 40 ha saltwater evaporation pond that was partially filled hydraulically with clayey dredged material in 1972. It is the only non-island habitat development site built by the USACE in its early research studies and programs. Plantings of Pacific cordgrass and pickleweeds were established during 1975-77. Cordgrass sprigs successfully colonized the lower two thirds of the intertidal zone, and pickleweed rapidly and naturally colonized the upper one-third (Newling and Landin 1985; Landin, Webb, and Knutson 1989, Landin 1990) (Figure 5-10).



Figure 5-10. Salt Pond 3 Habitat Development Field Site, South San Francisco Bay, CA, in 1980

5.12.2.2 The plantings maintained themselves and have spread slowly into adjacent unvegetated areas. Production was initially somewhat less than in nearby natural marshes, perhaps due to the relatively early stage of site succession, but it changed rapidly as the site trapped sediment to become dominated by pickleweeds, with only narrow fringes of cordgrass (Landin 1990). The cordgrass and pickleweed zones appear visually equivalent to natural marshes, and the entire 40 ha has become densely vegetated (Newling and Landin 1985; Landin, Webb, and Knutson 1989; NRC 1994).

5.12.2.3 Wildlife use is predominantly by birds, especially shorebirds that feed along the channel, and terns and other waterbirds. Peregrine falcons and other raptors frequent the area and feed on songbirds and rodents in the upper marsh zone. The site appears to be stable, and it survived the excessive El Nino rainfalls and severe storms that have pounded the West Coast from 1983 to the present without apparent damage. The rainfall actually seemed to improve the appearance of the marsh by increasing growth in the upper marsh zone. This site was compared to three natural reference salt marshes in the area, and growth and reproduction, as well as wild-life utilization, compared favorably over time.

5.12.2.4 The salt pond dike at this site was breached, and an intertidal channel formed to allow tidal access into the marsh. Over time, this breach has widened, and the dike protecting the site has completely eroded away, leaving the marsh fully exposed to the winds and waves of San Francisco Bay. Since the dike failed in the mid-1990s, the marsh has begun to erode at its frontal edges.

### 5.12.3 Gaillard Island confined placement facility.

5.12.3.1 Gaillard Island, a diked placement island in lower Mobile Bay, AL (Figure 5-11), was built by the Mobile District in 1981. This large, triangular-shaped island is being filled with material from the main shipping channel, and its gently sloped dike is primarily silty clay. Waves come into the island dike from all three sides, and erosion is a continuing problem. Beginning in 1981, smooth cordgrass was planted on the northwest dike behind temporary breakwaters made of floating and fixed tires. Surviving plantings from 1981 grew and spread behind the breakwater, and more plants were set between 1982 and 1986 with more breakwater designs and tests. Many of these were thriving into the 1990s in spite of several severe hurricanes hitting the area (Allen, Webb, and Shirley 1983; Landin 1986b; NRC 1994). Plantings in 1983 through 1986 were coupled primarily with tests of several filter materials and tire configurations as well as burlap rolls, different size propagules, and various placements in the intertidal zone. By 1995, the plantings had spread as far as they could into the bay by trapping sediment, and they had begun to recede in several areas along the dike. Brackish marsh species, such as saltmarsh bulrush and American threesquare, colonized behind the cordgrass and is thriving.

5.12.3.2 On the upland portion of the dike, aerially seeded Bermuda grass dominates, and it has effectively stabilized large portions of the dike. Diversity of invading plant species has increased, and this colonization process is expected to continue. Plant succession is already progressing, as areas that were weedy annuals in 1982 are now perennial grasses and small trees and shrubs capable of supporting wading bird nests. Species diversity and populations of both plants and animals has increased with each seasonal data collection period for over 12 years; these were documented from 1981 through 1987 by the U.S. Army Engineer Waterways Experiment Station (WES; now the U.S. Army Engineer Research and Development Center [ERDC]) and by the Alabama Department of Natural Resources since that time.



Figure 5-11. Gaillard Island Habitat Development Field Site, Lower Mobile Bay, AL, in 1984

5.12.3.3 Over 35 bird species, including 27 species of colonial waterbirds, are now nesting on the Gaillard Island. In 1984, 1985, and 1986 the birds numbered approximately 16,000 each year; numbers have stabilized at approximately 25,000 nesting annually. Laughing gulls dominated the nesting areas; however, large numbers of seven tern species, black-necked stilts, and black skimmers nested with much success. Muskrats colonized the island in late 1985; land birds nested there for the first time in 1984. Brown pelicans are nesting on the island, and 1983 marked the first recorded nesting for the species in Alabama in this century. In 1983, two chicks fledged from a single successful nest. In the 1984 summer survey, nests had increased to eight; 133 active nests were observed in 1985. In 1986 there were over 200 active nests by May, and more were being built. In the late 1990s there were five brown pelican colonies on the island. In addition, large numbers of nonbreeding white and brown pelicans are living there year-round (Landin 1986b; Landin, Webb, and Knutson 1989; Landin 1997c).

#### 5.12.4 Bolivar Peninsula upland and wetland site.

5.12.4.1 The Bolivar Peninsula field site, located on Goat Island in eastern Galveston Bay, TX, includes both marsh and upland planted areas. The original site is 8 ha of sandy dredged material, protected by a sand-filled geotextile bag/tube breakwater and an animal enclosure fence. It was built by the USACE and planted in 1974-1975. Both smooth and saltmeadow cordgrasses established well on this site (Figure 5-12). In the upland area, shrubs, trees, and

upland grasses initially established well, but invasion by other species eventually crowded them out (Allen, Webb, and Shirley 1983; Landin, Webb, and Knutson 1989). Since initial establishment, smooth cordgrass has spread throughout the lower tidal zone and dominates the site (Landin 1998b). The saltmeadow cordgrass has spread throughout the upper intertidal zone and into the upland section of the site. Saltgrass and pickleweeds invaded the same zone (Allen, Webb, and Shirley 1983) and continue to survive on the site.



Figure 5-12. Bolivar Peninsula Habitat Development Field Site, Galveston Bay, TX

5.12.4.2 Oysters had densely colonized the breakwater and intertidal area by 1982 and now help serve as a breakwater for the marsh (Davis and Landin 1997). Data through the 1990s indicated that the site would not have successfully survived the 42 km (26 mi) wind fetch if the breakwater had not survived. The site has also been heavily colonized by fiddler and blue crabs and has much fish use during high tide. Wildlife use is quite good; large numbers of sea and wading birds use the site. Small mammals live inside the fence that was once built to exclude them due to the need to collect vegetation data without grazers, and a number of ground-nesting birds use the site. By 1983 conversion of the upland zone from prairie grasses and woody plants to high marsh plants was complete. Cover on the site is dense and, unless it becomes heavily grazed by ranging feral goats on the island, it should remain in that condition. Clapper rail use is also quite heavy (Landin 1998b).



31 Jul 15

5.12.4.3 In addition to the three natural reference sites originally compared to the Bolivar Peninsula site from 1974 to 1980, four adjacent dredged material sites are now being compared on Goat Island: the old site planted in 1974-75; a deposit of sand dredged material (1982) to the west of the old site that was planted to test two breakwater designs built of low-cost materials; a second deposit of sand dredged material (1982) on the east side of the old site that serves as a control; and a part of the old site that was covered with an application of sandy dredged material in January 1986. Part of the original planting was deliberately covered with dredged material to determine the impacts of smothering and to determine how rapidly a salt marsh could recover from such disturbance. By 1994, the smothered site had completely recovered to its original salt-marsh vegetation. The smothered area was also compared to a site in East Matagorda Bay where silty dredged material was placed in August 1986 over existing high marsh. That site was slower to recover due to the depth of material and the fine-grained sediment but it, too, has recovered as high marsh. Data have been collected on these sites for over 25 years (Landin 1997d), and general observations will continue.

5.12.4.4 The Bolivar Peninsula site survived a direct hit by three hurricanes in 1983, 1986, and 1993. The only noticeable change was the washing away of the protective fence in the bay in front of the site. All of the natural marshes with which it was compared were changed by washouts of pockets of marsh, creating open-water pockets. These types of washouts did not occur on the field site. The data from these sites have been used to plan and design beneficial use marshes in Galveston Bay as part of the Houston Ship Channel Deepening and Widening Project, now underway. At the first of these, Atkinson Island, a large 60-year-old dredged material island in the upper channel, a salt marsh was constructed in a cove on dredged material and protected by a berm and geotextile breakwater in 1994. Initial data showed the site to be very successful (Davis and Landin 1997; Landin 1998a). Because it was fronted by large geotextile bags to protect it from wind fetch, the bogs colonized with oysters, and the salt marsh was thriving in 2000.

5.13 Habitat Development Selection Process. The diversity of biological communities indicates the potential diversity of alternatives available under habitat development. This wide range of options usually makes using quantitative measures for selecting specific alternatives impractical; consequently, selecting a given habitat development alternative is likely to be highly judgmental. The best determination can be made by a combination of local biological and engineering expertise and public opinion. Guidelines for the evaluation of individual habitat development situations are summarized below.

#### 5.13.1 Conditions favoring habitat development.

5.13.1.1 The selection of habitat development as a placement alternative is competitive with other placement options and types of beneficial uses when one or more of the following conditions exists:

- a. Public/agency opinion strongly opposes other alternatives.
- b. Recognized habitat needs exist.

- c. Enhancement measures on existing placement sites are identified.
- d. Feasibility has been demonstrated locally.
- e. Stability of dredged material deposits is desired.
- f. Habitat development is economically feasible.
- g. Extensive quantities of dredged material are available.

Since placement alternatives are often severely limited and constrained by public opinion and/or agency regulations, with constraints on open-water and other sites, development of placement sites as habitat is an attractive alternative and, in many cases, has strong public appeal. The needs for restoration or mitigation or for additional habitat may strongly influence the selection of the habitat development alternative. This is particularly applicable in areas where similar habitat of considerable value or of public concern has been lost through natural processes, as at Pointe Mouillee in Lake Erie, or through construction activities, as at Chevron Marsh in Pascagoula, MS (Landin 1998a). Habitat development may be used as an enhancement measure to improve the acceptance of a placement technique. For example, seagrass may be planted on submerged dredged material or wildlife food plant established on upland confined placement sites. Habitat development has considerable potential as a low-cost mitigation procedure and may be used to offset environmental impacts incurred in dredging and placement.

5.13.1.2 Over 30 years of project work and research data have proven that the concept of habitat development is more apt to be viewed as a feasible alternative if it has been successfully demonstrated locally. The existence of even a pilot-scale project in a given locale will offset the uncertainties often present in the perception by the public and resource agencies of an experimental or unproven technique. The vegetation cover provided by most undiked habitat alternatives will generally stabilize dredged material and prevent its return to the waterway. In many instances, this aspect will reduce the amount of future maintenance dredging necessary at a given site and result in a positive environmental and economic impact.

5.13.1.3 The economic feasibility of habitat development should be considered in the context of long-term benefits. Biologically productive habitats have varied but unquestionable value (for example, sport and commercial fisheries) and are relatively stable features. Consequently, habitat development may be considered a placement option with long-term economic benefits that can be applied against additional costs that may be incurred in its implementation. Habitat development may be particularly economically competitive in situations where it is possible to take advantage of natural conditions or where minor modifications to existing methods would produce desirable biological communities. For example, the existence of a low-energy, shallow-water site adjacent to an area to be dredged may provide an ideal marsh development site and require almost no expenditure beyond that associated with open-water placement. Actual dollar values assigned to habitat development has been a controversial topic of discussion among scientists for decades. All agree that the work is beneficial and that such sites are highly valuable, but none agree on valuation estimates.

5.13.2 Guidelines. Habitat development presents several options ranging from establishment of upland communities to the development of seagrass meadows. A broad procedural guide to the selection of the habitat development alternative is given in Figure 5-13 and in Landin (1993) and NRC (1994). The beneficial use planner should ignore categories unrelated to the particular problem and may want to add key site specifications.

5.13.2.1 Preliminary assessment. The initial consideration of habitat development as a placement alternative should include a preliminary assessment of feasibility, which involves judgment based on available data. A determination that habitat development is not initially feasible should be based on compelling negative evidence and not merely on a lack of information or specific precedents. In the absence of such negative evidence, one should proceed to the detailed evaluation of feasibility. Factors may arise at several stages in the evaluation that would lead to a determination of infeasibility. Should that occur, other placement alternatives would be reconsidered.

a. The detailed evaluation of feasibility includes six major categories, beginning with a characterization of the dredged material and arranged generally in the order of need for acquisition of information. In a characterization of the dredged material, the physical, chemical, and engineering characteristics of the material to be dredged should be determined. These properties will help define the general considerations of site selection.

b. Site selection should be based on an adequate knowledge of energy conditions, foundation characteristics, salinity, tidal influences, and bottom topography. Energy conditions will largely influence the feasibility of establishing a stable substrate or the necessity of protection structures. Foundation characteristics will determine the ability of a given site to support construction activities or structures. Salinity and tidal influences will dictate the plant species composition. A more detailed analysis of these factors will be necessary later for detailed design purposes if the habitat development alternative is selected, but even in this early phase, some field sampling may be necessary if general information is not available.

c. Engineering considerations at this stage are largely confined to preliminary designs and an assessment of equipment needs and availability. Details such as scheduling to meet critical environmental dates (for example, spring or summer planting times) and the identification of dredged material transport distances provide useful planning data. In many projects, the pivotal determination of engineering feasibility or infeasibility can be made at this stage. One of the most undercollected data items is number and analysis of core samples from the site to be dredged, thereby allowing misinterpretation of the final percentages of fines or sands at the placement site. The danger in this is that it may allow the consolidation ratio, and therefore the final elevation, to be miscalculated.



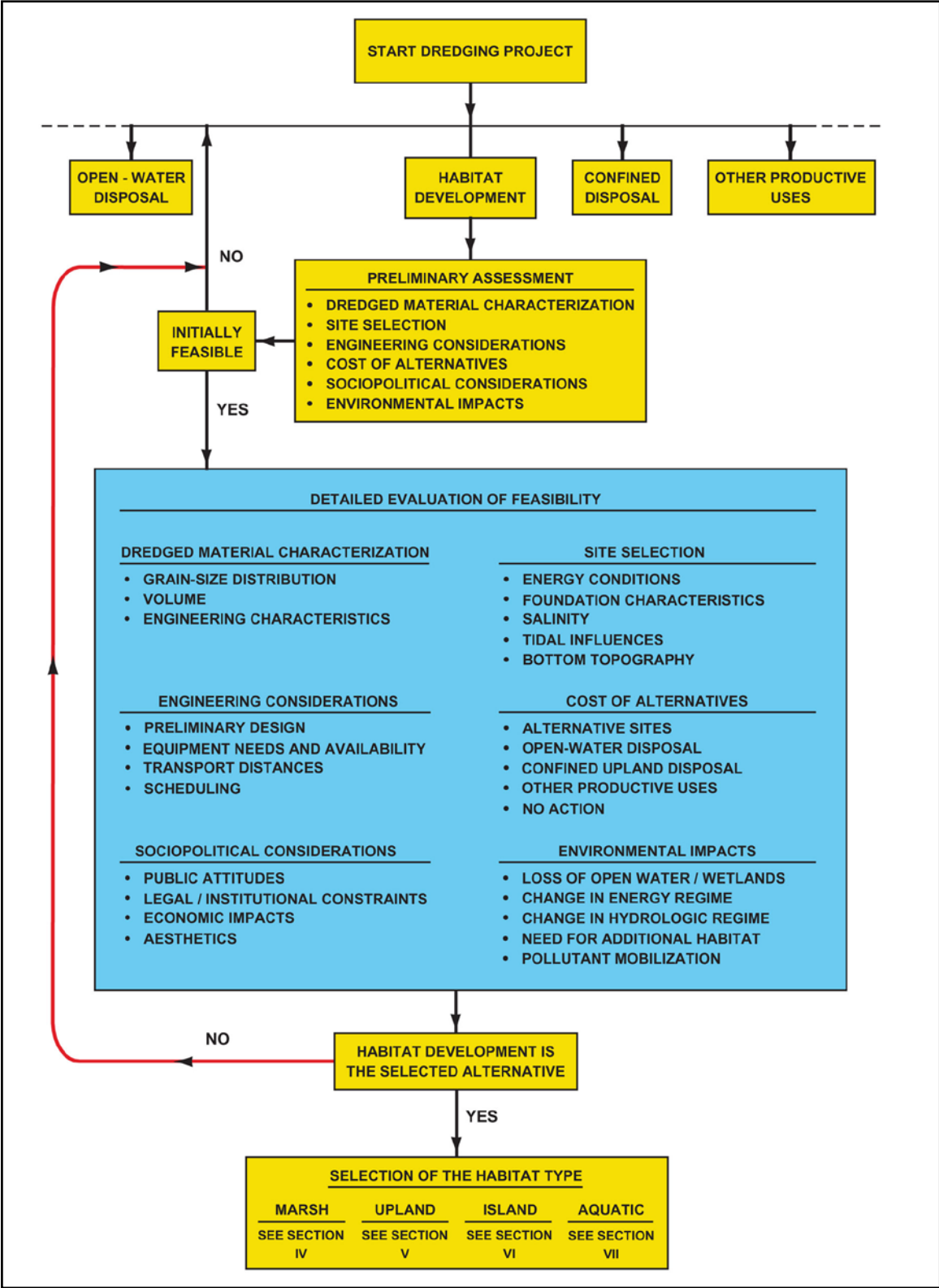

Figure 5-13. Procedural Guidelines for the Delection of Various Habitat Development Alternatives Using Dredged Material

d. Evaluation of the cost of alternative placement methods is the next essential step. In a number of USACE Districts, this is the first step in assessment. Detailed economic analyses must await the further development of design criteria; however, a general cost comparison of the various alternative sites should be possible at the completion of the preliminary assessment of feasibility. This is another critical step because considerable time and effort can be spared by defining the economic limits that the project must satisfy to remain competitive with other alternatives.

e. Of the sociopolitical considerations, public attitudes, legal and institutional constraints, and costs are most likely to prove limiting. Negative public attitudes generally occur when the community views the proposed habitat as a threat to established values. Legal and institutional constraints frequently arise when there are unanswered questions of ownership and access or when local interests have designated the site for an alternative future use. Direct economic impacts may be identified if the habitat to be developed may alter important shellfishing or recreational areas or block a water view. Beneficial use projects may be stopped due to lack of USACE funds and/or lack of funds from cost-sharing sponsors, now required under Federal law.

f. The environmental impact of most habitat development projects may be expressed as a loss of open-water habitat or wetland systems and changes in hydraulic and energy regimes. The impacts of these factors tend to be cumulative and are directly related to the perceived need for additional habitat. In general, the need for more habitat is considered more critical in areas that have lost or are losing considerable habitat of that type. Pollutant mobilization by plants growing on contaminated dredged material might be of concern, and its potential should be determined prior to habitat development.

5.13.2.2 Selection of habitat development as an alternative. Upon completion of the preliminary assessment of feasibility, a determination can be made whether habitat development is applicable. If habitat development is a selected alternative, a decision regarding the type or types of habitats to be developed must be made. This decision is largely judgmental, but in general, site peculiarities do not present more than one or two logical options. Specific advantages and disadvantages likely to be encountered are evaluated, and items of particular concern during early feasibility determinations are highlighted in the following sections of this manual: Section IV, "Wetland Habitats"; Section V, "Upland Habitats"; Section VI, "Island Habitats"; and Section VII, "Aquatic Habitats."

#### Section IV

#### Wetland Habitats

5.14 Marshes. Marshes are considered to be any community of grasses or herbs that experience periodic or permanent inundation. Typically, these are intertidal freshwater or saltwater marshes and periodically inundated freshwater marshes. Marshes are recognized as extremely valuable natural systems and are accorded importance in food and detrital production, fish and wildlife cover, nutrient cycling, erosion control, floodwater retention, groundwater recharge, and aesthetics. Marsh values are highly site-specific and must be examined in terms of such variables

as species composition, location, and extent, which in turn influence their impact upon a given ecosystem.

5.15 Marsh Development Considerations. Accurate techniques have been developed to estimate costs and to design, construct, maintain, and monitor man-made marsh systems (Allen, Webb, and Shirley 1983; Environmental Laboratory 1978; Landin 1984, 1992a, 1993, 1998b; Newling and Landin 1985; Landin, Webb, and Knutson 1989; NRC 1994; King and Constanza 1994; Brooke et al. 2000; Landin et al. 1999). Methods are available to predict the impact of the alternatives on the environment and to describe the value of the proposed resource prior to its selection.

5.15.1 Advantages. Several advantages have been found in marsh development as a placement alternative:

- a. Considerable public appeal.
- b. Creation of desirable biological communities.
- c. Considerable potential for enhancement or mitigation.
- d. Frequently a low-cost option.
- e. Useful for erosion control.

Wetland and marsh development is a placement alternative that can generate strong public appeal and has the potential of gaining wide acceptance when some other techniques cannot. The restored or created habitat has biological values, especially restoration, that are readily identified and accepted by many in the academic, governmental, and private sectors. A created wetland is one in which all factors (hydrology, geomorphology, vegetation, and energy protection) must be provided at a site where no wetland has ever existed. A restored wetland is one in which one or more of the critical factors are still present and a wetland existed on that site before. It is much less expensive, with a much higher degree of success, to restore a wetland than to create one. Application of these principles and factors requires an understanding of local needs and perceptions and the effective limits of the value of these ecosystems. The potential of this alternative to replace or improve marsh habitats lost through dredged material placement or other activities is frequently overlooked. Marsh development techniques are sufficiently advanced to design and construct productive systems with a high degree of confidence even in moderate wave energy environments. For example, salt marshes have been established at Bolivar Peninsula and Atkinson Island in Texas; Gaillard Island in Alabama; Barren Island and Kenilworth Marsh, Eastern Neck National Wildlife Refuge, and other locations in the Chesapeake Bay; and a number of other locations behind temporary breakwaters in moderate energy areas. These habitats can often be developed with very little increase in cost above normal project operation, a fact attested to by hundreds of marshes that have been inadvertently established on dredged material and by the more than 1,000 marshes that have been purposely created using dredged material substrates and mitigation for dredge and fill in U.S. waterways over the past century of dredging the Nation's navigation channels.

5.15.2 Disadvantages. Several problems are likely to be encountered in marsh development:

- a. Unavailability of appropriate sites.
- b. Loss of other habitats.
- c. Possible release of any contaminants.
- d. Loss of site for subsequent placement of dredged material.

By far the most difficult initial aspect of the application of marsh development is the location of suitable sites. Over time, the loss of the site for subsequent placement increases significantly. Low-energy, shallow-water sites offer the most potential; however, cost factors become significant if long transport distances are necessary to reach low-energy sites. Temporary protective structures may be required if low-energy sites cannot be located. These have been successful at several Gulf coast sites where moderate wave energy occurs (Allen et al. 1978; Allen, Webb, and Shirley 1983). Marsh development can frequently mean the replacement of one desirable habitat with another, and this is the source of most opposition to this alternative. However, if low-productivity sites that were previously marsh can be restored using dredged material, opposition is greatly reduced. There are few reliable methods for comparing the various losses and gains associated with this habitat conversion; consequently, determining the relative impact may best be made on the basis of the professional opinion of local authorities. Although studies have shown that contaminant uptake from soil in marsh environments is minimal, the planner should remain alert that the potential exists with highly contaminated sediment use. Development of a marsh at a given site can prevent the subsequent use of that area as a placement site. In many instances, additional development on that site would be prevented by state and Federal resource agencies. Exceptions may occur in areas of severe erosion or subsidence such as coastal Louisiana, or where previous placement created a low marsh and subsequent placement would create a higher marsh with a different wetland plant community.

5.15.3 Maintenance. Dredged material marshes should be designed to be relatively maintenance free (Landin 1993, 1995). The degree of maintenance depends largely on the energy conditions at the site, a factor that should be included in the cost analysis of the project. No maintenance may be required to protect the new marsh in low-energy situations. In most areas of moderate to somewhat higher energy conditions, protection may be required only until the marsh has a chance to mature. In those areas, protective structures may be designed for a relatively short life of 3-10 years with no additional maintenance required. In high-energy situations and long wind fetches, perpetuation of the marsh may require planned periodic maintenance of protective structures and possibly periodic replanting. This is true whether the site is coastal, lake, or riverine.

## 5.16 Guidelines for Marsh Development.

5.16.1 Selection of wetland type. If marsh development is the beneficial use alternative selected, it is necessary to select the most appropriate wetland type (Figure 5-14). In most situations, the selection of a wetland type is largely predetermined by overriding environmental

conditions such as tidal range, salinity, or flood conditions. Most marsh development projects, simply because of the nature of dredged material placement and the formation of drainage patterns, contain elements of shallow and deep marsh (fresh water) or high and low marsh (salt water).

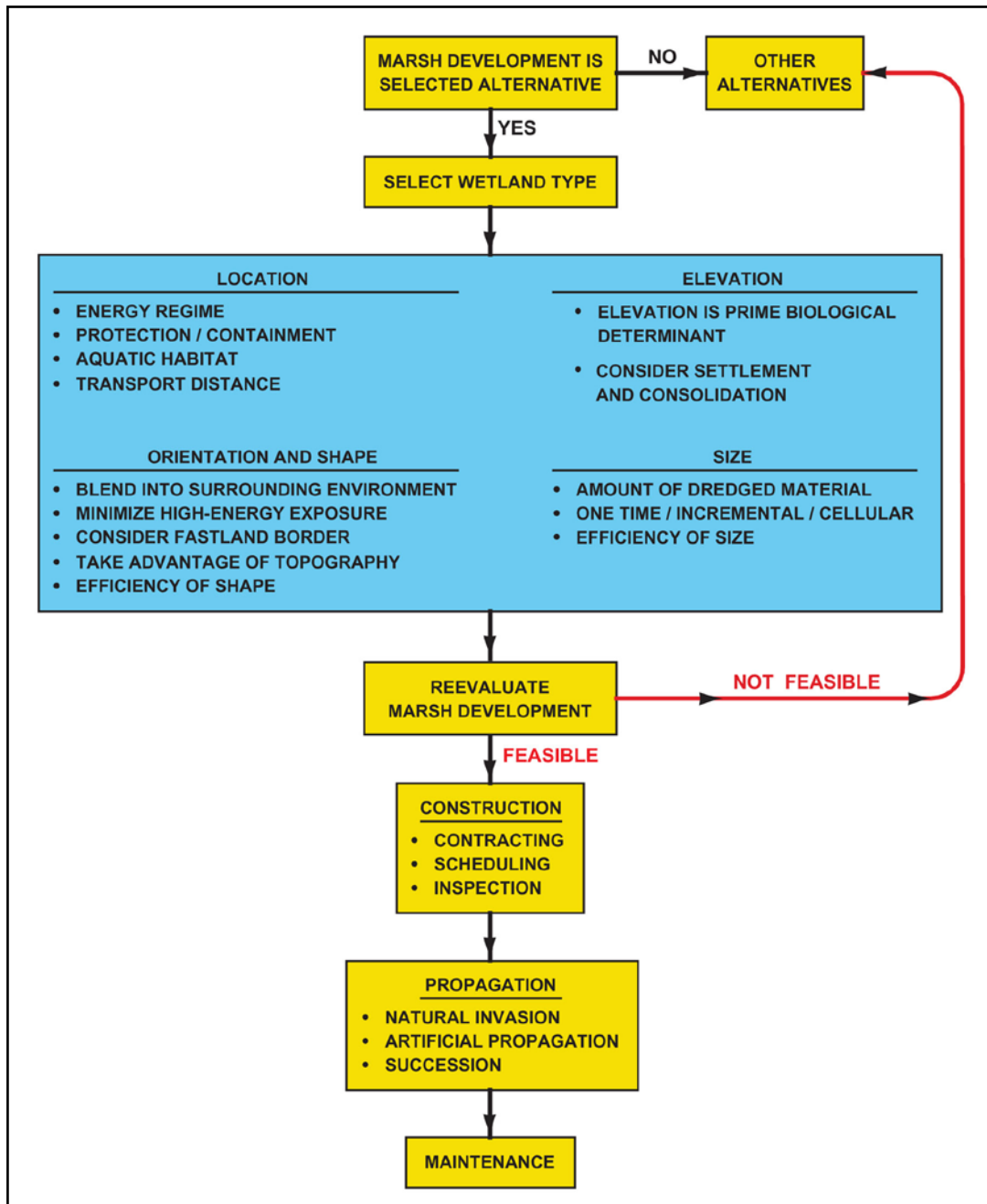

Figure 5-14. Procedural Guidelines for the Selection of Various Marsh and Wetland Habitat Development Alternatives

5.16.2 Design of marsh habitat. The detailed engineering design of the marsh habitat is separated into four parts: location, elevation, orientation and shape, and size. The design should maintain the goals of placement of dredged material through the development of a desirable biological community, using the most cost-efficient methods and causing a minimum of environmental perturbation. Engineering and biological designs of marshes have been researched and long-term field tested by ERDC (Environmental Laboratory 1978; Newling and Landin 1985; Landin, Webb, and Knutson 1989; Landin 1993 and 1997b; NRC 1994) at over 35 locations in U.S. waterways for more than 15 years. Numerous other man-made wetlands using dredged material and mitigation for dredge and fill have been studied and monitored for shorter periods of time.

5.16.2.1 Location. The location of the new marsh may be the most important decision in marsh development. Low-energy areas are best suited for marsh development, and sandy dredged material has been found to be the ideal substrate. Departure from these conditions requires a careful evaluation of the need for structural protection and containment. High wave or current energies may prevent the formation of a stable substrate and the establishment of vegetation, making various forms of protective structures or mechanisms necessary (Allen, Webb, and Shirley 1983; Davis and Landin 1997; Chasten et al. 1993). Another major consideration in protection and containment is the grain-size distribution. Hydraulically placed clay or silt usually requires temporary or permanent containment, regardless of wave or current conditions. Containment is generally required to hold fine-grained material within a prescribed area. Silt under very low energy situations may require no containment or protection; however, in moderate energies it is essential. Sand that would require no protection under low-energy situations may require some protection under moderate wave energy. Obviously, a wide range of conditions exists. It should be remembered that those areas best suited for marsh development (shallow, low energy) are also likely to be biologically productive. Particular efforts should be made to avoid unusually productive areas, such as seagrass meadows, clam flats, and oyster beds. In general, the further dredged material must be moved, the greater the cost in marsh development. The availability of suitable equipment may also influence the feasibility of distant placement. Therefore, attention should be given to locating the placement site as near the dredging operation as possible.

5.16.2.2 Elevation. Final elevation of the marsh substrate is determined largely by settlement and consolidation and is the most critical of the operational considerations as it dictates both the amount of material placed and the biological productivity of the habitat established. Techniques are available to predict the final stable elevation of a given volume of dredged material placed in a confined intertidal situation (Environmental Laboratory 1978; Hayes et al. 2000). Salt marshes are generally most productive within the upper third of the tidal range while freshwater marshes should generally be flooded to a depth of not more than 0.6 m (2 ft). Determination of final elevation and biological benchmarks for vegetation is critical and should be based on precise knowledge of the elevational requirements of the plant community. Variation in topography produces habitat diversity and should be encouraged, provided that the majority of the area is within the desired elevation range. If achieving a desired elevation appears unlikely, incremental filling at a site may be possible, with a conservative estimate of the amount of material necessary to attain a given elevation. Should the final elevation still be too low, the difference can be made up in subsequent placement and add-ons. If one-time placement is

anticipated, it may be possible to overfill and rework the area to a lower elevation with earth-moving equipment, especially if the dredged material is sandy.

5.16.2.3 Orientation and shape. The orientation and shape of the new marsh largely determines its total cost, its efficiency as a placement site, and its effectiveness as a biological addition to the natural environment. The shape should minimize impact on drainage or current patterns in the area surrounding the placement site and allow it to blend into the surrounding environment. If high-energy forces are anticipated, the marsh should be shaped to minimize high-energy exposure. Such design reduces the threat of failure and the cost involved in providing protection. If available, a fastland border, such as a cove, island, dike field, peninsula, or breakwater, can serve as low-cost protection and minimize the length of otherwise necessary and costly containing or protective structures. Seeking such locations may greatly reduce costs. Atkinson Island marsh, built by the Port of Houston in 1994, is an excellent example of utilization of a cove as a man-made marsh restoration site (Swafford and Gorini 1994). An effort should be made to take advantage of bottom topography during the design of the new marsh. Placement sites are often not uniform in depth; if possible, protective structures should be located in shallow water or on a sand berm and the fill area in deep water to maximize the containment efficiency. If dikes are built from local material, it may be possible to deepen the placement area by locating borrow material within the dike area. Shape may also be a major cost determinant when diking is required. For a given area of protected marsh, a circle requires the minimum dike length. A rectangle increases dike length in proportion to its length-width ratio. For example, a rectangle ten times longer than wide requires a perimeter nearly twice that of a circle to contain the same area. In addition, angular designs often leave exposed points where dike failures can occur.

5.16.2.4 Size. The size of the placement area is a function of the amount of the material to be dredged and the volume of the placement area. Several filling options might affect size—including one-time, incremental, and cellular. One-time filling implies that a site is filled and marsh established within that operation, and that the area will not be used again for placement. In incremental filling it is recognized that the site will be used during the course of more than one dredging operation or season, and that the placement area will be considered full when a predetermined marsh elevation is attained. In cellular filling, a compartment of a prescribed placement area is filled to the desired elevation during each dredging project. Both incremental and cellular filling offer the efficiency of establishing a large placement site and using it over a period of years, thus avoiding costs of repetitive construction, design, and testing operations. A major difference between these two methods is that the cellular method provides a marsh substrate at the end of each season whereas many years may be required before incremental filling attains this goal. Cellular or incremental placement sites are generally larger than one-time placement sites, and this increase in size may offer a more cost-effective placement site.

5.16.3 Reevaluation and construction. A final reevaluation of the marsh development alternative should take place prior to construction. Marsh development contracting procedures may sometimes prove to be difficult because, although these projects are becoming more common, neither the contractors nor the USACE may have had much previous experience with marsh contracts. Pre-bid conferences to explain the intricacies of the project, as well as carefully detailed contract specifications, are strongly advised. Scheduling the dredging can prove to be

particularly important. To obtain maximum vegetative cover within the first year, it is necessary to have the dredged material in place and with a relatively stable surface elevation by the beginning of the growing season. Delays will affect the initial success of the project and may result in loss of nursery or seed stock, replanting costs, adverse public reaction, and unwanted erosion at the site. It cannot be overemphasized that careful inspection of the placement operation is essential, as the attainment of the prescribed elevation is critical, an aspect that may not be appreciated by the dredging contractor and crew or even the USACE dredging inspectors.

5.16.4 Vegetation establishment. Marsh plants can be propagated by natural invasion or artificial propagation. Natural colonization by wetland plants can be expected if the environmental requirements for a marsh community, including a source of propagules, are present at a site. In some cases, especially in freshwater marshes, natural invasion occurs on a site within a few months; in others, especially saltwater coastal areas, many years may be required. The process of marsh establishment will be accelerated on most sites by seeding or sprigging, which is generally considered essential in salt marshes of moderate- to high-wave conditions due to site exposure and harshness of conditions. Every effort should be made to ensure that species selected for artificial propagation represent a natural assemblage for a given area. Exotic or offsite species are generally be able to compete with natural invaders and are not encouraged. An exception may be an instance in which a species is selected for temporary cover or erosion control until natural invasion has colonized the site. For example, smooth cordgrass is planted in tropical Florida, with mangrove seed pods interspersed. The smooth cordgrass provides protection as a nurse crop for the mangrove seedlings until they become firmly established. The advantage of propagation by natural invasion is the low cost, and this may be a pivotal consideration in cost-borderline projects. Another exception is in Galveston Bay, TX, where smooth cordgrass has been victimized by a disease that renders most seeds sterile. The USDA Natural Resources Conservation Service (NRCS) has developed a disease-resistant strain of smooth cordgrass in Louisiana that is now being successfully planted in coastal Texas. The advantages of artificial propagation are more rapid surface stabilization and an immediate vegetation cover. Seven types of propagules are available for marsh vegetation establishment: seeds, rootstocks, rhizomes, tubers, cuttings, seedlings, and transplants (sprigs). By far the most commonly used in marsh establishment is transplanted sprigs.

5.16.4.1 Factors influencing design. The successful establishment of a planned marsh requires careful project design and implementation. Each site exhibits its own peculiarities and must be approached individually. In any marsh design, a number of site-specific factors are significant; the most important are salinity, tidal range, flood stages, soil texture, wave and wind action, contaminant tolerance, outside influences, and cost. It is important to note that four overall factors are crucial for wetland restoration or creation: adequate hydrology, geomorphology, hydrophytic vegetation, and protection from energy sources (Landin 1995; NRC 1994).

5.16.4.2 Protection. The new substrate must be protected either by location in a low-energy area or by placement of a protective structure, such as a permanent or temporary dike or breakwater (Figure 5-15) (Landin, Fowler, and Allen 1994). Low-energy areas are most commonly found in the lee of beaches, islands, and shoals; in shallow water where wave energies are dissipated; on the inside downstream side of riverbends; in embankments where marshes presently exist; within zones



of active deposition; and away from long fetch exposure, tidal channels, uncontrolled inlets, and headlands. Plants themselves may be used as a protection barrier if more erosion-resistant large transplants are planted on the outer fringes of the marsh, with or without the use of bioengineering materials such as fiber matting and geotextiles, with more susceptible but less expensive propagules such as rootstocks, tubers, and seeds in the interior and high marsh areas of the site. Young plants are particularly vulnerable to wildlife feeding and browsing. Herbivores such as Canada geese, muskrats, nutria, rabbits, goats, sheep, and cattle can and will rapidly destroy a newly planted marsh. Heavy grazing may even destroy well established and mature marsh communities. Potential animal depredation should be evaluated for each site and, in extreme cases, should be controlled by trapping or fencing. On some new marshes, placement of wire mesh over plantings to prevent goose grazing is essential until the marsh is well established.

5.16.4.3 Plant spacing. Plant spacing is highly site specific and is governed by the quality of the substrate, type of propagule, length of the growing season, and desired rapidity of plant cover. Generally, when transplants are used, parallel rows and spacings of 0.3-1 m (1-3.3 ft) are recommended to achieve relatively uniform cover by the end of the second growing season (Figure 5-16). Planting at about 1 m (3.2 ft) intervals is usually a good compromise between high costs and full cover. If the cost of transplants is a limiting factor, or if there is no compelling reason to attain full cover within a short time, then spacing may be greater than 1 m (3.2 ft). If the site is extremely unstable, subject to heavy wildlife pressures or physical stresses, or if aesthetics are an immediate concern, more dense plantings of 30 cm (12 in.) spacing may be desirable; or densely rooted marsh grass matting can be spread and anchored on a site. For example, if Canada geese are known to use the area heavily, the plants should be spaced closely to encourage the geese to limit their feeding to the edges of the new marsh. Transplants may be evenly or randomly spaced; even spacing is more efficient in use of machinery and labor. Other vegetative propagule types such as rootstocks, rhizomes, and smaller sprigs are handled similarly to transplants. However, since they grow much slower initially, these propagules should be spaced more closely. Intervals of 30 cm (12 in.) are recommended for rootstocks and rhizomes, and 30-45 cm (12-18 in.) for smaller sprigs.

5.16.4.4 Diversity. In general, a site planted in a variety of species over a topographic range, from deepwater to upland areas, is preferred. Exceptions to this are sites where physical stresses are particularly harsh or stabilization is critical (as on dike slopes), where only one species can tolerate the conditions, or where quick cover by a vigorous monoplanting, such as smooth cordgrass at low intertidal elevations, is needed. More typically, variation in site elevation with respect to water regime necessitates planting the dredged material with at least two species to obtain both high and low marsh. Species diversity can be used to achieve greater appeal to a more diverse group of wildlife, to enhance habitat for a target wildlife species, to control animal depredation by planting a high-value wildlife food species as a sacrifice, to better ensure site success, and to provide for long-range plant succession at the site by making available sources of several desirable species. Generally, marshes of about 20% mud flats, 30% vegetation cover, and 50% open, shallow water are most productive from an ecological standpoint and in overall fish and wildlife use. It may be necessary to establish the marsh first, then do any clearing that may be required for a wildlife enhancement objective; but such habitat diversity can often be accommodated with careful dredged material placement.



a. A Floating Tire Breakwater Installed at Gaillard Island, AL, to Protect Newly Planted Marsh from Moderate Water Energies; Floating Breakwaters must be Prevented from Breaking Loose into Open Water



b. Filling a Custom-Designed Geotextile Tube with Dredged Material in Chesapeake Bay, MD, for Erosion Control and Sediment Stabilization

Figure 5-15. Protective Structures for New Substrate



Figure 5-16. Transplants at Miller Sands Habitat Development Site, Planted on 1 m (3.3 ft) Centers, at the End of the First Growing Season

5.16.4.5 Plant species selection. The selection of plant species appropriate to the region, to the site, and to the project objectives is the first step toward vegetation establishment. Success of the project may hinge upon the species being planted, the propagule types used, and the use of the plant material by wildlife. The site planner be familiar with nearby marsh plant communities that occur on similar sites, noting the distribution and relative abundance of species within the stands. All species should be considered, both dominants and less common species. For example, smooth cordgrass, because of its large areal extent, has been considered the major marsh species in the eastern and Gulf coasts of the United States, but other species—such as black needlerush, saltgrass, saltmeadow cordgrass, big cordgrass, saltmarsh bulrush, river bulrush, cattails, and nutsedges—are also easily established and highly productive. Figures 5-17 through 5-20 show generalized profiles of major marsh plant associations for East and West Coast salt marshes, brackish marshes, and fresh lake, pond, and river marshes. Selection of a species or mixed group of species for planting at a particular site should be based upon project goals, location, climate and microclimate, tolerance, soil, plant growth habits, plant availability, maintenance requirements, and costs. If a project goal is to establish habitat for target wildlife species, any plant species known or suspected to be of use for cover, food, resting, or nesting for those species should be considered. If soil stabilization is a goal, species selection is influenced. If fish nursery utilization is the primary goal, shallow open water interspersed with emergent marsh is more desirable. Marsh plant species have varied capacities for stabilization. Their underground root structure, rate of growth, and season of growth are important; and species with a longer growth cycle—such as smooth cordgrass, saltmeadow cordgrass, cattails, tule, and black needlerush—are probably more effective at erosion control than ones such as big cordgrass, saltmarsh bulrush, and saltgrass with a seasonal cycle.

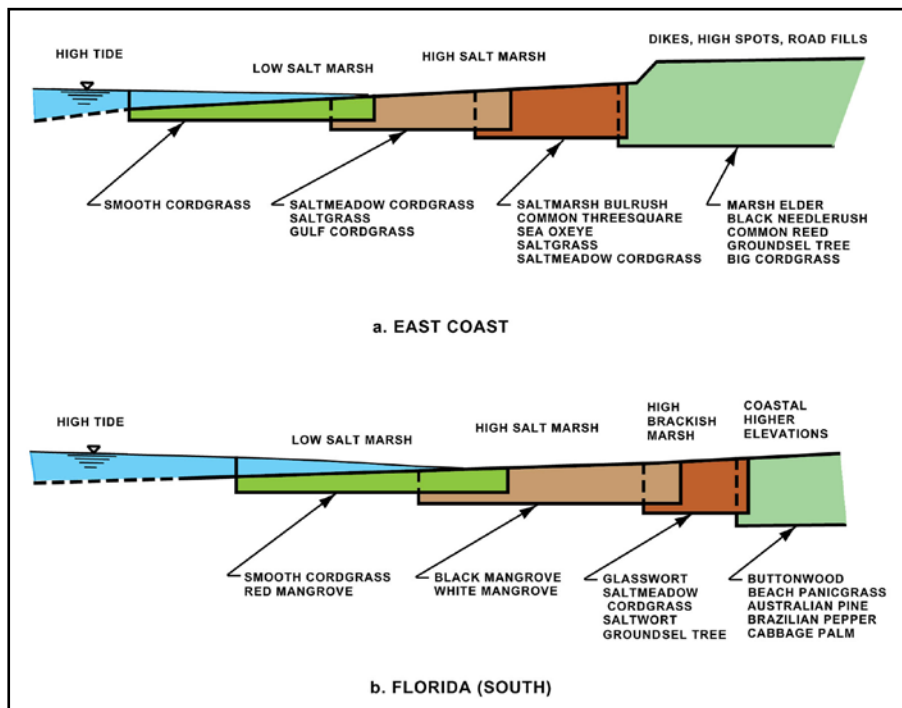

Figure 5-17. Sketches of Typical East Coast and Florida Tidal Marshes, Showing Plant Association and Usual Occurrence in the Marshes

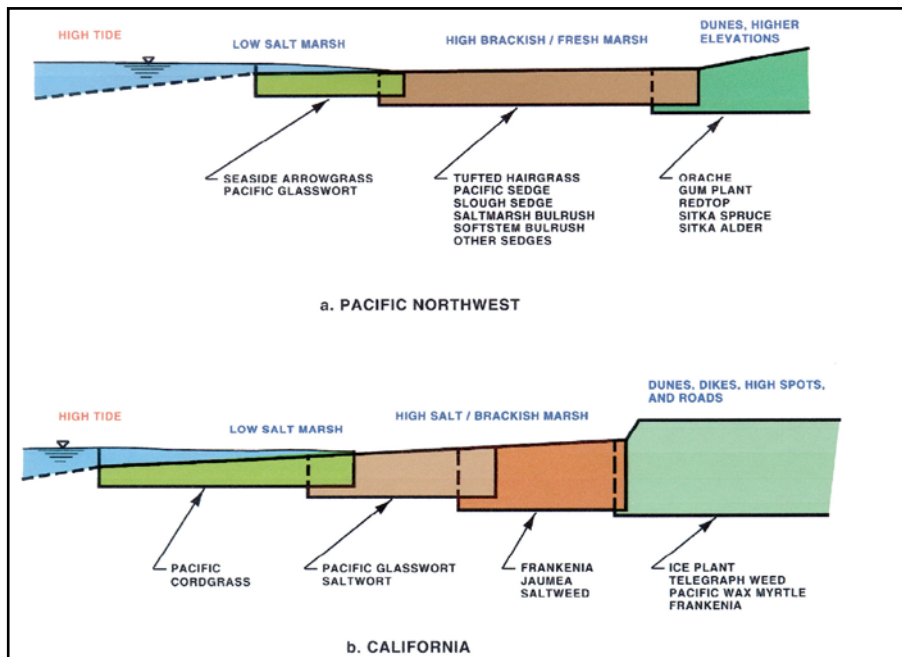

Figure 5-18. Sketches of Typical Pacific Northwest and California Coast Tidal Marshes, Showing Plant Associations and Usual Occurrence in the Marshes

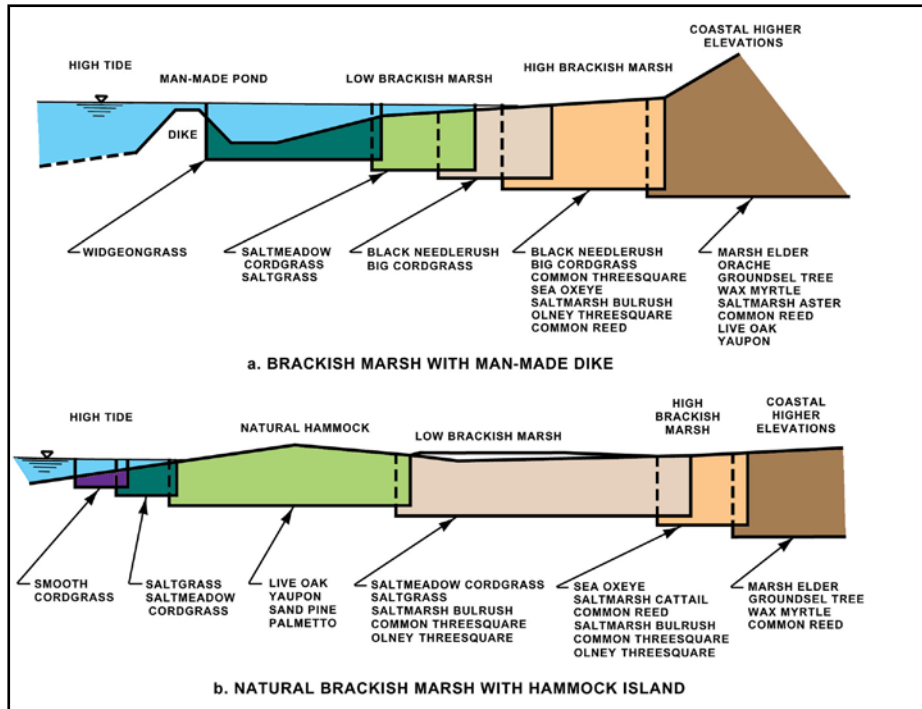

Figure 5-19. Sketches of Typical Brackish Marshes, Showing Plant Associations and Usual Occurrence in the Marshes

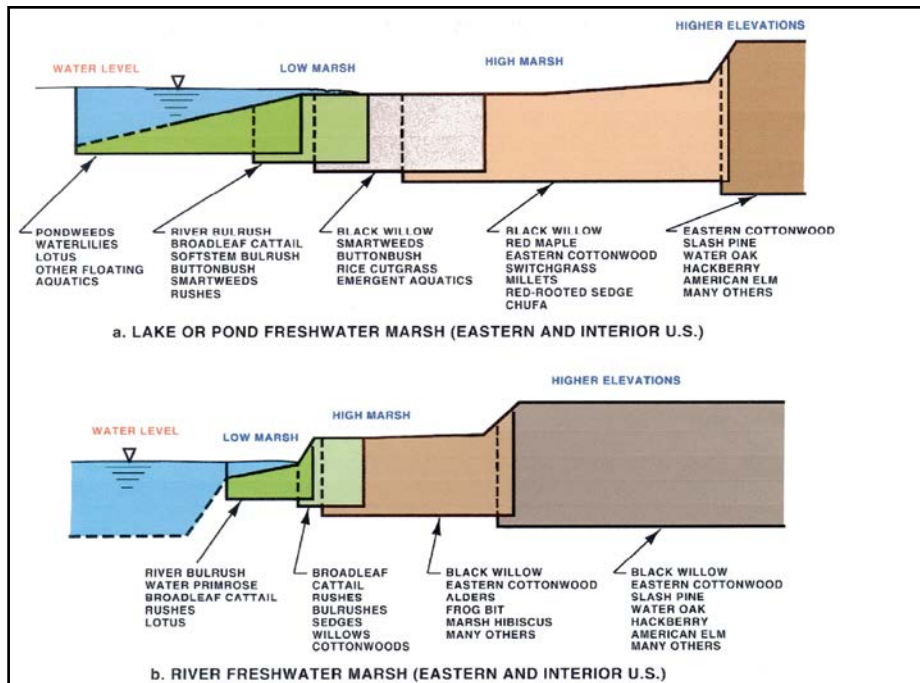

Figure 5-20. Sketches of Typical Lake or Pond and River Freshwater Marshes, Showing Plant Associations and Usual Occurrence in the Marshes

5.16.4.6 Propagule selection. Once species selection has been completed, more detailed consideration must be given to the type and availability of plant propagules, the amount of plant material needed to propagate a site, and the costs. The criteria for selection of propagule types are similar to the considerations used for selection of plant species: availability and costs, collection and handling ease, storage ease, planting ease, disease, urgency of need for vegetative cover, and site elevation.

5.16.4.7 Handling plant material and planting the site. These techniques will generally be applied by a USACE contractor. Specific handling and planting details for marsh vegetation are discussed in Environmental Laboratory (1978) and Landin (1978) for seeds and vegetative propagules such as transplant and rootstock. Appendix D, "Plant Materials for Beneficial Use Sites," provides information on 359 upland and 105 wetland plant species tested in U.S. waterways that may be planted on dredged material beneficial use sites.

5.16.4.8 Pilot propagation study. In a marsh development project where there are unknown factors such as seed or sprig collection and planting techniques, effects of animal depredation, rate of plant spread, heavy metal uptake, or lack of experience in similar projects, it is prudent to conduct a pilot study. A pilot project is particularly advisable if the project is a large and costly one. The main purpose of a pilot study is to determine whether the selection plant species and propagules will grow under conditions found on the site. The study can be conducted in less than a year, but the test species should be allowed to grow for one full season before conclusions are drawn. Such a project should be of sufficient size that it accurately reflects future operational difficulties. Each selected species should be tested against all site conditions, and it may be advisable to test more than one propagule type, propagation method, planting time, and plant spacing for each species. The size of the pilot study is limited only by the desired tests, the time available for such testing, and funding. A simple statistical design permits quantitative evaluation of the study where prediction of degree of success or failure can be made. The success of these plants can generally be evaluated by observation of survival. Test plots established should be evaluated on a regular basis to determine survival and growth, natural plant invasion, erosion, and animal depredation. Fixed-position photography and observations on a regular basis are also valuable tools in obtaining a good record of plant success, growth, or dieback.

5.16.4.9 Time of planting. Time of planting is very important, regardless of the propagule type used. For example, seeds planted before the last frost in the spring may suffer heavy damage, and planting in midsummer may result in heat and drought stress of the seedlings as they sprout. Vegetative propagules may be planted when the ground is not frozen, and when the day temperatures average less than 20° C (68° F). With provisions for local climatic extremes and periods of severe storm or tide activity, propagules are best planted in early spring to midspring. Along the Gulf of Mexico and southeastern U.S. Atlantic coasts, planting is recommended in all but the summer months. Fall planting, although a horticulturally acceptable practice, is not recommended for marshes because severe loss of propagules may result from erosion of sediments from the young root systems before regrowth begins the following spring. To lessen shock, propagules held in storage inside a nursery or greenhouse should not be planted until temperatures at the field site are at least as warm as the storage area. Propagules held in shady areas should be gradually acclimated to sunny conditions to prevent blistering and death of



leaves. Propagules should also be acclimated to the salinity at the site. For example, if saltmeadow cordgrass propagules are dug from a donor marsh of 5 ppt salinity to be planted in a marsh of higher salinity, they could be maintained at 5 ppt until about 4 weeks before planting when they should be moved to a solution of the same salinity as the accepting marsh. If there is a large difference of at least 10 ppt, gradual acclimation is necessary.

5.16.4.10 Dredged material (soil) bed preparation and treatment. Initial dredged material assessment should have revealed certain characteristics of the substrate: texture; salinity; nutrient level; potentially toxic levels of metals, pesticides, and petroleum products; and other site-specific characteristics. These characteristics were considerations—used to select species and propagules—must also be considered in the preparation of the soil bed and any treatments needed for planting, such as liming and fertilizing. Actual plot preparation should take place just prior to planting of the site. Sandy dredged material placement sites often can be graded to achieve desired slope and elevations; fine-textured material cannot be easily modified once placed. Dewatered and potentially acidic material may be encountered at higher elevations within the marsh development site. Modification of the pH of this dewatered material, using some form of lime, may be necessary if the pH is less than 5.5. Fine-textured dredged material seldom needs fertilizer as it tends to be rich in nutrients. A positive short-term plant response generally can be obtained by fertilizing sandy material, and it is usually recommended on highly erosive sites. However, long-term survival of the site may not be affected by fertilizer applications. In general, under marsh conditions of periodic inundation, fertilization is not recommended.

5.16.4.11 Plants for dikes and breakwaters. Temporary or permanent dikes or breakwaters must often be erected to contain fine-textured dredged material. It may be advantageous to stabilize these with plants to reduce erosion. Representative plants that may be used successfully on dikes in coastal areas are saltmeadow cordgrass, saltgrass, groundsel tree, marsh elder, common reed, seaside goldenrod, beach panic grass, and coastal Bermuda grass. These are established using agronomic upland practices discussed in Sections V (“Upland Habitats”) and XI (“Strip Mine Reclamation, Solid Waste Landfill, and Alternative Uses”) and in Hammer and Blackburn (1977); Hunt et al. (1978); Doerr and Landin (1983); and Environmental Laboratory (1985). Dikes in interior and freshwater areas may be planted with species such as tall fescue, reed canary grass, giant reed, common reed, common Bermuda grass, and switchgrass. In riverine freshwater areas, use of willow, alder, birch, and other woody species has been successful as well as the use of some tule, bulrushes, and cattails. All these species may be seeded, and most are commercially available.

#### 5.16.5 Potential problems.

5.16.5.1 Project timing. Dredging and biological calendars frequently do not match. There are two key items regarding biological scheduling: predictable lead time is necessary to prepare some propagule types, and planting is usually best in the spring. Transplants grown in a greenhouse cannot be held beyond a certain point without greatly increasing costs and weakening the propagules. Similarly, seeds must be collected when they mature in the field and often will not remain viable for extended periods of time. Dredging schedules are often variable, particularly so when new placement techniques are being employed. In almost all situations the

dredging schedule will predominate; therefore, it is best not to initiate all planting preparations until dredging times are assured. In most situations a delay of 4-6 months between completion of dredging and propagation will be acceptable. If this is not acceptable, the dredging schedule should be adjusted if possible. Late summer dredging usually results in a site being ready for propagation in the spring of the following year. It is often not possible to dredge and plant in the same calendar year as both procedures are subject to time constraints and delays.

5.16.5.2 Contaminant uptake by plants. Metals and chlorinated hydrocarbon compounds commonly associated with industrial, agricultural, and urban areas may be transferred to marsh plants from the air, water, or marsh substrate. When contaminated dredged material is used for marsh development, the potential for contaminant transfer should be considered. This potential problem is discussed in Chapter 4, "Confined (Diked) Placement."

5.16.5.3 Invasion of nonpreferred plant species. In brackish or freshwater marshes, invasion of unwanted plant species, such as purple loosestrife or common reed, can occur readily if propagules of those species are already present nearby. The most frequent invader in the Atlantic and Gulf coast areas, with the exception of south Florida and Texas, is common reed; in freshwater areas, broadleaf cattails may create dense stands. Although these two species have value for soil stabilization and wildlife use, they may grow in too dense a stand for maximum wildlife diversity and, therefore, require control. If the final elevation of a salt marsh substrate is higher than planned and relatively free of tidal inundation, common reed and more upland species may invade. In northern U.S. fresh marshes, purple loosestrife is developing into a major pest species. At higher elevations at which tidal inundation still occurs, a high marsh may result when a low marsh was planned. Once common reed forms dense stands and traps great quantities of sediment, one of its primary habits, it can be controlled only by three means: herbicides, introduction of sea-strength salinity, and raising or lowering the elevation beyond ranges in which it can survive. In California and the Pacific Northwest where smooth cordgrass, the best native species for saltmarsh propagation in the Atlantic and Gulf regions, is not a native and has never occurred, invasions are displacing native west coast marsh species and mud flats. Smooth cordgrass has found a niche on the Pacific, and can outcompete native species. The primary problem with this invasion is that the cordgrass has an unknown effect on west coast fisheries and sediment modifications. It can be controlled with difficulty by use of herbicides approved for intertidal zones, shading with dense black plastics, or excavation to a subtidal zone in which it cannot survive.

5.16.5.4 Pests and diseases. Wildlife and feral animals of domestic breeds can destroy newly planted vegetation or retard succession by grazing or trampling. Grazing pressure varies among regions and situations. Potential control methods include fencing the site to exclude pests, trapping and removing pests, locating the site at a sufficient distance from pest sources, and planning the project to avoid a known pest problem. Infestations of harmful pests, such as chewing insects and snails, can cause occasional problems and should be dealt with, if necessary, as they occur. Pest prevention techniques should be tailored to the site. While plant diseases do occur among marsh species, healthy stands will generally not become heavily infected. Only in cases of severe infections should control measures be undertaken, such as the Galveston Bay, TX, smooth cordgrass plantings, discussed in paragraph 5.16.4.



5.16.6 Postpropagation maintenance and monitoring. Monitoring of beneficial use sites is discussed in detail in Section XIV, "Baseline and Monitoring Studies." There are two major considerations in postpropagation phases of any marsh project: to maintain or not to maintain the site. Nonmaintenance has the advantage of allowing natural succession to take place once the initial establishment is ensured and involves no additional expenditures. Disadvantages that could result from the lack of maintenance include plant invasion by unwanted species, colonization by undesirable wildlife species, and major changes in site topography from climatic forces. Monitoring can determine the need for further soil treatment, control for pests, removal of debris accumulations smothering plants, additional plantings, and determination of site progress and success.

5.17 Engineering Aspects of Wetland Habitat Development. Field investigations and laboratory tests required for sediment characterization and substrate design in wetland habitat development, whether marsh or forested wetland, are similar to those required for design of conventional dredged material placement areas. The term substrate here refers to the dredged material upon which a marsh is developed. The elements of substrate design include configuration, elevation, protection, and retention. Required field investigations and laboratory tests, as they pertain to habitat development in saltwater or freshwater sites, include channel investigations, site investigations, bottom topography, evaluation of wave and water energy, and substrate foundation investigations, including consolidation and sedimentation. More detailed descriptions of certain procedures are contained in Palermo, Montgomery, and Poindexter (1978) and Hayes et al. (2000). Engineering design of substrate for marsh habitat development consists of defining elevation, slope, shape and orientation, and size (area and volume). The design must provide for placement of the dredged material within the desired limits and required elevations, allowing for settlement due to consolidation of dredged material and foundation soils. Adequate surface area or detention time must be provided for fine-grained sediments to allow settling of suspended solids in order to meet effluent criteria during construction. Various aspects of substrate design are discussed in Environmental Laboratory (1978), Palermo, Montgomery, and Poindexter (1978), and Hayes et al. (2000). Procedures are equally applicable to both saltwater and freshwater sites.

5.17.1 Elevation control requirements. The most critical aspect of a marsh development project is usually attainment of a precisely defined, stable elevation. Unconfined substrates normally developed with coarse-grained dredged material do not undergo significant settlement due to self-weight consolidation. They may, however, require considerable shaping and shaving down to reach an intertidal level (Figure 5-21) although settlements due to consolidation of compressible foundation soils do occur. Confined substrates are normally developed with fine-grained dredged material, and significant settlements of confined substrates may occur due to self-weight consolidation. One-time construction of confined substrates presents the most critical requirement of prediction of settlements since the initial placement of dredged material must be such that a final elevation within acceptable limits is achieved (Figure 5-22). Since the substrate surface cannot be raised by later placement of additional material, the design must include predictions of settlement to be expected. A computer program within ADDAMS (paragraph 2.6.4) has been designed to aid with these predictions and calculations. In incremental construction, the substrate surface elevation is raised by supplemental placement of dredged material, and an exact prediction of settlement for initial layers is not required. Field experience gained by observation

31 Jul 15

of settlement behavior of the initial dredged material layer may be used to aid in prediction of settlement of subsequent layers.



Figure 5-21. Heavy Equipment was Required to Shave Down Sandy Dredged Material Deposits to Intertidal Levels at Bolivar Peninsula, TX, and at Other Man-Made Wetland Sites

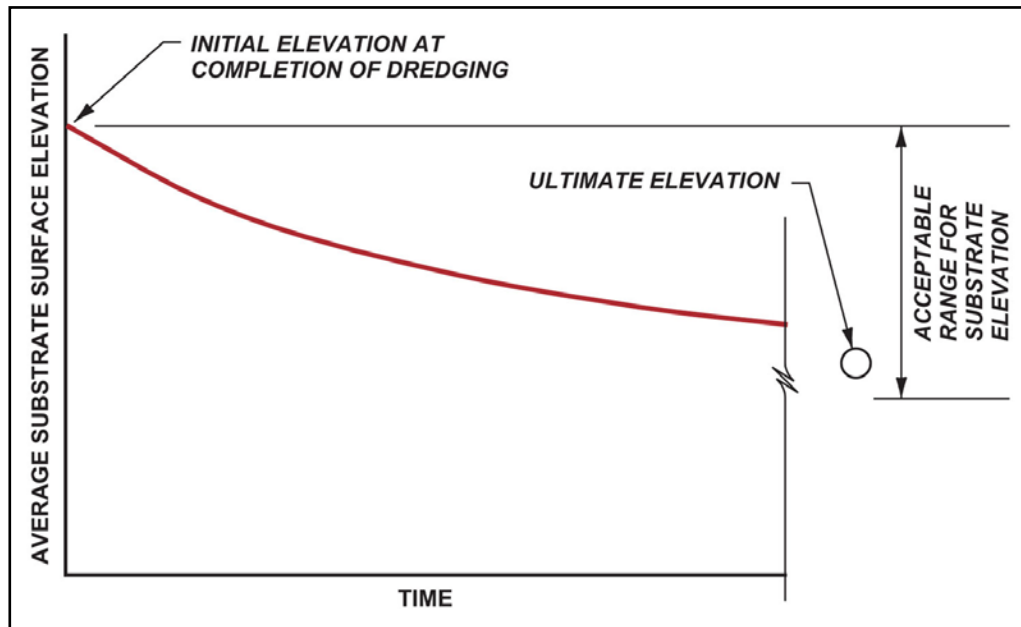

Figure 5-22. Dredged Material Substrate Surface Elevations Versus Time

5.17.2 Design for sedimentation. Confined substrates composed of fine-grained dredged material must be designed for retention of the solids by gravity sedimentation during the dredging operation. Design for sedimentation is directly affected by the size of the containment (area

and volume), inflow rate (a function of the dredge size), operational conditions, physical properties of the sediment, and salinity of the dredging environment. Design procedures are available that provide for determination of the surface area or detention time required to accommodate continuous dredged material placement. Factors influencing hydraulic efficiency of the substrate containment must also be evaluated, including effects of short-circuiting, ponding depth, weir placement, and shape of the containment. If the substrate containment does not provide for adequate sedimentation within the project constraints, it may be possible to increase the substrate containment size, decrease the placement rate by using a smaller dredge, or increase settling time by using intermittent operations.

5.17.3 Weir design. Retention structures used for confined substrates must provide a means to release carrier water from the placement site. This is best accomplished by placing a weir structure within the substrate containment. The weir structure must be designed to provide the capability of selective withdrawal of the clarified upper layer of ponded water within the containment without excessive resuspension and withdrawal of the settled solids. Weir design is based on the assumption that sufficient surface area or detention time has been provided for sedimentation and that short-circuiting is not excessive. Weir design procedures are described in Walski and Schroeder (1978) and Hayes et al. (2000).

5.17.4 Requirements for retention and protection. Site hydraulics and sediment properties determine the need for retention and protective structures at marsh development sites. These sites may require structural protection from erosion caused by currents, waves, or tidal action. A retaining structure may also be required to retain the dredged material until it consolidates and to control the migration of suspended fines. The first step in the selection of a retention or protective structure is to validate the requirement for such a structure (Landin, Fowler, and Allen 1994). Particular concern should be given to the effects of any proposed structure on current or wave patterns. Structures that may constrict water flow and increase local current velocities or reflect wave energy may increase erosion. Much of the engineering discussion in this part is detailed in Eckert, Giles, and Smith (1978). The relationships between erosion, transportation, and deposition velocities and the sediment grain size are summarized in Figure 5-23. Values are based on velocities measured 15 cm (6 in.) above the bottom of a sediment.

5.17.5 Structure selection considerations. Considerations in containment structure selection include the dredged material to be retained or protected, maximum height of dredged material above firm bottom, required degree of protection from waves and currents, permanence of the structure, foundation conditions at the site, and availability of structure material (Chasten et al. 1993). These considerations determine feasibility of a structure in relation to the project goal, the likelihood that the structure can be maintained over its useful life, and the total cost of the structure. These factors are site-critical and require engineering site data. Several retention and protective structure types are considered technically feasible for use in marsh habitat development and are illustrated in Figure 5-24. On the Gaillard Island CDF, the Mobile District has used a technique where geotextile fabric was laid from land seaward, overlain with riprap, then the seaward fabric end was overlapped back toward the land, and subsequently covered with riprap. This method allowed wave action to undermine the fabric-wrapped riprap and cause it to drop down and create a vertical wall of fabric-enclosed riprap that had been successfully

31 Jul 15

demonstrated to provide toe protection for the riprap dikes. Two types of structures are likely to be used in habitat development projects: sand dikes and fabric bags and tubes (Landin, Fowler, and Allen 1994; Davis and Landin 1997).

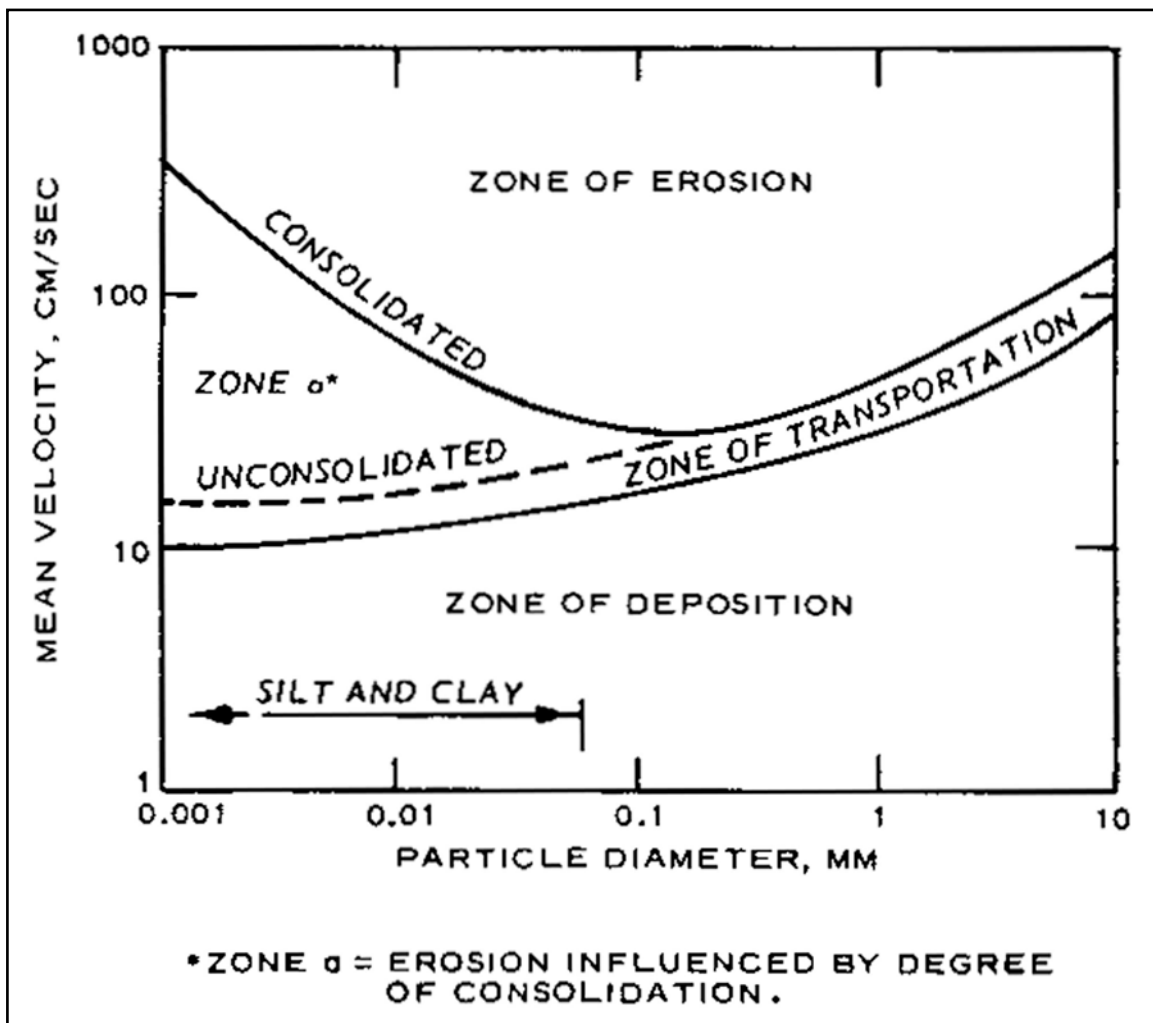

Figure 5-23. Erosion-Deposition Criteria for Different Grain Sizes

#### 5.17.6 Design considerations.

5.17.6.1 Final elevation of the substrate must be considered in the site design. The first step is to establish the desired elevation of the proposed marsh. Anticipated foundation and fill consolidation to obtain maximum fill level, maximum ponding level, and theoretical maximum dike height of structure include any additional freeboard that may be necessary to prevent overtopping. Allowances for retention structure settlement must also be considered. In the design of containment structures, all the water and earth pressure forces acting on the structure must be considered as well as any surcharge that is anticipated during construction or in later use. New substrate that requires a retaining structure is generally composed of soft clays and silts, which remain in a slurry state for a significant period after placement. A fluid pressure loading may be

exerted on the retaining structure until the substrate begins to consolidate and develop shear strength.

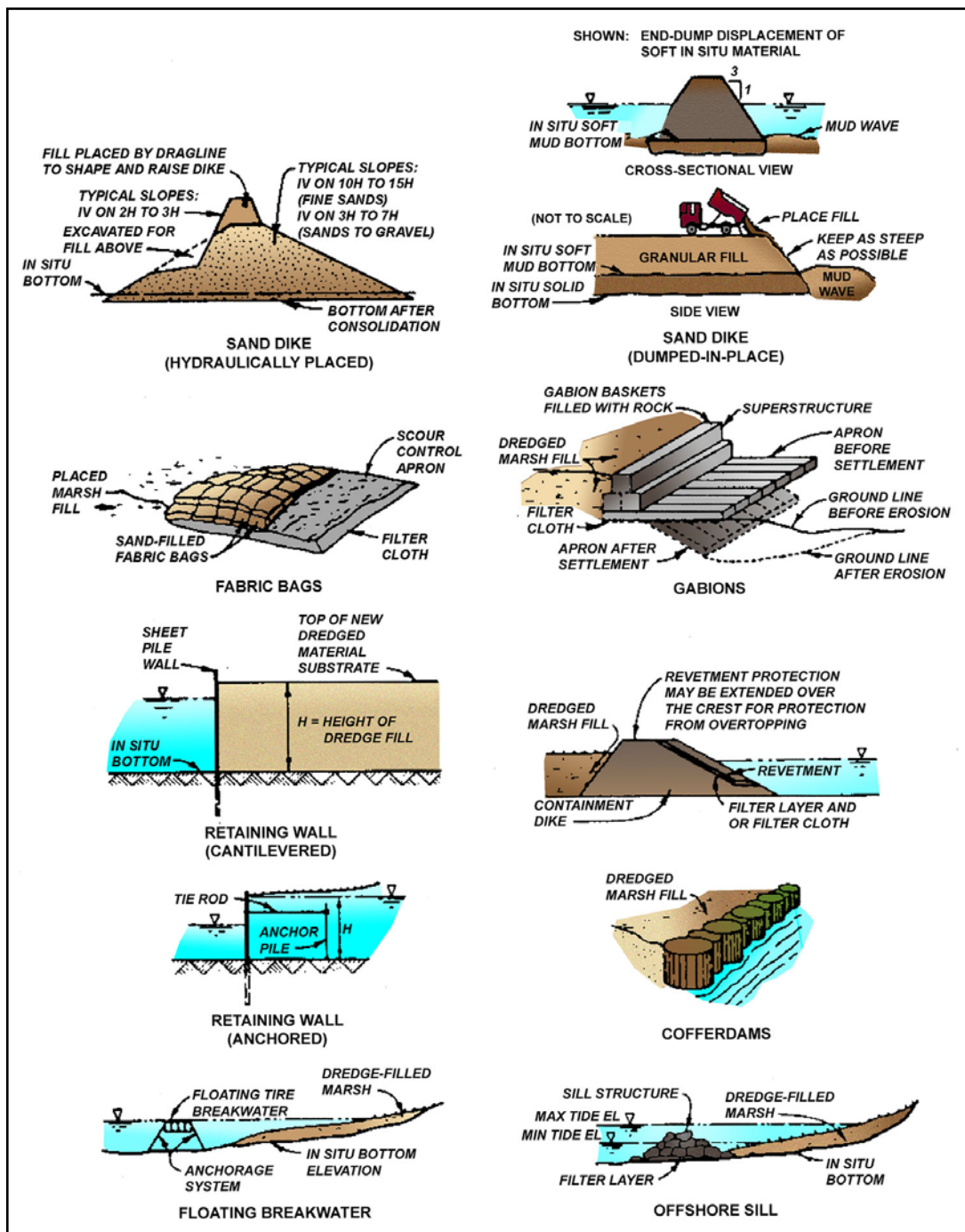

Figure 5-24. Retention and Protective Structures (from Eckert, Giles, and Smith 1978)

5.17.6.2 Wind wave characteristics—such as height, period, direction, and the probability of occurrence—can be found using locally collected data and hindcasting methods. Subsurface runoff can have a very detrimental effect on frontal edges of marshes and wetlands (Davis and

Landin 1997). At sites where wind waves appear to be a major consideration, early recognition of that fact may permit relocation or shifting of the site to reduce the open-water fetch in the predominant wind direction, thus limiting the maximum wind-generated wave. In shallow back bays and estuaries, water depth frequently limits the growth of wind waves (Eckert, Giles, and Smith 1978).

5.17.6.3 Ship-generated waves may also be a major cause of erosion along the edges of marshes. Wave measurements properly timed to ship traffic at the dike site allow establishment of a design value. Erosion and scour cause the removal of soil particles by water action above and below normal water surfaces; they can cause structural failure and must be guarded against by properly designed protective structures. The erosive ability of water waves and currents at a potential placement site must be considered in the selection and design of a retaining structure and its foundation. Erosion can be minimized by proper location and orientation of the retention/protective structure. Locating the site in a low-energy environment is the ideal solution and a must in many areas. Flattening the outer slopes of the fill or dike reduces turbulence and scour. Streamlining the upstream face of the fill also lessens erosion. Vegetation may be used to stabilize the dike and reduce erosion. Protection of inner and outer surfaces by the use of geotextiles, filter cloth, revetment, or antiscour blankets of rubble may be required in higher energy situations. Protection created by geotextile or rubble breakwaters or floating wave attenuating devices is also possible, but it may not be as enduring nor as economically feasible (Eckert, Giles, and Smith 1978; Hayes et al. 2000; Davis and Landin 1997).

5.17.6.4 In riverine environments, an important consideration in determining water velocity must be the effect the fill placement will have on altering the flow conditions. When the fill decreases the cross-sectional area of a channel, there are resulting increases in flow velocities and/or water surface elevations. These should be estimated and used to evaluate the erosion and scour potential. Foundation stability, stress, settlement, and seepage forces and piping are also important considerations in site design (Eckert, Giles, and Smith 1978; Palermo, Montgomery, and Poindexter 1978) (Figure 5-25) as well as wave and current conditions, tidal range, water depth, bottom conditions, and distance from the dredging site (Eckert, Giles, and Smith 1978). Construction techniques and control of these structures are discussed at length in Eckert, Giles, and Smith (1978) and Palermo, Montgomery, and Poindexter (1978).

5.17.7 Weir structures. Weir structures are required for release of water during and after the filling operations and should be considered an integral part of the retention/protective structure. Weirs should be well- anchored and collared. Two basic types of weirs are the drop inlet and the box. The drop inlet weir is most commonly used in USACE confined placement operations. The structure consists of a half-cylinder corrugated metal pipe riser equipped with a gate of several stop logs or flashboards that serve as a variable height weir. They can be added or removed as necessary to control flow into and out of the containment area. A discharge pipe leads from the base of the riser through the dike to the exterior. The box weir consists of an open cut through the entire dike section. The cut is usually lined with timber but could be lined with concrete or steel. Box sluices also use stop logs for controlling drainage. While box sluices are not often employed, they are capable of rapidly discharging large volumes of water. This feature could prove advantageous in marsh establishment since natural water level fluctuations throughout the

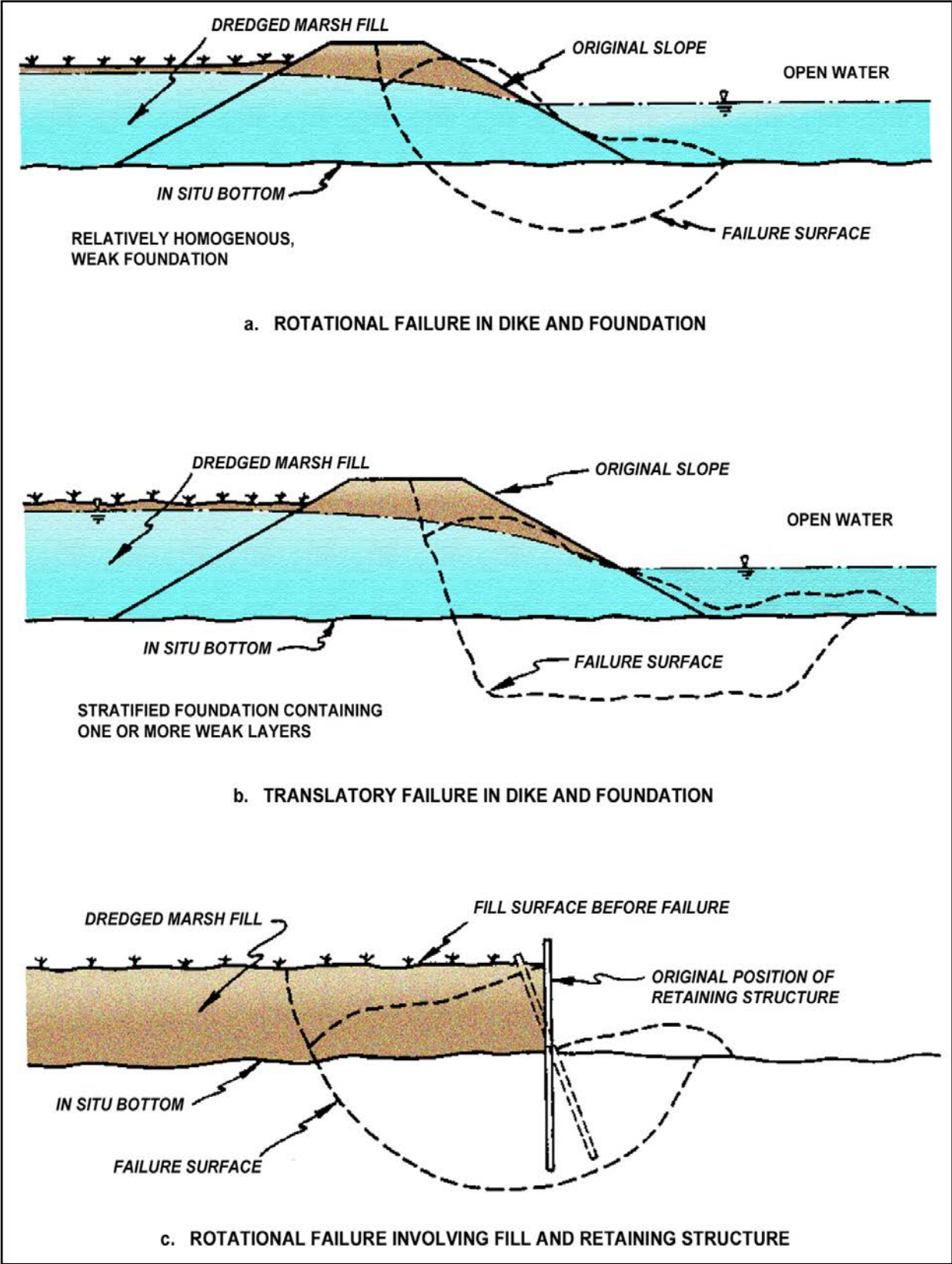

Figure 5-25. Examples of Typical Slope Failures (from Eckert, Giles, and Smith 1978)



containment area may be necessary during construction and are essential to the natural operation of the new marsh. Additional information regarding weir design, construction, and operation can be found in Hammer and Blackburn (1977); Palermo, Montgomery, and Poindexter (1978); Walski and Schroeder (1978), and Hayes et al. (2000).

5.17.8 Dredged material placement operations. Material may be placed within the placement site using either hydraulic or mechanical methods. The hydraulic pipeline dredge is by far the most commonly used method and provides the major source of material to be used for marsh establishment. Pipeline length can be extended to several miles with the addition of intermediate booster pumps, but at a substantial additional cost (Environmental Laboratory 1978). Bucket-loaded scows can be unloaded by direct pumpout with hydraulic unloaders (Figure 2-34). The pipeline dredge can place material in shallow-water areas through the use of shore lines or shallow-draft floating pipelines. Detailed information on obtaining selected dredged material for dike construction, operations for placement of the material, movement of pipelines in shallow-water areas and on the shoreline, energy dissipaters, operational guidelines, and the influence of dredged material placement on structures is presented in Environmental Laboratory (1978).

5.17.9 Management activities for confined substrate placement. Placement of dredged material within a confined area is identical to placement in any other containment area. Certain management activities are, therefore, necessary to ensure that suspended solids are retained within the area and that effluent quality is maintained (Bartos 1977b; Palermo, Montgomery, and Poindexter 1978). Surface water can be managed by controlling the elevation of the outlet weir(s) throughout the operation to regulate the depth of water ponded within the containment area. Proper management of surface water is required to ensure containment area efficiency and can provide a means for access by boat or barge to the containment area interior. At the beginning of the placement operation, the outlet weir is set at a predetermined elevation to ensure that the ponded water will be deep enough for settling as the containment area is being filled. As the operation begins, slurry is pumped into the area; no effluent is released until the water level reaches the weir crest elevation. Effluent is then released from the area at about the same rate as slurry is pumped into it. Thereafter, the ponding depth decreases as the thickness of the dredged material deposit increases. After completion of the placement operation and of the activities requiring ponded water, the water is allowed to fluctuate with the tides through the existing weir structure. Use of the ponded water for floating the pipeline within the containment area can be of benefit to general containment area management by greatly facilitating the movement of the inlet point without disruption of the dredging operation. The floating inlet allows selective placement of coarse-grained material behind the retention structure or at desired mounding locations within the substrate. Once the substrate has achieved the desired degree of stability and after careful consideration of the erosion potential of such an action, the weirs or retention structure may be breached to allow natural water circulation throughout the substrate area.

5.18 Wooded Wetland Habitats. In contrast to the numerous marsh development examples, case studies, and research projects, far fewer examples and studies of development of wet woodlands on dredged material have been researched or field implemented. Landin (1982) developed guidelines and drew restoration plans for bottomland hardwood sites and floodplain islands, and Hayes et al. (2000) discuss such projects and designs at great lengths. Guidelines are not available for



bald cypress/tupelo gum swamps nor for northern woody bogs, types of wooded wetlands commonly encountered by the USACE. In general, dredging operations and placement sites are carefully steered away from wooded wetlands, and wooded wetland habitat development has been infrequent. Many of the factors discussed in detail for using dredged material to construct and maintain marsh development apply to wooded wetlands and, therefore, are not repeated here.

5.18.1 Considerations. There are several considerations to development of wooded wetlands on a placement site. First and foremost is the fact that the site will be lost for all future placement operations as a forested site requires more than 100 years, in many cases, to mature and provide optimum habitat. However, for one-time placement operations in areas where forest and natural spaces are desired, wooded wetlands may be the solution for beneficial uses. Other considerations include costs and the habitat needs within a region. For example, a moderately contaminated placement site \unsuitable for herbaceous species that may be eaten by geese or other waterfowl can be planted in trees, which take decades to grow to maturity. This passage of time helps deflect any problems of uptake and consumption, and provides a safer habitat solution to the need for wetlands in a region.

5.18.2 Advantages. Wooded wetland development as a placement alternative has several distinct advantages:

- a. Improved public acceptance.
- b. Restoration/creation of biologically desirable habitats.
- c. Long-term improvements to marginal soil/sediment sites.
- d. Elimination of problem areas.
- e. Extensive root systems hold soil.

5.18.3 Disadvantages. There are also a number of disadvantages to wooded wetland development as a placement alternative:

- a. Incompatibility with subsequent placement.
- b. Loss of placement site for future use.
- c. Planting costs.
- d. Root penetration.

5.18.4 Maintenance. Once a placement site has been planted in woody species seeds or seedlings (transplants), survival in a wet environment may be difficult. Many species of trees and shrubs evolved with fluctuating water levels and, therefore, must have these conditions for long-term survival. No tree or shrub species germinates naturally in standing water; there must be a mud flat on which seeds can germinate. For example, one of the reasons that natural even-age stands of bald cypress and black willows can be seen on sites is because they all germinated in

the same very dry year when water levels were low. However, extended flooding on small seedlings may drown most or all of them, and a site may require replanting. Certain woody species—such as willows, Nuttall oaks, bald cypress, and tupelo gums—can tolerate several months of inundation by turbid water and recover in riverine conditions. Once seedlings reach a height that extends above most floods and have a root system capable of storing enough oxygen to withstand long inundation, maintenance is minimal. An estimated 5-10 years is needed to observe and essentially manage the site as a young tree nursery to ensure its long-term survival and to guide its ultimate forest community.

#### 5.19 Guidelines for Wooded Wetland Development.

5.19.1 Selection of wooded wetland type. Most trees and shrubs grow in communities that include numerous invader species, secondary species, climax species, understory shrubs and small trees, vines, and forest floor species. It is impossible to replicate all of these in a man-made situation, including on a dredged material placement site.

5.19.1.1 Natural colonization. Almost all of the forest wetland dredged material examples in the United States are from natural colonization, where the dredged material was placed and then left to develop on its own. Under such conditions, the elevation at which the dredged material was left as well as the quality, quantities, and fluctuations of the water are absolutely critical in determining what plant community will ultimately grow on the site. For example, sand and gravel dredged material deposits in the lower west Pearl River, on the northern Gulf coast between Mississippi and Louisiana, colonized with typical, healthy bottomland hardwood forests after material was placed there in 1955 (Landin 1993). Elevations of mounds of material were moderated by seasonal flooding, and the flooding influenced which hardwood species and understory colonized and ultimately survived on the numerous sites along the riverbanks. In contrast, at Pointe Mouillee in Lake Erie, cells within the confined island constructed in 1980 colonized densely with black willows and shrubby species and still remained at that stage in the late 1990s (Landin 1993). Young trees were then approximately 15-20 years of age, but they already supported colonies of nesting wading birds. Still more distinct and different, at Kenilworth Marsh in Washington, DC (Landin 1993), a wooded wetland community once existed, and dredged material was used to bring the degraded subtidal site back to a planted emergent marsh in 1993. The forest community has started to reclaim the site naturally since the optimum elevation has been provided for woody seeds to germinate and survive. Attempts to plant such woody communities would not be nearly as successful as the natural colonization process.

5.19.1.2 Types of wooded wetlands. Throughout the United States, wooded wetlands on dredged material deposits occur under numerous conditions. In the Columbia River system, low islands are colonized with alders, birches, willows, and other shrubs, and such conditions, if planting is desired on a site, should be replicated as much as possible. In the southern United States, along the Atlantic and Gulf Coasts, wooded wetlands on dredged material generally are either intertidal forests and swamps, well protected with very low daily freshwater tidal fluctuations, or shrub communities fringing or interspersed with emergent marshes. Of these two distinct types, the fringing shrub communities can more easily be propagated successfully

through the introduction of seeds or seedlings of selected species, with the emergent marsh serving as a nurse crop for the young woody plants. There are very limited or no examples of northern U.S. coastal or New England woody communities on dredged material, but many of the large confined placement facilities in the Great Lakes are colonizing with typical hydrophytic and moist forest tree and shrub species over time.

5.19.2 Design of wooded wetland type. For an engineer, the design of a placement site that will be planted or allowed to colonize as a shrub and tree community is essentially the same as for a marsh community. Once the material has been placed and dewatered, however, it is essential that either the containment dikes be modified or the weir be actively maintained long after the placement operation is completed to provide the proper hydrology for the site. In this case, the dike and/or weir serves as a long-term water controlling structure; and if the plant community that is desired is one that survives and grows under fluctuating water levels, it may be necessary to maintain a weir system that can be actively managed over the course of time to allow these fluctuations to occur. Since a placement site will be taken out of active use when planted or allowed to colonize in shrubs and trees, active management of the site is harder to justify under USACE mandates from a cost or navigation standpoint. Therefore, seeking natural resource partners who will assume responsibility and management of forested wetlands on dredged material sites is encouraged.

5.19.2.1 Location. A forested wetland on dredged material can be located anywhere in U.S. waterways where forested wetlands occur (essentially anywhere, including Alaska). That said, such sites should be protected from wind and wave energies, at least initially, but not from seasonal flooding. Certain types—such as bottomland hardwoods, riverine swamps, and button-bush flats—should not be exposed to long wind fetches. However, stream and lake/reservoir bank species—such as willows, alders, and birches—can grow very well under exposure conditions once established and can be used to hold dredged material deposits in fresh water along reservoir and river banks. Forested sites generally thrive best in at least semiprotected conditions.

5.19.2.2 Elevation and soil. Elevation determines what the plant community will be, initially with invader and secondary species and ultimately with climax forest species. The type of dredged material (sand, silt, clays and mixtures of these) also plays an important but subtle role in determining the final plant community and should be considered. For example, a heavy clay dredged material will colonize with or grow such species as buttonbush and spicebush, and a sandy dredged material site will grow almost any woody species adapted to the elevation and the geographical region once it begins to trap fines overlying the sand, but sandy deposits that function like natural sandbars and do not trap fines will grow distinct communities of such species as hackberry, sugarberry, and American elm.

5.19.2.3 Orientation, size, and shape. Forested dredged material sites can be of any orientation and shape as long as elevation and hydrology are correct, and some protection is provided from wind and wave energies. Examples of successful woody dredged material sites range from less than 0.1 ha to more than 10 ha in size, and from in-stream dredged material wetland islands to fully protected back channel intertidal swamps.

5.19.2.4 Multiple communities. Often, dredged material sites that either colonize with or are planted in woody species are not just wetlands but contain significant portions of the site as upland and transition zone areas. A highly successful example of these multiple-habitat dredged material sites is in the intertidal freshwater zone of the Hudson River between Troy and West Point, NY, where decades of dredged material deposits were sidecast onto river islands. These deposits are now growing, depending on elevation and hydrology, in wet shrub communities interspersed with emergent marsh, transition zone forest where species tolerate “wet feet” or upland forest with trees of as much as 50-90 cm (20-35 in.) diameter breast height (dbh).

5.19.3 Reevaluation and construction. These procedures are very similar in protocol, process, and planning steps to those for marsh development.

5.19.4 Vegetation establishment.

5.19.4.1 Woody plant communities on dredged material can occur through natural colonization or by initial planting of selected species. This can include introduction via seeds or seedlings of climax species early in the successional process to hasten maturity of the forest. For example, acorns and nuts of hardwood mast species should be planted on a site as soon as possible if that is the desired climax forest. These young seeds and seedlings can be planted within a nurse crop of herbaceous forbs and grasses for protection. The reason for early introduction of climax species to the dredged material site is that studies have found that once a disturbed site is left alone, the successional process of colonization by initial invaders to initial colonization of climax forest species may be 30-50 years. Even with careful planting, it is often very difficult to get climax species to survive under initial conditions due to many factors. Some of these include lack of soil mycorrhizae to assist root growth and nutrient uptake, heat buildup in soil unprotected by shade, long spring flooding periods that drown young seedlings, summer and fall droughty conditions that stress young plants, lack of adequate nutrients, and a number of other factors unique to new wet forest sites.

5.19.4.2 In addition, a number of exotic forest species—such as Australian pine, Chinese tallow tree, Brazilian pepper, and malaleuca—have been introduced into the United States. These species, which are problems in the southern United States, colonize dredged material readily and may require control to allow room for and encourage growth of native species. In coastal Louisiana Chinese tallow tree is displacing black willows in some wetland areas, and they can survive as far north as Tennessee. The other three species are more typical of Florida and south Texas, but they can be extremely troublesome in natural and man-made wetlands. Malaleuca, especially, has invaded the Florida Everglades National Park and surrounding areas, and it is displacing native trees and shrubs. All of these species can and will grow by colonization on dredged material islands and fringes. Control is drastic and not very successful. Chemical herbicide injection has limited success, and controlled burns have no real long-term success. Changes in elevation and hydrology also have little effect because all four species also grow in uplands as well as wetlands. Although none can tolerate sea-strength salinity, neither can any native U.S. forest species.

5.19.4.3 The advantages of natural colonization are the low costs and the provision of a diverse plant community. The disadvantages include invasion by exotics, as noted in the previous paragraph, and slow growth and maturity measured in decades.

a. Factors influencing design. The same four critical factors for emergent marshes apply to forested wetlands on dredged material: hydrology, geomorphology, hydrophytic vegetation, and protection from wind and wave energy. Site-specific factors to consider include salinity and tides, flood seasonality and endurance, soil texture and depth, contaminant tolerance, outside influences on the site, surrounding land uses, and costs.

b. Protection. The newly planted or colonizing forested site may require a nurse crop to provide protection from browsers and grazers, and from wind; it may also require some shade to tender stems, lower ground temperatures on root systems, and green manure for the growing trees and shrubs. Fencing off dredged material sites growing in woody species may also be required to keep out the deer, rabbits, beavers, muskrats, and other animals that eat young, tender tree bark, leaves, and shoots. Keeping such pest species out of sites is a perennial forestry problem, and ongoing battles of wits between managers and animals occur throughout the United States. Solutions range from scarecrows, propane-powered cannons, netting, and electric fences to live-trapping programs. Fortunately, all of these are short-term because once the young trees are big enough to survive on their own (3-10 years), vigilance and protective measures can be lessened.

c. Diversity. A more diverse site is definitely preferable as habitats for woody sites over monostands of trees, such as those found in softwood plantations. Wetland softwoods, such as sweet gum and American sycamore, can be and have been planted on dredged material deposits in monostands, and they have been harvested for pulpwood. However, it is important to identify, agree on, and follow through on the goals of a project. If a timber company buys or controls dredged material deposits in riverine or lake areas, it is their prerogative to plant and manage these sites in softwood plantations. However, in situations such as the Tennessee-Tombigbee Waterway, where close to 65,000 ha are being managed for wildlife habitat, many of these forested wetland acres, planting and colonization of the 5,600 ha of dredged material sites there are for diversity and optimum wildlife habitat.

d. Plant species selection and spacing. As with marshes, wooded wetland species selection depends on a number of factors: soil texture, elevation, hydrology, goals of the project, costs, and availability of species and propagules. In general, if habitat is the primary project goal, the more diverse the plantings are, the better. Likewise, soil stabilization goals need trees and shrubs capable of holding soil under wet conditions. Pulpwood plantations plant monostands of wetland trees (sweetgums, eastern cottonwoods, American sycamores, green ash) as their goal because the managers are trying to maximize production and economics of the dredged material site. Shrub species should be planted on 3 m (10 ft) spacings. Secondary and small tree species should be planted on 5 m (16 ft) spacings, and climax forest trees (large trees that will reach 15-40 m [50-130 ft] in height) should be spaced on 10 m (33 ft) centers. Some will die as they crowd and compete in the new forest, but that does not matter. In planting a typical bottomland hardwood restoration project, 400 tree seedlings of oaks and hickories per acre (close to 1,000 per hectare) is recommended with the full acknowledgment that as they grow and time passes, a number of these may not survive.

e. Propagule selection and handling plant material. Seeds and seedlings are the only two available and effective propagules for woody species. Seeds can be harvested in autumn, stored

31 Jul 15

through winter months, and planted on sites in early spring. Tree and shrub seedlings require either purchase from a commercial or government tree nursery or collection of seeds in the fall, growing plants in a nursery setting, then transplanting them onto the dredged material sites. All of these methods have been field tested, and all work. Often, state forestry workers check on the same large healthy trees in state forests for years to see if they are producing a good crop of seeds, then go back and harvest them using shakers and dropcloths spread under the trees in the autumn. These acorns, hickory nuts, pecans, walnuts, and other seeds are then turned over to state tree nurseries for planting.

f. Planting the site. As noted in preceding paragraphs, spacings are important with woody species. Dredged material sites can be planted using either commercial tree planters or by hand with dibbles and mallets. If a site is very wet or the soil is soft (fine-grained), planting by hand is more efficient. This is a fast operation; a 10-member commercial tree planting team, such as those employed by timber companies and tree farmers, can transplant as many as 50,000 seedlings by hand per day. Machinery can work faster, but the terrain must be suitable.

g. Pilot study. A pilot study for forested wetlands on dredged material is not recommended, not because there may not be a need or a reason but because of the time involved with planting woody species and their slower growth rates. However, should a pilot study be desired, it is possible to plant one or more species of trees or shrubs in test plots on a site and to allow time for results. There is a need for more research in this area because in planting bottomland hardwood forests for mitigation on reclaimed marginal agricultural fields, it has been found that larger transplants with root balls survive much better than do bare root seedlings and that many seeds can be planted more cheaply than a few transplants, with an assumption that only about one half (or even less) will germinate and survive. On dredged material sites, especially sandy sites, it has also been found that bare root woody species do not survive well unless their root systems are inoculated with mycorrhizae due to the sterility and heat of the sand deposits. Mulches are also often needed on sandy soils, even in wetland conditions, to provide organic matter and shade to root systems.

h. Time of planting. Trees and shrubs can be planted any time of year that the ground is not frozen. However, the best times are in autumn (October-November) or early spring (January-March in the southern United States, March-May in the northern United States). This is especially critical if bare root seedlings are being used because they stress and die readily in heat and drought. Seeds can be sown any time of year, but best results occur if they are planted in winter and early spring in the southern United States by pushing them into the soil about 2-5 cm (0.8-2.0 in.) deep, and in the northern United States using the same technique but planted later in the spring months.

i. Bed preparation and treatment. It is not necessary to make a thoroughly prepared bed for transplants if they are being done by hand. In fact, debris and drift on a site help provide wind buffers and shade, and they distract herbivores from the seedlings. If a mechanical planter is used, however, the site must be smooth enough for it to transverse the site. Seeds can be planted by hand or by machine, and the same rules apply. If a site is planted by hand, there is no need to smooth it. If it is planted by machine, it must be smooth enough for transverse of the equipment.

j. Woody plants for dikes, berms, and levees. Although the USACE discourages planting of woody species on dikes, berms, and levees used for public safety and flood-control purposes, woody species are very well suited to such perimeters of dredged material sites when there is no danger to life. Shallow-rooted tree species with fibrous root mats, such as black willows, thrive on dikes and berms. So do sweet gums, American sycamore, and similar early colonizer species. There are several reasons for planting these perimeters with woody species:

(1) Attracting herbivores. Herbivores such as deer, rabbits, beavers, and muskrats find the planted trees on dikes and berms when they first approach the dredged material site, and their attention to these buffer/perimeter species may buy valuable time for wooded wetland species inside the dredged material site.

(2) Holding sediment and preventing dike breaching. Woody species do a much more efficient job of holding sediment and preventing erosion than do herbaceous species. If a dredged material dike is providing protection for the habitat being developed within, planting woody species on that dike will help maintain integrity and protection.

(3) Providing aesthetics and diversity. Forested dikes and berms are much more attractive from an aesthetic point of view to humans and provide more diversity for wildlife. Often, woody species will so completely cover a protective dike that viewers are unaware of its presence except in winter when leaves are shed.

5.19.5 Potential problems. The primary problems with wooded wetlands are not those of marshes, where dredging and biological windows are critical.

5.19.5.1 Project timing. A dredged material site is not planted with trees and shrubs until it has dewatered well, and the dredge will have moved on to other projects years before that time. At that point, it can be treated very much like a typical reforestation project.

5.19.5.2 Contaminant uptake. This is also not a great problem with wooded wetlands and, in fact, it is encouraged on sites where there are known contaminants. The use of tree and shrub species that do not take up contaminants into their trunks and leaves makes an ideal cover for moderately contaminated soils. A danger may lie in planting species that attract wildlife to feed on plant parts that may take up substances such as heavy metals. However, there has never been any research or data to indicate that this is a problem.

5.19.5.3 Invasion of pest species. In the southern United States, where invading exotic trees and shrubs have colonized and proliferated, this is a real danger. In some locations, such as southern Florida, active and intensive management are required to ensure that only the native species desired for a dredged material site is what colonizes and survives.

5.19.5.4 Pests and diseases. All forest trees and shrubs have leaf-eating insects and other species that they have evolved to tolerate. Forest diseases in healthy stands are also not often a problem, but it should be noted that Dutch elm disease is ravaging American elms, which grow in wetland soils in river systems and on dredged material in the United States. General

observations of planted and colonized stands on a regular basis should alert managers to any invasions, at which time standard forestry pest control practices should be applied.

5.19.5.5 Postpropagation maintenance and monitoring. Maintenance of woody sites growing on dredged material should not be an intensive requirement unless young seedlings drown or are eaten by herbivores, and require replanting again and again (precedents are noted for this). Monitoring should be planned and scheduled to carry through at least 10 years after planting, so that survival of the young trees and shrubs can be ensured for at least that long. A wooded wetland growing on dredged material does not mature for decades, but few monitoring programs can or will be in place for the length of time it takes for species to reach maturity. One of the rare exceptions to this is a site that was planted by the Tennessee Valley Authority (TVA) on its disturbed land around reservoirs at Land Between The Lakes, KY. This was not on dredged material, per se, but conditions were similar in many ways because the wet construction-disturbed sites were planting in wetland tree seedlings. Files were kept in TVA archives and rediscovered more than 70 years later, at which time comparisons and survival rates were checked. This is the oldest known man-made bottomland hardwood site in the United States, and it is thriving, but it still has not reached forest maturity. This is one of the study sites of the WRP (1990-1997).

5.19.5.6 Loss of placement sites for future use. This is such a significant “problem” that it is separated for discussion. Where dredged material containment sites are scarce, wooded wetland habitat is not an option because the site can no longer be used for placement of material. Where dredged material containment sites are becoming full, but retain some wet characteristics or can be modified to provide wetland hydrology, planting such sites in woody species is an attractive alternative.

5.19.6 Engineering aspects for wooded wetlands. Initial engineering techniques for dredging, placement, shaping, dewatering, and other aspects discussed for marsh development are the same for wooded wetland sites. Differences come after dewatering and a site is either being prepared for planting or to allow natural colonization to occur. Engineering aspects here focus on the installation or active maintenance of the weir, low-head dam, or other structure that manages the hydrology of the site for optimum wetland tree and shrub growth. The Natural Resources Conservation Service (NRCS) EM (NRCS 1992) for wetland restoration, creation, and management is an excellent source of information regarding engineering and biology of dewatered dredged material sites; it was coauthored by USACE scientists and engineers. Likewise, the interagency EM, published by NRCS (NRCS 1998), on stream corridor restoration and management is an excellent guide for riverine dredged material placement site reforestation and stabilization; it was also coauthored by USACE scientists and engineers. Such cooperative ventures as multiagency restoration guidance documents has enabled much more restoration to occur on all types of sites, including dredged material deposits of all ages. Another such document is planned on herbaceous coastal restoration engineering and biology.



## Section V Upland Habitats

5.20 General. Upland habitats encompass a variety of terrestrial communities, ranging from bare soil to dense forest. In the broadest interpretation, upland habitat occurs on all but the most disturbed placement sites. For example, a gravelly and bare placement site may provide nest sites for killdeer or tern species; weedy growth may provide cover for raccoons or a food source for seed-eating birds; and water collected in desiccation cracks may provide breeding habitat for mosquitoes. The essential fact is that man-made habitats develop regardless of their management; however, the application of sound management techniques greatly improves the quality of those habitats (Smith 1978). A widely used and highly visible upland habitat forest on dredged material is that on the islands in the intertidal Hudson River north of West Point. Others include higher zone bottomland hardwoods in the Lower Mississippi Valley, seasonally flooded river islands in the James River, Mississippi River, and other rivers where a predominance of upland/moist forest species occur, and at sites such as Riverlands at the junctures of the Missouri, Upper Mississippi, and Illinois Rivers, where wet prairie, upland forest, and wetland forest are all part of a large management scheme that includes dredged material placement habitats and islands.

5.21 Upland Habitat Development Considerations. Upland habitat development has potential at hundreds of placement sites throughout the United States. Its implementation is largely a matter of the application of well-established agricultural and wildlife management techniques.

5.21.1 Advantages. Upland habitat development as a placement alternative has several distinct advantages:

- a. Adaptability.
- b. Improved public acceptance.
- c. Creation of biologically desirable habitats.
- d. Elimination of problem areas.
- e. Low-cost enhancement or mitigation.
- f. Compatibility with subsequent placement.

The principles and applications of this alternative are adaptable to virtually any upland placement situation. Regardless of the condition or location of a placement area, considerable potential exists to convert it into a more productive habitat. Small sites in densely populated areas may be keyed to small animals adapted to urban life, such as seed-eating birds and squirrels. Larger tracts may be managed for a variety of wildlife, including waterfowl, game mammals, and rare or endangered species. The knowledge that a site will ultimately be developed into a useful area, be it a residential area, a park, or wildlife habitat, improves public acceptance. Many idle and undeveloped placement areas that are now sources of local irritation or neglect would directly benefit from upland development, and such development may well result in more ready

acceptance of future dredging and placement projects. Upland habitat development usually adds little to the cost of placement procedures and may involve liming, fertilizing, seeding, and mowing after dewatering. This can be done between scheduled dredging operations if they are on a 3-year or longer rotation. A typical level of effort would be similar to that applied for erosion control at most construction sites and considerably less than that encountered in levee maintenance. Unless the target habitat is forest, this type of habitat is generally compatible with subsequent placement operations. In most situations, a desirable herbaceous cover can be produced in one growing season. Subsequent placement simply requires recovery of the lost habitat. Indeed, the maintenance of a particular vegetation stage may require periodic placement to retard or set back succession (Soots and Landin 1978; Landin 1992b, 1997c).

5.21.2 Disadvantages. The disadvantages of upland habitat development are potential public opposition to subsequent placement and possible necessity of long-term management. The development of a biologically productive area at a given site may discourage subsequent placement or modification of land use at that site. This problem could be avoided by the clear identification of future plans prior to habitat development or by the establishment and maintenance of biological communities recognized as being most productive in the earlier stages of succession. In the latter case, subsequent placement may be a necessary management tool. Some habitat types require management. For example, if annual plants such as corn or winter wheat are selected for establishment for wildlife foods, then yearly planting will be necessary. If the intent is to maintain a grassland or open-field habitat, it may be necessary to mow the area every 2 to 5 years to retard woody vegetation. In most cases, it is possible to establish very low maintenance habitats, but if the intent is to establish and perpetuate a given habitat type, long-term management is essential and may be expensive.

## 5.22 Guidelines for Upland Development.

5.22.1 Upland habitat needs and assessments. Those upland habitats in limited supply should be identified and the opportunity for additional habitat assessed. Public attitudes are of particular consequence in the implementation of this alternative, and public opinion should be actively sought. Site selection should be made with a particular target habitat in mind as the importance of other habitats is greatly influenced by the needs and attributes of the surrounding area. The chemical and physical properties and the relative quantities of different types of dredged material should be evaluated to determine the characteristics of the soil to be used in the habitat development. Several remedial treatments are possible. For example, it may be possible to improve the agricultural characteristics of the surface layer by topdressing the site with material selected for its agronomic characteristics. It may also be possible to bury a problem upland soil such as USEPA-recognized brownfields by capping it with a layer of clean material.

### 5.22.2 Planning and design.

5.22.2.1 Assuming that upland habitat development has been selected as a placement alternative or as an enhancement measure, habitat planning and design guidelines are indicated in Figure 5-26. The criteria listed under site considerations are applicable regardless of whether the site is a new or previously used placement area. Local needs, and thus target wildlife species, will be determined primarily by the desires of state wildlife agencies and those of the public. These

needs are likely to reflect local perception of the value of wildlife. If the area has a strong hunting tradition, the emphasis may be on game animals. An example is the state wildlife management areas developed by joint effort of the USACE and the States of Mississippi and Alabama on 5,600 ha of dredged material placement sites in the Tennessee-Tombigbee Waterway. These sites, both upland and wetland, are being managed almost exclusively for hunting and fishing although there is also considerable interest on nongame and passive recreational uses as well (Hartley 1988). If there is strong agency concern for an endangered species, that may be the emphasis. In many cases, a target species per se will not be identified. Rather, a grouping such as “songbirds” or “small game” will be designated. The list of target species must be evaluated in light of the available habitat surrounding the site and the size of the placement site. The size of a placement area is seldom large enough to exert a significant impact on regional animal populations if it only duplicates existing habitat types. Therefore, the success of the site is usually determined by its ability to enhance surrounding habitats or remedy limiting environmental factors.

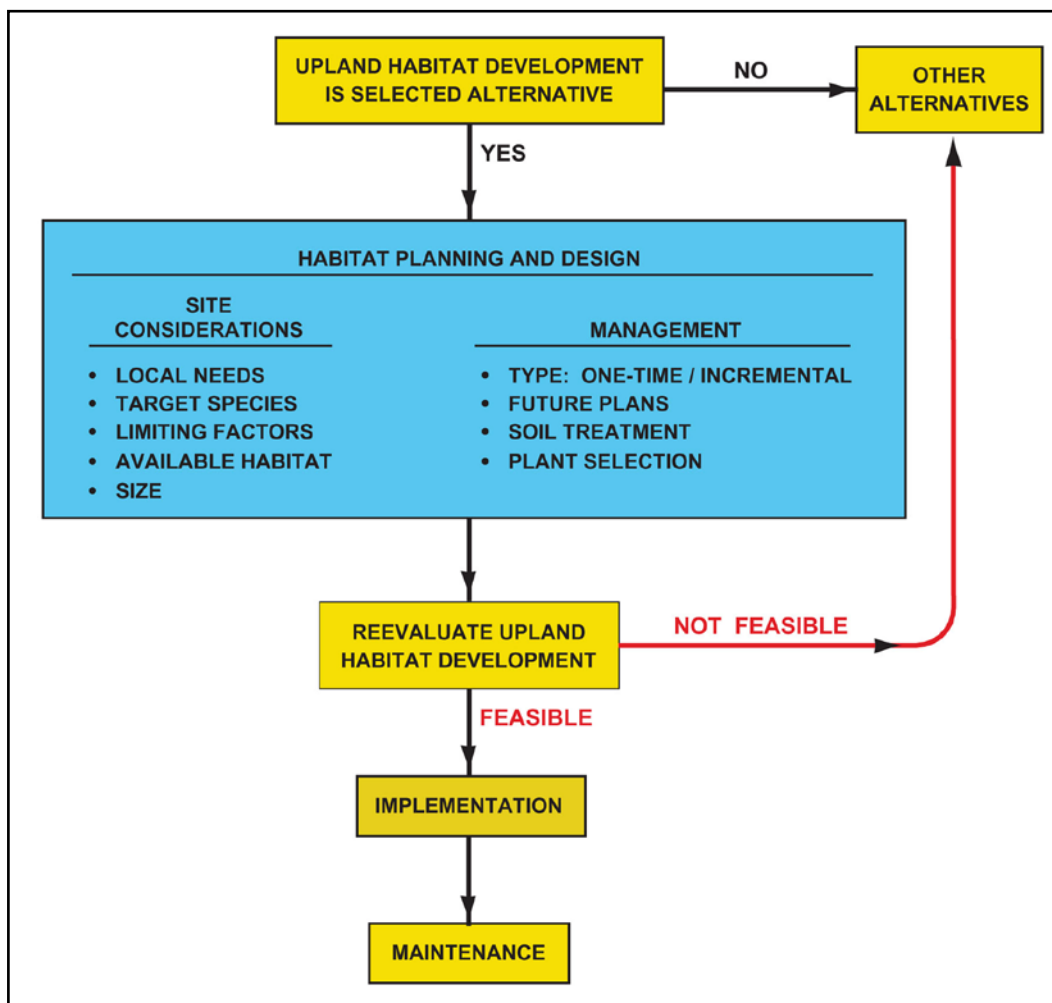

Figure 5-26. Guidelines for Selecting an Upland Habitat Development Alternative

31 Jul 15

5.22.2.2 Basic management decisions depend on the type of placement and future plans at the site. If one-time placement with periodic maintenance is planned, the management plan may be quite flexible. One-time placement without management indicates the need to establish a plant community that is relatively self-sustaining. If periodic placement is planned, plant communities that are rapidly functional are advised. Properly planned, periodic placement could be considered a wildlife management option used to control succession or diversify the habitat and avoid confrontation regarding subsequent activities. Future plans for any habitat development site should be well documented and understood by interested agencies and the public prior to implementation.

5.22.2.3 Soil treatment and plant selection are closely related and can proceed after determination of the type of placement, identification of the characteristics of the dredged material, and determination of target species have been completed. Soil treatment may include a variety of activities, such as burying problem materials, dewatering, mixing materials to obtain improved soil characteristics, leaching, fertilization, and liming (Figure 5-27). Plant selection is dictated by soil conditions and habitat preferences. In many situations it is possible to identify highly desirable natural plant communities near the placement area. Development of site conditions (soil, elevation, diversity) on dredged material that are similar to those of desirable plant communities encourages natural invasion and natural development of similar communities. When this is possible, a considerable savings in planting and maintenance costs may be realized.



Figure 5-27. Liming and Mixing Layers of Silty and Sandy Dredged Material at Nott Island Upland Site, Connecticut River, CT, in the 1970s; This Site has been a Nesting Meadow and Songbird Habitat for More than 25 Years

5.22.3 Reevaluation and implementation. If, upon reevaluation, the upland habitat development alternative remains feasible, the project may be implemented and subsequently maintained. Implementation is highly site specific but should present few difficulties beyond the problems typically encountered in contracting new or unusual work. Advice from local wildlife biologists, soil scientists, and experts experienced in working with such projects may prove invaluable in this stage.

### 5.23 Upland Site Development.

5.23.1 Site selection. Two types of upland habitat development sites have potential beneficial use: older, existing sites where habitat development and enhancement occurred and planned sites where upland habitat development is part of the project goal. In both cases, several factors determine selection of the best possible site: availability, placement need capacity, proximity to the dredging area, physical and engineering characteristics, environmental and social acceptability, tidal and current considerations, and habitat development feasibility.

5.23.2 Site characterization. After the upland placement site has been selected for development, field and laboratory investigations of the site and related areas should be initiated. If the site is an older placement area to be reclaimed, it and the surrounding area should be evaluated physically and biologically to assess its potential for habitat development and determine necessary action. If dredging and placement operations are involved, it is necessary to add information related to the capacity of the site, need for and design of a protective or retention structure, and construction details. This information should be collected in conjunction with characterization of the sediments to be dredged. Physical, biological, socioeconomic, and engineering tests should be made to determine site suitability (Hunt et al. 1978; Palermo, Montgomery, and Poindexter 1978; Landin 1997c) and acceptance. Target wildlife species should be identified, and other upland objectives, such as site stability and multiple habitat use, should be considered.

5.23.3 Vegetation establishment. Since upland habitat is developed primarily for wildlife and less often for erosion control, it is important to key in on target species that will use the placement site. An excellent example is the Nott Island site in the Connecticut River, CT, where a mixture of grasses and legumes was planted as a nesting and grazing meadow for waterfowl, deer, and small mammals (Landin, Webb, and Knutson 1989) (Figure 5-28). Although an animal's habitat consists of a wide variety of components, vegetation is by far the most important. Vegetation growth form, height, density, placement, diversity or uniformity, seasonal changes, biomass, and hardiness strongly influence species composition, abundance, and well-being of wildlife. Secondary objectives of recreation, aesthetics, erosion control, and soil quality also depend in part on vegetation. These relationships make it necessary to begin consideration of the ultimate vegetation of the site early in the planning process. Three methods of upland vegetation establishment exist: allowing natural plant invasion and establishment, planting selected species, and combining natural establishment with planned propagation.



Figure 5-28. Nott Island Habitat Development Site, Showing the Planted Nesting and Grazing Meadow as it has Appeared Since 1981

5.23.3.1 Natural invasion and establishment. The ability of propagules to reach the upland site is the most important factor in describing the potential for natural colonization on dredged material. This ability increases as the distance from a propagule source decreases and as the size of the site and ease with which the propagule can be transported increase. Propagules may be transported over a distance by wind or water; by attaching themselves to an animal's fur, feathers, or feet; by being ingested and excreted by an animal; or by attaching to a human. Secondary factors in the potential for natural colonization include physical and biological features of the site itself. Plants growing and reproducing on the site will reestablish after deposition of dredged material if the deposit was not too thick and if new substrate conditions are not prohibitive. Plants growing and reproducing near the area will establish only if seeds blow or are carried onto the site, if rhizomes or other vegetative reproduction forms extend onto the site, and if the new substrate conditions are not prohibitive.

5.23.3.2 Planting selected species. Standard practices in agronomy are usually sufficient to handle plant propagation on upland sites. With appropriate planning and management, any site can be vegetated within a few years and most sites within a year. Planting upland sites ensures that desirable vegetation grows there, that substrates stabilize rapidly, and that aesthetic appearances of placement sites improve faster. The chief disadvantage over natural invasion is the cost involved with site preparation and plant propagation and establishment.

5.23.3.3 Combining natural establishment and planting. A combination of the two methods of vegetation establishment may be beneficial: allow invasion to stabilize the substrate and start

modifying the sediments, then plant a different type of vegetation when the season or timing or soil conditions are more suitable. The reverse is also possible: to get immediate benefits of selected plantings, plant the site, then allow the site to proceed in natural successional stages. In addition, use of subsequent dredged material placement to set back vegetation succession to a more desirable stage is possible.

#### 5.23.4 Selecting plant species and propagule type.

##### 5.23.4.1 Selecting plant species.

a. If the site is to be planted, advance consideration must be given to the plant species that will create the desired habitat for the target wildlife species. An initial selection of species should be made during the planning phase even though once the site is established, alternate species may prove to be more acceptable and be substituted for those originally selected (Landin 1978). Numerous species are suitable for planting upland dredged material sites (Landin 1978). Coastal Zone Resources Division (1978) identifies, by state, 250 species or species groups that are of benefit to wildlife and adapted to grow on dredged material, and it presents species growth characteristics, habitat requirements, ranges, and tolerances of 100 of these. Lee, Sturgis, and Landin (1976) identify 50 species generally useful for dewatering and decontaminating dredged material; Mann et al. (1975) give growth characteristics of many tree and shrub species suitable for confined upland placement areas; and Coastal Zone Resources Corporation (1976), Landin (1978), and Soots and Landin (1978) summarize data on plants known to grow on dredged material sites. Further information on both upland and wetland species that grow well on dredged material is given in Environmental Laboratory (1985) and Thunhorst (1993). Appendix E, “Common and Scientific Names of Plants and Animals Mentioned in this Manual,” and Landin (1978) provide tabular information on numerous upland and wetland species and how to propagate them.

b. Other species of more local character are available, and many species with unknown tolerances and adaptability may prove useful after field testing. The NRCS is able to provide updated information on species and new varieties. Selection of species or species mixtures to be planted at a particular placement site must consider project goals, climate, substrate characteristics, plant species characteristics, plant species availability, ease of propagation, management requirements, and costs. Certain species mixtures, such as a nitrogen-fixing legume and a grass species, are commonly planted to take advantage of the different properties of each although, occasionally, the mixture is not successful because of interactions among the species or because the soil is too acidic, infertile, or compacted. Lime is generally required on dewatered dredged material to raise pH to a level sufficient for optimum plant growth.

5.23.4.2 Selecting propagule type. Hunt et al. (1978) and Landin (1978) give the best propagule types for selected plant species based on criteria of availability and cost, ease of collection and handling, ease of storage, ease of planting, occurrence of disease, and need for rapid vegetation establishment. In general, seeds are cheaper and easier to work with than vegetative propagules such as cuttings, sprigs, or seeding in upland habitats. However, some plant species and planting situations require vegetative propagules—for example, to rapidly stabilize

the exterior of a sand dike. Often, on dry dredged material, nursery crops or mulches for shade and organic material additions are essential for survival of the desired plant species.

5.23.4.3 Handling plant material. If commercial seed sources are not available, collection and storage of wild seeds should follow the guidelines in Hunt et al. (1978). Some desirable species are available as transplants (potted, balled and burlapped, or bare-rooted nursery stock). However, many native upland plants that are desirable as long-term cover and food sources for wildlife are not commercially available for purchase.

#### 5.23.5 Preparing and planting the site.

5.23.5.1 Substrate modification. Once the dredged material has been placed and dewatered sufficiently to allow equipment access, it can be modified as necessary. Modifications are usually directed toward preparing the substrate for vegetation establishment, and they depend on the condition of the substrate and the exact design of the project. In upland habitats, these activities are largely agronomic, and typical farm equipment can be used.

a. Mechanical modification. The site may require grading to change the topography that resulted from placement—for example, to make the slope uniform by removing depressions or mounds, increase relief by making depressions or mounds or altering the slope, make islands, or raise low spots. Variation in texture of the sediments results either intentionally by placement of more than one type of material or naturally through hydraulic sorting during placement. This variation may need to be reduced to a more uniform soil for seedbed preparation. This can be done by repeated passes with a blade or deep plowing followed by disking. If possible, grading should be done at the time of year when precipitation is lowest to reduce erosion of the bare soil. Seedbed preparation includes plowing or disking one or more times to break up clumps and aerate the soil, fill or cover desiccation cracks, even out moisture content, destroy unwanted vegetation that may have invaded, turn under green manure, incorporate soil amendments and, in general, improve the quality of the substrate. Preparation is best done several months prior to planting and again just before planting, if labor and equipment are available. Success of the site may especially depend on this process.

b. Chemical modification. Prior to final mechanical seedbed preparation (preferably several weeks to months ahead), the substrate at the site should be sampled and the soils analyzed chemically in the same fashion as for site characterization. Their chemical properties may have been altered by dredging and dewatering since the initial tests. Some of the common problems that may be found include high salinity levels, soil acidity or alkalinity, or lack of one or more of the essential plant nutrients at levels sufficient to support good plant growth. These can be corrected with soil amendments, leaching, or other techniques (Hunt et al. 1978; Landin, Webb, and Knutson 1989).

c. Biological modification. Biological modification of the substrate may also aid in the success of the project. This could include such things as removal of existing and competitive vegetation by cutting, short-lived herbicide application, or cultivation; growth of a preliminary green fertilizer crop; or addition of farmyard manure, sewage sludge, and other organic materials on light-textured sands to improve their nutrient- and moisture-holding capacity. If legumes are



to be grown on the site, the seed should be inoculated with the proper strain of *Rhizobium* bacterium to improve chances of fixing adequate amounts of atmospheric nitrogen.

5.23.5.2 Timing. Timing of all factors related to plant establishment is an important consideration in habitat development. Adequate planning will have allowed lead time to locate, obtain, and prepare sufficient amounts of viable seeds or vegetative propagules, including any period of seed dormancy. Timing of planting also strongly influences plant success. For example, seeding warm weather annuals before the last cool period in spring will result in heavy crop damage, but seeding the same species in midsummer will result in heat and drought stress during sprouting. Seeding of cold weather species too early in the autumn will result in sporadic germination, increased chances of insect infestations such as army worms, and heat and drought stress. Optimum seeding times vary with climatic regions and photoperiods, and local agronomic authorities should be consulted before planting. Refer to Hunt et al. (1978) and Landin (1978) and Appendix E, “Common and Scientific Names of Plants and Animals Mentioned in this Manual,” for species-specific details on timing.

#### 5.23.5.3 Planting.

a. Temperature. Vegetative propagules may be planted any time the ground is not frozen and any time the day temperatures average less than 20° C. In general, March to May is best for warm weather plants and September to November for cold weather plants over most of the United States. In the Deep South, transplanting is usually done successfully from October through May, with June through September being too hot. Dormant propagules may be more readily transplanted in winter months. Propagules held in storage inside a nursery or greenhouse should not be planted until temperatures at the field site are approximately as warm as the storage area to lessen shock. Propagules held in a shady area should be gradually acclimated to sunny conditions, if the site is in the sun, to prevent blistering and death of leaves and plant shock. General planting methods are given Hunt et al. (1978), Landin (1978), and Hayes et al. (2000); specific recommendations for local conditions can be obtained from the NRCS or county extension service agents.

b. Methods. Methods of planting vary with the propagule type. Seeds should be sowed in a well-prepared seedbed that has been plowed and/or disked to a depth of at least 15 cm (6 in.). It is important to consider planting techniques, equipment seeding rates and depths, and seed and soil treatments when using seed propagules. For transplants, types of propagules, planting techniques and equipment, transplant spacings, timing of planting, plant growth habits, and long-range project goals are all important factors in determining site success (Hunt et al. 1978).

5.24 Engineering Design of Upland Sites. Guidelines for substrate design and sediment protection and retention apply to both a new placement area and one that may already have a retention structure and some material placed. Design should be based on information gathered during the site description, on results of field and laboratory tests, and on the requirements for the planned habitat development. The majority of the information in this section was compiled from Eckert, Giles, and Smith (1978); Hunt et al. (1978); Palermo, Montgomery, and Poindexter (1978); and Hayes et al. (2000). Dredged material may be placed by either hydraulic or mechanical methods. The hydraulic pipeline dredge is the most commonly used and will continue to be

the major source of dredged material to be used for upland habitat development. Hydraulic transport of material assumes additional prominence when one considers that dredged material handling systems, involving direct pump-out of hopper dredges, temporary containment basins, or bucket-loaded scows, usually involve final disposition by pipeline. The pipeline dredge can dispose of material in upland areas through the use of shore lines or shallow-draft floating pipelines.

#### 5.24.1 Substrate design.

5.24.1.1 Elevation. Substrate design for upland habitat development includes determination of site elevations, slope, orientation, configuration, and size (area and volume). The design must provide for placement of dredged material to a stable elevation within the desired elevation limits, allowing for settlement due to consolidation of both the sediments and foundation material. For fine-grained sediments, the substrate must be designed to provide adequate surface area and retention time for sedimentation of suspended solids. Procedures for substrate design generally follow those established by Montgomery (1978) and Palermo, Montgomery, and Poindexter (1978) for the design of conventional containment areas. The determination of substrate elevation is governed by two limitations: the project requires placement of a given channel sediment volume, and the size to handle this volume within elevation limits must be determined; or the project requires a substrate to be constructed within given size limits, and the volume of channel sediment to construct this substrate must be determined. In either of these cases, a correlation between in situ sediment volumes and volumes occupied by the dredged material must be determined. The first step is to calculate void ratios by determining water content of samples of the sediments to be dredged. The second is to compute the void ratio of the dredged material after dredging and deposition (Montgomery 1978; Palermo, Montgomery, and Poindexter (1978).

5.24.1.2 Sedimentation of solids. Confined placement areas with primarily fine-grained dredged material should be designed to retain solids by gravity sedimentation during the dredging operation. Solids retention is directly affected by the size of the confinement area (particularly length and depth), inflow rate (dependent on dredge size and operation), physical properties of the sediment, and salinity of the water and sediments. Montgomery (1978) and Palermo, Montgomery, and Poindexter (1978) detailed separate design procedures for determining sediment retention time requirements for fresh and saline sediments with continuous placement. In addition, these procedures include factors influencing efficiency of the substrate containment, effects of short-circuiting, ponding depth, weir placement, and shapes of containment. In the event that substrate containment does not provide an adequate gravity sedimentation basin, then one of the following alternatives must be exercised:

- a. The size of the site must be increased.
- b. A smaller dredge must be used.
- c. Intermittent dredging and/or placement operations must be initiated.

5.24.1.3 Weir design. Retention structures used to confine dredged material must provide a means of releasing carrier water back into the waterway, which is best accomplished by placing a weir within the containment area. Effluent quality can be strongly affected by the design and operation of the discharge weir, with the weir length and ponding depth having the greatest control on this quality. Walski and Schroeder (1978) developed a design procedure for defining weir length and ponding depth to minimize the discharge of solid particles into the waterway.

5.24.1.4 Dredged material settlement. Settlement occurs following completion of the dredging operation because of the self-weight consolidation of the dredged material layer and/or the consolidation of compressible foundation soils. Estimated settlements may be determined by procedures presented by Palermo, Montgomery, and Poindexter (1978). Once loading conditions are determined, ultimate settlements that occur after the completion of 100% primary consolidation can be estimated from laboratory consolidation data. This settlement is not as critical as for wetland habitats, but it is important because of the ponding effect it causes. Time rates of consolidation for both the dredged material and foundation soils are required to determine the relationship between the desired final substrate elevation and time. If the data from the laboratory tests reveal that settlement will not meet desired elevation requirements, an adjustment to the substrate configuration must be made to raise or lower the initial substrate elevation as required.

#### 5.24.2 Substrate protection and retention.

5.24.2.1 Requirements for a structure. Data gathered for the site description should be used to determine if a protective or retention structure will be needed for the upland site. Engineering data collected at a specific site should determine the amount and character of the material to be protected or retained, maximum height of dredged material retained above the firm bottom, degree of protection from waves and currents required, duration of the structure, foundation conditions at the site, and availability of construction material. All habitat development sites may require a structure for protection of the perimeter from erosion caused by currents, waves, or tidal action. However, particular concern should be given to the effects of any proposed structure on existing current or wave patterns. For example, a structure positioned so that it constricts the water flow will increase local current velocities or reflect wave energies, and thus may encourage erosion. All habitat development sites may require structures for retention of the dredged material to allow it to consolidate, to control the suspended solids content of the effluent, or to protect surrounding habitat or adjacent structures. Site hydraulics, the properties of the sediment to be dredged, the time over which placement occurs, and the existing site characteristics are closely interrelated in determining the need for such structures.

5.24.2.2 Selection of a structure. The protective or retention structure should meet four conditions:

- a. Suitability to the project goals of dredged material placement and habitat development.
- b. Practicality and ease of construction.

c. Ease of maintenance.

d. Reasonableness of cost.

Eckert, Giles, and Smith (1978) and Chasten et al. (1993) evaluated several protective and retention structures considered technically feasible for use in terrestrial habitat development and present information on structure selection, applicability to specific site conditions, and conceptual procedures for design and construction. The most feasible structures are often dikes constructed from filled geotextile bags or from sand in moderate-to-low wave energies in temperate climates (Eckert, Giles, and Smith 1978). The term “fabric bag” covers products from several producers of sack-like containers that can be filled with sand, sand-cement, or concrete and that are used as building blocks for breakwaters, groins, revetments, or containment dikes. Rock and rubble from new-work dredging can also be used. Geotextile factory custom-made tubes are being used more frequently for multiple purposes and are of value for a wide range of dredged material beneficial uses (Davis and Landin 1997).

5.24.2.3 Design of a structure. EM 1110-2-1902 and EM 1110-2-2300 provide proven methods for design and construction of earth- and rock-filled structures. Those procedures should be used to supplement engineering considerations of elevation requirements and earth and water pressure forces. Internal structures may be advisable. Cross and spur dikes are used to control circulation within a placement area, with the cross dike commonly employed to divide large placement areas into smaller cells, and spur dikes employed to interrupt direct slurry routes between the inlet and outlet. The cross dike is the more significant of the two structures for habitat development purposes since use of a cross dike allows flexibility in placement including incremental filling and separation of dredged material by grain size. (See Section XII, “Multipurpose Uses an Other Land Use Concepts,” for rippapped structures and cross dikes used at an upland habitat site.)

5.24.2.4 Construction of a structure. Site-specific factors affecting construction techniques are equipment accessibility, wave and current conditions, tidal range, water depth, bottom conditions, and distance from the dredging site (Eckert, Giles, and Smith 1978; Chasten et al 1993; Davis and Landin 1997). The construction material used and method of construction are significant factors. In addition to the fabric bags previously discussed, three basic types of retention structure construction exist: hauled dikes, cast dikes, and hydraulically placed dikes (Hammer and Blackburn 1977). Construction techniques for retaining walls, sills, breakwaters, gabions, and other structures are highly site specific and should be determined on a case-by-case basis (Hammer and Blackburn 1977).

5.25 Ecological Design of the Upland Sites. Planning for a habitat development site should be based on sound ecological principles and should attempt to make efficient use of available resources in reaching the goal. The two major resources that can be manipulated for habitat development are substrate (in this case, dredged material) and vegetation. All previous aspects of planning should be united in the ecological design of the site for proper placement of dredged material and vegetation.

5.25.1 Placement of dredged material. Many aspects of the engineering design of an upland placement site are directly related to the potential biological characteristics of the site. Physical appearance of the site is particularly important, and structures, configuration, size, elevation, topography, timing, and site interaction with surrounding habitats must be considered for ecological integrity of the upland site.

5.25.2 Placement of vegetation. Presence or absence and patterns of vegetation are critical factors in habitat development (Smith 1978; Soots and Landin 1978; Landin 1992b). Such ecological concepts as structural diversity, community size, species patterns of abundance, and biotic succession are pertinent. Specific concepts that should be applied to upland habitat design are diversity, ecological succession, habitat patterning, and vegetation structure and function.

## 5.26 Dredging and Placement Operations.

5.26.1 Construction. The first step in construction of an upland habitat development site is to build a protective or retention structure, if one is called for in the project design, or to modify an existing structure or site (for example, to raise a dike or add drainage). Some site preparation may be necessary, perhaps construction of an access route or removal of vegetation. Access for equipment and pipes should be built to minimize damage, especially to wetlands. Unless the project calls for shallow placement and recovery of plants present on the site, vegetation to be covered should be mowed or cut to prevent recovery after placement or to prevent dead branches and shrubs from protruding. Clearing and grading are required along the dike alignment to allow construction.

5.26.2 Dredged material placement. A significant amount of material rehandling is sometimes required in developing upland habitat because the final distribution of material at the site is important. This handling can be reduced if the initial location and distribution of the coarse- and fine-grained fractions of the dredged material are controlled. One means of control is to take advantage of the differential settling characteristics of the various-sized particles in the dredged slurry. Another means is to operate the dredging plant and peripheral equipment in a manner that will produce the desired substrate (Bartos 1977b; Hayes et al. 2000). For the majority of placement operations, the criteria for locating the discharge pipeline in the placement area have been to maintain an adequate flow distance relative to the weir, keep the discharge end of the pipeline a safe distance away from the interior slope of the dike, and minimize the pumping distance from the dredge. The criteria are directed at preventing short-circuiting or channelization of the flow through the containment area, avoiding scouring damage to dikes, and minimizing pumping costs. Some modifications of these pipe location criteria may be required if advantage is to be taken of particle size differential settling characteristics for habitat development. Coarse-grained material encountered during dredging operations can be taken advantage of with end-of-pipe operations. If the character of the sediment-water slurry being transported is known beforehand or can be determined by monitoring at the dredge or at the end of the pipe, then the coarse material can be diverted by use of a wye connection without interrupting the dredging operations or the dredging sequence. The diverted material can be placed directly in the desired location hydraulically or stockpiled for later use in habitat development. Stockpiling and

31 Jul 15

subsequent rehandling of the material are roughly equivalent to obtaining the material from a source outside the placement area and involve the use of additional or supplementary equipment.

5.26.3 Containment area operation. Activities during substrate material placement are aimed at the retention of solids and production of an effluent that will meet criteria for release into the waterway. Operational difficulties, such as channelization of the dredged slurry and insufficient ponding depth, may result in excessive amounts of solids leaving the placement area through the weir. This is counterproductive and usually violates laws and regulations. Therefore, it is recommended that during and after the placement operation a well-planned monitoring program be implemented to ensure that suspended solids in the effluent remain within acceptable environmental limits. Suspended solids retention can sometimes be increased by increasing ponding depths through efficient operation of the weir. Concepts of containment area management instituted immediately following the completion of a placement operation are also important to successful implementation of a habitat project. The most important aspect of dredged material placement area management is to remove all surface water as fast as possible to enhance surface drying (Bartos 1977b). This principle can be extended to include terrestrial habitat development since extensive site activity must usually wait until the substrate is trafficable. In addition, working the area to a gentle slope toward the effluent point allows efficient drainage of surface water and evaporative dewatering can be supplemented by transpiration by vegetation.

5.26.4 Quality control. Specifications for all phases of construction should be detailed and clear. Thorough inspection of all operations ensures that the work is in compliance with plans and specifications for upland habitat development and any mitigation requirements, and that means fewer post-dredging operations and lower project cost.

## Section VI

### Island Habitats

#### 5.27 General.

5.27.1 One hundred years of active dredging operations by the USACE, State agencies, and private industry have resulted in the creation, by placement of dredged material, of over 2,000 man-made islands throughout U.S. coastal, Great Lakes, and riverine waterways (Landin 1980) (Figure 5-29), and in subsequent years, the restoration and repair of a number of these islands (Landin 1992b, 1998a). These islands are of varying sizes and characteristics, and they and presently range in age from the newly formed to those that are part of the U.S. Intracoastal Waterway System and that are estimated to be 70 years old to a few that are documented to be well over 100 years old. Although the majority of the islands were made by the USACE, many are owned or managed by other Federal agencies, State governments, conservation organizations, or private citizens. The USACE continues to maintain an interest in these man-made islands because of its responsibility in using environmentally acceptable placement methods and sites, the continuing need for placement sites, the need for wildlife habitats in waterway areas, and the recreation potential of the islands (Landin 1980; 1997c; Lunz, Diaz, and Cole 1978). The rapid increase in the U.S. population and the corresponding demand on natural resources have helped to cause a gradual change in the use of the islands by wildlife and a need for reassessment of their

role as habitats. Natural sites have been altered and occupied by man through industrial, housing, and recreational development to such a large extent that some areas of the United States no longer have coastal islands that are still suitable wildlife habitat. Dredged material islands have provided this vital habitat in many areas.



Figure 5-29. A Dredged Material Island in Florida, Typical of Those Built in the U.S. Intracoastal Waterway

5.27.2 The primary wildlife species needing dredged material islands as part of their life requirements are 37 species of colonial-nesting waterbirds: pelicans, cormorants, anhingas, herons, egrets, ibises, spoonbills, gulls, terns, and skimmers. Several of these species are rare, threatened, or endangered throughout large parts of their ranges (Figure 5-30). While some of these species nest on dredged material beaches (for example, the largest coastal least tern colony in the United States on man-made beaches at Gulfport, MS) and isolated wetland woods, most often they seek the isolation from predators offered by islands. An estimated 2 million are annually nesting on over 700 of these dredged material islands in U.S. waterways, especially along the Atlantic and Gulf coasts from Long Island to Mexico, in the Great Lakes and, to a lesser extent, in lagoons and bays in California, the Columbia River, Coos Bay, and Puget Sound. Islands can offer these birds protection from ground predators, seclusion from man, and nesting substrates similar to those found in traditional nesting sites. The birds are especially vulnerable during the nesting season when they concentrate for several months in colonies and remain in them until their chicks have fledged. These water birds are protected by Federal laws since they are migratory species.



Figure 5-30. Endangered Brown Pelicans Nesting on Gaillard Island, Their First Nesting in Alabama in over 100 Years

5.27.3 In general, the correlation between increases in human populations and decreases in water bird populations holds true. The only exceptions exist when alternate habitats such as dredged material islands become available. Huge declines in water bird numbers have stabilized somewhat, partly as a result of the creation of islands, and without which waterbird populations would be 50% or less of present levels (Soots and Landin 1978). Detailed research and discussion on islands built of dredged material are presented in Landin (1980, 1992b) and Soots and Landin (1978). Guidance for selection of island development as a placement alternative is presented in Figure 5-31, taken from Soots and Landin (1978) and Landin (1992b), and details for the selection process are presented in Smith (1978).

5.28 Island Development and Management. Although many colonies of birds presently are nesting on dredged material islands, numerous characteristics of these islands could be improved by management to enhance the available habitat, and dredging operations can be altered in several ways to benefit the numerous sea and wading birds and other wildlife on dredged material islands. Development and management of dredged material islands for avian wildlife also usually provide essential habitat for smaller mammals and rodents that use the islands and cover a broad spectrum of techniques. In some cases, small mammals may act as bird predators, so their colonization should not be encouraged.



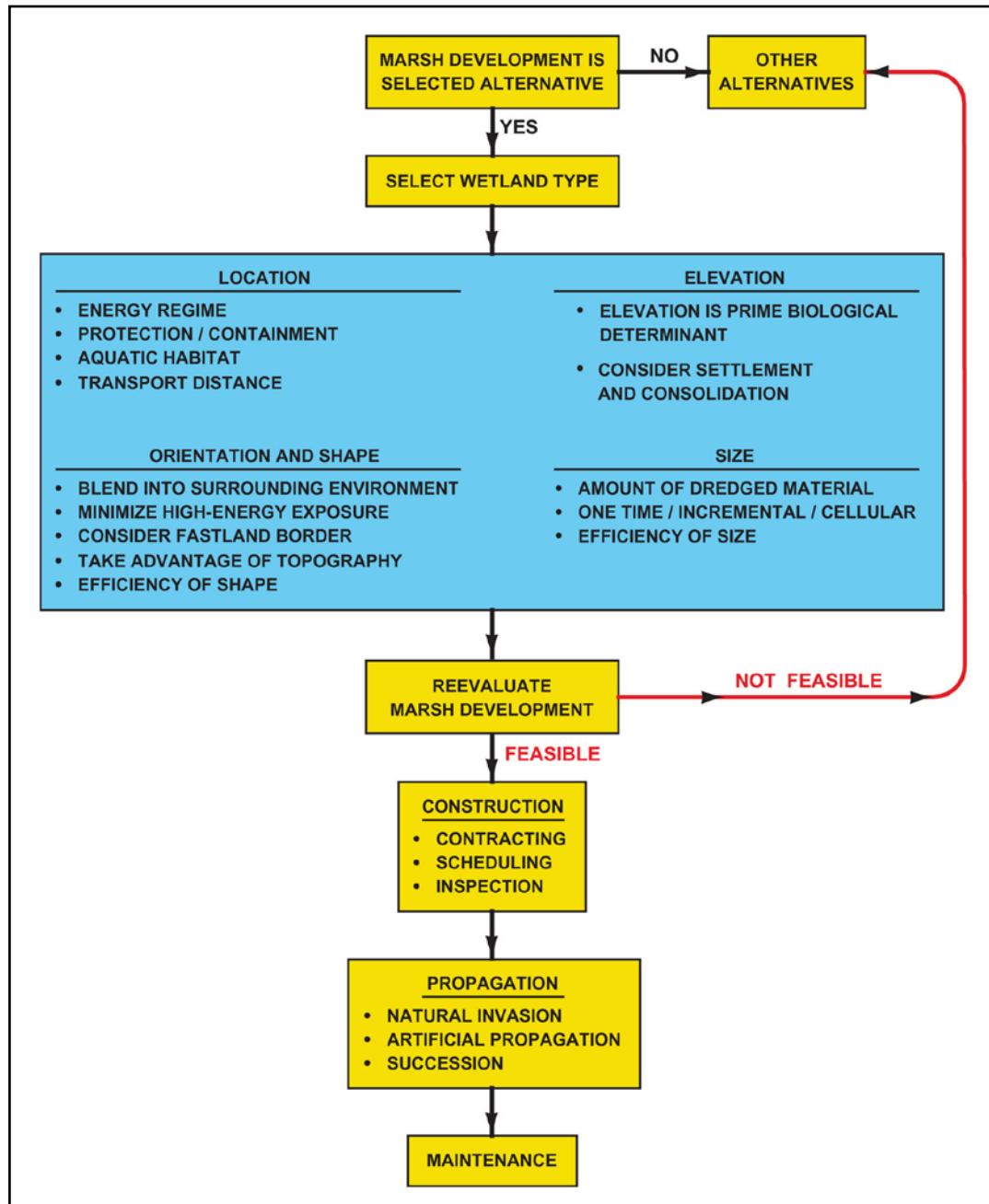

Figure 5-31. Guidelines for Selecting Island Habitat Development

### 5.28.1 Habitat changes.

5.28.1.1 Basically, development/management of an island for colonial sea and wading birds is concerned with habitat manipulation, habitat establishment, and habitat protection. Manipulation of habitats, by far the most likely technique to be used by engineers, includes proper placement of dredged material to maintain or reestablish habitats, increase the size of existing islands, and/or change configuration, elevation, vegetation, and other features for more desirable habitats. Manipulation of habitats includes, for the biologist, establishment of new

vegetation and management of existing vegetation on islands through various agronomic and horticultural techniques.

5.28.1.2 Establishment of new habitats is desirable when nesting habitat is lacking and new islands must be created, with the resulting need for vegetation establishment; when nesting habitat is expanded by an addition to an existing island that must be established with vegetation; or when undesirable nesting habitats (vegetation) occurring on islands must be cleared out and desirable habitats established in their place.

5.28.1.3 Habitat protection may be accomplished by island posting or fencing for isolation. Most bird species are already protected by law, but their habitats are not protected except during the time they are occupied by the nesting birds. Year-round protection to prevent destruction of habitat from year to year and seasonal protection to prevent nesting colony disruption by humans and predators are necessary.

5.28.1.4 Management of existing islands has been demonstrated to be an effective placement technique and wildlife management practice. Considerable potential exists for the placement of dredged material and the creation or improvement of avian habitat. Management of existing dredged material islands is most desirable because the potential environmental impacts of disposing on an existing site are less than those of developing new islands.

#### 5.28.2 Use of dredging operations on existing islands.

5.28.2.1 The USACE has provided habitat incidental to project purpose since the agency first created dredged material islands. The oldest dredged material island on record is Jetty Island at Everett Harbor in Puget Sound, built in 1891 and used by seabird colonies, including Arctic terns, for nesting. Since those early days, islands have been kept in various stages of plant succession through dredged material deposition from channel maintenance operations. These operations can have a significant positive impact on water bird breeding populations (Figure 5-32). Through proper planning the positive impact of regular maintenance dredging could be increased. Since past dredging operations have been carried out with little or no regard for nesting birds, many areas do not have adequate diversity of nesting habitats. Some areas lack ground nesting habitats while others lack woody habitats. Soots and Landin (1978) and Landin (1992a, 1997d) report habitat needs that could be satisfied by dredging operations in all the regions studied. Needs for bare ground nesting areas and more tree/shrub habitats exist on almost every part of the U.S. coast. The rate at which various habitats appear on an island after receiving dredged material and an estimate of their longevity have been determined (Landin 1980, 1992a, 1997d; Soots and Landin 1978).



Figure 5-32. Royal and Sandwich Terns Nesting on Dredged Material Islands in North Carolina, Where Successional Vegetation Stages are Deliberately Set Back with Placement Operations to Maintain Tern Nesting Habitat

5.28.2.2 Once site-specific needs are known, nesting habitat management can easily become a part of the regular maintenance dredging process. To maintain target habitat diversity for certain bird species, islands in any given area would have to be selected to receive periodic depositions of dredged material. Restrictions against dredged material deposition on all or parts of some islands may be necessary in order to allow habitats for tree-nesting birds to develop or to preserve existing tree habitats (Figure 5-33). The feasibility of these management recommendations has already been demonstrated by the Wilmington District. They have been practicing such management on a local, annual basis for several years and have developed a long-range colonial sea and wading bird management plan for the lower Cape Fear River estuary that includes maintenance dredging and placement and timing of dredged material depositions on existing islands and environmental guidelines for their dredging inspectors.

31 Jul 15



Figure 5-33. Wading Birds—Ibis, Herons, and Egrets—Nesting in a Maritime Forest in North Carolina

### 5.28.3 Building new islands.

5.28.3.1 Construction of new islands would be desirable under some conditions. If it has been demonstrated that there is a need for nesting habitat in an area lacking suitable islands, and if the benefits for the birds will exceed any negative effects of construction of an island to benthic organisms and current flow, then an island could be built. However, islands should not be placed in areas where they would be used for recreational purposes during the breeding season, thus eliminating or severely reducing their wildlife value.

5.28.3.2 In most areas there is no need for more islands for colonial nesting birds or other forms of wildlife. Management of existing islands should be given first priority. There are areas, however, where additional nesting habitats would be beneficial, and existing dredged material and natural islands are not available to fulfill that need. Establishment of need should be determined by consultation with knowledgeable wildlife biologists or by field studies. Generally, construction of new islands for wildlife is not feasible unless it can be demonstrated that the anticipated positive impacts on the target species outweigh any negative impacts on the environment. However, it would be desirable to construct a limited number of new islands in various regions of the United States for study purposes and to obtain baseline data. As more natural sites are taken over by man, strategic placement of new sites may become more valuable as a management tool. The present knowledge of bird utilization is based primarily on empirical and trend observations of existing dredged material islands, and more baseline data are needed on

species-specific success and long-term utilization based on ongoing dredging and navigation operations.

5.28.3.3 In addition to establishment of need, the feasibility of new island construction depends on the concerns of Federal and State agencies and the private sector. These concerns vary considerably among the regions of the country. However, it has been proven that construction of new islands for birds and other forms of wildlife is feasible. The Wilmington District constructed two islands in Core Sound, NC, one of which, Jimmy Wells Island, remains (Figure 5-34). The USACE Engineer Research and Development Center (ERDC) has also built or modified several islands for habitat development. The two North Carolina islands were unique in that they were the first to be constructed and were placed in such a manner as to deliberately create habitat for colonial seabirds and aquatic life; they were retained by the use of large geotextile sand-filled bags/tubes. The sites were designed so that during future maintenance dredging of the nearby navigation channel, material could be added to them within the existing sandbag retainers, and more sandbags could be added to create higher retention dikes. The kidney shape of the islands formed a small cove, where it is expected that a marsh will develop and benthic organisms will thrive. Marsh around the island was given a boost by the planting of smooth cordgrass and saltmeadow cordgrass around the perimeter. The islands were placed in an area with adequate shallow water and food resources but with a scarcity of bare-ground nesting habitat. Gull-billed terns, common terns, least terns, and black skimmers nested on the islands during the first breeding season after construction. Unfortunately, the bags/tubes were slashed by vandals almost as soon as construction was completed, and one of the islands failed. A number of islands have now been built in Florida, Alabama, Texas, Louisiana, California, and the Great Lakes with water bird habitat development as a secondary project goal.

5.28.3.4 Site location of an island should be worked out with knowledgeable wildlife biologists and concerned agencies to establish the best location. Building an island in an area that does not conform to the biological and engineering specifications outlined herein would fail to produce the desired wildlife habitat. The islands must be placed where the birds will be isolated from predators and human disturbances, unless the islands are going to be actively protected by wardens. With active protection, colonies of sea and wading birds have been successful close to human activities and have provided tourist attractions that could be observed from outside the colony (Landin 1980, 1992b, 1997c).

5.28.3.5 Timing of island development is important. Ideally, an island should be built during the fall or winter preceding the initiation of the next breeding season. The birds generally do not use a site until after the initial sorting of fine materials by wind and water. If it is built in the spring, this sorting will not have had time to take place, and any colony of birds trying to nest there may not be successful. Their eggs may be covered by drifting fine material. In addition, they cannot use a site until it has had adequate time to dewater.



Figure 5-34. Jimmy Wells Island, One of Two Dredged Material Islands Built for Seabird Nesting Habitat by the Wilmington District in Core Sound, NC, in 1977, is a Highly Successful Nesting Site, but it is Eroding and Needs a New Application of Dredged Material

5.28.3.6 The physical design of an island is important. In general, islands must be permanently emergent at high-water levels; birds have been found nesting on all sizes and shapes of islands as long as they meet this crucial breeding requirement. However, observations of hundreds of bird colonies on dredged material islands and the kinds of islands they select have led to four categories of recommendations: size, configuration, substrate, and elevation (Landin 1980, 1992b, 1997c). Whether an island is diked or undiked can make a significant difference in bird use (Parnell, Dumond, and McCrimmon 1985).

a. Ideally, new islands should be no smaller than 2 ha and no larger than 20 ha; however, birds have been found nesting on both smaller and larger islands, including islands 520 ha in size, dikes connected to the mainland on 1,840 ha sites, and other large man-made islands (Landin 1992b, 1997c). This is a highly site- and species-specific feature. Islands larger than 20 ha are generally difficult to manage and are also more likely to support predator populations, such as coyotes, snakes, foxes, feral cats and dogs, rats, and raccoons. Islands between the two extremes can be more easily managed, and considerable habitat diversity could be achieved on them. Generally, the greater the amount of habitat diversity to be maintained for wildlife populations, the larger the island should be.

b. The configuration of an island depends on the target wildlife species. Steep slopes, such as those found on dikes, should be avoided for all species. A slope no greater than 1 m (3 ft) rise per 30 m (100 ft) has been recommended (Soots and Landin 1978, Landin 1997c). Substrate configurations for the ground-nesting species are given in Soots and Landin (1978). Many bare

ground-nesters must have gentle slopes to prevent their eggs from rolling from nest scrapes. There is also evidence that the formation of a bay or pond with the island makes it more attractive to nesting birds (Landin 1980).

c. The general nesting substrate requirements of colonial bird species are given in Soots and Landin (1978). Generally, coarser materials like sand or cobble make better nesting substrates due to greater stability. Fine materials like silts and clays are subject to wind and rain erosion, and they usually have desiccation cracks, settling, and ponding. A mixture of sand and shell material makes good nesting substrate for most of the ground-nesting birds, which prefer sandy beach areas. These bird species historically nested on sandy beaches before being forced off by human use. Fine, unstable dredged material may be stabilized to form suitable nesting substrate by adding coarse materials like shells over its surface or by planting a ground cover on the material to provide vegetation for those species that prefer that kind of habitat, such as the Forster's tern or laughing gull. Tree-nesting species obviously prefer woody vegetation, and these trees and shrubs often colonize best on silty, more fertile substrates. Selected plant species of shrubs and trees, which are discussed in Soots and Landin (1978), Landin (1978, 1986), and Landin, Webb, and Knutson (1989), may be planted on the sites since there are several plant species that seem to be preferred over others by tree-nesting birds. If plant propagation is to be a part of a management scheme, these species should be given first consideration.

d. Elevations of constructed islands should be high enough to prevent flooding of the areas that could be used by waterbirds for nesting. However, elevations do not need to be so high that wind erosion will prevent the substrate from becoming stabilized. Generally, the optimal elevation for an island is between 1 and 3 m (3 and 10 ft) above mean high water. The desirable elevation to be achieved depends on the texture of the exposed dredged material, the wind exposure, and the habitat objectives or target species. Coarser materials may stabilize at higher elevations than finer materials. If islands can be constructed of coarser material for ground-nesting birds, then it is acceptable in some cases to exceed the recommended elevation. In general, the higher the elevation, the more slowly the island will be colonized by plants. Therefore, lower elevations to achieve plant cover for some ground-nesting species and all tree-nesting species should be considered where those are the target wildlife species and where substrates are of fine-textured material. It should be remembered that given the proper substrates and vegetation for nesting, none of the species using dredged material islands for nesting choose one elevation over another as long as they are above the tide or flood lines.

5.28.4 Dredged material island additions. Additions to islands may be a useful management tool if valuable nesting sites are altered by erosion until they have to be eventually abandoned. Additions to such islands prolong their usefulness as nesting habitats. Additions to islands covered with vegetation increase habitat diversity by providing some bare-ground habitat, at least temporarily, for those forms of wildlife requiring bare ground. For example, the Jacksonville District, in cooperation with the National Audubon Society, built an addition to Sunken Island in Hillsborough Bay, FL, during maintenance dredging operations in the 1970s. It was built as seabird nesting habitat, but needs continued applications of sand dredged material to maintain that habitat (Figure 5-35). In south Florida, additions may be done in such a manner that encourages growth of mangroves, an excellent nesting substrate for tree-nesting birds. Colonies

31 Jul 15

have responded favorably to island additions, especially bare-ground nesting species along the northern Gulf and Atlantic coasts.



Figure 5-35. An Addition Built by the Jacksonville District, in Cooperation with the National Audubon Society, to Sunken Island in Hillsborough Bay, FL, During Maintenance Dredging Operations in the 1970s

5.28.5 Confined Placement Facilities (CPFs). In the Great Lakes and a number of ports along the eastern and Gulf coasts, USACE Districts have constructed 51 large, permanent, diked islands for maintenance dredging; others are in the planning stages. These islands are sometimes over 400 ha in size, often well-armored and, in most, cases designed for permanent containment of contaminated sediments, especially along the mid-Atlantic to New York coast and in the Great Lakes. These islands are located up to 5 km (3 mi) from shorelines and are relatively isolated. From the time of their construction, they have been used increasingly by nesting and loafing seabirds. Jacksonville, Mobile, Detroit, Norfolk, Baltimore, Wilmington, and other USACE Districts considered seabird use in design and management on newer CPFs, and the seabird colonization has been spectacular in several cases. Management on CPFs generally consists of continued protective isolation, wildlife monitoring, and posting. Vegetation management has not yet become a problem on any of these islands more than 15-20 years postconstruction.

#### 5.28.6 Protection of bird colonies.

5.28.6.1 Since the primary users of dredged material islands are the sea and wading birds that nest in colonies, and the lack of isolation and protection is one of the primary problems these



birds face, this species group would be greatly benefited by the provision of protection of colonies and nesting areas. They are already protected by Federal law and regulation as migratory species. Since this does not protect habitat unless the migratory animal is present, it can sometimes be detrimental for long-term protection purposes. In addition, some states have laws and regulations designed to give protection. A number of endangered or threatened species nest in colonies on dredged material islands. It has been shown repeatedly throughout North America that, in general, protected colonies are successful and unprotected colonies are not due to habitat loss and disturbance. Every Federal and State agency and every individual has the responsibility to see that its actions are not in violation of laws that protect wildlife. To ensure compliance with the law, maintenance operations involving placement of dredged material should be conducted in a manner that does not disturb the bird colonies. Management should include proper care during placement of dredged material, surveying, and dike construction.

5.28.6.2 Public education concerning the vulnerability of colonial nesting birds has the potential of being a valuable management tool. Through various public affairs channels, the general public could be made aware of the value of dredged material islands to colonial birds. At the same time they could be informed that the continued placement of dredged material is a viable management option.

5.28.6.3 Other protective measures for colonies that are valuable management tools include posting of colonies with signs, such as those used by the Mobile and Portland Districts; fencing, designation of certain colonies as sanctuaries; responsible scientific study (and thus limiting disturbance of the birds by constant observation and measurements); and control of wildlife predators, such as raccoons, foxes, and feral cats, dogs, and rats.

#### 5.28.7 Vegetation on dredged material islands.

5.28.7.1 A number of suitable plant species can be planted on islands to increase their attractiveness to wildlife and, especially, to colonies of nesting sea and wading birds (Landin 1978, 1992b; Soots and Landin 1978). Depending upon the specific requirements of the wildlife species, a variety of suitable plants can be used in a management plan for islands. No plantings are necessary for ground-nesting species in most cases, although some of these species use sparse herbs and grasses for nesting. Since tree-nesting species require tree/shrub habitat, planting of this vegetation type on islands hastens wildlife use by more quickly providing suitable habitat. Woody habitat requires 5-30 years to develop, depending upon the region and climatic conditions.

5.28.7.2 Sometimes, vegetation on islands must be controlled in order to provide the proper or desired habitat for target wildlife species. Vegetation control is necessary if habitat for ground-nesting species is scarce and there is an abundance of other habitats or if the wrong species of trees is growing on an island, precluding nesting or other wildlife use. Some of the control methods that have been successfully tried on dredged material islands are mechanical removal (tractors, tillers, chain saws, axes), hand removal (pulling up plants by their roots), controlled burning, and applications of herbicides. Controlled burning is not very successful because new growth begins immediately after the area is burned although there are situations in which controlled burning is useful, such as when encouraging temporary movement of a colony during

31 Jul 15

construction activities prior to the beginning of nesting. Herbicides should be carefully applied according to directions; they have been found to be extremely effective on islands in North Carolina, but less so in Florida, where there is a 12-month growing season.

#### 5.29 Development and Management Problems.

5.29.1 Numerous potential problems may be encountered in building and/or managing dredged material islands. A key to success in the early planning stages is cooperation and coordination with Federal, State, and local agencies by regulatory authorities. Many obstacles to project success can be removed by correct planning and public awareness efforts before the project actually begins.

5.29.2 It requires considerable care to create specifications for developing an island from dredged material for habitat while simultaneously satisfying the need to dispose of a given amount of dredged material. To ensure that habitat plans are carried out, specifications should include exact locations and time of placement, size of deposit, elevation of deposit, and movement of dredge pipes. Onsite monitoring is highly desirable and is necessary when placement is on an island with an existing bird colony or population of vulnerable wildlife. The U.S. Army Engineer District, Wilmington (1996) wrote a dredging inspectors' environmental handbook that outlines how to accomplish beneficial uses and explains why these very tight specifications are necessary for fish and wildlife habitat and life requirement purposes.

5.29.3 Silt curtains (effective only in certain parts of the United States under certain soil conditions) or temporary dikes sometimes may be required in placement activities. If a dike is built on an existing island and filled, it should usually be at least partially removed or breached to allow ground access to water by young birds. This requires return to the site by earthmoving equipment. For best use by wildlife, dikes do not need to be erected until just prior to placement. Periodic monitoring to determine after-effects of placement will provide useful information for future placement efforts.

5.29.4 The public is seldom aware of specific wildlife needs. Severe damage can be inflicted on a colony by simply fishing or boating adjacent to an island during the nesting season through disturbance of the young and the adults. Surveying and dike construction activities can also disrupt nesting birds. Education of both the general public and dredging personnel is needed. An information program should be a part of every ongoing or planned dredging operation. Positive public opinion regarding placement operations of dredged material in North America may improve public acceptance and understanding of dredged material placement operations and allow more of this resource to be developed for the benefit of North American wildlife.

## Section VII Aquatic Habitats

### 5.30 General.

5.30.1 Aquatic habitat development is the establishment of biological communities on dredged material at or below mean tide in coastal areas and in permanent water in lakes and

ivers. Potential developments include such communities as tidal flats, seagrass meadows, oyster beds, clam flats, fishing reefs, and freshwater aquatic plant establishment. The bottom of many water bodies could be altered using dredged material; this has the potential of simultaneously improving the characteristics of the site for selected aquatic species and permitting the placement of significant quantities of material.

5.30.2 A number of applications of this alternative have been made by USACE Districts in recent years, including razorshell clam sites in the Portland District; gravel riffles for endangered species in the Tennessee-Tombigbee Waterway in the Mobile and Nashville Districts; razor clam and mussel habitat in the St. Paul and Louisville Districts (Landin and Miller 1988); artificial fishing reefs in a number of Districts; seagrass beds in California, Washington, Florida, and Maryland; and 21 underwater berms for storm attenuation, aquatic habitat, and beach nourishment. Numerous unsuccessful and partly successful attempts to establish sea grasses on dredged material have been made on the Atlantic and Gulf coasts, but have problems due to turbidity and shifting sediments. Only in southern California has the concept of sea grass restoration become routine, where several hundred hectares of eelgrass has been restored on dredged material (Merkle 1990).

5.30.3 The creation of an underwater berm using coarse-grained dredged material has been tested at Virginia Beach, VA, in the Norfolk District, and the site is providing habitat for overwintering blue crabs and other motile marine organisms from the Chesapeake Bay. This site not only provides aquatic habitat, but it also serves to protect the shoreline through storm wave dissipation and sand stockpiling for beach nourishment, and it allows a reduction in maintenance dredging in some tidal inlets. Two large underwater berms have been constructed as a national demonstration project off the Mobile Bay, AL (Clarke 1994). Data collected on the 40 million m<sup>3</sup> stable berm indicates that it is not moving and that it is providing protection from severe storms as well as refuge and habitat for numerous species of finfish and shellfish. The other berm, a feeder berm to nourish the beaches of Dauphin Island, was studied with tracers that indicated that the sand in that berm is moving directly onto the beaches as predicted. At the present time, 21 underwater berms are constructed of dredged material (Hands 1994). Three smaller berms have also been developed for aquatic habitat: Thimble Shoal, VA, in the Norfolk District; Kings Bay, GA, in the Jacksonville District; and Charleston Harbor, SC, in the Charleston District.

### 5.31 Aquatic Habitat Development.

#### 5.31.1 Introduction.

5.31.1.1 Because aquatic habitats have not been developed on dredged material in many locations, there are not sufficient data and research to allow some predictability of success and to provide guidelines for restoration, creation, and enhancement of these habitats using dredged material. Sea grass habitat development was first tested rigorously in Florida (Smith 1978; Thorhaug 1985), with a few examples in the Great Lakes, and several west, east, and Gulf coast locations. Although field tests and guidance have been ongoing since the mid-1970s, it is a still-developing concept with many unknowns about what is likely to be encountered or considered on

31 Jul 15

site-specific questions. Each aquatic habitat site should still be approached as a learning experience while field testing of guidelines continues.

5.31.1.2 In the late 1980s, the USACE entered into a formal Memorandum of Understanding (MOU) with the National Marine Fisheries Service (NMFS) to build and study sea grass development on dredged material deposits in North Carolina, Texas, and California. This study was concluded in 1995 although an informal agreement to continue to cooperate is still in place. These studies indicated that sea grasses were more productive than adjacent mudflats and equal to the productivity level of emergent tidal marshes, but predictability in techniques for planting in Atlantic and Gulf coast areas was still a problem.

5.31.2 Advantages. Several advantages to aquatic habitat development are recognized. It provides high biological production, has a potential for wide application in both coastal and interior waterways, complements other habitats, and provides habitat where none previously existed or had been eroded away or destroyed. Aquatic habitats are highly productive biological units. Sea grass beds and artificial reefs and berms are recognized as exceptionally valuable habitat features, providing both food and cover for many fish and shellfish. Oyster beds and clam flats have high recreational and commercial importance. Fishing reefs built on flat, relatively sterile lake, river, or bay bottoms provide habitat diversity, food, and cover as well as recreation for fishermen. Dredging material placement projects impacting aquatic communities predictably incur strong criticism and are seldom allowed. In these cases, reestablishment of similar communities where impacts occur may be feasible as a mitigation or enhancement technique. In many instances it may be possible to establish aquatic habitats as part of a wetland habitat development project. This concept potentially has very wide application as most dredging projects are flanked by open water. Often, selected subaquatic placement of material will both enhance the placement site and accommodate large amounts of dredged material. In the case of fishing reefs built of dredged material, the material is usually bedrock or rubble from new-work dredging operations suitable for reef formation. This kind of dredged material is also well suited for oyster and clam bed development since it gives larval oysters and clams places to attach.

5.31.3 Disadvantages. The primary and overriding disadvantage of aquatic habitat development is an inadequate understanding of techniques for applying this alternative, resulting in strong objections from fisheries agencies. Careful site-by-site determination, combined with local biological and engineering expertise, is necessary. Sea grass establishment through the early 1980s was primarily on disturbed sites that did not involve dredging (Thorhaug 1981, 1985), and its application to placement sites did not begin to increase until about 1985 (Merkle 1990). Development of freshwater aquatic habitat on dredged material has been limited to providing protective structures via barge-transported coarse-grained material to allow natural aquatic habitat development, and it has been compounded by the introduction of the exotic zebra mussel into U.S. waterways.

5.32 Guidelines for Aquatic Habitat Development. The ongoing development of specific engineering and environmental guidance on aquatic habitat development should not eliminate the consideration of this alternative. Phillips (1980), Thorhaug (1981, 1985), Uetz et al. (1979), Fonseca (1987), Fonseca et al. (1985), and Merkle (1990) provide guidance on aquatic habitat

development in coastal areas. Most aspects of habitat development presented in the preliminary assessment and the detailed evaluation of feasibility (Figure 5-13) are applicable to aquatic habitat development. Of particular significance are hydraulic energies along the bottom and water circulation patterns. The interaction of the texture of the material with the hydraulic energies of the site is extremely critical as the material must provide a stable surface substrate and a relatively clear water column. The possibility that alteration of the bottom configuration of a waterway could adversely affect current patterns should be carefully considered, especially with fishing reefs, protective structures for freshwater aquatic plants, and aquaculture structures. In large projects or in those projects where some question exists regarding the impact, it may be advisable to develop physical, chemical, and biological models of the aquatic system prior to project implementation. Sea grass projects that appeared to be successful have been lost due to turbidity, both seasonal and increasing on sites, in the water. Turbidity shades out and smothers sea grass beds.

5.33 Design of Sea Grass Habitat. There are a number of well-documented examples of subtidal sea grass habitat development on dredged material, primarily in the Caribbean, but also in southern California, Chesapeake Bay, North Carolina, and Florida. Reclaimed subtidal bottom was successfully revegetated by 1980 in Florida (Thorhaug 1981), and results from these projects can be applied to dredged material.

5.33.1 Transplanting techniques. Transplanting techniques are described in Thorhaug (1981) for south Florida. Merkle (1990) has successfully developed and refined his own techniques for southern California. Phillips (1980) has developed guidance for the Pacific Northwest, and Fonseca (1987) has developed guidance for the coastal southeastern United States. Figures 5-36 and 5-37 show a coring method of transplanting plugs, in this case, of shoal grass at Port St. Joe, FL, Figure 5-38 shows a bareroot propagule (the most efficiently handled and cost-effective type of propagule) of eelgrass, and Figure 5-39 shows turtle grass being transplanted into sand. Sea grass development can help stabilize dredged material through the binding action of roots and rhizomes and the dissipation of wave and current energy, thereby reducing erosion processes, although this is a fragile procedure.

5.33.2 Location. Sea grasses normally occur along shorelines and shallow coastal waters with low wave and current energies. Development of subtidal sea grass habitat in higher energy shallow-water areas requires permanent protection with breakwaters or planting within lagoons created within dredged material islands. This procedure has not been successful on the East Coast. Both subtidal and intertidal sea grasses occur in California; and from northern California into Alaska, sea grasses are primarily intertidal, occurring in conjunction with mudflats. Intertidal sea grasses have been successfully restored in Puget Sound, but with less success in San Francisco District. The most impressive results in sea grass restoration in the United States by far have been in southern California on dredged material (Merkle 1990).



Figure 5-36. Removing Plugs of Shoal Grass from an Existing Bed Near Port St. Joe, FL, for Transplanting on a Nearby Dredged Material Site



Figure 5-37. Temporary Storage for the Shoal Grass Plugs was Provided by Containers of Seawater, which were Transported to the Dredged Material Site by Skiff



Figure 5-38. A Bareroot Propagule of Eelgrass Ready for Transplantation

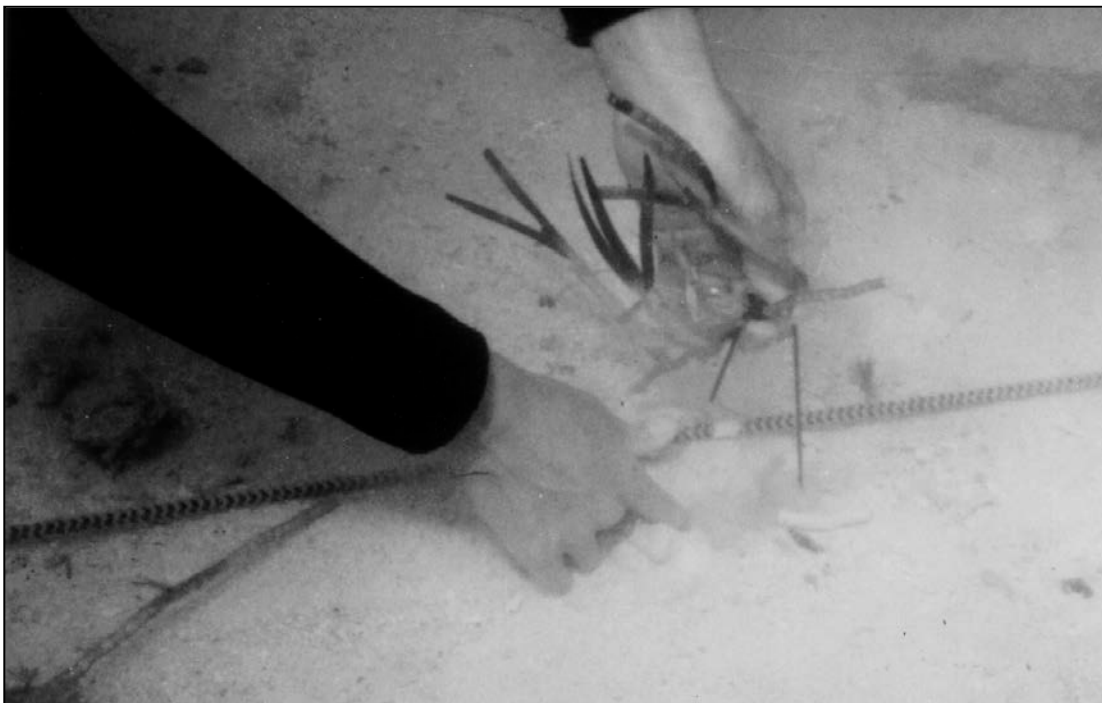

Figure 5-39. A Bareroot Propagule of Turtle Grass is Held in Place with a Long Staple after Being Transplanted on a Sandy Site to Prevent Waves and Currents from Washing it Out

5.33.3 Depth. Bottom elevations within sea grass beds extend from mean low water (intertidal) to -2 m (-6.5 ft) in estuaries, and -10 m (-33 ft) in coastal environments. Kelp is not

included in this discussion as it occurs in deeper marine waters and has never occurred on dredged material.

5.33.4 Water quality. Surveys and measurements to predict expected annual fluctuations in water quality at a site are required to assess suitability. Data should be collected as frequently as possible so that the site can be adequately characterized, and it could change from year to year and season to season. Presence of natural sea grass beds in the vicinity of a proposed site is also a strong indicator of general water quality suitability.

5.33.4.1 Light. The foremost requirement of all sea grass species is sufficient light penetration through the water column to support growth. High water column turbidity is an indication that a site is not suitable for habitat development.

5.33.4.2 Salinity. Most of the common species of sea grasses require salinities greater than 20 ppt, though some local variations may exist where plants tolerate salinities as low as 10-15 ppt. Widgeon grass will occur in brackish waters.

5.33.4.3 Temperature. Though sea grasses require relatively low energy environments, the area needs to be well flushed, and currents must circulate to prevent lethal temperature extremes.

5.33.5 Sediment type. Sediment grain size is not usually a limiting factor as most sea grasses can tolerate a wide range in sediment from coarse sand to mud.

5.33.6 Vegetation establishment.

5.33.6.1 Plant species selection. In most geographic regions, sea grass species selection is based on salinity although along the southeast Atlantic and Gulf coasts, where five sea grass species (eelgrass, shoal grass, widgeon grass, turtle grass, and *Syringodium filiforme*) generally occur, other considerations can be evaluated with higher priorities. In the southeast, environmental tolerances or species growth rate may be a prime factor in species selection (Lewis and Phillips 1981; Fonseca 1987).

5.33.6.2 Propagule selection. Sea grass habitat development is almost exclusively restricted to transplanting mature plants from a donor bed as nursery stock is currently unavailable. Mature plants reproduce by branching and by growth from meristematic tissues. Methods using seeds or seedlings have never been adequately developed because vegetative propagules are considered the least difficult propagation method.

5.33.6.3 Plant spacing. The rate at which sea grass covers a planted area depends on species growth rate and spacing of transplants. Some species are much faster growing than others. On most sites, seagrasses have been planted on 0.25-1 m (0.8-3.3 ft) centers. Spacing guidelines for East Coast species are given in Thorhaug (1981, 1985) and Fonseca (1987); spacing guidelines for West Coast species are given in Phillips (1980) and Merkle (1990).

5.33.6.4 Handling plant material. Plants need to be handled as carefully as possible to avoid damage to roots and shoots. Turtle grass meristematic tissue protection is critical for



reproduction of that species because the species cannot grow and divide without it. Short-term plant storage (not more than a few hours) can be in well-aerated containers while longer-term storage (a few days, but not more than 1-2 weeks) should be in floating pens or flowing seawater tables. Plants should never be directly exposed to sun and air for more than a minute or two, or they will be damaged.

5.33.6.5 Pilot propagation study. In a sea grass development project where there are unknown factors—such as water quality, rate of plant species spread, or lack of hands-on experience—it is prudent to conduct a pilot study. A pilot project is particularly advisable if the project is a large and costly one. The main purpose of a pilot study is to determine whether the propagules will grow under conditions found on the site. The study can be conducted in less than a year, but the test species should be allowed to grow for one full season before conclusions are drawn. Seasonality can have great effects on sea grasses due to changes in water quality and movement. Such a pilot project should be of sufficient size that it accurately reflects future operational difficulties. The size of the pilot study is limited only by the desired tests, the time available for such testing, and funding. A simple statistical design will permit quantitative evaluation of the study, where prediction of degree of success or failure can be made. The success of these plants can generally be evaluated by observation of survival. Test plots established should be evaluated on a regular basis to determine survival and growth and, if the planting fails, to assess the actual cause of failure.

5.33.6.6 Time of planting. Almost without exception, spring is the best time for planting sea grasses. Transplanting can be successful in other seasons, but with less overall survival.

5.34 Clam Flats, Oyster Beds, Mussel Beds, and Other Shellfish Habitats. Several examples of shellfish beds (oyster beds) have been constructed in Chesapeake Bay (Garbarino et al. 1994), in Puget Sound (clam beds), and in the Ohio and Tombigbee Rivers (freshwater mussels) (Landin, Dardeau, and Miller 1992). All of the projects constructed under planned and well-designed circumstances have been successful. The projects involving oysters and clams were constructed by raising bottom elevations with dredged material, then capping the material with rough material such as oyster cultch to which oysters and clams could attach. In the Tombigbee River, gravel riffle beds were constructed to flush beds for endangered mussels. In the Ohio River, rock and gravel were spread over dredged material to provide a hard flushed surface for colonization. While general guidance for constructing these projects is available from the USACE Engineer Research and Development Center (ERDC), it has not yet been carried out enough to be considered predictable or routine.

### 5.35 Artificial Reefs and Underwater Berms.

5.35.1 Artificial reefs. There are probably more freshwater, interior examples of artificial reefs in the United States than coastal examples, but not constructed of dredged material. The most suitable substances for artificial reefs are new-work dredging in which rock, rubble, and other coarse debris are released, then carried via barge to a suitable location, where the material is piled to allow natural colonization by fish and other aquatic organisms. Material is generally loaded onto barges in shallow rivers and bays, dropped over the sides with a clamshell bucket where a relatively unproductive bottom occurs, and mounded on dredged material (sands,

primarily) that has been placed to raise bottom elevations. Such reefs, whether freshwater or coastal, are very successful and very prolific for aquatic organisms. More importantly, they will endure for many decades.

5.35.2 Underwater berms. Several examples of underwater berms have already been discussed, and it has been noted that 21 such berms have been constructed in the United States. Guidance for construction is provided in Langan (1987) and other sources. However, generalities can be discussed here. Stable berms, which can utilize huge quantities of dredged material, must be built in deeper water in stable hydrologic/hydraulic locations on the bay/sea bottoms so that they will not move or dissipate. They can be constructed of fine-grained sediments in contrast to feeder berms, which must be constructed with beach-quality sand. Hopper dredges are the usual construction method of all berms, in which dredged material is loaded onto split-hull barges towed over the berm site and released. It is more difficult to use a hopper dredge/barge for feeder berms because they are generally in shallow water. Locations for both stable and feeder berms are critical and have a significant effect on their success. Stable berms should have as steep a slope as can be achieved to provide structure shadow and refuge for finfish and shellfish. Both types of berms should be monitored for both engineering and environmental results. All berms already constructed have been examined for engineering integrity, but only the Mobile and Virginia berms have also been evaluated for habitat purposes (Clarke 1994; Hands 1994).

## Section VIII

### Beaches and Beach Nourishment

#### 5.36 General.

5.36.1 Shore erosion is a major problem along many ocean beaches and the shoreline of the Great Lakes. One of the most desirable, cost-effective shore protection alternatives is beach nourishment (Figure 5-40), which is usually accomplished by borrowing sand from inshore or offshore locations and transporting it by truck, split-hull hopper dredge, or hydraulic pipeline to an eroding beach. These operations result in massive displacement of the substrate, changes in the topography or bathymetry of the borrow and replenishment areas, and destruction of nonmotile benthic communities. However, a well-planned beach nourishment operation can minimize these effects by taking advantage of the resiliency of the beach and nearshore environment and its associated biota and by avoiding sensitive resources (Pullen and Naqui 1983).

5.36.2 Houston (1996) conducted an economic valuation study of beach nourishment in the United States and found that for every one dollar spend on beach nourishment using Federal money, spent or cost-shared with local or State interests, the return on the investment just to the U.S. Treasury was a hundredfold from tourism taxes. The revenues realized by local and State governments and the tourism industry itself were in addition to that Federal expenditure and investment return.



Figure 5-40. A Beach Nourishment Operation Underway at Mayport, FL

5.37 Types of Beach Nourishment. Four major types of beach nourishment occur along U.S. shorelines: new borrow material not connected with maintenance dredging, maintenance dredging of an existing channel, dumping in the littoral zone to allow beach nourishment, and rehandling of stockpiled material.

5.37.1 Borrow dredging. This type of dredging entails removal specifically for beach nourishment. The major physical impact of dredging borrow material is the mechanical disturbance of the substrate and the subsequent redistribution of suspended sediments and turbidity. Suspension of sediments and turbidities is usually a short-term impact. Once dredging ceases, heavier sediments rapidly settle, and fine sediments are dissipated by waves and currents. Sea bottom borrow pits remain intact for long periods of time unless currents transport sediments into the pits and fill them. If the borrow pits are in an area of low wave energy and the surrounding bottom sediments contain high levels of organic materials, the pits are likely to slowly fill with the organic-laden sediments. Decomposition of the organic material in these pits may result in anaerobic conditions and generally poor water quality.

5.37.2 Maintenance and new-work dredging. The use of maintenance and new-work dredged material for beach restoration can serve two beneficial purposes: placement of the material and restoration of an eroding beach. If such material is selected, it should closely match the sediment composition of the eroding beach and be low in fine sediments, organic material, and pollutants. Sediments containing large quantities of fine materials result in high turbidities and may introduce trace metals and other contaminants into the water. High turbidities and sedimentation may inhibit reestablishment of beach animals that have a specific habitat requirement or may prevent recruitment to the beach by pelagic larvae, particularly if beach restoration

occurs during the peak spawning season in spring and early summer. The placement may interfere with the selection of a nesting beach by sea turtles if beach sediments are significantly changed, and the appearance of such sediments is aesthetically displeasing.

5.37.3 Dumping in the littoral zone. Placement of dredged material can be by deliberate placement on the sea bottom, where it will be carried by currents and waves to the beach. The dredged material will replenish the eroding beach in a natural manner as it is carried by wave energy. Material can be placed in the littoral zone by hydraulic pipeline or by split-hull hopper dredge.

5.37.4 Rehandling stockpiled material. Coarse-grained dredged material can be pumped into a holding area, where it is allowed to dewater. Then it can be moved by truck or heavy equipment onto the eroding beach. This technique is commonly applied in small restoration projects.

### 5.38 Environmental Considerations.

#### 5.38.1 Impacts on beach organisms.

5.38.1.1 Animals on high-energy beaches are subject to the effects of seasonal sediment erosion and accretion as well as major physical changes related to storms. In the Pacific Northwest, animals may be stressed to the 18 m (60 ft) contour. Beach animals are adapted to survival under these stressful conditions whereas those animals offshore are generally in a more stable environment and are less adapted to a high level of sediment movement. Burial of nonmotile benthic animals by replenishment material placed on the beach or material being transported offshore from the beach is usually lethal unless the animals are able to migrate through the sediment overburden and escape. Laboratory studies have shown that some benthic animals (especially bivalves) can migrate vertically through more than 0.3 m (1 ft) of deposited sediment. The ability of benthic animals to survive burial by dredged material depends not only on the depth of the sediment, but also on the length of time the animals are buried, the time of year, the sediment grain size, the quality of the sediment, and other specific requirements of the animals. Therefore, rate of survival varies from location to location.

5.38.1.2 Some “beach” animals, such as colonial seabirds and solitary-nesting plovers, are highly adapted to the dynamics of beaches, and use them for nesting, resting, and feeding. Bare-ground nesting species, such as least terns and black skimmers and some plovers, are frequently found nesting on dredged material beaches. They are much more likely to be successful nesting on undisturbed, or relatively undisturbed, beaches. On a 32 km (20 mi) dredged material beach between Gulfport and Biloxi, MS, several kilometers have been set aside and are protected for nesting by least terns. This beach protection is enforced by county ordinance and by road and beach patrol, and the beach is plowed to remove colonizing vegetation during the non-nesting season using county equipment. The result is a spectacular least tern colony of several thousand pairs, the largest colony in North America (Figure 5-41) (see Section VI, “Island Habitats”). Other species also take advantage of this protection and nest there as well.



Figure 5-41. Dredged Material Nesting Beach for Least Terns at Gulfport, MS

5.38.1.3 Beach nourishment creates new habitat that is uninhabited by benthic animals, except for those that may have survived being pumped to the beach with the dredged material or those that survived by vertical migration through deposited sediments. A beach nourishment operation is generally followed by rapid establishment of new benthic populations. Many of these are opportunistic species that develop large population densities, then decline as other species that are more adaptable to the new habitat are recruited. The time for the resident species to become established is referred to as the recovery time of the nourished area (the time required to approach a stable animal population level). Recovery time varies, depending upon type of recruitment of benthic animals. Those animals that have planktonic larvae or can migrate from nearby areas into the nourished area establish rapidly whereas those that spend their entire life cycle within the sediments may be slow in recovering. Once beach restoration ceases, recovery of benthic animals is generally rapid, and complete recovery usually occurs within one or two seasons.

5.38.1.4 The sediment type used for nourishment and the season of year the nourishment takes place are critical to the recovery rate. If the dredged material is different from the natural beach sediment or contains large quantities of fine material, there may be a major change in beach biota, and it may require a long period of time before local resident populations can be reestablished.

5.38.2 Impacts on offshore organisms. Potentially, the most serious impact of offshore dredging is the loss or damage to major commercial species of benthic shellfish, sea grass beds, corals, and sea turtles. Damage can be minimized by proper selection of borrow areas, by precisely positioning the dredge to avoid these sensitive resources, and by using dredging equipment that minimizes sedimentation and turbidity, such as a suction dredge.

#### 5.38.2.1 Benthos.

a. Repopulation of a dredged area by benthic animals depend on the magnitude of the disturbance, the new sediment interface, and the water quality in the borrow pit. Borrow pits will be recolonized by migration of animals from adjacent areas and by larval transport. Stability of the environment and bottom sediment type after dredging are major factors in determining the level and rate of species recolonization. It is extremely important to remember that if bottom sediments are significantly changed from the natural sediments, the reestablished populations may not be of the same magnitude or species composition as those prior to dredging.

b. Offshore borrow pits that accumulate organic material and acquire high concentrations of hydrogen sulfide and low concentrations of dissolved oxygen in the water are generally very poor quality aquatic habitats. They also usually take a long time to recolonize by benthic animals, or may never recolonize.

#### 5.38.2.2 Corals.

a. The ability of corals to recover from beach nourishment is related to the extent of reef damage. If a reef is heavily damaged by equipment being dragged across the reef, by being covered with sediments, or by all corals being killed, the reef can take a long time to recover, or it may never recover. It has been shown that corals may recover if the damage is not too extensive. Corals along the Florida Atlantic Coast damaged during beach nourishment apparently recovered by 7 years after the dredging operation.

b. Corals along Florida and Hawaii coasts are susceptible to direct physical damage by dredging and to sedimentation and reduced light unless dredging operations are carefully planned and executed. With proper planning and control, dredging impacts on corals can be minimized. One of the most significant impacts on corals results from dragging of anchors and cables, which collapse the reef and destroy benthic animals. Erosion and scour at the base of the corals in the dredged area also may damage corals. This can result in the corals slumping or tilting or in forming overhangs that tend to break off. Reef coral recovery is very slow.

#### 5.38.2.3 Fish and motile invertebrates.

a. The mobility of fish and some invertebrates renders them less vulnerable to the adverse effects of beach nourishment than the nonmotile benthic communities. When disturbed by beach nourishment, motile animals generally leave the area. Those animals that do not leave or are susceptible to suspended sediments in the water can be killed by coating of their gills, leading to anoxia; or if they spawn in the area, the sediments may cover or delay hatching time of their eggs. Feeding habits also may vary according to length of exposure to suspended sediments. Filter-feeding fish are more vulnerable to siltation than bottom feeders.

b. Destruction of habitat rather than suspended sediment seems to be a greater potential problem to fish. Those fish either closely associated with the beach for some part of their life cycle for spawning (for example, California grunion) and some burrowing and reef-dwelling species with limited mobility (for example, the dusky jawfish on the Florida Atlantic Coast) are

more likely to be adversely affected. Beach nourishment operations at Imperial Beach, CA, did not prevent subsequent spawning of the grunion; however, on the Florida Atlantic Coast they may have displaced the dusky jawfish.

c. Loss of benthic animals due to sediment burial may indirectly affect motile animals that prey on them. This was suspected to have occurred following a nourishment project on the North Carolina coast. Nourishment occurring during the peak season of beach animal recruitment delayed population reestablishment for several months. During this period, fish and shellfish that usually feed in the surf zone were not observed. Nourishment may also have had short-term benefits to some fish by suspending additional food materials, and the associated turbidities may have provided protection from predators to some motile animals. Studies have shown that moderate to complete recovery of motile animals usually occurs within less than a year unless a required habitat or food source is permanently lost. Fish have been observed moving into an area within the first day after a disturbance.

d. Mobile animals are least affected by borrowing operations because of their ability to avoid a disturbed area. Studies have shown that fish leave an area of active dredging and return when dredging ceases. Whether fish continue to use a borrow pit as habitat depends on water quality in the pit. If the pit accumulates anaerobic sediment that results in poor water quality, fish will avoid the pit. However, fish may be attracted to a dredged area as a result of suspended food and as a haven from the cold surface water during the winter. The sediment plume from the dredge may also provide protection to some motile animals. Total recovery at a dredged site, therefore, is variable and ranges from immediate for some species to a year or more for others, depending on the nature of the habitat modification.

#### 5.38.2.4 Sea turtles.

a. The sea turtle is one of the animals most vulnerable to the effects of beach nourishment on the South Atlantic and Gulf Coasts (Figure 5-42). Turtle nesting on the beaches and replenishment operations occasionally conflict in these areas. There is concern that turtle nesting and hatching success may be adversely affected by beach nourishment. Guidelines for placing sand on a known turtle nesting beach are not complicated. Dredged material should be pumped onto the beach in a natural beach profile and contour at least 6 months prior to turtle haul-out so that the material has had time to settle, sort, and begin to function like a natural beach prior to egg laying. Winter months (December-March) are the months outside sea turtle nesting windows.

b. Sand particle size and sand compaction have been found to influence nest site selection by some sea turtles. Aborted nesting attempts (false crawls) have occurred on rebuilt beaches in Florida. The precise effects of beach nourishment on nesting sea turtles have not been documented because of insufficient studies. The present limited data indicate caution should be taken in rebuilding beaches that are known to be major turtle nesting sites. It is best to avoid turtle nesting beaches from April through November, the period encompassing all of the sea turtle nesting and incubation season. Such operations must be closely coordinated with the U.S. Fish and Wildlife Service (FWS), the National Marine Fisheries Service (NMFS), and State agencies.

31 Jul 15



Figure 5-42. A Sea Turtle Hatchling Moving Toward Open Water on a Florida Dredged-Material Beach

c. Hibernating or aestivating sea turtles have been captured and killed by trawls and dredges. Turtles that are not hibernating or aestivating should be able to avoid a dredge and move back into an area when dredging ceases. If hibernating sea turtles are located, dredging should cease until the operation can be coordinated with the FWS. A new series of studies has found ways to exclude hibernating turtles from being sucked into dredges, and all dredges working in channels where sea turtle hibernation is likely must be equipped with these excluders.

5.38.2.5 Sea grass beds. Caution should be taken to avoid these highly productive areas because sea grasses recover very slowly, if ever. Both the actual dredging operation and the turbidity caused by adjacent dredging destroy sea grasses. To date, sea grass transplantation has not been refined to a point where a high-percentage survival of transplants and economic feasibility justify efforts to restore large areas of destroyed sea grasses. Dredging cautions for corals should also apply for sea grasses. See Section VII, "Aquatic Habitats," for guidelines on restoration of sea grass beds.

5.38.3 Timing. Timing of the nourishment operation may also be a critical factor in reestablishment of benthic animals. If nourishment occurs during spring and early summer, recruitment of planktonic larvae may be inhibited. High turbidities and unstable substrate are known to preclude larval settlement, thus delaying recovery time of benthic animals. The best time ecologically for beach nourishment and borrowing is during the period of lowest biological activity. This is usually during the winter when there would be minimal effect on the adult and developmental stages of most nearshore and beach animals. At this time, adults have usually migrated out of the area and are less concentrated in the shallow beach zone, and the nesting and



spawning season of beach animals has passed. Nevertheless, it is still necessary to ensure that no sensitive nonmotile animals are in the area.

5.38.4 Dredged material substrates. Sediments to be used as material should match the natural beach sediments and be low in pollutants. This recommendation is particularly important when maintenance dredged material is used for beach nourishment. Minimum damage to beach animals occurs when clean sand is placed on a sandy substrate whereas damage to the benthic animals is great if fine sediments high in organic material are used. Changes in the sand particle size on ocean beaches, should they occur, may also influence site selection and nesting of the threatened and endangered sea turtles.

#### 5.38.5 Equipment in sensitive areas.

5.38.5.1 If it can be avoided, the cutterhead on a suction dredge should not be used in the vicinity of live coral reefs or other light-sensitive resources unless barriers are established to separate the dredging site from them. The suction dredge without a cutterhead is a better choice because siltation is minimized, and there is less potential for physical damage to the reef. The dredge should be positioned within the designated borrow area and should not cross a live coral reef, commercial clam bed, or other valuable resources. Cables, anchors, and discharge pipes of a dredge should be positioned in sand or another nonsensitive habitat. Local directions in tidal flow and current should be determined prior to dredging and the operation adjusted to prevent sediments from crossing live coral reefs or other sensitive resources.

5.38.5.2 Consideration should be given to shallow dredging over a large area in a low wave energy environment rather than deep dredging, which may create a stagnant borrow pit that will require a long time to recover or may never recover. Although ecological damage from dredging the shallow pit is initially greater, recovery should be faster in the shallow dredged area.

5.38.6 Monitoring. Biotic surveys should be made at beach restoration and borrow sites. As an absolute minimum, a preproject baseline survey should be made to identify and locate natural resources (for example, corals, commercial clam beds, sea turtle nesting beaches, fish spawning areas, and sea grass beds) to aid the planner in avoiding potential damage to these resources.

## Section IX

### Parks and Recreation

#### 5.39 General.

5.39.1 Potential recreational uses of dredged material placement sites are practically unlimited. They range from projects as simple as fill for a recreation access road to projects as large as Belle Island in the Detroit River on the United States-Canada border and the Lake Vancouver Park, WA, to projects as complex as the 1,800 ha Mission Bay development in San Diego, CA, supporting both public and private commercial and noncommercial recreation facilities. There are several hundred known examples of recreational beneficial uses of dredged material, a number of which are listed in Appendix D, "Plant Materials for Beneficial Use Sites." Many sites are multipurpose—while they include recreation facilities and activities, they also

include education (nature trails, visitors centers, museums), fitness (hiking biking, jogging), natural resources, commercial, and other types of beneficial uses as well.

5.39.2 Of all types of beneficial uses, recreation on dredged material containment sites is one of the most prevalent land uses in actual acres. It is not surprising to find many examples of such use since there is such a demand for recreational sites in urban areas, where much dredging occurs. However, this requires sound, careful planning to accomplish; financial investments vary from project to project and can be quite expensive on large complex sites. The nature of recreation sites with requirements of a lot of open space and lightweight structures is especially suited to the weaker foundation conditions associated with fine-grained dredged material. Recreational land also is generally for public use, and high demand for public water-oriented recreation encourages the development of recreational land use projects on dredged material. Finally, legislation relating to wetlands, coastal zone management, and flood control is biased in favor of this type of use. The recreational land use of dredged material containment sites is one of the more promising and implementable beneficial uses of dredged material, but it is heavily dependent on financial backing at the local level.

5.39.3 Many factors influence the potential use of dredged material placement sites for recreational purposes. Important ones that must be considered include the local or regional demand and need for recreational facilities, the interest and capability of local cost-sharing sponsors to participate in development and operation, and available access. Local and regional planners, State Comprehensive Outdoor Recreation Plans, and public participation programs are all sources of information about public demands and needs. Local and regional planners are also good sources of information on potential project sponsors. As Americans devote more and more time to natural resource exploration and leisure activities, the demands on recreation and park facilities are at an all-time high. Visitors to dredged material sites that have been developed beneficially for recreation number in the hundreds of thousands annually (Skjei 1976).

5.39.4 The recreational facilities that the USACE develops at flood control and hydropower dams/reservoirs are built near bodies of water and, as a result, a number of them are also located completely or partly on dredged material.

5.40 Case Studies. Many worthy case studies throughout the United States and Canada could be highlighted in this manual. Dredged material foundation recreational and park facilities exist along nearly every large waterway and water-fronted city in America.

5.40.1 Lake Vancouver. A large, complex lake restoration dredging project constructed by the Port of Vancouver, WA, from 1985-1987, used the dredged material in numerous beneficial ways, including channel access improvements and the construction of beaches and picnic facilities as well as islands in the lake that attract fishermen and boaters. Some of this rich dredged material was also used to enhance sandy agricultural land in the vicinity. This project was so state-of-the-art in the Pacific Northwest when plans were announced that it took 10 years for the Port to obtain all of the necessary state and federal permits for restoration construction due to the lack of precedent in the region. However, it is a stellar example of lake restoration techniques and practices for the United States and can be used as a model for hundreds of lakes and reservoirs in need of restoration due to trapped sediments (Landin 1997a).

5.40.2 Belle Island. A large natural island in the Detroit River, in Michigan on the United States-Canada border, has been enlarged and enhanced during numerous dredging cycles using material from the river. In the 1990s, recreational facilities constructed on dredged material included beaches, a museum, fitness paths/walks, softball and other sports fields, picnic facilities, parking lots, and other open space. There are still ample opportunities for continued expansion of Belle Island using maintenance dredged material.

5.40.3 East Potomac Park. A noncommercial recreational development at East Potomac Park in southwest Washington, DC, is located astride the confluence of the Anacostia and Potomac Rivers. Placement operations completed in 1912 created 133 ha from fine-grained clays and organic materials dredged from the Potomac main channel. By 1925 the park had reached full recreational development, and since 1939 ownership and operation of the facility have been in the hands of the National Park Service. The site currently offers four nine-hole golf courses, a snack bar, a driving range, and a clubhouse. Other recreational facilities include a swimming pool, indoor and outdoor tennis courts, eight baseball fields, and fields for field hockey, football, and polo. Buildings on the site include the National Park Service offices, a maintenance building, a comfort station, and several other minor structures. Use of the park open space for recreation has increased to the extent that the conversion of a portion of golf course land to open space is being considered. The park serves a regional need for recreation of residents of the District of Columbia, Arlington County, and the City of Alexandria, VA, as well as for area commuters. In 1975, the North Atlantic Division placed the value of the park at \$94 million. In 1999, the park served tens of thousands of citizens and visitors to Washington, DC.

5.40.4 Patriots Point. The Patriots Point Project, a 182 ha commercially oriented recreational site immediately across the Cooper River, 1.6 km (1 mi) east of Charleston, SC, was built on an old placement site. The site, formerly known as Hog Island, was used for placement of maintenance and new-channel dredged material, primarily mixed sandy silt and clay, from 1956 to 1970; dikes were constructed of heavy clay. In the early 1970's, a quasi-state agency, designated the Patriots Point Development Authority, was established to plan and develop a recreational complex. The focal point of the development is a Naval and Maritime Museum with the aircraft carrier Yorktown, moored at the site in early 1976, as the principal attraction. The Authority's master plan includes an 18-hole golf course, a 150-room motor inn with convention facilities, a 375-slip marina, a 300-space recreational vehicle park. Long-range construction includes an oceanarium, aquatic theater, amphitheater, restaurant, man-made lakes, and permanent mooring for at least three more classes of decommissioned naval ships as the vessels become available. A dike-top tour route around the site was constructed. The project attracts some 1.5 million visitors annually. Structures at the site are supported on pilings due to the compressible nature of the fine-grained dredged sediments and underlying organic material. An overburden of sand will be added as needed to provide suitable drainage and foundation conditions for light structures and parking areas. Topsoil, including some dredged material, was placed in portions of the site to encourage vegetative growth, particularly in designated buffer zones. Figure 5-43 depicts the master plan for Patriots Point. The Patriots Point Park is an ongoing project that will continue to provide recreation in the Charleston area to citizens and visitors.

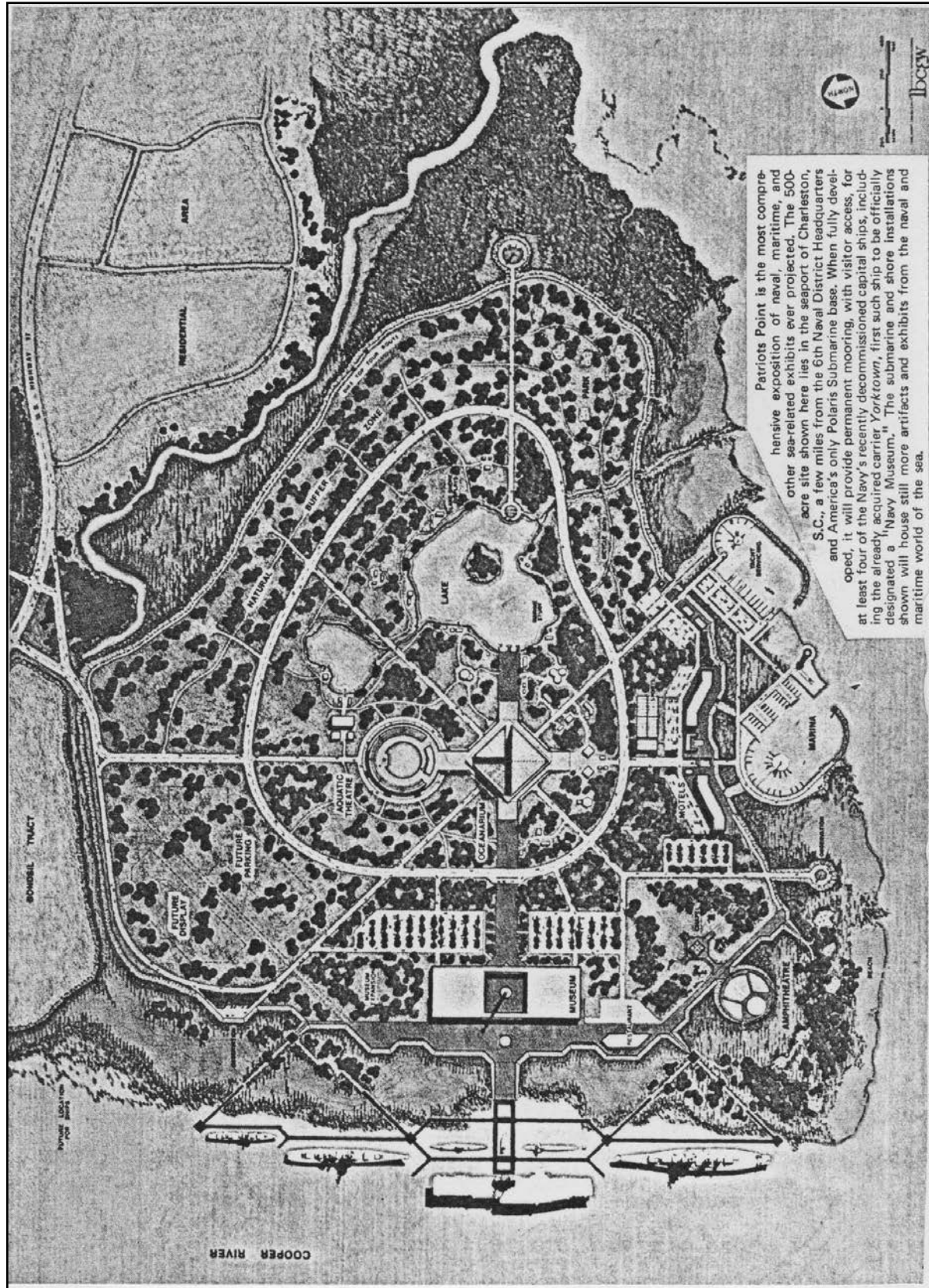

Figure 5-43. Master Plan of Patriots Point Naval and Maritime Museum, Charleston, SC (from Conrad and Pack 1978); This Site Continued to Follow its Master Plan in 2000

5.40.5 Kalawa Recreational Area. A large marina, fishing pier, and water sports complex was built in the 1970s on sandy dredged material in the Columbia River at Kalawa, WA (Figure 5-44). The area was armored with riprap to prevent current erosion. It also contains park areas, a heliport, a recreational center, and baseball fields.

5.40.6 Central U.S. and Mississippi Valley. Numerous recreation sites—such as riverside picnic areas, water parks, marinas, and other river-related sites—have been built on dredged material, both by the USACE and by private sponsors, along the Mississippi, Missouri, Illinois, Tennessee, Tombigbee, and Ohio Rivers and their tributaries. In the U.S. and Canadian Great Lakes, parks, marinas, fishing piers, and other recreation facilities have been built on dredged material in Lake Erie, Lake St. Clair, Duluth Harbor, and a number of other urban areas.

5.40.7 Others. More than 150 selected examples of recreational use of dredged material are listed in Appendix D, “Plant Materials for Beneficial Use Sites.”

#### 5.41 Recreation Activities and Facilities.

5.41.1 Certain types of private recreation facilities, while they are on dredged material placement sites, are normally provided by private enterprise. Although the USACE does not participate in the provision of these types of facilities, they should be regarded as potential beneficial uses since they occur on placement sites. These sites often provide cost-feasible and socially acceptable placement alternatives. Placement sites in coastal and riverine areas have highly diverse recreation potential, especially for water-oriented activities. These sites are especially attractive for shoreline recreation development, such as swimming beaches, boat launching ramps, and fishing piers. When areas are of sufficient size, campgrounds, marinas, outdoor sport facilities, and hiking and nature trail systems may be constructed. Recreation development potential of these areas is quite high when authority, funds, and land area are all of sufficient amounts, and the public interest is best served by such development. The types of activities and facilities that can be provided on dredged material sites are included in Table 5-8. Recreation planning and design criteria for specific recreation facilities are provided in EM 1110-2-410. While high site recreational use is generally dependent on facilities development, undeveloped placement lands also attract a segment of the public for activities appropriate for those areas, such as nature study, primitive camping, hiking, hunting, and beachcombing. Provision for access to these areas is one of the minimal requirements. These undeveloped sites are also used as trails for off-road vehicular recreation.

5.41.2 Dredged material placement islands are also used extensively for recreational purposes. They provide a base for such water-based activities as hunting, fishing, boating, water-skiing, swimming, and camping. In many river and estuarine systems, dredged-material islands and beaches are the only available sandy beaches, and there is often site use conflict between wildlife, especially ground-nesting colonial birds and beach-nesting sea and freshwater turtles, and humans. The recreation experience and enjoyment of the users can be affected by the development and design of the placement sites and by the timing of placement operations. Variations in size, proximity, and level of development of camping sites can provide a diversity of recreation experiences.

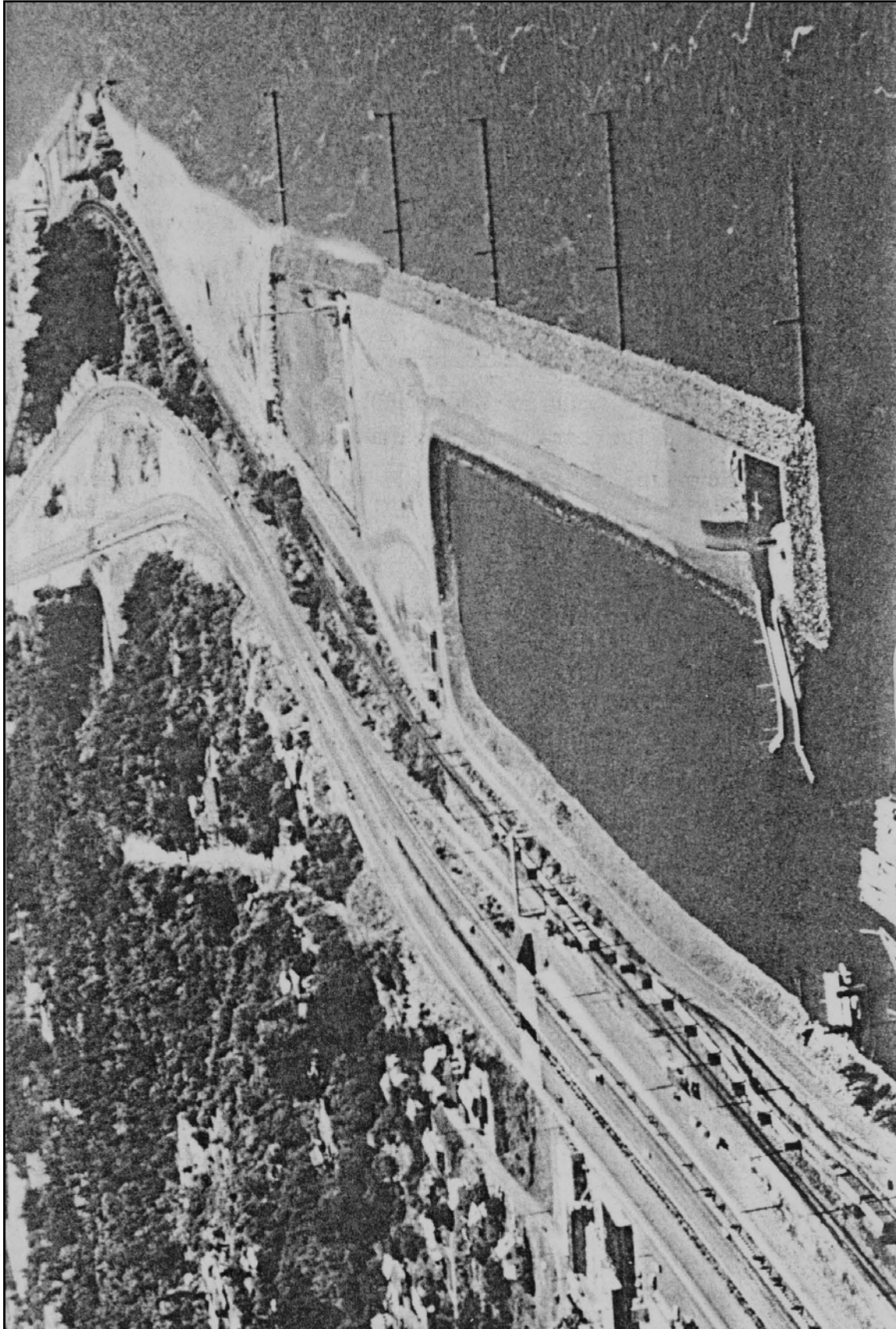

Figure 5-44. This Riverside Recreational Area at Kalawa, WA, was Built on Material Dredged from the Columbia River more than 25 Years ago and is still in Active Use



Table 5-8. Types of Recreational Activities and Facilities Found on Dredged Material Placement Sites

Activities	Required Facilities
Beachcombing	Beach
Bicycling	Trails or roads
Bird watching	Undeveloped natural areas
Boat launching	Ramps, parking area, marina
Camping	Campground
Dining	Restaurants and snack shops
Fishing	Water access
Hiking	Trails
Hunting	Undeveloped natural areas
Motorcross and dirt biking	Trails
Nature study	Undeveloped natural areas
Outdoor games	Athletic fields and playgrounds
Picnicking	Tables, trash receptacles
Sunbathing	Beach
Swimming	Beach
Viewing	Scenic overlook or observation tower

5.41.3 Development of facilities and vegetation on these islands should preserve the more primitive conditions of naturally occurring point or island bars. A study of recreation users on the Upper Mississippi River noted preferences for undeveloped islands composed of mostly open sand with some trees and grass; islands with riverine vegetation were not favored. Extensive vegetation on placement islands is therefore not required nor desired for recreational use. The use of a given dredged material island or sandbar was influenced by the presence of sandy beach areas, adequate water depth for boats, and uncrowded conditions that gave users relative isolation from other campers. Similar studies and observations have been made on coastal dredged material islands, and users consistently preferred the undeveloped islands. Since these are the same islands used by nesting colonies of sea and wading birds, careful management is very necessary.

5.41.4 Proper location of dredged material islands and access points can also reduce boating congestion in locks and navigation channels. Many boaters in the Upper Mississippi River survey noted that they used the locks only to reach their favorite placement sites. Development of more and better spaced multiple launching points and/or the location of specifically designed placement sites near population centers could eliminate some of the recreation blockages and the traffic congestion in navigation channels.

5.41.5 The recreation potential of both shoreline and island placement areas can be enhanced by management of fish and wildlife habitat. Fish and wildlife habitat development is an authorized purpose goal of navigation projects involving dredging, and it is strongly encouraged by the USACE. Wildlife enhancement and mitigation may also be required to offset habitat losses due to project construction. In such cases, lands are generally purchased or long-term easements obtained, and detailed habitat management plans are developed and implemented. However, in a number of areas where dredging occurs, placement sites are limited, and even a well-developed long-range management plan is usually lacking for enough placement sites. In these instances, it may be more practical to manage for nongame species and nonconsumptive recreational use rather than the more traditional game management for sport hunting. A variety of songbirds and other small animals is appreciated by the public, and with proper habitat management (such as nest boxes, food and cover plantings, and bird watching observation towers), these species can be encouraged around picnic, camping, and other recreation areas.

5.41.6 When fishing is a recreational goal at a placement site, some basic management techniques to maintain high populations and harvests of game fishes may be required by developing and maintaining ponded areas in placement sites. Spawning beds and water level manipulation to enhance reproduction, reefs, and piers to attract and concentrate fish, and a sound plan for dredged material placement contribute to a healthy sports fishery in a given area. This includes management of pest species such as an overabundance of native carp and bait fish escaped from bait pails, exotic carp, and zebra mussels.

#### 5.42 Recreation Carrying Capacity.

5.42.1 Proper design of recreation developments on dredged material placement sites can ensure that recreation use does not exceed the recreation carrying capacity of the resource. Carrying capacity is the maximum potential level of use that avoids social overcrowding and resource overuse. A number of methods are available to estimate recreation carrying capacity of projects (Urban Research and Development Corporation 1980). Proper project design of structures, facilities, and access points decreases the likelihood of overuse or underuse. Overuse of recreational resources results in overcrowding of recreation users and degradation of the dredged material resource. Since most parks and recreational facilities constructed on dredged material are already heavily used, utilization of more dredged material and construction of more riverbank and shoreline parks are greatly needed to provide citizen recreational opportunities.

5.42.2 Sandbars, beaches, and other placement sites can be strategically located to further disperse recreation use to areas able to support the use. Barriers and screens such as ditches, fences, and berms can be placed adjacent to environmentally sensitive areas and hazardous locations at placement sites such as those where incremental dredging is still occurring and where recreation use is not desired. On such sites still in active use, serious consideration must be given to liability from accidental or purposeful human intrusion onto the active placement portion of the site. The density concentrations of boating, boat fishing, and waterskiing can be affected in part by the number, location, and distribution of boat launching, docking, and servicing facilities built throughout an area. Providing multiple launching and docking facilities at placement sites tends to reduce density concentrations and distribute recreation use more evenly.



5.42.3 Maintaining fenced-off sensitive areas—such as ongoing dredging operations, nesting bird colonies, and sea turtle nesting beaches—is a continuing management problem on dredged material sites because both ordinary citizens and vandals cut, break, and otherwise compromise fences to get at what they perceive to be better recreational spots inside the fences. This is especially a problem along beaches where law enforcement and supervision are stretched thinly. It is impossible to supervise fenced-off areas on isolated islands and primitive rural riverbank sites, and signs are usually the only means available to aid in education. Such potential invasions and vandalisms should be taken seriously when planning, locating, and designing dredged material recreational areas, and sites be placed or designed where these problems are taken into account from the outset of the project. Once a project is in place, it is often too late to go back and design in features that allow for sensitive area designation without causing other problems with the overall design and with public perception and recreational use of the project site.

## Section X

### Agriculture, Horticulture, Forestry, and Aquaculture

5.43 General. Over the past 100 years, considerable and innovative uses of dredged material placement sites have been made by the agriculture, forestry, horticulture, and aquaculture industries. Some placement sites, especially in river systems, have provided livestock pastures. These pastures have not been developed in any way except by allowing natural grass colonization or by planting pasture grasses on them. Other uses involve actively incorporating dredged material into marginal soils (Gupta et al. 1978). An attractive alternative for disposing of dredged sediments is to use these rich materials to amend marginal soils for agriculture, forestry, and horticulture purposes. Marginal soils historically were not intensively farmed because of inherent limitations such as poor drainage, unsuitable grain size, and poor physical and chemical conditions, but in the past few decades they were put into intensive row-crop cultivation due to increases in world farm prices. Now these lands are being reclaimed as the forests, wetlands, and grasslands they once were through the U.S. Department of Agriculture Natural Resources Conservation Service (USDA NRCS) private-landowner-cooperative Wetlands Reserve Program because the lands were not suitable for intensive cultivation. Millions of hectares of these marginal soils are located near waterways; over 500,000 ha have already been converted back to natural habitats through the Wetlands Reserve Program and other incentive programs.

5.44 Agriculture. Walsh and Malkasian (1978) and Landin (1997b) note extensive interest in the agricultural use of dredged material, especially by cost-sharing sponsors looking for partners in placement sites. For example, about 200 ha of the Old Daniel Island Placement Site in South Carolina have been successfully truck farmed for the past 22 years, and other parts of the site are planted in soybeans, an agronomic crop. The Tulsa District has approximately 1,200 ha of dredged material containment sites leased for use as grazing land, and grazing is extensive on dredged material deposits along the lower Columbia River. When dredged material is free of nuisance weeds and has the proper balance of nutrients, it is very similar to productive agricultural soils and can be beneficial for increasing crop production when incorporated or mixed. By the addition of dredged material, the physical and chemical characteristics of a marginal soil can be altered to such an extent that water and nutrients become more available for crop growth. In some cases, raising the elevation of the soil surface with a cover of dredged material may

31 Jul 15

improve surface drainage and reduce flooding and therefore lengthen the growing season, such as for soils in floodplains. Adding sand dredged material to heavy clay (for example, Lake Vancouver, WA) and adding silt to pure sand (for example, Nott Island, CT) to improve soil productivity are very feasible options. Dredged material characteristics that influence plant growth and guidance for dredged material incorporation and cover use are discussed in this section.

5.44.1 Planning considerations. Chemical and physical analyses of the dredged material, site locations, weed infestation potential, and possible salinity problems must be considered before deciding upon the suitability of a specific dredged material as a medium for agricultural purposes. Figure 5-45 demonstrates priority listing of these factors to be used when considering the feasibility of an agricultural use for dredged material at the containment site (Spaine, Llopis, and Perrier 1978).

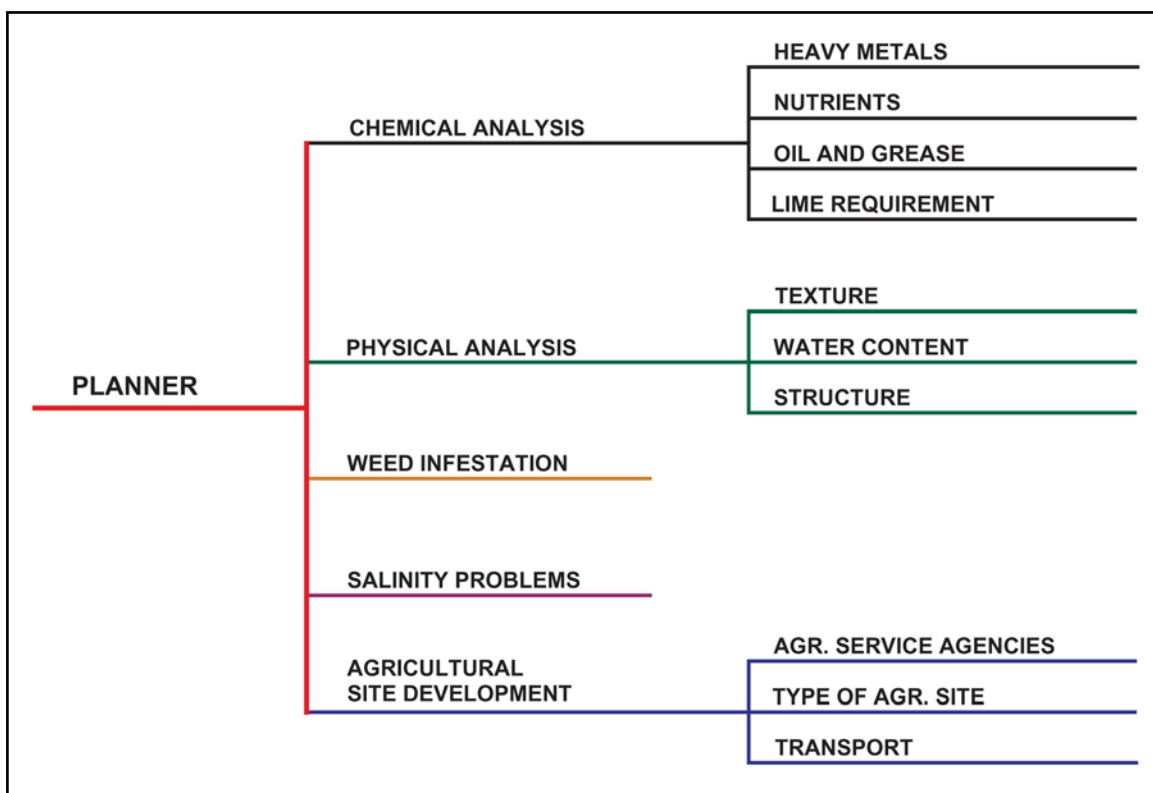

Figure 5-45. Decisional Factors to be Considered at the Dredged Material Containment area Before Applying Dredged Material for Agricultural Purposes

5.44.1.1 Chemical analyses. Since dredging operations may take place in waterways containing industrial wastes and sediment runoff from agricultural areas, dredged material can contain heavy metals, oil and grease, high nutrient concentrations from fertilizer runoff, and other enrichment or contaminants.

a. Heavy metals. Heavy metal uptake by plants depends on a number of factors, primarily the form and concentration of metals in the rooting media, and the type and variety of plant.

Research has shown that the heavy metal uptake by plants is normally much less than the heavy metal content of the rooting media (Gupta et al. 1978; Lee, Engler and Mahloch 1976). Table 5-9 shows the range in the concentration of heavy metal uptake by agronomic and common vegetable food crops grown under normal conditions and the suggested plant tolerance levels (Gupta et al. 1978; Lee, Engler and Mahloch 1976). The question as to whether to produce food or nonfood crops depends on the chemical contaminants present in the dredged material. Agricultural service agencies and extension offices can assist with guidelines and answers to specific questions. Research has shown that relationships exist between the extractable heavy metals in the soil and the heavy metal uptake by certain plants (Lee et al. 1978). These data are important to dredged material applications upon existing soils if a food crop is to be grown, but they are less important when nonfood crops are to be produced. Examples of nonfood crops are Christmas trees, pulpwood, commercial timber, or wooded wetlands grown on dredged material containing concentrations of heavy metals too high for human, domestic livestock, or wildlife consumption (A.D. Little, Inc., 1975; Landin 1997b). Another example is the uptake of minimal amounts of heavy metals in the heads of grain plants, making them a good food crop selection even if larger amounts of heavy metals are present; however, the heavy metals may concentrate in the leaves, making these grain crops less desirable when harvested as a forage. A unique example of the utilization of what had been perceived by regulators as being “too contaminated” for wetland mitigation purposes are hundreds of hectares inside abandoned containment sites of sandy dredged material being farmed by local landowners in New Jersey in corn, soybeans, hay crops, and millet (Landin 1997b). Soil analyses conducted by the company proposing the forested wetland mitigation use in 1995 of one of these sites in New Jersey indicate that the dredged material has never been or is no longer contaminated (no speculation as to which scenario applied).

Table 5-9. Average Range of Heavy Metal Uptake by Plants for Selected Food Crops<sup>1</sup> and Suggested Plant Tolerance Levels (from Gupta et al. 1978)

Element	Average Range, ppm	Suggested Tolerance Level, ppm
Cadmium	0.05-0.20	4
Copper	3-40	150
Iron	20-300	850
Manganese	15-150	325
Nickel	0.01-1.0	4
Lead	0.1-5.0	10
Zinc	15-150	350
Boron	7-75	200
Chromium	0.1-0.5	2

<sup>1</sup> Corn, soybeans, tomatoes, beets, lettuce, peas, potatoes, melons, squash, alfalfa, clover, wheat, oat, barley, and pasture grasses.

b. Nutrients. Nutrient analyses of dredged material should provide data to determine nutrient availability and to establish recommended fertilizer applications for vegetative production. The nutrient constituents of dredged material that require greatest attention are nitrogen, phosphorus, potassium, metallic metals, and organic compounds. Although medium- and fine-

grained dredged material is normally high in nutrients available for plant uptake, the levels of these nutrients are usually not high enough to limit plant growth. However, nitrogen, which is usually in the ammonium form, does undergo nitrification rapidly in an aerobic soil. Nitrate is the readily available form of nitrogen for plant uptake or loss by surface runoff and leaching into groundwater. Specific recommendations on rates of fertilizers can be obtained from the State soil testing service or local agricultural extension agent after soil tests have been conducted. A considerable portion of dredged material, especially in the Upper Mississippi River and some coastal areas, is sterile, clean sand. In these cases, the dredged material sites may never be suitable for agriculture, and will need major nutrient and soil amendment incorporation.

c. Oil and grease. Research has shown that the oil and grease content of some dredged material is considerably higher than that of soil. Depressed agricultural yields attributable to high oil and grease content have never been studied. Possible effects of high oil and grease content on soil properties or plant growth are an apparent slower wetting of the soil materials, a smothering effect on plant parts, and a tendency to restrict water uptake by the plants. Dredged material known to contain these contaminants should be grown only in longer-maturation, nonfood crops such as commercial timber or pulpwood.

d. Lime requirements. Lime requirements for dredged material vary, but if the pH of the material is below 6.5, it should be amended with ground agricultural limestone immediately after being applied to marginal soil for agricultural production and disked into the dredged material top dressing and the underlying soils. Large amounts of sulfur in the dredged material require heavy initial applications of lime to neutralize the acidity as well as succeeding applications to maintain neutral conditions. A soil pH below 4.0 indicates the presence of free acids resulting from the accumulation of sulfate and nitrate ions; a pH below 5.5 suggests the presence of toxic quantities of exchangeable aluminum, iron, and manganese; and a pH from 7.8 to 8.2 may indicate an accumulation of the bicarbonate ion, and the uptake of elements will be detrimental to plant growth. Gupta et al. (1978) provide specific recommendations on rates of both fertilizer and lime to apply at various soil (dredged material) deficiency levels. A rule of thumb for lime requirements of high-sulfur dredged material is to double the usual lime requirement and to make additional applications of lime every 2-3-years until the material stabilizes at a more sustainable pH for plant growth. One upland nesting meadow DMRP site at Nott Island, CT, was limed with generous amounts of lime and disked into the dredged material substrate, but it proved over time to be insufficient to maintain the mixture of planted legumes and grasses at the site. The legumes died out due to continued low pH and no additional applications of lime and fertilizers (Landin, Webb, and Knutson 1989). One of the objectives of the 25-year, long-term dredged material habitat development monitoring study that included Nott Island was to determine what natural successional changes occurred on the 11 study sites over time with no additional management and physical maintenance.

5.44.1.2 Physical analyses. The physical characteristics of dredged material can assist the USACE in making critical judgments of the best use of dredged material to ensure against adverse impacts on agricultural lands. The texture and water content are essential tests to aid in characterization of dredged material deposits within a containment site.

a. Texture. Textural classification helps to determine not only the nutrient-supplying ability of soil materials, but also the supply and exchange of water and air that are so important to plant life. Therefore, an important criterion is to adjust the texture of the final mixture of dredged material and marginal soil to approximate a loam soil (USDA classification). Using the Unified Soil Classification System (USCS), a dredged material of loam texture contains silts and clays whose liquid limit is less than 50. Mixing a fine-textured dredged material (silt and clay) with a coarse-textured marginal soil (sand) to the proportions of a loam would improve its physical and chemical characteristics for crop production. Sandy, coarse-grained dredged material is generally low in organic matter content, available nutrients, and heavy metal concentrations. Dredged material of this type may have potential as an amendment to heavy, poorly drained clay soils such as those found in the Lower Mississippi Valley floodplain, improving structure and permeability. For beneficial surface applications without incorporation with existing soils, it would be preferable to apply dredged material of loam textures only. Sandy loams are generally preferred for vegetable root crops such as carrots, beets, potatoes, and peanuts whereas loam to silt-loam soils are preferred for row crops, orchards, and small grains. Dry, sandy dredged material deposits along the Columbia River and similar conditions are being successfully used for livestock feed lots because drainage is superb on such sites, thus cutting down on disease incidence in the feed lots (Landin 1997b).

b. Water content. It is desirable to have the water content of dredged material being placed on agricultural lands within the plastic limit range. This presents fewer problems in handling, placing, and mixing. If dredged material is to be placed in slurry form, the lift thickness should be limited to 45 ha. This thickness of dredged material will usually dry within a 6-month period, depending upon dredged material texture, to the point where soil mixing and farming operations can begin.

5.44.1.3 Weeds. Weed infestation is generally a serious problem in many dewatered, inactive, fine-grained dredged material containment areas. Prior to the transport of dewatered dredged material to an agricultural site, an extensive weed control effort may have to be initiated to avoid serious weed problems to the agricultural producer. For example, an application of herbicide or removal of the top 15 cm (6 in.) vegetation layer of the containment area with a bulldozer before the transport of dredged material to the agricultural site would temporarily control the weed problem although weedy seed banks may still be present in the dredged material. Transport of such material, unless it was only to the advantage of the USACE to do so, should be at the expense of the agricultural producer. If the material has been very moist and the site is growing in common reed (*Phragmites*), moving the material to a drier agricultural field should eliminate the reed, but it is such a persistent species that herbicides may also be needed. However, some enterprising farmers in New Jersey who own old dredged material containment areas now cut and bale the common reed as hay for their cattle (Landin 1997b) (Figure 5-46).



Figure 5-46. Hay Bales of Common Reed, Used for Cattle Feed, in an Older Dredged Material Placement Site in New Jersey, 1996

5.44.1.4 Salinity. If the dredged material is from a coastal or tidal region, special attention must be given to salinity because crops will not grow on highly saline soils, and few agronomic crops will grow in brackish soils. Sand dredged material leaches salts readily and can be used in 1-2 years. The electrical conductivity of a soil-water extract gives an indication of the total concentration of soluble salts in the soil. The term “soluble salts” refers to the inorganic soil constituents that are soluble in water. Excess soluble salts not only limit the availability of water to plants but also restrict growth. Salt-tolerant plant species are available, and research on salt-tolerant agriculture crops has been underway for more than 20 years. The NRCS Golden Meadows Plant Materials Center in Louisiana has developed very promising salt-tolerant cultivars, a number of which have been commercially released and are being planted by American farmers. Techniques for treating dredged material with high salinity problems are available and should be completed before the material is transported to an agricultural site if the material is fine-grained; this is not necessary for sand dredged material.

5.44.1.5 Agricultural site selection. The distance and mode of transportation used for the movement of dredged material determines the major costs of its application to agricultural lands. Thus, the agricultural site selected should be in reasonable proximity to the dredged material placement site and adaptable to the long-range placement needs of the USACE.

a. Agricultural service agencies. In most areas of the country, a variety of suitable locations of marginal soils can be found by contacting the local offices of the Soil Conservation Service and U.S. Forest Service as well as the local Agricultural Extension Service. Soil classification and land use maps are available from these agencies as is direct assistance in locating marginal soils suitable for amendment with dredged material.

b. Type of placement site. The type of placement site determines whether it can be used for agriculture (that is, whether it is a short-term or long-term placement area). Short-term usage means 1-3 months' time for both the transfer of dredged material from a containment site and the transport, spread, mix, and cultivation of the dredged material for seedbed preparation at the agricultural site. Long-term usage implies that the agricultural site can be used as an active placement area over a long period of time (5-10 years). This would involve only a few acres of the agricultural site at any one time in applications of dredged material, so the rest of the field could be planted in crops. A schematic of a long-term placement area is shown in Figure 5-47, where various levels of dredged material are being used for different activities. Shallow-rooted crops such as grasses, small grains, soybeans, and vegetables can be cultivated in designated areas when dredged material is first applied (15-30 cm [6-12 in.] depth). However, as the application of dredged material is continued in specific areas of the field (1 m [3.3 ft] or more in depth), deep-rooted crops such as corn, sorghum, cotton, alfalfa, and trees can be successfully cultivated. On full or abandoned placement sites, these areas are already in active use in rural areas by farmers in Washington, Oregon, Minnesota, Maryland, Mississippi, Louisiana, Kansas, Missouri, Arkansas, South Carolina, Illinois, and Iowa (Landin 1997b).

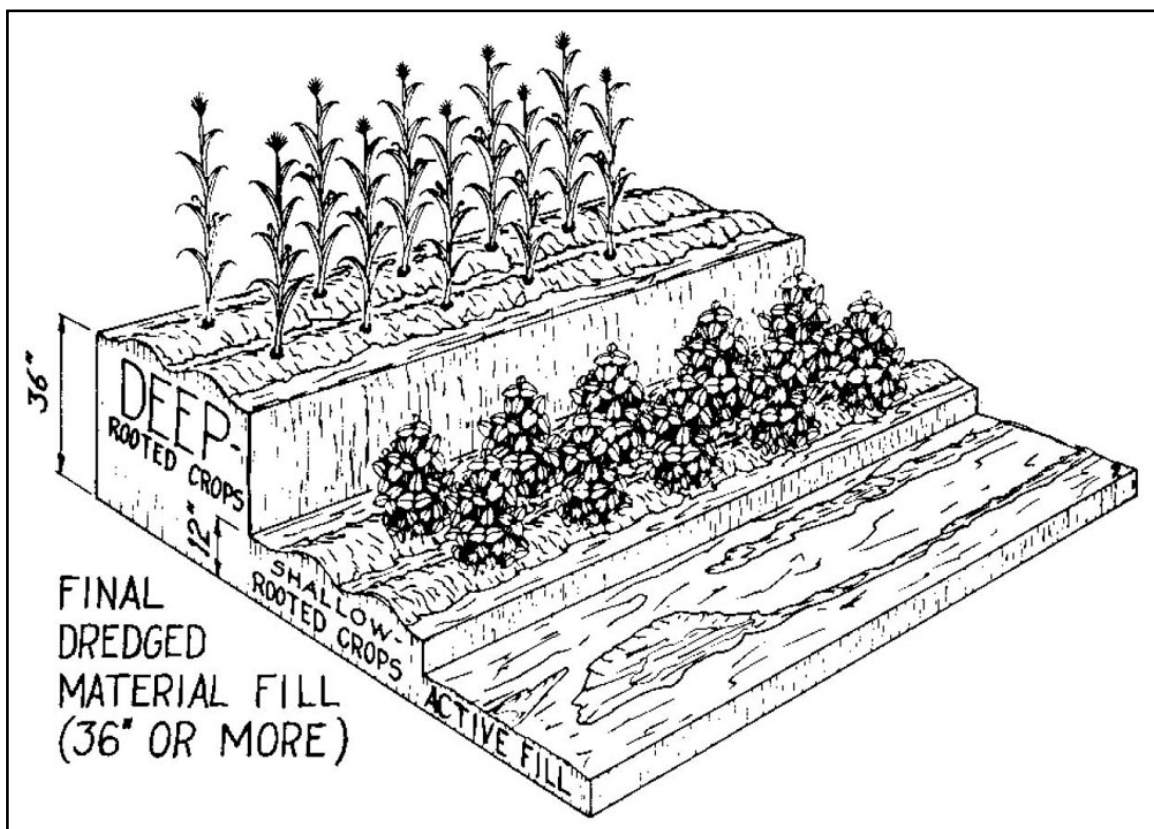

Figure 5-47. Schematic of a Long-Term Agricultural Dredged Material Placement Site (from Spaine, Llopis, and Perrier 1978)

c. Transport. The accessibility to the dredged material containment site and the agricultural site determines project viability and mode of transport. The agricultural site may have limited

access due to field roads, drainage ditches, and fence locations; therefore, access routes on a farm may require design and construction to facilitate the placement and spreading of dredged material. If the application of dredged material is to be efficient and effective, scheduling of dredged material application should not interfere with normal farm operations. Access roads to the placement site should circumvent the farmstead and avoid the location of poultry and livestock.

5.44.2 Agricultural site considerations. With an understanding of the characteristics of the dredged material at the various placement sites, consideration should be given to any potential problems at the agricultural site. Factors to be considered at the agricultural site are drainage of effluent, properties of the marginal soil, application depth of dredged material, land preparation needs, compaction, erosion potential, flood/drainage area, and seedbed preparation (Spaine, Llopis, and Perrier 1978).

5.44.2.1 Incorporation. The beneficial effects of incorporating dredged material into marginal soils are increased available water capacity, increased nutrient supply when fine-grained dredged material is mixed with coarse-grained marginal soils, and improved drainage when coarse-grained dredged material is mixed with fine-grained marginal soils (Lunz, Nelson, and Tatem 1984).

a. Marginal soil. Marginal soils are not used for production of crops due to low economic return. These soils can be unproductive pastures, abandoned fields, fields requiring excessive irrigation or drainage, or areas in various stages of degradation. These marginal soils can be brought to a loam soil classification and made productive for a variety of economic crops by incorporating dredged material.

b. Depth. Plant growth can be limited by root development; therefore, it is important to increase the depth of rooting media on marginal soils with applications of dredged material. To obtain an optimal mixture under normal field conditions, the depth of dredged material to be incorporated is limited to a 15 cm (6 in.) cover. At this depth, a 40 cm (16 in.) moldboard plow can furrow the 15 cm (6 in.) of dredged material to a depth of 30 cm (12 in.) using a tractor-plow combination. If incorporation of greater depths of dredged material is required, then special types of plows not common to normal farm operations must be used.

c. Land preparation. Tillage operations prior to the application of dredged material may be useful to speed surface drying and eradicate weeds. The application of dry dredged material to level soil surfaces presents few problems when the soil surfaces are dry. If the agricultural site has poor drainage, the application of dredged material should be done after the area has had an opportunity to dry. Row drains can be constructed with a plow that cuts through low areas to provide drainage into field laterals. The addition of dredged material to slopes ranging from 5% to 10% may increase operational problems and the potential for erosion as well as the sediment content in runoff water. If steep slopes (greater than 10%) are to be used, standard conservation practices should apply, possibly including terraces, grassed waterways, diversion channels, and supplemental practices such as contour farming, strip-cropping, and crop rotation (Spaine, Llopis, and Perrier 1978).



d. **Compaction.** The purpose of using dredged material is to improve the agricultural site; therefore, the application and spreading of the dredged material should not impair agricultural production by severely compacting the marginal soil. For example, soil compaction problems associated with the weight per axle load of large (23 tonne [25 ton]) dump trucks may necessitate using smaller (8 tone [9 ton]) dump trucks, which reduces soil compaction but increases transportation costs by 25%.

e. **Seedbed preparation.** The use of various types of tillage equipment is, to some extent, dependent on the type of crop to be produced. However, tillage operations such as plowing, disking, and harrowing are common to all types of seedbed preparation. The newly incorporated mixtures should be cultivated and planted as soon as possible because tillage increase the infiltration of water and reduce surface runoff, therefore lowering the potential for erosion.

5.44.2.2 **Soil cover.** When the area to be covered is too rocky, gravelly, or otherwise unsuitable for cultivation, additions or capping with dry dredged material to depths of 30 cm (12 in.) or more without incorporation into the existing site may be required to improve the area for agronomic production. When dredged material is to be used as a surface cover or cap, it is best that the texture approximate a loam soil for crop production. In the past 3 decades, this practice of providing soil cover for marginal sites has become common practice for strip-mined sites, including those that are being reclaimed in floodplains adjacent to waterways for forested wetland mitigation. Dredged material suitable for the necessary 0.6-1 m (2-3.3 ft) buffer layer between the strip-mined soils and the surface is feasible if the transport distance and costs are not excessive. Dewatered dredged material could also be trucked into such areas being reclaimed.

a. **Depth.** The depth of dry dredged material to be applied in increments as a surface cover or cap should be at least 1 m to ensure good drainage and an adequate rooting medium. This depth of 1 m or more can be achieved by additions of 15 cm (6 in.) layers if the agricultural site can be used as an active dredged material placement site over a period of years.

b. **Drainage and flooding.** When the soil depth is increased by additions of dredged material, the depth to the water table increases and reduces wet spots in the field, thus extending the period available for farming operations. If the area is only briefly and intermittently flooded, and does not meet jurisdictional wetland criteria, additions of 1 m (3.3 ft) or more of dredged material may completely eliminate the flooding problem. If it is flooded enough to have reduced soil conditions, it is a wetland and should not be used except in typical bottomland hardwood forest species or put into the NRCS Wetland Reserve Program.

c. **Erosion.** Slopes greater than 10% are not generally used for the application of dredged material in agricultural situations because the establishment of a vegetative ground cover is more difficult. When the dredged material is to be placed on erodible slopes, it should be planted in grass cover immediately until the dredged material has stabilized. If the agricultural site is a terraced area, the terraces should be seeded in a permanent vegetation cover to prevent accelerated erosion. Flat or nearly level agricultural fields found in floodplains are the most satisfactory for dredged material application and farming operations.

d. Seedbed preparation. When the marginal soil is to be buried with over 0.5 m (1.6 ft) depths of dredged material, it should be leveled with a bulldozer and other tractor-plow or disk combinations used for seedbed preparation. Any application of dredged material requires standard seedbed equipment preparations to level and till the site (for example, tractors, subsoilers/rip plows, disks, planters, fertilizer spreaders (Doerr and Landin 1983).

5.44.3 Crop selection. A number of agricultural or food crops have been or may be grown on dredged material throughout the United States adjacent to navigable waterways, the majority of them on old dredged material sites, not ongoing placement sites. These include pasture grasses; food grains such as rice, corn, wheat, oats, rye, barley, and millet; soybeans; sunflowers; truck crops; and cotton. Crop selection for food and forage use depends on climate, culture, and regional markets. The varieties of agricultural crops typically selected for production in any given area can be obtained from county and local Agricultural Extension Services and the county Farm Service Agency offices.

5.45 Horticulture. Horticulture crops are generally considered vegetable, fruit, nut, and ornamental varieties of commercially grown plants. Dredged material applications on soils for vegetable production, orchards, and nurseries do not differ from the guidelines discussed under agricultural planning and site considerations. This discussion limited to certain types of horticultural crops.

5.45.1 Vegetation production. All commercially grown vegetable truck crops can be produced on dredged-material-amended soils. Vegetables grow best on sandy loam soils of good texture, drainage, and aeration. The best types of dredged material mixtures for such crops are sandy silts or silty dredged material incorporated into an existing sandy site or sandy dredged material incorporated into an existing silt or heavy clay site. Clays, in general, are too heavy for good vegetable production, and they can be greatly improved by applications of sandy material. Some current excellent examples of truck crop production on dredged material occur in Washington State in sand containment areas on the north banks of the Columbia River, where table vegetables such as sweet corn and cabbages are grown (Landin 1997b) (Figure 5-48). Historically, American Dredging Company dredged material containment sites along rivers in New Jersey were used by the Campbell's Soup Company in the nineteenth and early twentieth centuries for truck crop production for use in their canneries. This use would not now be encouraged or allowed without intensive sampling for contaminants due to locale and the source of the sediment in the containment sites, but 100 years ago such things were not known or considered.

5.45.2 Orchards. Few fruit and nut crops are produced close to waterways and dredging sites with the exception of pecan and black walnut orchards. In general, pear/peach/apple orchards and other pome fruits grow best on hillsides and out of low bottomlands, and citrus orchards generally grow best away from the influence of salt spray. Although no placement sites have been planted as pecan or black walnut orchards, such application is feasible. Additional applications of dredged material once trees are established would have to be limited to not more than 15 cm/96 in.) to prevent damage to root systems due to soil aeration changes. Pecans and black walnuts are bottomland hardwood species and, therefore, tolerant of limited flooding and

inundation and silt deposits. Black walnut has much greater value as a commercial furniture species than as a nut crop, but it could be a combination crop of nut production and timber harvest once trees reach adequate size. Pecan is also a furniture wood, but the value of nuts far exceeds the value as furniture wood due to several highly productive pecan cultivars, such as Stewart and Schley (Landin 1997b).



Figure 5-48. Sweet Corn Growing on Dredged Material Inside a Containment Area

5.45.3 Ornamental plant nurseries. Ornamental liner shrubs in nurseries are grown two ways: potted or set in the ground in a high-quality soil mixture. Both types require horticultural soil mixes of loamy soil, sand, peat, and vermiculite. Dewatered dredged material could be applied as a part of the soil mix in areas where soil must be trucked into nursery sites at considerable expense. Most commercial nurseries make their own soil mixes, and may be amenable to use of good quality dredged material. The major disadvantage is the limited quantities of material a nursery requires. The USACE Engineer Research and Development Center (ERDC) has conducted partnered research on soil mixtures using dredged material for a number of years (Cadet, Lee, and Sturgis 1977; Sturgis, Lee, and Taplin 1997; Sturgis, Lee, and Langan 1997). These applications include not only agricultural and horticultural soil mixtures, but brick and road aggregate manufacture of dredged material.

5.45.4 Sod farms. Urban and suburban areas require large quantities of readily available grass sod for such uses as residential lawns, parks, golf courses, and rights-of-way. Unless sites

31 Jul 15

are available near these high-population areas for sod production, sod must be trucked into the area for sale by retail nurseries and garden shops. Level sites with marginal soils near urban centers could be brought into grass sod production through applications of dredged material. Since grass sod is less exacting in its growth requirements than most food crops, the type of dredged material used is not as critical. However, the material should be a loamy or silty sand substrate, if possible, to ensure best grass growth, and the receiving site should be level or nearly so after dredged material has been dewatered.

5.45.5 Christmas tree farms. Another specialized use of dredged material is the cultivation of Christmas trees on placement sites (Spaine, Llopis, and Perrier 1978; Landin 1997d). This has already been carried out successfully in the Baltimore and St. Paul Districts. Since Christmas trees require 5-8 years to reach marketable size, the placement site or compartment on larger placement sites is generally unavailable for such beneficial use. This limits the feasibility of this option in most waterways where dredging occurs. If dewatered material were trucked (at sponsor expense) to a marginal soil site, then planted with trees, this beneficial use option would be more acceptable.

#### 5.46 Forestry.

5.46.1 For a number of years, the timber industry has been working with tree genetics to produce faster growing, stronger trees, and with the reclamation of disturbed eroding sites using trees, primarily yellow pine species. However, some hardwoods and black walnut have been tested in the north-central United States, and numerous cottonwood, sycamore, sweet gum, and eucalyptus plantations for paper production have been planted in the southern United States. The improvement of marginal timberland with applications of dredged material would be received with interest and enthusiasm from foresters who have the problem of trying to produce timber on poor soil. There are several rapidly growing pulpwood species that may be grown in large placement sites with several compartments once the compartments are nearing completion. Dewatered dredged material trucked to marginal land or use of abandoned placement sites would be the two options most appropriate for timber production. In the Tennessee-Tombigbee Waterway, several of the 5,666 ha of containment areas have been planted with pulpwood species as commercial enterprises (Hartley 1988).

5.46.2 The same physical and chemical soil properties discussed under agricultural considerations would apply to forestry except that trees can be grown safely on dredged material with higher contaminant levels than could food crops. This is an encouraged ecological use of contaminated dredged material because of the long growth cycles of trees. Passage of time gives the site an opportunity to recover or "self-clean," and the trees can still be harvested for commercial timber after maturity. The tolerance level of each timber crop for heavy metals and other contaminants and the physical characteristics of the material would be forestry limiting factors.

5.46.3 Since land would be tied up in tree production after planting for 10-50 years, the primary disadvantage of this beneficial use would be loss of placement sites. An advantage would be use of moderately contaminated dredged material not suitable for many other beneficial uses. Dredged material trucked into a site could be spread with heavy equipment as deeply as

desired by the forester since tree roots penetrate several feet into the substrate. Large quantities of dredged material could be placed on marginal sites in this manner and made productive.

5.46.4 Short-rotation commercial tree species that would be suitable for timber production on dredged material at periodically flooded (limited flooding) sites are eastern cottonwood, American sycamore, eucalyptus, green ash, water oak, and sweet gum. These species would also have a shorter rotational requirement of 5-15 years. Long-rotation commercial species include long-leaf pine, slash pine, loblolly pine, black walnut, white ash, pecan, and several oak and hickory species; they would grow best in bottomlands and moist upland sites amended by dredged material applications and are recommended only for dredged material placement sites that have been taken out of rotational placement of material.

#### 5.47 Aquaculture.

5.47.1 The USACE interest in aquaculture stems from its basic mission in construction and operation of navigable waterways. Due to the increasing difficulty and expense of obtaining dredged material containment acreage for use as single-purpose areas, the development of a multiple-use strategy such as aquaculture is desirable. It is possible that future site availability would be improved by increased value of acreage leased to dredging project sponsors because landowners could enter separate and profitable lease agreements with aquaculturists (C-K Associates, Inc., 1993). Aquaculture is attractive because of the potential for producing nutritious low-cost protein; partially satisfying increased demand for seafood in the United States; increasing employment in fish farms, feed mills, processing plants, and other supporting industries; and providing larval stock for commercially and recreationally important natural populations currently stressed due to pollution and habitat loss. Aquaculture activities would also generate a more positive public image of the USACE and its activities.

5.47.2 Aquaculture in a dredged material containment area was first explored by the USACE during the Dredged Material Research Program (DMRP). In 1976, Dow Chemical Company, under contract to the USACE, successfully cultured a crop of white shrimp in an active containment area near Freeport, TX (Figure 5-49). This project demonstrated that dredged material containment site environments are compatible with aquaculture in the sense that animals will grow, survive, reach marketable size, and be of marketable quality within a given dredging cycle. No attempt was made in the 1970s to justify the production economics of the project: the cost of post-larval white shrimp stock, the limited acreage, and the small size of the unfed white shrimp at the time they were harvested all contributed to high production costs (Lunz, Nelson, and Tatem 1984).

5.47.2.1 Advances in technology. Many of the technology problems that affected production economics during the 1976 dredged-material demonstration at Freeport, Texas, have been solved through continuing research on the biology and culture requirements of desirable plant and animal species into the early 1990s. It is now possible, for example, under laboratory conditions, to duplicate the life cycle of the white shrimp species used in that study. One advantage of this technology is a reduced cost of obtaining juvenile shrimp compared with the cost of field excursions for capturing egg-carrying and recently mated female shrimp in the wild, and returning them to a laboratory for spawning. Another very significant advantage is that artificial



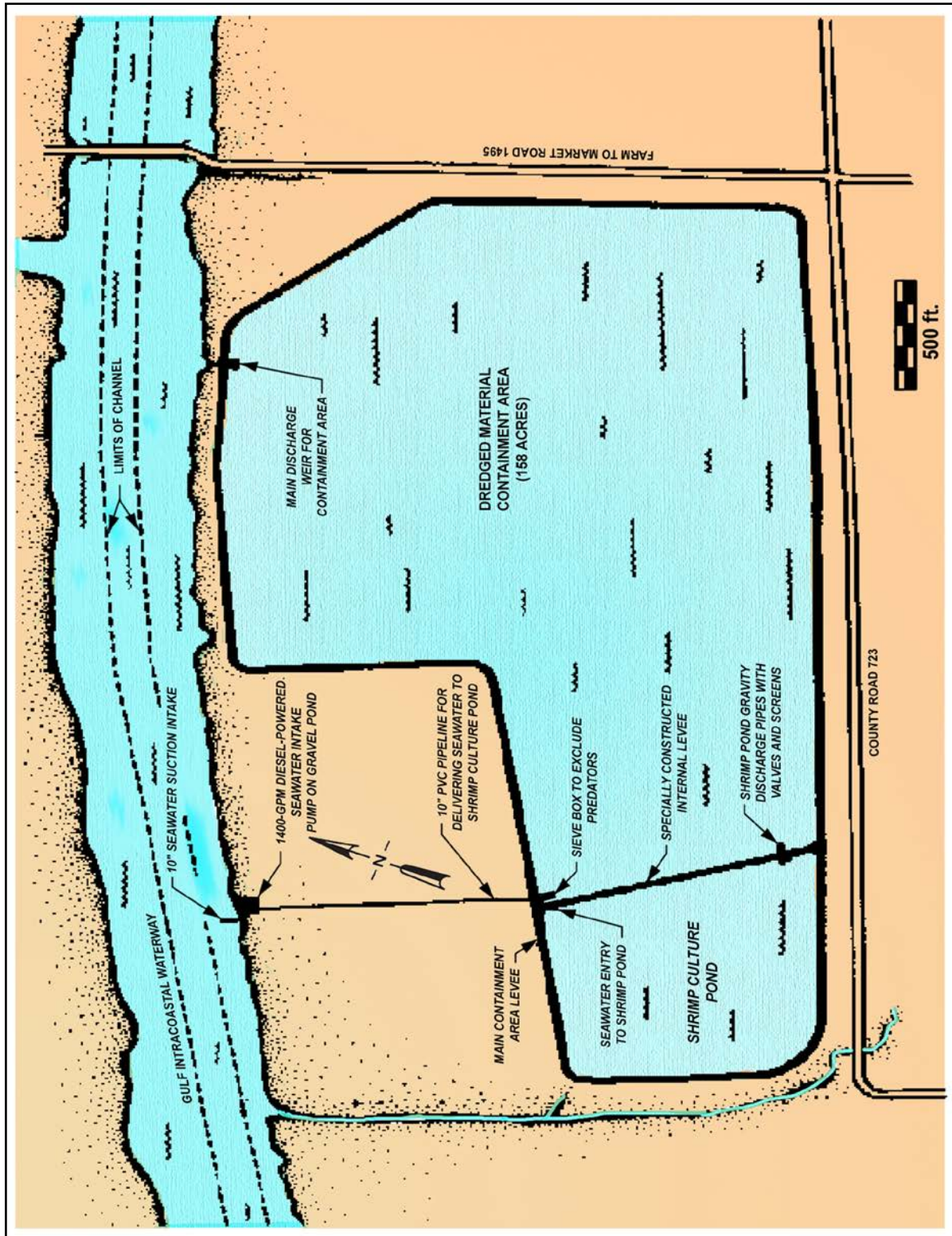

Figure 5-49. Galveston District Dredged Material Containment Area No. 85, Showing the Shrimp Pond, Internal Levee, and Associated Structures; this Site was Successfully Used for Shrimp Culture for 3 Years in an Experimental Field Test

control over the natural reproductive cycle permits production of juvenile shrimp whenever they are needed and allows production of multiple crops in a single growing season. The result is more efficient use of the cultivation area, higher annual production, and lower net production costs.

#### 5.47.2.2 Favorable economics.

a. Dredged material containment sites commonly possess structural features such as dikes and water control devices that may enhance their suitability as aquaculture areas. In some instances, land acquisition costs (purchase or lease) and dike and water control structure costs are absorbed wholly or in part by the Federal government or a local cooperator on the dredging project, such as the city government or port authority. In cases where a Federal or local subsidy exists, the aquaculturist could be the beneficiary. The lack of available coastal sites has been one of the principal restraints on the application of commercial aquaculture techniques. This is due both to the cost of real estate and to the Government's regulatory permitting process, which affects consideration of aquaculture in coastal lowlands, particularly wetlands. Freshwater and coastal dredged material containment areas have several benefits related to desirable location: proximity to favorable water sources, waterfront property use that may otherwise be unavailable to the aquaculturist, and nearness to large market areas and established transportation routes.

b. Dikes that serve to contain the dredged material also serve to impound the water necessary for aquaculture. However, dikes of an existing containment site that is under consideration for aquaculture may have to be modified to increase their height, adjust their slopes, or improve their water-retaining capabilities. At a new containment site, the dikes could be designed to permit both the containment of dredged material and the retention of water for the aquaculture operation. Water control structures that are used to regulate water quality at containment areas could also serve to regulate water exchange rates and levels in an aquaculture pond, and could be used to drain the pond or concentrate the crop for harvesting.

#### 5.47.2.3 Aquaculture considerations.

a. Compatibility between aquaculture and dredged material management. There are at least two general containment site management techniques that could be compatible with aquaculture. Figure 5-50 depicts the placement of dredged material into a containment area surrounded by a single primary dike system. Distribution of the dredged material would depend on the size (surface area) of the containment, the relative volume and physical characteristics of the dredged material, and the use of controlled placement operation conditions such as pipeline placement and movement. It is unlikely, though not impossible, that culture operations could be sustained within the site during active placement. A small volume of dredged material disposed into a large placement site containing a species tolerant of suspended sediments is one workable scenario. Figure 5-50 also depicts a containment site divided into multiple compartments or cells that would be filled sequentially over the life of the placement site. Construction of secondary, internal cross dikes produces a configuration with numerous operational advantages over an undivided one. The most obvious benefit would be related to the separation of one or more cells from dredged material placement operations. The second configuration has an additional benefit

31 Jul 15

in a new site because it also separates the aquaculture operation from potentially contaminated dredged material. This is a source of perceived, if not actual, production or marketing problems.

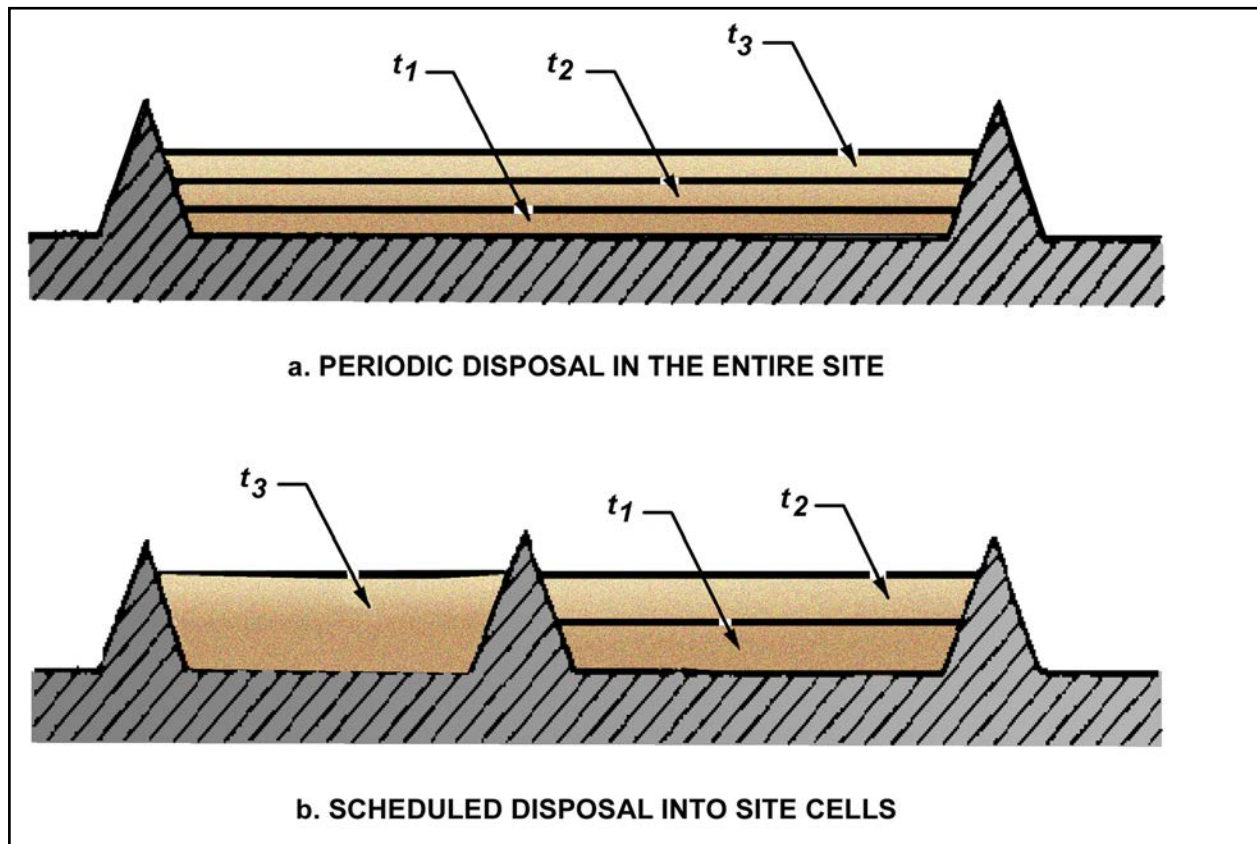

Figure 5-50. Two Concepts for Combining Dredged Material Containment and Aquaculture Operations ( $t$  = Time in Years; May Vary Between 1 and 15 from Site to Site)

b. The length of time following a placement event before aquaculture activities could begin is a site-specific variable—it depends on the site size and configuration, the volume and character of the dredged material, and the possible use of dredged material dewatering and other volume-reducing techniques for efficient containment site management. A site without cross dikes is not available to aquaculture during the active dewatering period. Otherwise, aquaculture and dewatering objectives are totally compatible.

5.47.2.4 Aquaculture products. Aquaculture products in containment sites could be designed to produce crops for commercial harvest or could be directed toward producing fish and shellfish stocks for release to augment depressed natural populations. Current aquaculture-for-release programs in California, Texas, the Pacific Northwest, Japan, and the Middle East use natural and artificial coastal ponds, lagoons, and embayments for their propagation programs. Similar programs could easily be undertaken in containment areas.

5.47.2.5 Site characteristics. Containment sites exhibit a wide range of variability: location, size, construction, compatibility of aquaculture with placement requirements, and a myriad of



other site-specific physical and chemical features that make each containment area unique. Not all containment sites are suitable for aquaculture, but a significant number have the proper combination of features to support aquaculture. Crucial to developing aquaculture as a secondary use of containment sites is the fact that aquaculture is possible only if it is compatible with the placement requirements and schedules imposed by the intended primary use of the site (that is, dredged material placement). Only when both the aquaculturist's and the placement agency's requirements are met can the site be developed for aquaculture.

5.47.2.6 Site acquisition and permitting. Site development and pond management practices are expected to be similar to those presently used in commercial aquaculture operations. Major exceptions lie in the areas of site acquisition by entrepreneurs and permit-granting procedures. Existing easement agreements have to be amended, requiring prospective aquaculturists to reach separate agreements with both the property owner and the USACE. Representatives of commercial aquaculture enterprises claim that the current permitting process is so involved and complex that the growth of aquaculture in the United States is effectively thwarted. Having the USACE involved in promoting aquaculture in addition to retaining its traditional role in the permitting process could possibly expedite the process in the future (Robertshaw, McLaughlin, and Love 1993).

#### 5.47.2.7 Use of contaminated sediment.

a. Waterway and harbor sediments placed into containment sites are sometimes contaminated with elevated concentrations of heavy metals, pesticides, petroleum hydrocarbons, and PCBs. Inorganic contaminants, such as metals, are generally incorporated in sediment particles while organic contaminants, such as petroleum hydrocarbons and PCBs, are generally associated with organic material present in the sediments. Because of the way contaminants are retained within sediments, they are relatively unavailable to aquatic animals; those that are available are generally not concentrated by aquatic animals to levels much in excess of those found in the sediments.

b. Laboratory experiments in which aquatic animals were exposed to sediments contaminated with various metals and organic contaminants have shown that the organics are more likely to be transferred from sediments to animals. Animals such as certain marine worms that live and feed below the surface of the sediment are more likely to accumulate organic compounds like PCBs than most shrimp or clams, which live or feed at or above the surface of the sediment. Higher levels of organic material in the sediment appear to reduce the biological availability of PCBs and other organic chemicals in sediments. There are some data to indicate that animals can accumulate lead and petroleum hydrocarbons from contaminated sediments, but the levels of these contaminants found in these animals are low in comparison to sediment levels, and there is no evidence that they are harmed by these low levels of contamination.

c. Most studies generally focused on highly contaminated sediments and should be viewed as representing the "worst case." The placement of dredged material with "some contaminants" need not be viewed as a major constraint to the use of the containment site for aquaculture. Test procedures for determining whether a particular sediment will be a problem to a specific aquacultured species are available, fast, and inexpensive. Contaminant status is something to be considered during the planning process.

5.47.2.8 Economics. The economic and marketing requirements of commercial finfish and shrimp culture operations and those operations conceived for containment areas are very similar. The capital investment requirements of containment area aquaculture could be significantly less. Simplified land acquisition, reduced real estate costs, shared costs of dike construction and maintenance, and the possibilities of an expedited permitting process all contribute to reducing capital requirements. Operating costs depend on site- and species-specific characteristics and are difficult to describe in general terms, but no extraordinary additional costs have been identified.

#### 5.47.2.9 Pond construction and management.

a. Pond construction and modification for aquaculture would be site and species specific. If a containment site satisfied initial geotechnical and engineering requirements, constructing additional dikes, installing water control equipment, and other necessary modifications should follow the procedures employed in conventional operations. Cooperative efforts involving aquaculturists, the USDA NRCS, and the USACE are recommended for developing designs and specifying any modifications necessary for using containment areas for aquaculture (Homziak, Veal, and Hayes 1993).

b. Health considerations, water quality, and species management techniques for containment site culture should be identical to current practices although the effects of large amounts of fine sediment in the containment area ponds and the lack of experience in managing large-scale aquaculture operations pose questions that still need to be answered. Management procedures for large ponds have not been developed for many species simply because large ponds have not been generally available. With increased availability afforded by the widespread use of containment site acreage, appropriate techniques should evolve. Similarly, adequate water exchange, aeration, and harvest techniques should overcome many difficulties created by the presence of large amounts of fine sediments.

#### 5.47.2.10 Feasibility.

a. Aquaculture in active dredged material containment areas appears to be a feasible, cost-effective, and compatible multiple use of containment sites. Existing technology can be directly applied to the concept, making it practical with little additional research and development investment required. The needs of the local areas, interests of the involved parties, and technical constraints will determine which type of culture operation (commercial or stock augmentation) and which species will be most suitable for a given site. Aquaculture is generally perceived in the United States to be applicable only in warmer climates. However, it is practiced commercially in Arkansas, the Pacific Northwest, California, New England, the Chesapeake Bay, and the Carolinas as well as in Louisiana, Mississippi, Florida and other Gulf Coast states. Although growth rates are generally slower in colder waters, the concept is still highly applicable. Mississippi has over 50,000 ha of freshwater aquaculture ponds, the largest such aquaculture production in the United States, but few of these aquaculture ponds are close enough to a navigable waterway to make use of aquaculture in a placement site.

b. The large successful freshwater industries centered on catfish, crayfish, salmon, trout, and bait minnows can provide both the technical expertise and the sources of stock needed for

developing a profitable operation. The technology involved in freshwater fish culture is both well defined and compatible with culture plans envisioned for containment areas. Redfish, exotic and native shrimp, hybrid striped bass, bait shrimp, and minnows are the most promising species for marine/brackish water culture. At the present time, lower costs of marine/saltwater aquaculture in Asia and Central and South America keep this from being a financially viable industry in the United States.

## Section XI

### Strip Mine Reclamation, Solid Waste Landfill, and Alternative Uses

5.48 General. Four beneficial uses of dredged material that are still fairly new concepts have proven to be feasible in laboratory, field, and District tests (Bartos 1977b; Spaine, Llopis, and Perrier 1978; Landin 1997a): the reclamation of abandoned strip mine sites that are too acidic for standard reclamation practices, the capping of solid waste landfills (Spaine, Llopis, and Perrier 1978), the use of material to protect landfills, and the use of material to manufacture bricks and hardened materials such as road surfaces. All uses require reliable quantities of dewatered dredged material that could be moderately contaminated and still be acceptable. These uses would ultimately provide nonconsumptive vegetative cover to unsightly areas, and the areas could be further reclaimed for minimal-use recreation sites and/or wildlife habitat. Spaine, Llopis, and Perrier (1978) provide excellent discussion of the first two types of beneficial uses. The techniques discussed in this chapter also apply to pyrite soil reclamation, gravel pits, and rock quarries. The St. Paul District has reclaimed an abandoned gravel pit, and the Portland District has reclaimed a rock quarry using these techniques.

5.49 Strip Mine Reclamation. Various techniques have been developed to control acid mine drainage from surface mine tailings. The primary purpose of these techniques is to reduce air and water contact with the acid-generating mine tailings. Methods to accomplish this are reducing slopes, thereby lowering runoff velocities and erosion, and establishing plants on the mine tailings. A balance must be struck between slope reduction and increased infiltration capacity. Attempts to establish vegetative cover on highly acidic mine tailings have usually resulted in low survival rates. The lack of a vegetative cover on mine tailings results in erosion and further exposure of acid-generating pyrites to air and water (Spaine, Llopis, and Perrier 1978). In order to reduce adverse effects of mine tailings, placement of a topsoil or topsoil substitute suitable for vegetative growth such as dredged material is recommended. Application of dredged material to surface mine tailings provides a cover that reduces the infiltration of water and the diffusion of air to the pyrite material; it also provides a suitable growing medium for vegetation. Planning must be coordinated with the landowner and, if the mine is an active surface mine, the mining operator. In addition, before reclamation activities can commence, State reclamation laws concerning the final grade of the area, cover requirements, and vegetation requirements must be assessed. Assistance for various aspects of surface mine reclamation can be obtained from State reclamation departments, county agricultural extension offices, the USDA NRCS, and the U.S. Office of Surface Mining.

5.49.1 Dredged material requirements. Dewatered dredged material can be used for surface mine reclamation in much the same way as topsoil or agricultural soil. If construction on the site

is considered as the final land use for the reclaimed mining area, tests for consolidation shear strength and permeability should be performed on the dredged material as well as on the mine tailing. Fractions of dredged material having different grain sizes can be mixed to provide a surface with desirable physical and engineering properties. Almost any desired soil property can be obtained by dewatering, mixing, and compacting dredged material (Bartos 1977b). Fine-grained or sandy silt dredged material can be used as a cover on mine tailings for the establishment of vegetation. Dewatered dredged material having a loam texture is the most desirable for best vegetation growth. The dredged material should be tested for pH, organic content, and soluble salts. It should have a nearly neutral (6.0-7.5) pH, a minimum organic content of 1.5% by weight, and a low amount of soluble salts (500 ppm or less) to allow optimum plant growth.

5.49.2 Site preparation and dredged material placement. The amount and method of site preparation needed at surface mines depend on the topography, the method of mining performed (for example, area, contour, strip with mining tailing mounds, or open pit), and the final land use. Site preparation consists chiefly of regrading the surface mine to a configuration that will accommodate a dredged material cover at a desired thickness and slope to support vegetation. The two principal surface mining techniques are area and contour mining. The potential for groundwater percolation and contamination should be determined for both the mine tailing and the dredged material.

#### 5.49.2.1 Area mining reclamation.

a. The area mining method produces the characteristic topography of a series of parallel ridges or piles of mine tailing. Site preparation consists of leveling mine tailing ridges or piles to a width specified by law and/or final land use. Leveling or “striking off” mine tailing ridges is accomplished by bulldozing the ridges into the valleys between ridges. The mine tailing piles should be leveled to a topography where conventional earthmoving equipment can spread dewatered dredged material to a desired thickness (Figure 5-51). This method of leveling was field tested by the Chicago District at Ottawa, IL. The mining site was leveled, capped with dewatered material, mixed, soil amendments added, and planted in a grass mixture. The site established vegetative cover rapidly and is very successful (Perrier, Llopis, and Spaine 1980). It still maintained good vegetation cover 8 years after planting.

b. An alternate concept of reclaiming area mines is the use of slurried dredged material. This method to date has not been field tested, but it appears promising. It consists of hydraulically pumping dredged material through a pipeline onto a prepared area mine. This form of reclamation is feasible only for area mines located within pumping distance of an active dredging operation or rehandling basin. Preparation of the site consists of grading mine tailings to a fairly uniform level and constructing dikes around the area to contain the slurried dredged material. Because of the high water content of the slurry, it must be pumped in lifts and allowed to dewater before adding the next lift. The depth of each lift depends on the final land use and time constraints (Montgomery et al. 1978). If the area is to be used for foundation material to support lightweight structures, the lifts of slurried dredged material should be limited to about 1 m (3.3 ft) so that drying will be enhanced (Lunz, Nelson, and Tatem 1984). The dredged

material should be allowed to dry to a moisture plastic limit before adding the next lift  
(Montgomery et al.

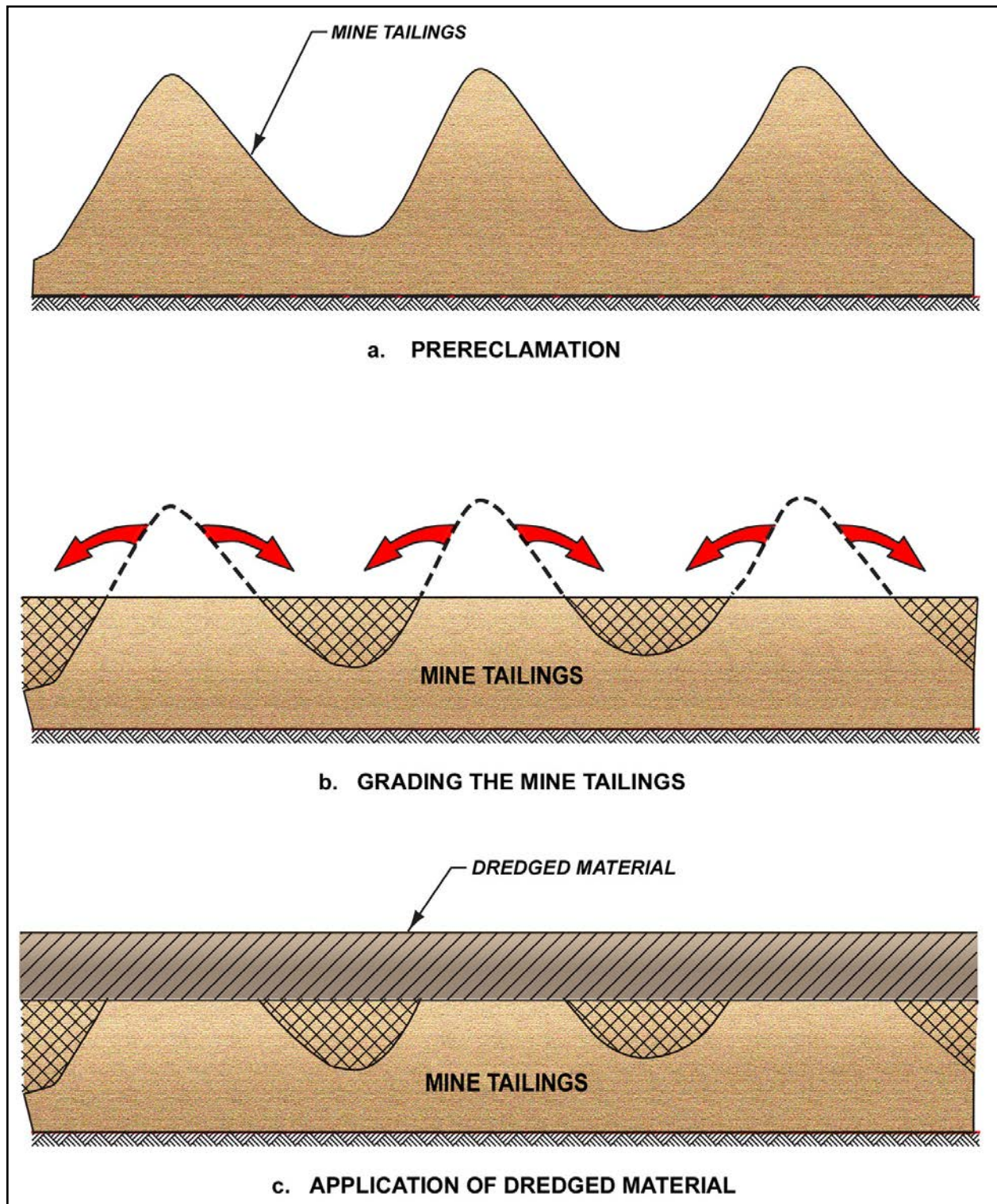

Figure 5-51 Schematic Diagram Showing Operational Techniques Used to Reclaim a Surface Mine Tailing with Dredge Material

1978). If the area being reclaimed is not planned to support structures and is being reclaimed mainly for recreation or vegetation establishment, the depth of each lift can be increased, and the amount of time between lifts can be shortened.

#### 5.49.2.2 Contour mined land reclamation.

a. The reclamation of contour mines is more difficult due to the hilly terrain in areas where this type of mining occurs. This technique of mining requires removal of the overburden by starting at the outcrop of the coal seam and proceeding along the contour around the hillside. The highwall is located on the uphill side while a rim and steep downslope are covered by the tailing material cast down the hillside. Being above the grade of local drainage, water from the pits flows directly into natural waterways. Reclamation of contour mines involves backfilling and terracing the disturbed land to the approximate original contour or to a contour compatible with the surrounding terrain. This requires placing dredged material into strip pits and over the mine tailing cast downhill (Figure 5-52). a.

b. The choice of which regrading technique to use for reclamation depends on many variables, including final land use, terrain, amount of dredged material, and state and Federal reclamation requirements. Concepts for using dredged material on contour mine backfill are shown in Figures 5-52 through 5-54. The use of dredged material to reclaim the mine to the original ground surface level and contour is demonstrated in Figure 5-52. The mine tailing on the downslope is also covered with dredged material to provide a vegetative media. Figure 5-53 shows the use of the Georgia V-ditch technique, which does not fill to the original soil surface but leaves a highwall and fill section to be leveled to support vegetative as well as agronomic production. The slope reduction technique, as shown in Figure 5-54 permits stockpiling of dewatered dredged material before final grading to original slopes and contours.

#### 5.49.3 Vegetation establishment.

5.49.3.1 Establishment of a quick vegetative cover is important at reclamation sites for it is one of the most effective erosion control methods (Perrier, Llopis, and Spaine 1980). It must be known whether the area is ultimately to be used for farming, grazing, construction, temporary soil stabilization, restoration for aesthetics, or other purposes. Plant species should be chosen that are able to adapt to dredged material conditions (such as low pH, high moisture, grain-size distribution, and fertility level) as well as to the climatic conditions (sunlight exposure, temperature, wind exposure, rainfall) found at the site. It is best to choose vegetation native to the area that can be easily propagated. A species mixture should be planted to ensure successful establishment of a vegetative cover (Perrier, Llopis, and Spaine 1980).

5.49.3.2 It is desirable to roughen or cultivate the dredged material surface before seeding in order to reduce the velocity of rainfall runoff and increase water infiltration to seedbed depth. The surface of the dredged material should not be compacted because this impedes seedling emergence. Common methods for preparing the surface of the dredged material are scarification, tracking, and contour benching or plowing using disks, harrows, and tractors. Tracking grooves made by the cleats of a tractor should run parallel to the contour. Contour benching is performed



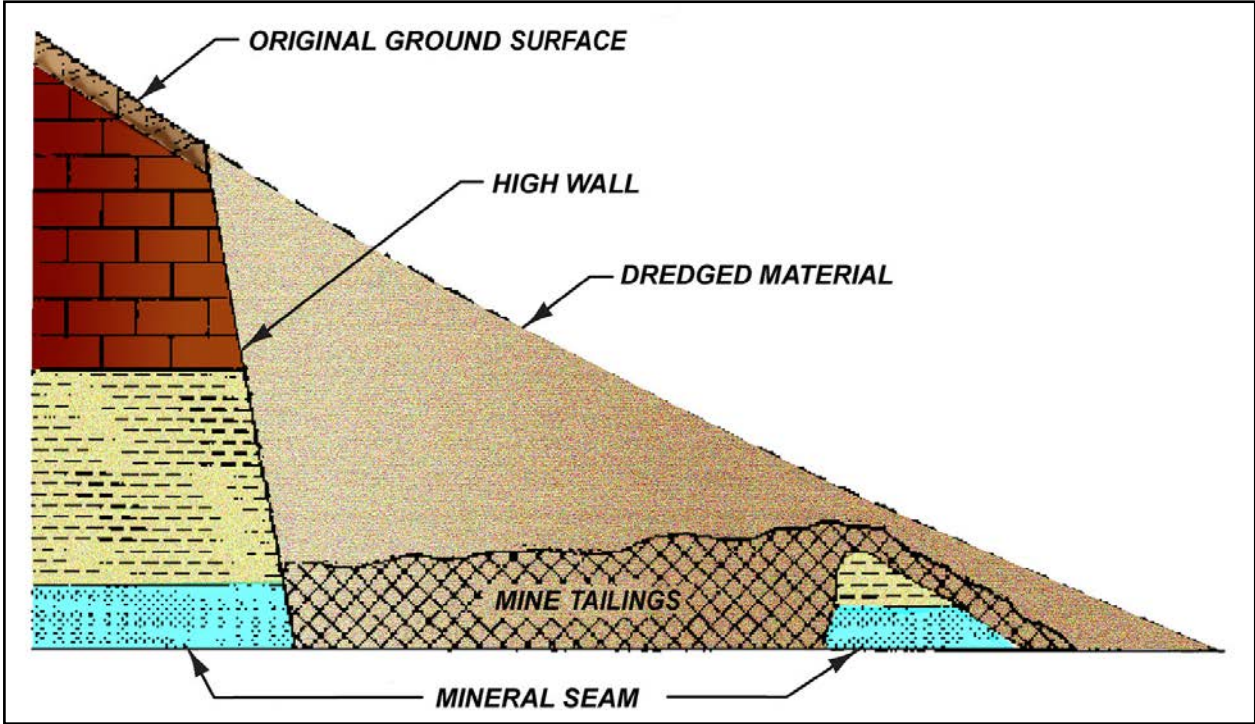

Figure 5-52. Cross-Sectional View of the Contour Backfill Technique

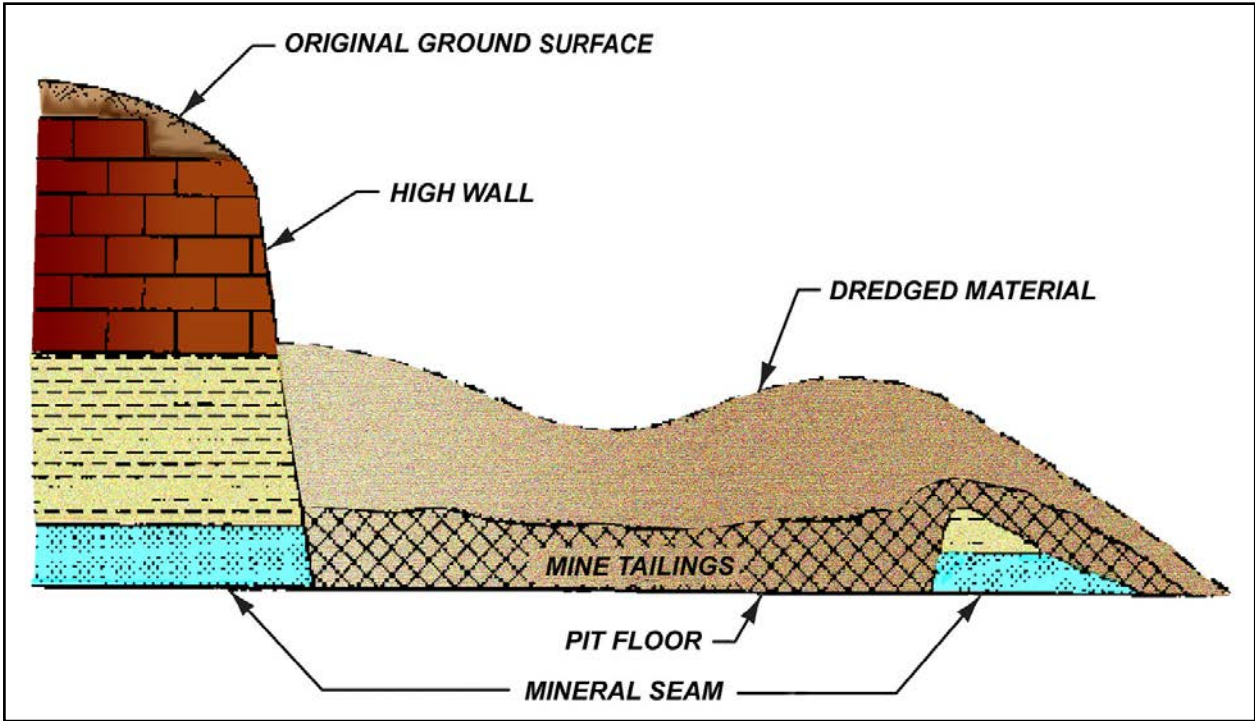

Figure 5-53. Cross-Sectional View of the Georgia V-ditch Backfill Technique

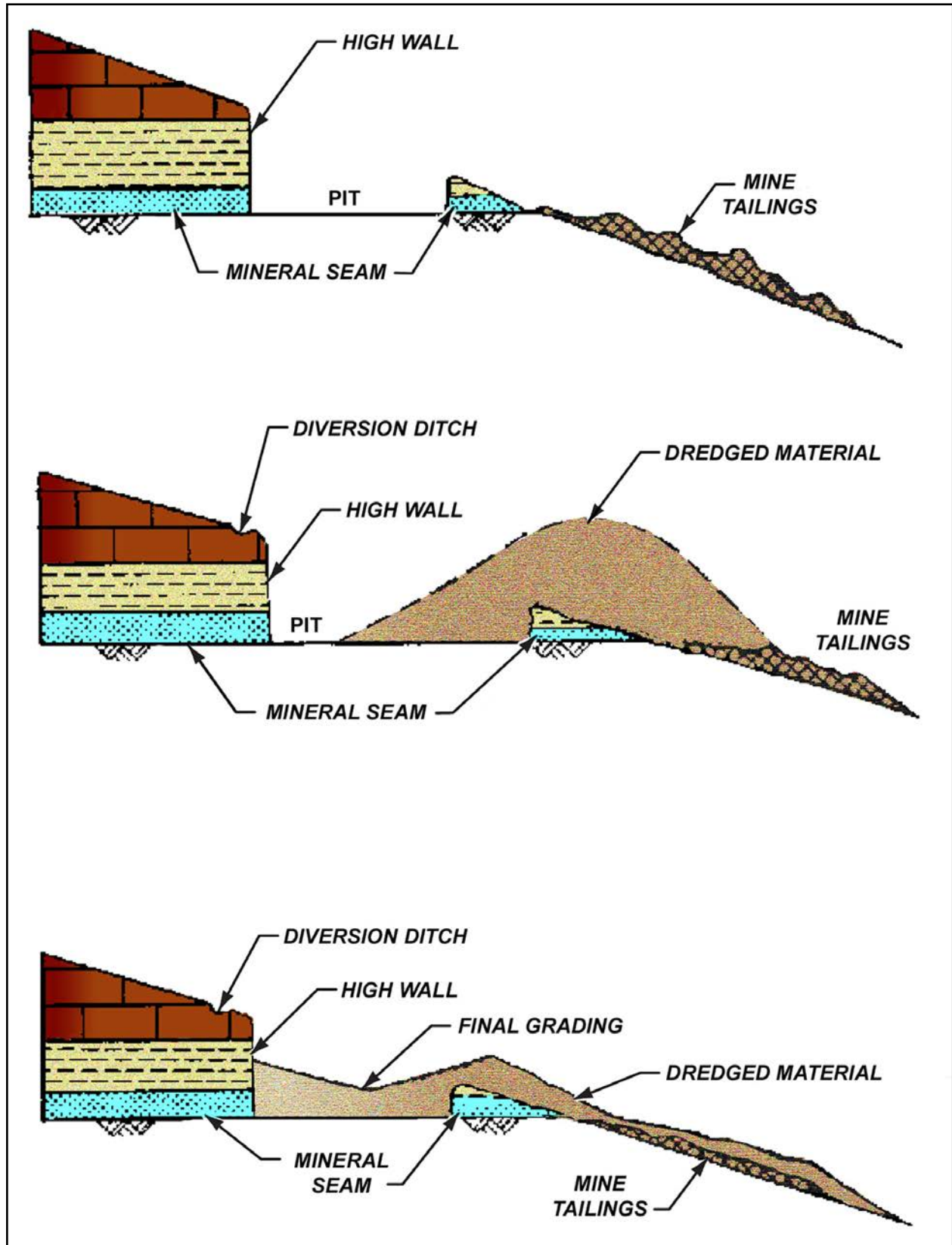

Figure 5-54. Schematic of the Slope Reduction Technique (from Spaine, Llopis, and Perrier 1978)



on long slopes to build terraces to reduce the velocity of rainfall runoff (Spaine, Llopis, and Perrier 1978). Terracing is performed with a bulldozer running parallel to the contour, allowing the soil to dribble off the edge of the blade. Furrowing of a terrace is performed by repeated plowing parallel to the contour. Other methods for planting such sites are available in Doerr and Landin (1983) and Hunt et al. (1978). Dredged material should not be placed on a frozen or muddy slope or when the subgrade is excessively wet or in a condition that may be detrimental to proper grading and the proposed seeding. Hydromulching or mechanical mulching on new cuts, revetments, dikes, and terraces is also usually required to prevent erosion.

5.49.4 Site selection. Mining sites that would be suitable for dredged material placement for reclamation purposes must meet certain criteria. The mined areas should be assessed for transportation capabilities as well as qualitative considerations, such as social and environmental concerns. Field investigations of potential sites should include such general factors of the site as geology, groundwater, effluent standards, ambient water quality, land costs, drainage, surrounding land use, and vegetation of adjacent lands. Permission for site use must also be obtained. Transportation costs are a major consideration and are generally at sponsor expense. For this reason, mines that are near placement sites and/or suitable transportation systems are probably the only ones feasible for consideration.

5.50 Solid Waste Landfills. Governmental agencies responsible for the management of solid waste are experiencing difficulties in obtaining suitable sites on which to operate environmentally sound solid waste placement operations. A major portion of the solid waste generated in this country is ultimately placed on land in sanitary landfills. The location of a sanitary landfill is often constrained by the cover material requirements and availability and the site characteristics related to potential adverse environmental impact. Bartos (1977a) reports that dredged material can satisfactorily perform the functions of a cover material, thereby making it possible to locate sanitary landfills at sites previously considered unsuitable due to a lack of native cover soil. St. Paul and Mobile Districts have both used clean dredged material as caps for urban landfills. This paragraph is intended to aid planners in determining the suitability of dredged material for productive use in solid waste management schemes and to provide guidance for development of possible landfill projects (Bartos 1977a; Spaine, Llopis, and Perrier 1978).

5.50.1 Dredged material characteristics. The potential uses for dewatered dredged material in a sanitary landfilling operation are as a material for covers, liners, gas vents, leachate drains, and gas barriers. Section I, "Dredged material as a Resource," presented a discussion of physical and chemical characteristics to be considered when using dredged material in a land improvement project. Some dredged material grain-size distributions are generally more suitable than others.

5.50.1.1 Cover. The solid waste in a sanitary landfill is covered daily with at least 15 cm (6 in.) of material to prevent an unsightly appearance, control vectors at the site, prevent internal fires, and control surface water infiltration. Landfills with two or more lifts must have intermediate covers 30 cm (12 in.) deep between lifts. The intermediate cover must fulfill all functions of a daily cover for up to 12 months and must be trafficable to assist vehicle support and movement. Dredged material characteristics of a desirable cover material are easy

workability, moderate cohesion, and significant strength. A mixture of sand, silt, and clay has been shown to be a suitable cover material; if a gravel is fairly well graded with 10-15% sand and 5% or more fines, it can make an excellent cover. The only types of dredged material eliminated for use as cover are highly organic materials and peat. Due to the difficulty in handling, dredged material should not be used in the slurry state. On the other hand, the use of dewatered dredged material as cover is operationally feasible because the material can be easily hauled, spread, and compacted by conventional earthmoving equipment.

5.50.1.2 Liners and barriers. Barriers and liners serve the same purpose—to prevent the migration (both lateral and vertical) of leachate water or decomposition gases. The suitability of the dredged material for this use is determined by the permeability of the material. Dredged material with a classification of CL or CH is likely to be suitable for use in constructing a liner or barrier. Attempts should be made to keep these barriers and liners saturated to prevent cracking and to keep pore spaces filled with water to prevent gas leaks.

5.50.1.3 Gas vents and leachate drains. Gas vents are used to direct the flow of gas to the atmosphere where it is harmlessly dissipated, and leachate drainage layers are used to intercept leachate and drain it to an area where it can be collected for treatment or recirculation (Bartos 1977a). The controlled ventilation of gas requires that the vent be more pervious than the surrounding soil, and a leachate drain must also be very pervious so that leachate drains quickly away from the solid waste. To be suitable for venting gas or draining leachate, the dredged material must consist of sand or gravel with little or no fines and must be much more pervious than the soils at the site.

#### 5.50.2 Site considerations.

5.50.2.1 Site selection. The selection of the solid waste placement site is the decision of the governing sanitary district, which evaluates both site suitability and site management options. The offer of dredged material to these districts allows them to consider sites initially screened out due to the lack of natural soil cover. It should be remembered that in this beneficial use, the USACE is simply providing a useful material to a sanitary district; therefore, site selection and construction and operation of the landfill are not the responsibility of the USACE.

5.50.2.2 Preliminary dredged material data collection. The dredged material source (dredging operation or containment area) should be defined in terms of location and quantity. Critical dredged material characteristics should be determined by examining physical characteristics, engineering characteristics, and settling properties and by noting any evidence of contaminants. The available dredged material should be viewed in terms of suitability for sanitary landfill use (for example, as covers, liners, barriers, vents, and drains). The dredging area should be assessed for available transport modes.

5.50.2.3 Transport systems. For dredged material uses in solid waste management to be economically attractive, the landfill site must be within a reasonable distance of the dredged material supply. Not more than 80 km (50 mi) is recommended in order to keep the unit cost of shipment down. Truck haul is the only mode of transport recommended because of its convenience, feasibility of operation, and ease of fitting into landfilling schemes (Landin 1980).

5.50.2.4 Economics. The success of any attempt to use dredged material in solid waste management depends on the economic feasibility of the project for each of the agencies concerned. Since each operation involving the use of dredged material in solid waste management is unique, economic feasibility is evaluated on a case-by-case basis. There should be a net benefit to all agencies involved.

#### 5.50.3 Experimental uses.

5.50.3.1 New York Fresh Kills landfill cover. The New York District experimented with using dewatered dredged material as landfill cover in a 3-year test. It found that while material could be dewatered and used successfully as cover, the primary problems encountered were that very small amounts of dredged material were utilized, and large land surface areas were needed as dewatering cells, making the cost per cubic yard of dredged material removed from the channel and used as landfill cover very expensive.

5.50.3.2 New Jersey realities. In 1997, the New York District and the U.S. Army Engineer Waterways Experiment Station (WES) discussed with Hackensack Meadows landfill operators the use of material if the USACE sent it to them already dewatered or mixed with other waste products, such as fly ash and other hard-to-dispose-of materials. Operators at that time considered taking the material if the USACE also paid tipping fees to the landfill operations, which made costs and feasibility very unrealistic.

5.50.3.3 Buffers. Discussions were held in 1997 with New York authorities about the use of barge-delivered dredged material to be placed in front of existing eroding and leaking landfill sites as buffers and erosion barriers. These would be made of dredged material, armored, and then backfilled with dredged material to intertidal elevations to serve as marshes to trap leakage and prevent further erosion of the landfills. This method appears to have merit, but is still in the earliest design and test phases; it could also be coupled with use of dewatered dredged material for capping in the same landfill site operations.

## Section XII

### Multipurpose Uses and Other Land Use Concepts

5.51 General. With careful engineering design, construction, long-term coordination and planning, and proper implementation of operational and maintenance procedures, a placement site having combinations of uses may be developed. Such multipurpose use is strongly encouraged. A park and recreational development built over an existing solid waste landfill using dredged material as a cap is an example of how several of the beneficial uses discussed in the preceding sections can be lumped into a single multipurpose project. There are a number of actual and planned examples of multipurpose sites. Often, multipurpose objectives do not involve substantial cost increases to the dredging project when plans are made in the initial phases of design and construction. Frequently, recreational use and wildlife and fish habitat can be developed simultaneously on a placement site. Potential problems with development of multipurpose projects are usually related to conflicting user groups of the proposed placement/development site. Careful selection of compatible potential users can avoid situations where the projected uses conflict.

## 5.52 Case Studies.

5.52.1 Aquatic Park. Aquatic Park in Toronto, Ontario, Canada, initiated in the 1970s and still being improved and enlarged, demonstrates what can be accomplished when poor-grade dredged material is placed in conjunction with higher-quality material to produce a multipurpose site. Along the shoreline, numerous commercial, transportation, and recreational sites have been created by the combined use of landfill and dredged material. Developed by the Toronto Harbour Commissioners, Aquatic Park is an excellent example of how the form of the land created can enhance the number and quality of productive uses. Construction rubble was used to build an approximately 5 km (3 mi) long headland running at an oblique angle to the natural shoreline. The headland was essentially linear, but it has numerous indentations in its shoreline dike. Dredged material was placed in the water behind the rubble dike where protection is afforded from wave and tidal action and associated erosion. The dredged material was placed to form contours for the development of lagoons and lakes along and behind the shoreline. The resultant configuration of the headland resembles natural landforms in the area. The length of shoreline is many times the length that would have resulted from a conventionally shaped placement area; thus, opportunity for shoreline utilization has been increased. Figure 5-55 shows Aquatic Park during dredged material placement in early stages of development. This site has been improved by the additions of a small airport, and as new material is added, new parkland, recreational fields, and other amenities.

### 5.52.2 Pointe Mouillee.

5.52.2.1 Another very interesting and highly successful case study is Pointe Mouillee in western Lake Erie, MI (Landin 1982, 1993; Landin, Webb, and Knutson 1989) (Figure 5-56). Pointe Mouillee has been under development by the Detroit District for over 25 years. All engineering operations on the island portion and dikes were completed in 1983. The marsh phase of site development, including construction of freshwater marshes, marinas, visitor center, public walks and areas, and fishing facilities, began in the early 1980s. The existing marsh inside the installed floodgates is progressing naturally, nourished by sediments trapped by channeling part of the Rouge and Detroit Rivers through the marsh. Since the invasion of exotic zebra mussels into Lake Erie, the State of Michigan is managing the marsh and shallow water cells with water drawdowns (closing the culvert gates to do so). This also allows them to manage the high carp levels that accumulate inside the cells. The nesting islands built of dredged material are covered with tall vegetation, and the fringes are being used by nesting waterfowl. Portions of the shoreline have been planted in grain fields for wildlife. Three of the barrier island dike compartments are filled to capacity with dredged material, but as the material consolidates, they could receive additions of new material. In the meantime, they are colonizing naturally with locally occurring plant species.

5.52.2.2 The island is scheduled to be planted with perennial grasses and forbs to create upland and wetland nesting and grazing meadows. Capping the dredged material with clean soil was considered in the long-range management plan, but this will probably not be necessary due to the lack of contaminants within the root zones of plants (Landin 1982, 1993; Landin, Webb, and Knutson 1989). The dikes of the island have been used by waterbirds, primarily gull species, for loafing and feeding since construction began. There are now two heronries on the island, with

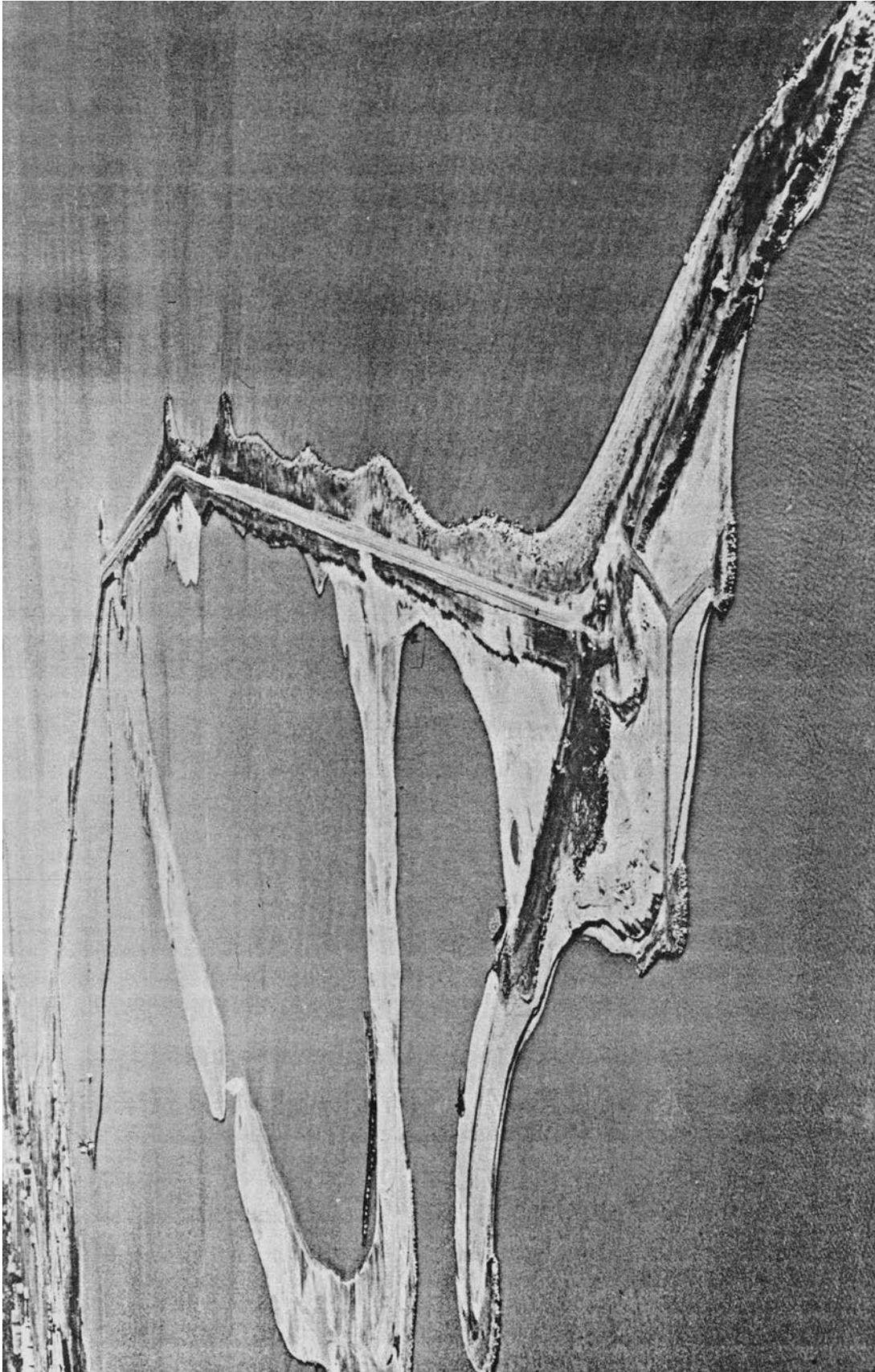

Figure 5-55. Dredged Material Placement at Aquatic Park, Toronto, Ontario, Canada, in the 1970s; This Site Continues to be Developed as a Recreational and Commercial Area, and it is Heavily Utilized by Citizens and Visitors



Figure 5-56. Pointe Mouillee, a 1,900 ha CPF for Contaminated Credged Material in Western Lake Erie, also Serves as a Multipurpose Beneficial Use Site

room for expansion of this use. This follows the expected pattern for construction in Lake Erie, noted in the 1970s, in which virtually every new dredged material site was colonized by nesting seabirds if the site consisted of suitable habitat (Soots and Landin 1978). A management plan for the site was drafted in 1980-81 and is being followed carefully. This site is one of the few dredged material projects in which a USACE District has applied for and received permission to use Section 150 funds of the Water Resources Development Act (Public Law 94-587) for wetlands development, and up to \$400,000 per dredging project has been earmarked for habitat development of Pointe Mouillee (Newling and Landin 1985, Landin 1993). This site is multipurpose, providing wetlands, upland, island, and aquatic habitat development; fishing, hunting, and boating recreation; ice fishing; nature trails; marina; visitor center; bird watching; and jogging and hiking.

5.52.3 Batiquitos Lagoon. A third example of a multipurpose site is Batiquitos Lagoon at Carlsbad, CA (Figure 5-57). This site took almost 25 years from initial concept through planning, permits, design, and construction, and it will be monitored for 20-30 years to determine its long-range success (Appy 1990; Sales and Appy 1994). Batiquitos Lagoon has many state-of-the-science aspects; it is the off-site, out-of-kind mitigation site for the Ports of Los Angeles and Long Beach for their port expansion projects. Port expansion was tied to mitigation completion, and the mitigation project was tied up in state permit requirements and lawsuits by environmental groups for well over 10 years. It is a well-conceived, -designed, and -constructed restoration of a degraded, silted-in, odor-causing saltwater lagoon that struggled to have access to the Pacific



Ocean due to development along the shorelines, vehicle roads, I-5, a rail line, and inadequate bridge openings that blocked flushing. In addition, the beach consisted of large cobbles, which would fill in an opening to the lagoon provided by dozer within a matter of days. The lagoon was dredged to provide material with which to build nesting islands for endangered California least terns. The material was also used in other ways. The entire lagoon was deepened and contoured to provide deep water areas during low tides, shallow water areas that became sand flats at low tide, low-zone emergent (Pacific cordgrass) and high-zone saltmarsh (glasswort species). More importantly, an opening was designed and one bridge rebuilt to provide a stable opening to the lagoon so that tidal flushing could occur on a daily basis. Even in its early restoration stages, the lagoon is providing abundant habitat for finfish, shellfish, sea birds, wading birds, waterfowl, and humans although human use is discouraged except along the beach until the project is completed and vegetation established. Batiquitos Lagoon is viewed as a modern solution to port expansion in California urban areas while dealing with environmental responsibilities and regulations.



Figure 5-57. Batiquitos Lagoon at Carlsbad, CA, in 1977, a Restored Lagoon Using Dredged Material that was the Mitigation Site for Expansion of the Ports of Los Angeles and Long Beach

5.52.4 Dredged material deposits and restorations at Portland, OR. Many beneficial uses are being made of dredged material on both shorelines of the Willamette and Columbia Rivers in Portland, OR. Several hundred hectares of placement sites have become the ultimate in multiple uses, including the following:

31 Jul 15

- a. Port and harbor expansions (Figure 5-58).
- b. Multiple industrial companies and businesses (several hundred).
- c. Two commercial shopping centers.
- d. A complex of private homes and another of condominium townhouses.
- e. A Red Lion Inn hotel on each bank of the river.
- f. Apartments.
- g. Open space and parks.
- h. The Portland International Airport.

5.52.5 Other examples. A fifth example of a multipurpose placement site is being developed in Coos Bay, OR, where a large containment site with eight compartments and extensive cross dikes is being filled and dewatered incrementally. The site will ultimately be developed for port, industrial, residential, and urban uses by the local sponsor, and parts of the site are scheduled for agricultural crops. Some of the beneficial uses examples given in other chapters of this EM that have actual multipurpose use include Riverlands at St. Louis, MO (Figure 5-59); Weaver Bottoms in the Upper Mississippi River (Figure 5-60); Kenilworth Marsh in Washington, DC (Figure 5-61); Eastern Neck National Wildlife Refuge (Figure 5-62); Aransas National Wildlife Refuge (Figure 5-63); Mission Bay in San Diego, CA; Hart-Miller Island in the Chesapeake Bay (Figure 5-64); Gaillard Island in Mobile Bay, AL; the aquaculture project at Freeport, TX; most of the examples included in other sections; and a number of island and shoreline habitat development sites where recreation and boating are also prime uses.

5.53 Other Land Use Concepts. Dredged material beneficial uses described and discussed in this EM are all highly productive, environmentally and economically acceptable alternatives to standard placement practices. Dredged material has been shown in numerous cases to be a valuable resource with comparable properties of any saturated (or dewatered) soil. A few uses that may be considered beneficial did not merit separate chapters, but will be discussed here for completeness of this manual.

5.53.1 Erosion gully fill. Large quantities of dredged material could be placed within the numerous gullies formed from poor soil conservation practices in both rural agricultural and urban construction areas. Such gullies are unsightly and unproductive, and generally, attempts to cover them with vegetation such as kudzu, rather than to reclaim them, are made. Since few of these hill sites occur within reach of hydraulically pumped material, only dewatered and transported material could be used. However, transport and handling costs would make this an expensive alternative that probably will find little, if any, economically feasible justification. Several hundred hectares of upland gullies were filled and restored to productive grazing and farmland in the Tennessee-Tombigbee Waterway system along the Divide Cut in northeast Mississippi by the Mobile and Nashville Districts during the construction of the waterway. These have remained stable and productive for the past 18 years.



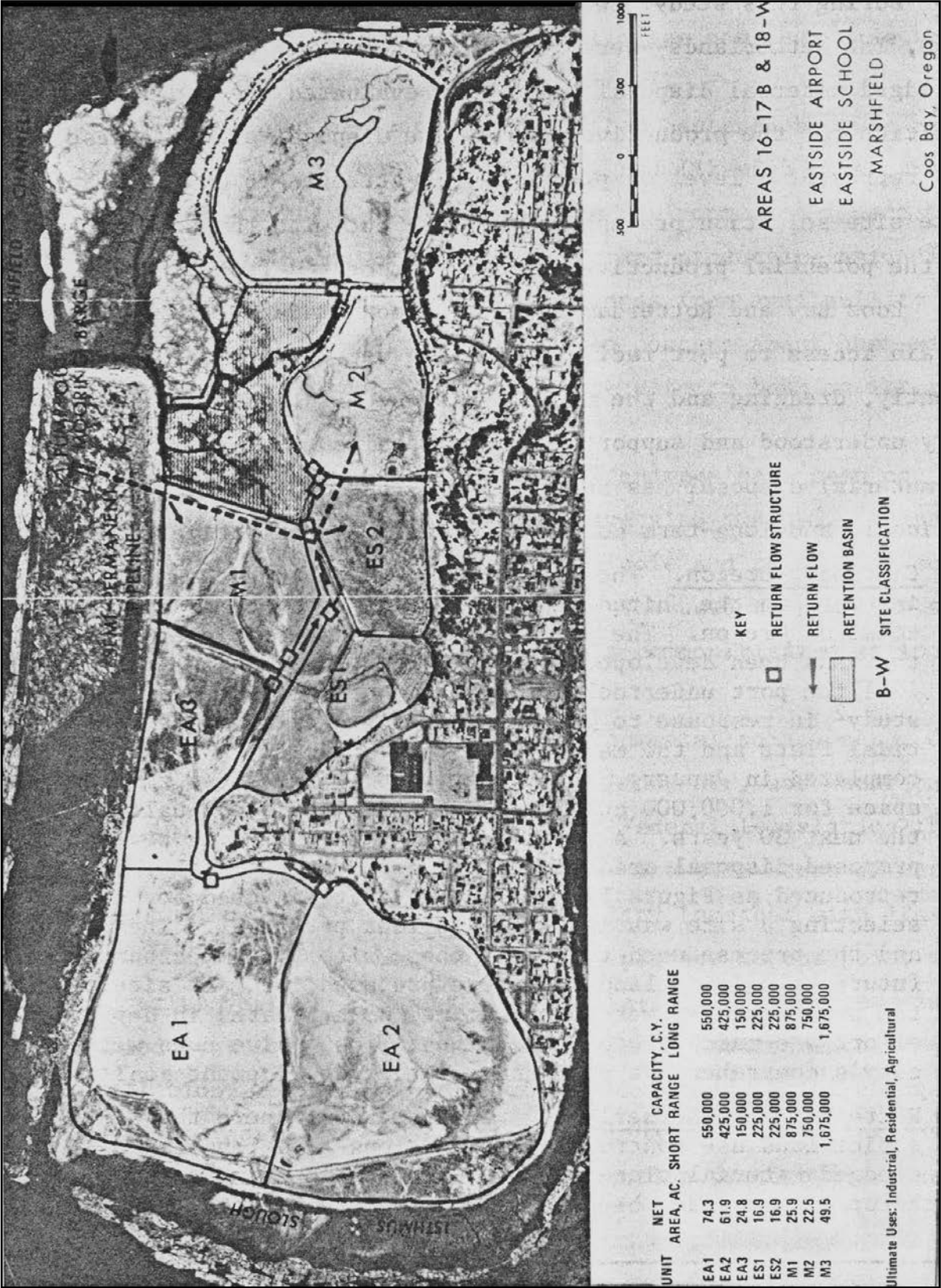

Figure 5-58. Coos Bay, OR, Placement Areas that are Being Used for Industrial, Residential, and Agricultural Purposes



Figure 5-59. Riverlands Wet Prairie and Bottomland Hardwood Restoration Site Using Dredged Material and Innovative Restoration Technology, St. Louis Area on the Illinois/Missouri/Upper Mississippi River Junctures, in 1993

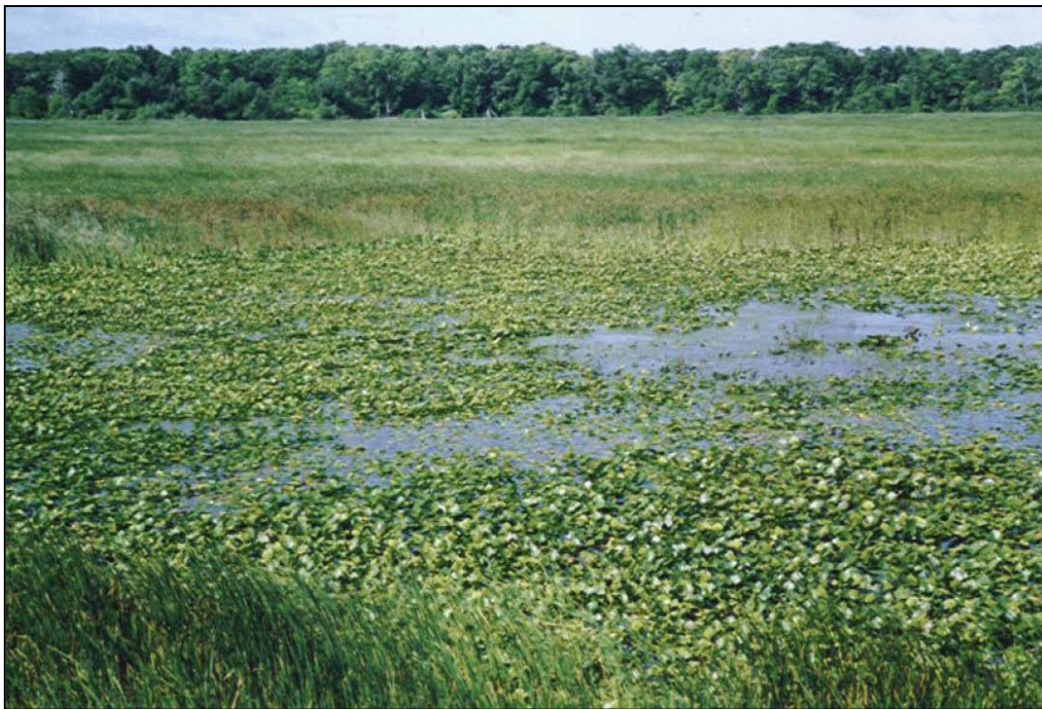

Figure 5-60. Weaver Bottoms Dredged Material Wetland Restoration Project, Upper Mississippi River, MN





a. Geotextile Water-Filled Tubes Being Used as a Temporary Dam to Contain Dredged Material until it had Sufficiently Dewatered so that Marsh Planting Could Take Place at Kenilworth Marsh on the Anacostia River, Washington, DC, in 1993; the Tubes were Removed once the Material had Consolidated, and the Site was Planted



b. Planting the Kenilworth Marsh Dredged Material Wetland in May 1993

Figure 5-61. Kenilworth Marsh, Washington, DC (continued)



c. Kenilworth Marsh in 1998

Figure 5-61. (concluded)

5.53.2 Topography relief. Another means of using large quantities of dredged material is building hills for landscape diversity on large, level recreational sites. While this would also usually apply only to dewatered material and would be costly, it has been considered in planning by the Fort Worth District in the special case of new-work dredging in the Trinity River due to the huge quantities of material to be moved, and it has been field tested in the Detroit District by the City of Toledo, OH, in dealing with full placement sites in Lake Erie. It is also being practiced in modification in the Red River Navigation Project in Louisiana, where new cut work is being used to raise the elevation of island sites, for recreation purposes, in the river to a level higher than the floodplain. These Red River sites employ hydraulically deposited material while the other two employ dewatered material.

5.53.3 Earthen or earth-filled dams. In areas where reservoirs for flood control, recreation, or other purposes are planned, dewatered dredged material could be transported and used for construction of either earthen or earth-filled dams. This alternative would be feasible only in locales where other sources of borrow material are more costly or unavailable.

5.53.4 Institutional use. Institutional use includes all public service/municipal uses of dredged material containment areas, including electric utilities, transportation systems, water and wastewater facilities, and other buildings.





a. Construction of the Riprap and Dredged Material Detached Breakwaters to Break Wind Fetch and Wave Energy, Approximately 125 m (400 ft) Offshore in Shallow Water at Eastern Neck National Wildlife Refuge



b. Eastern Neck National Wildlife Refuge, Constructed of Dredged Material, at 2 Years Old in 1995

Figure 5-62. Eastern Neck National Wildlife Refuge, Chesapeake Bay, MD



a. Saltmarsh Restoration Using Dredged Material and Bioengineering Structures at Aransas National Wildlife Refuge in 1994; the Site is less than 6 Months Old in the Photograph



b. Dredged Material-Filled Geotextile Tubes Fronting the Planted Saltmarsh at Aransas National Wildlife Refuge

Figure 5-63. Aransas National Wildlife Refuge, Freeport, TX





a. An Aerial View of the North and South Cells of Hart-Miller Island, which Consists of 445 ha of Dredged Material and which will be a Recreation/Wildlife Habitat Site when it is Completed; Note the Dewatering Trenching Lines in both Cells



b. Trenching the North Cell of Dredged Material on Hart-Miller Island to Maximize Dewatering, so the Site can be Filled to Capacity prior to Wildlife Habitat Development

Figure 5-64. Hart-Miller Island, Chesapeake Bay, MD

31 Jul 15

5.53.4.1 Pleasure Island, TX. One case study is Pleasure Island, bordering the Intracoastal Waterway near Port Arthur, TX, a 1,400 ha land area formed from over 50 years of silt and sand placement. A rock dike protects the small, developed portion of the island. Among the diverse facilities in this area of the island are a university campus (Lamar University), an Army Reserve Training Center, and a USACE Area Office. Two recently constructed rock dikes will encourage further institutional facilities, including an already planned sewage treatment plant.

5.53.4.2 Pelican Island, TX. A second example in Texas is the Pelican Island complex at Galveston, TX, where dredged material has been used for many years to both expand a natural island and to connect it to the mainland. The site now holds, in addition to two intertidal wetlands constructed of dredged material, Texas A&M University-Galveston, the National Marine Fisheries Service Galveston research laboratory, a state park, a public museum, and other public facilities. It also contains a number of industrial sites and complexes, and in the ongoing dredged material placement areas on the island, there are an estimated 5,000 pairs of seabirds nesting on the island each year.

5.53.4.3 Delmarva nuclear power plant. Another example is in Salem County, NJ, where a 1967 land exchange negotiated between the USACE and the local public utility company has resulted in the construction of a nuclear power plant on an 80 ha placement site. The first of four units commenced operation in 1976; the remaining units were online by 1979 and 1980. The site was originally a sandbar upon which fine-grained material from Delaware River dredging over the past 70 years had been placed to form a peninsula; it is now called Artificial Island. Adjacent to it in midchannel is a large natural island called Pea Patch Island, on which dredged material has been placed for many years and which has been the home of the only heronry in that reach of the Delaware River system for over 40 years.

## Section XIII

### Construction and Industrial/Commercial Uses

#### 5.54 Harbor and Port Facilities.

5.54.1 The economic potential and social productivity of industrial/commercial activities provide a strong incentive for urban growth and development. These activities have flourished in natural harbors and along urban waterways where raw materials can be received and finished products shipped most economically. Industrial/commercial development near waterways has been aided by the availability of hydraulic fill material from nearby dredging activities. The use of dredged material to expand or enhance port-related facilities has generally received local support because of the readily apparent potential benefits to the local economy. Approval of the placement operation is generally predicated on the advancement of the port development project and not on the incidental need for proper placement of the dredged sediments. Traditionally, where placement has been to advance the industrial development goal, attempts were made to use the dredged material beneficially; where it would not, the material was placed by the most economical means available. The key for the beneficial use planner is to identify how, when, and where dredged material from a navigation project can fulfill an economic need while not overlooking biological beneficial uses and environmental considerations and limitations.



Identification of economic or social benefits may help overcome some environmental opposition to placement sites. Job-producing planned uses in cities with depressed employment are much more likely to gain approval than projects that appear to conflict with basic community needs.

5.54.2 There are numerous examples of dredged material sites that were used in harbor/port development, such as that already noted for the Port of Portland. One such facility constructed on dredged material is the Presidents Island-Memphis Harbor Project, located approximately 8 km (5 mi) southwest of Memphis, TN (Figure 5-65). This 384 ha site on the southeast side of the island (now a peninsula) is filled with sandy dredged material. A slack-water area was created by diking, a 246 m (807 ft) wide by 4 m (13 ft) deep channel was dredged, and the sediments placed along 6 km (3.7 mi) of the channel north bank. Filling was completed in 1957, and within 20 years most industrial development was completed. By 1973 over 70 separate industrial concerns had bought or leased acreage on the site. A feasibility study of proposed harbor expansion alternatives prepared by the Memphis District recommended that a second harbor channel be dredged at Presidents Island and the material placed on the island along the new channel's south bank. This proposal created an additional 400 ha above the floodplain for port and related industrial/commercial facilities. When the first facility was completed, there was little concern for the wetlands that were covered up. Expansion plans must take these wetlands into careful consideration. A large bottomland hardwood area owned by the port is being used as a mitigation bank as they develop port facilities.

5.54.3 In dozens of locations in U.S. rivers, dredged material is used for such benefits and for creating foundation above the floodplain for grain elevators, shipping terminals of all types, barge-fleeting areas, and storage facilities for U.S. products waiting to be moved to market (coal, timber, agricultural products). Two examples at Portland, OR, a container facility and a grain elevator located at convenient shipping points, were both built on dredged material (Figure 5-66). The Port of Portland has continued to expand its facilities, primarily on dredged material placement sites. Another example is the harbor at Vicksburg, MS, on the lower Mississippi. A large industrial site providing facilities to over 60 industries was built on dredged material from the Yazoo River (Figure 5-67). Other examples include port and shipping facilities at Texas City, Galveston, and Houston, TX, in Galveston Bay; port facilities in the Duwamish River in Seattle, WA; facilities at Blakely and Brookley Island complexes in upper Mobile Bay, AL; port expansion at Los Angeles and Long Beach, CA; and Navy homeporting sites in Mobile and Everett Harbor.

5.55 Residential and Urban Use. In spite of the sometimes poor foundation qualities, dredged material containment areas have become sites of multiple-building, high- and low-rise residential and business complexes. Success has been attained where the properties of the dredged material have been properly accounted for in the residential design. A few examples of residences and businesses built on dredged material include the following:

- a. Almost the entire City of Galveston, TX, where dredged material has been used for fill, erosion control, hurricane protection, foundation material, and other beneficial uses for at least the past 85 years.

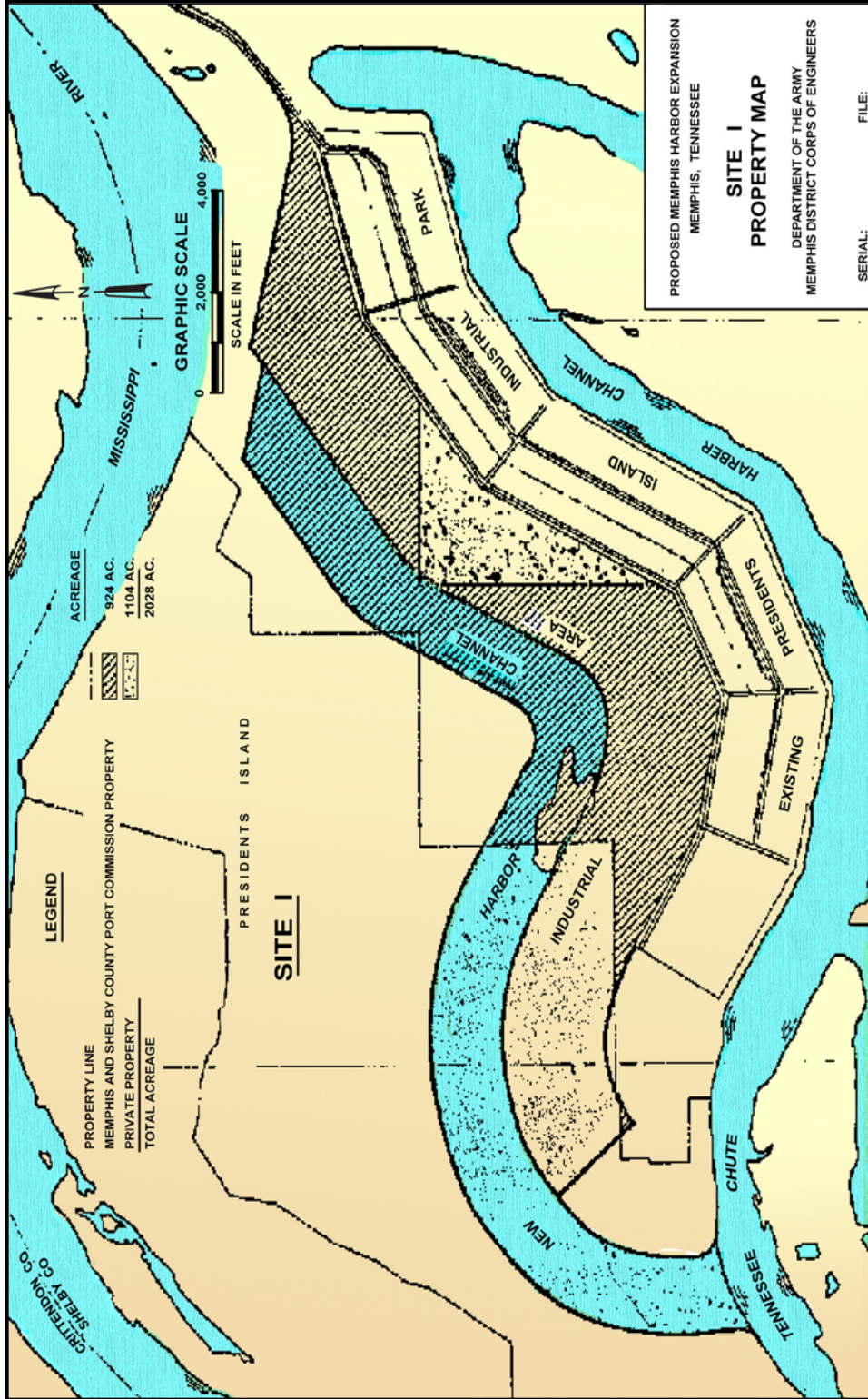

Figure 5-65. Presidents Island-Memphis Harbor Project; this Project has Developed According to the Port of Memphis Master Plan over the Past 25 Years

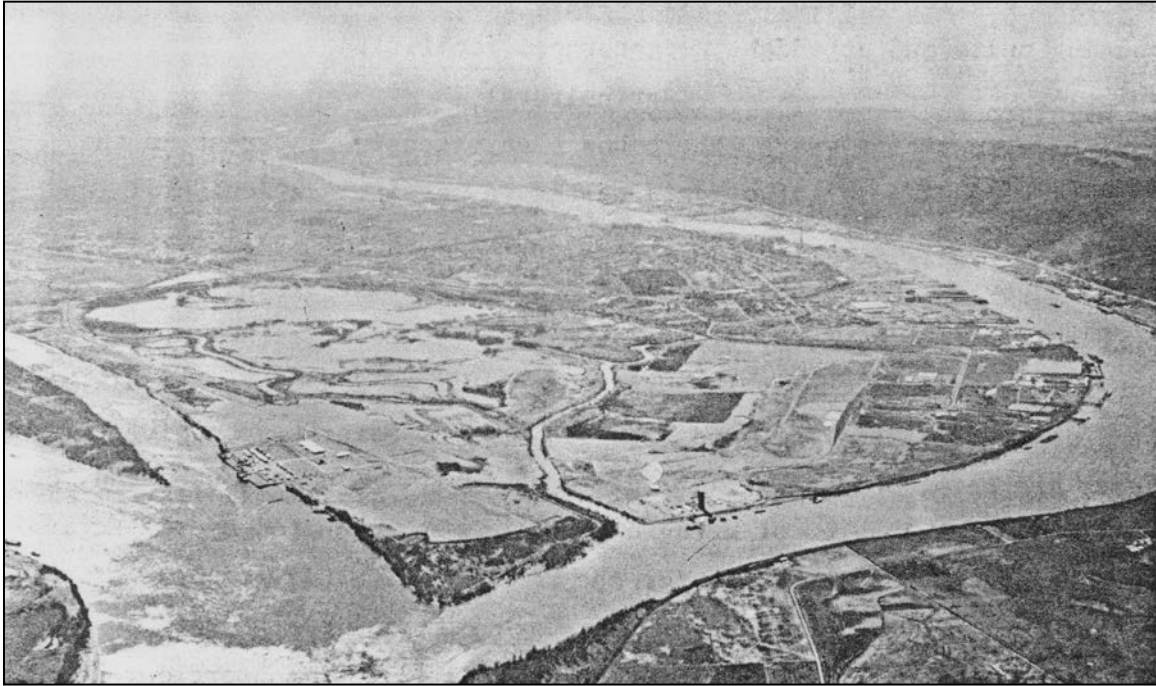

Figure 5-66. Two Port Facilities—a Container Port Located on the Columbia (left) and a Grain Terminal Located on the Willamette (right)—were Built on Dredged Material at the Confluence of the Two Rivers in Portland, OR, in the 1970s



Figure 5-67. The Port of Vicksburg, MS, Constructed on Dredged Material over 50 Years ago, is a Thriving International Port of Entry on the Lower Mississippi River

31 Jul 15

b. Thousands of residences and businesses built on sandy dredged material in Tampa, St. Petersburg, Clearwater, Sarasota, Miami, Jacksonville, and numerous other locations in Florida. (Most of these were built in wetlands and, therefore, this type of development in Florida has decreased significantly in the past 10 years.)

c. Residential areas in the Borough of Bronx and shorelines of the East and Hudson Rivers in New York City, NY.

d. Residential and business areas throughout the city of New Orleans, LA, both on the riverfront and on Lake Pontchartrain.

e. A combined use of sandy dredged material over the past 75 years on the Mississippi Gulf Coast for residences and businesses, highway fill, seawall protection, and beach nourishment (for both recreation and nesting habitat for the coastal least tern).

f. Businesses at Jackson, MS, including the large Herrin-Gear Complex vehicle dealership, where borrow material was dredged from inside the Pearl River levee and pumped into place outside the levee for foundation material.

g. A huge industrial/residential/commercial complex, including a marine park, built on sandy dredged material at San Diego, CA (Figure 5-68).

h. A large shopping center complex built on dredged material at Swan Island on the Columbia River in Portland, OR. It includes shopping and commercial areas and low-rise office buildings (Figure 5-69). This busy tourist and shopping area remains in use more than 30 years later.

i. Historically, parts of the old town sections of New York along the East and Hudson Rivers waterfronts, Baltimore Inner Harbor, Philadelphia waterfront, Washington, DC, Charleston waterfront, Savannah waterfront, Jacksonville waterfront, and numerous other U.S. cities along major rivers and in major harbors. Even prior to the American Revolution, hand- and oxen-pulled slips (crude dredges) were used to remove sediment from bottoms to deepen waterways and raise the level of the adjacent bank. The Jefferson Memorial and other historical landmarks are on dredged material fill in Washington, DC.

5.56 Airports. Airport runways and facilities in New York City, NY; Washington, DC; Grays Harbor, WA; Minneapolis, MN; New Orleans, LA; Portland, OR; San Francisco, CA; Brookley Air Force Base in Mobile, AL; and a number of other coastal areas have been built on dredged material foundations in areas where insufficient land was available for a commercial airport, and use of dredged material was easily justified both economically and socially. Such uses of dredged material will undoubtedly continue as harbors and cities increase in congestion and population, but they will require mitigation of environmental impacts.



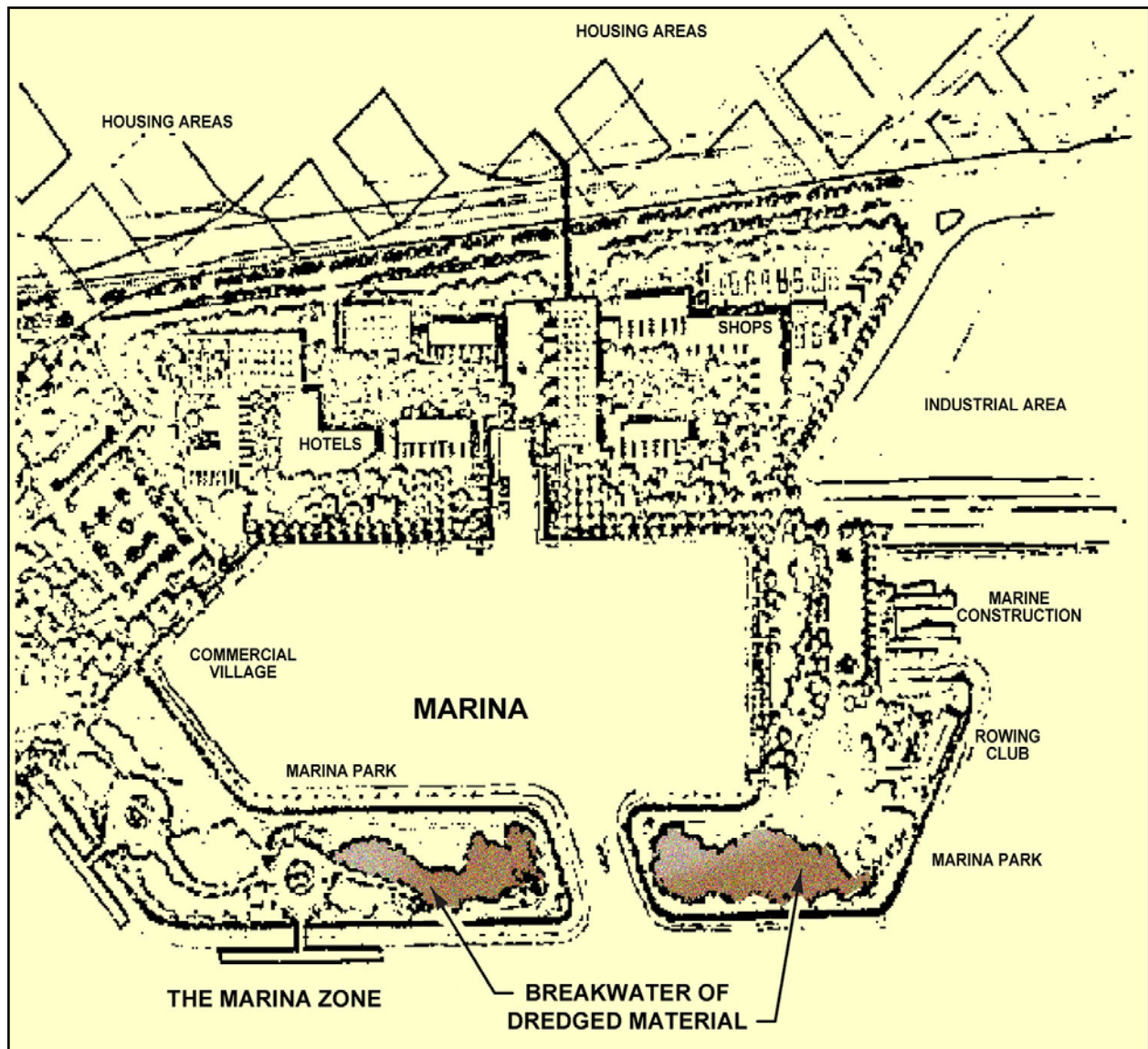

Figure 5-68. The Master Plan Used for Construction on Sandy Dredged Material of an Industrial/Residential/Commercial Complex, Including a Marine and Amusement Park and Sea Grass Restoration Projects, at Mission Bay, San Diego, CA

5.57 Dikes, Levees, and Containment Facilities. The USACE makes almost constant use of dredged material for dikes, levees, and confined placement facilities (CPFs). Dredged material, pumped onsite and dewatered, readily lends itself to these uses. By using dredged material to build or increase capacity in CPFs, or for dikes and levees, overall project costs can be reduced while not having to use fastland soil for these projects and by expanding the life of existing containment sites. Some local and state agency and private use is made of dredged material for dikes and levees in certain situations such as for erosion and flood protection or for private industrial dredged material containment facilities.

31 Jul 15



Figure 5-69. A Large Shopping Mall, Port Center, which was Built on Dredged Material at Swan Island on the Columbia River at Portland, OR, Includes Shopping and Commercial Areas as well as Low-Rise Office Buildings

5.58 Fill Material and Roads. Thousands of cubic yards of dredged material have been dewatered in holding areas, then given or sold to public or private interests for fill material. This material has been used for a variety of building and parking lot foundation and site capping uses, primarily in urban areas. It has also been used for road construction as foundation material, especially in coastal counties. Often, such material is given away without charge in order to make room in placement sites for subsequent placement. In the St. Paul District, dewatered sandy material was used to fill in an abandoned gravel quarry that was a dangerous eyesore. These beneficial uses, coupled with minimal handling requirements, make these placement alternatives inexpensive and attractive. Minnesota Department of Transportation has also used sand dredged material as highway fill and in lieu of road salt.

5.59 Islands and Historic Preservation. On the Mississippi, Louisiana, Alabama, and Florida Coasts, historic sites on barrier islands and beaches have been protected from wave erosion and subsidence by sandy dredged material being pumped around and near such sites. Excellent examples are found in Mississippi where the beachfront, with its historic colonial and antebellum landmarks, and Ship Island, where historic Fort Massachusetts is located, were restored with sandy dredged material after both were almost totally demolished by Hurricane Camille in 1969. More recent hurricanes have also had an impact, and each time the coastal counties, the State of Mississippi, and the USACE restore the historic properties and beaches with sand dredged

material. These sand islands and beachfronts also help to preserve historic landmarks on the mainland from a direct assault by storms and hurricanes. Clean dredged material can also be used as caps for archaeological sites along U.S. rivers and lakes, preserving them from erosion, theft, and vandalism until such time as funds and time can be found for scientific study and evaluation/restoration.

#### 5.60 Considerations.

5.60.1 Once material has been placed inside a containment facility and dewatered, the use of dredged material as industrial/commercial and construction material requires almost no additional work on the part of project engineers unless it involves a USACE work project,. Users and sponsors of the dredged material site at that point are responsible for movement and handling of the material, development of the site, management and maintenance, and all other aspects of industrial/commercial site use. If the dewatered material is to be used for dike and levee construction, normal earthmoving and handling procedures by the USACE apply and, generally, do not involve use of a dredge. Techniques outlined in Eckert, Giles, and Smith (1978); Hammer and Blackburn (1977); Palermo, Montgomery, and Poindexter (1978); and Walski and Schroeder (1978) are referenced for dike and CPF engineering design and construction. Van't Hoff and Nooy van der Kolff (editors) (2012) present detailed information on the planning, design, and construction of land reclamation using hydraulic fill. This reference's objective is to achieve optimum design based on the available quality and quantity of fill material, site-specific conditions, dredging equipment and related construction methods, and appropriate functional and performance requirements. Industrial/ commercial use of dredged material is probably one of the most inexpensive beneficial uses. Its primary advantage, other than low cost, is that it allows greater use of placement sites when dredged material is removed. Its primary disadvantage is that on sites that become industrial areas, port facilities, airports, and other such commercial ventures, the sites are no longer available for placement, and other placement sites must be located and obtained.

5.60.2 Since 1996 clay dredged material has been tested by the brick industry to determine if it is feasible and cost-effective for manufacture of bricks for home and commercial uses. Tests indicate that it is, and brick examples have been manufactured and field tested in Georgia and other states.

5.60.3 While there are a number of obvious economic advantages to these types of beneficial uses, the environmental aspects may be so disadvantageous that a project is not feasible. For example, most of these sites already built displaced wetlands and other critical habitats. This can no longer be done without mitigation and stringent permit requirements.

## Section XIV

### Baseline and Monitoring Studies

#### 5.61 General.

5.61.1 Potential beneficial uses of dredged material should be thoroughly examined as part of preproject planning studies. Preliminary surveys of existing and candidate sites should be made during the reconnaissance phase of new studies, and detailed aerial and ground surveillance should be conducted for feasibility studies. Results should be displayed in the appropriate format in feasibility reports, including preauthorization survey reports. Project environmental assessments and environmental impact statements must include a detailed comparison of alternative sites, including adverse and beneficial impacts (Landin 1992b).

5.61.2 Modern tools such as remote sensing, visual data management systems, and automatic data processing should be employed to help determine the most appropriate locations and best uses for dredged material. High-resolution aircraft-collected scanner imagery and color infrared photography can provide detailed land-use information that can be directly analyzed by computer. Information obtained through remote sensing not only provides a valuable database, but it can be used to monitor changes in existing conditions with or without the project. A variety of computer systems and software programs are available for analyzing data.

5.61.3 Coordination with other Federal and state agencies is essential for projects that include dredging activities. Scoping meetings should be held at regular intervals throughout all phases of project planning. Agencies and organizations that should be involved in scoping activities include the USEPA, FWS, National Marine Fisheries Service (when operating in coastal waters), state coastal zone management agencies, state fish and wildlife agencies, and state and Federal cultural resource agencies. Other state and local organizations, both public and private, should be included as appropriate. Adequate review time must be provided for agencies to comment on proposed actions (Landin, Hayes, and Payne 1997).

#### 5.62 Monitoring.

5.62.1 Background. This paragraph describes the needs, considerations, and some methods for monitoring dredged material operations prior to, during, and after dredging in order to have a clear picture of the dredging and beneficial use impacts and values as well as a source of pertinent references on monitoring. In this paragraph, monitoring focuses on only those beneficial uses of dredged material that are derived from vegetation and/or animals. It is important that managers of dredging projects and/or placement sites have a good understanding of what to monitor, why it is important to monitor, where monitoring should be conducted, when monitoring should occur, and how it should be carried out for the most efficient data collection and cost savings (Landin 1992b).

5.62.2 Need for monitoring. Monitoring of a proposed or existing dredged material site for the purpose of planning appropriate beneficial uses is an absolute necessity to ensure compatibility between or among the proposed uses and the dredged material placement activities. Monitoring is important for numerous reasons. It provides a framework or database from which



logical beneficial use alternatives can be proposed. For example, if waterfowl habitat is desired for hunting use, but monitoring data indicate that marsh cannot be established because of too much wave energy, it makes little sense to consider duck hunting as a beneficial use. Monitoring also documents that appropriate planning of dredged material uses has been implemented and provides a basis from which defensible arguments can be made for selected beneficial uses. Monitoring is useful in obtaining an understanding of potential problems with alternative uses of dredged material, constraints, or possibilities related to dredged material management. It provides a clear picture over time whether the planned beneficial uses develop properly or at all and what changes are taking place that influence those uses or other potential beneficial uses. For example, Miller Sands Island, planted as an upland goose resting/grazing pasture in the Columbia River, has reverted to use primarily by nutria because the sandy pasture has not been maintained by soil amendments and by trapping of the nutria, which eat the good grasses and herbs planted for goose pasture and leave only horsetail, an unpalatable plant. A monitoring program can indicate if these kinds of situations are developing, so remedial actions can be taken to preserve the intended beneficial use (Landin 1992a).

5.62.3 Considerations of monitoring. In planning and initiating a monitoring program of beneficial uses on dredged material, one must consider a variety of factors that are likely to impinge upon both dredging operations and the intended beneficial uses (Landin 1992a; Thom and Wellman 1996). These impingements may take place prior to, during, or after dredging and can influence decisions as to what beneficial uses should be planned and how they are likely to change over time. The level of attention needed will be greatest in the initial stages (that is, monitoring the placement process, overseeing propagule collection and planting, and so on) and will, in most cases, decrease with time. Influencing factors that should be monitored include such things as soil or substrate conditions, size and location of site, plants and animals presently on the site or in nearby areas, natural succession typical of the area, existing and future site use, flooding and/or wave energy conditions, tidal conditions, social and economic considerations, and the probability of future dredged material deposition. This paragraph suggests a general monitoring approach to follow after the decision has been made to develop selected beneficial uses on a site. It assumes that legal restrictions, site availability, site capacity, and other legal, administrative, or engineering aspects are favorable.

5.62.4 Methods. Beneficial use monitoring may be planned for two kinds of sites: an established dredged material site where deposition has been completed, and a site where proposed or ongoing deposition of dredged material is taking place. In the first case, an established dredged material site may be many years old or relatively new, and it may be vegetated or unvegetated. In the second case, the new substrate at any one or more topographic elevations dictate whether the site will be aquatic or upland or a combination of the two. The approach should be tailored to the kind of deposition. Monitoring of a site involves numerous factors and therefore can be most effectively accomplished by a multidisciplinary team, generally including a wildlife biologist, botanist, soil scientist, engineer, fisheries biologist, land use planner and, in some cases, a lawyer. The team needs to be structured according to the anticipated uses of the site. For example, it makes little sense to include a fisheries biologist if an upland site without any ponds or lakes is the site being considered for beneficial uses unless ponds or lakes are anticipated. Four steps for each item to be monitored should be followed: develop a statement of

objectives, identify the population or unit to be sampled and data to be collected, specify the precision of data collection, and select an efficient sampling design.

5.62.4.1 Physical factors. Physical factors considered important to monitor include such things as climate; geographic location and size; topography and configuration; physical and chemical characteristics of the substrate to be deposited upon and material to be deposited; tides, currents, and other hydrological data; physical and chemical characteristics of the water in which material is deposited; and land use.

a. Climate. Climatic data are important to monitor because they dictate what kinds of plants and animals can ultimately grow and reproduce at the site. In a dredged material placement project it is usually impractical to collect climatic data personally over a long enough time period for it to be meaningful. Therefore, the planner should resort to the literature and data sources that apply to the site area. First, the climate should be evaluated on a large scale because climate changes are relatively slow. Changes in such things as soils and vegetation usually occur gradually. Soil and plant communities are relatively stable and mutually compatible over extensive land areas. Classification of climates over large areas requires development of parameters such as temperature and rainfall extremes on a macroscale. Maps available from the U.S. Department of Commerce enable determination of approximate limits of average minimum temperatures, rainfall distribution zones, major climatic zones, and other zones that influence types of vegetation that can be grown in an area. Then climatic conditions should be determined on a microclimatic scale, or those climates within the first few feet of the soil. It is important to characterize these because they determine more accurately whether plants and animals will be able to survive drought, chilling, frosts, or excess moisture. Those microclimates characterized by low precipitation during the growing season will have a deficit of moisture for plant growth, especially if temperatures are high. For example, St. Paul, MN, is in a semihumid grassland-forest transition zone because it has a mean annual precipitation of 62.5 cm (24.6 in.). However, San Antonio, TX, with the same mean annual precipitation, has semiarid vegetation because of higher temperatures—21° C (70° F) versus 7° C (45° F). Soil-water losses are greater in Texas than in Minnesota. To obtain these temperature and rainfall data at a local level, the planner should refer to local meteorological data furnished by the nearest National Weather Service station or establish an onsite weather station obtainable from scientific instrument supply distributors. If the latter option is selected, data should be collected in the area for as long as considered practical, preferably for at least 2-3 years.

b. Geographic location and size. Geographic location will determine any macroclimate and microclimatic characteristics, which will in turn influence plants and animals. The potential or existing size of a placement area should be considered in relation to its location; these interrelated factors determine the potential value of an area for various beneficial uses. This is particularly true for the development of wildlife habitat. Small areas may offer no appreciable habitat development potential whereas large areas may offer numerous management possibilities. Location of the site is extremely important, perhaps much more so than the size. Coastal Zone Resources Corporation (1976) relates an example that illustrates this. An 0.8 ha upland site surrounded by marsh and located very close to the mainland may support a greater diversity of wildlife species than a 4 ha island site with similar habitat but isolated from marsh and mainland populations by open water. The smaller site may often be used by marsh inhabitants such as rails, herons, egrets, and raccoons;

it may be visited by white-tailed deer and many small land birds; and it may support a high marsh rabbit population due mainly to the abundance of surrounding marsh vegetation. Natural plant succession and dispersal of animal species occur quickly and easily due to the proximity of the area to plant and animal sources. The island site, although larger, may be used only by waterbird species. Natural succession and animal dispersal to the island are slower due to the isolation of the island. Often dredged material islands are the only areas available for bird colonies, and the isolation keeps predators and human disturbance to a minimum.

c. Topography, configuration, and land features. The topography and configuration of a site must be examined because these factors greatly influence potential beneficial uses. The elevation of the dredged material in relation to mean water level will determine, for example, the kinds of vegetation and habitat that can be developed. Figure 5-8 in Section III, "Habitat Development," illustrates this point. Configuration of the site plays a large role in determining what uses should be planned. Coves on a dredged material island, for example, can lead to successful marsh establishment (Allen, Webb, and Shirley 1983; Swafford and Gorini 1994) because protection from long wind fetches is provided. Topography and land configuration also relate to erodibility, flooding potential, waterway traffic, and future deposition plans of an area. Hills, bluffs, and man-made features influence accessibility and ease of developing desired beneficial uses. Monitoring of these factors is best achieved with an aerial photograph, topographic map, and diagram as a base. Elevational and bathymetric data may be unavailable and will have to be established by standard survey and geodetic procedures. A map or diagram should show access routes, both land and water, as means of transporting equipment; these routes should be rated. The map or diagram should show dikes, mounds, or other evidence of previous placement, and areas of debris accumulation and indications of nearby human activity, such as a boat dock, cabin, foot trail, or livestock, should be noted. See references in Environmental Laboratory (1978) and Hayes et al. (2000) for techniques on reconnaissance mapping.

d. Soils or dredged material substrate. Analysis of core samples and soil sampling data should be made on existing soils to determine undesirable physical and/or chemical properties that may pose a hazard to potential site use. If proper procedures are not taken, it is possible that buried undesirable materials could migrate upward through the water column. See Lee et al. (1985) for procedures to be used in sampling and analyzing soils and for ways to handle any potentially hazardous soils. If the dredged material sediments already in place are to be used for beneficial uses, some physical and chemical tests must be conducted. Soil properties influence kinds of plant species that can be grown on the site or that will invade the site. These plants, in turn, will ultimately affect other beneficial uses to be planned. Similar physical and chemical soil tests will also be necessary for dredged material sediments, since these materials will be the growing medium for plants. See Lee et al. (1985) for the determination of soil or sediment properties. After soil properties are determined, soil scientists should be consulted to determine which soil treatments are required to ensure adequate plant development. Periodic monitoring of the soil properties of the site should be carried out since fertilization and other soil amendments and physical treatments may be necessary to ensure site beneficial uses are not adversely affected by changing soil conditions. The frequency of monitoring will largely be determined by economic and time constraints.

e. Tides, waves, currents, and other hydrologic data. These factors influence water and nutrient availability to plants and animals and cause erosion. For salt marsh development, vertical elevation of a substrate with respect to tidal fluctuations determines the number of times per year the substrate and plants will be flooded with salt water. The average number of hours submerged per month and the average number of hours submerged during daylight are important in determining plant distribution (Chapman 1976). Because of the energy they exert upon a site and the potential erosion, waves can influence plant establishment. Fetch, or the distance wind travels across water to reach land, and the depth of water are primary determinants of the degree of wave energies. Knutson and Inskeep (1983) relate a method for evaluating wave climate based on observed relationships between fetch, shore configuration, grain size, and success in controlling erosion in 86 salt marsh plantings in 12 coastal states. Of course, direct measurements for characterizing tides and waves can be accomplished through electronic gauges or by physically reading tides and waves on staff rods. Currents are normally considered when dredged material is deposited in rivers and streams. Currents have a direct effect on whether plants can become established. Current meters should be installed on the site and monitored for several months throughout the year to obtain a knowledge of maximum and minimum current conditions. Other hydrologic factors, such as water table and water levels or depths, also directly influence planned beneficial uses due to their effect on plant establishment and zonation. Water table, levels, and depths will influence the ability of plants to carry out their physiological processes (for example, photosynthesis and respiration). Some plants can tolerate more or less water than others, which will in turn dictate what vegetation can be grown on a dredged material site. The vegetation will largely dictate the kinds of animal habitat that can be developed or the kinds of animals that will use the site. A procedural guide for monitoring such things as depths to water table and other hydrologic factors can be found in Lee et al. (1985).

f. Water quality. Salinity, pH, turbidity, dissolved oxygen, biological oxygen demand, chemical oxygen demand, and mineral nutrients within the water column will largely influence the kinds of plants and aquatic fauna that will develop on or adjacent to a dredged material site (USEPA 1979; Thom and Wellman 1996). They should be monitored periodically prior to, during, and after dredging to obtain an idea of how water quality conditions might change over time, which in turn might affect plant and animal development. (See Section II, "Logical Connections," for sampling and laboratory requirements and procedures regarding water quality factors.)

5.62.4.2 Biological factors. Biological factors considered important to monitor include aquatic, semiaquatic, and upland plant species; all animal species, including soil macro-invertebrates, microfauna, and benthos; and shellfish and finfish.

a. Vegetation. Knowledge of existing plant species on or adjacent to the site will enable plant species selection. Indigenous plants may be desirable for various beneficial uses, such as wildlife habitat development, agricultural, forestry, or horticultural purposes. The vegetation composition and distribution can be mapped from either visual estimation or sampling. Reconnaissance mapping and map use for various purposes, including wildlife and vegetation, and a guide to gaining natural resource information through remote sensing techniques are discussed in Environmental Laboratory (1978) and Hayes et al. (2000). This guide includes

vegetation and animal habitat inventory and assessment. Gysel and Lyon (1980) provide habitat analysis and evaluation methods suitable for vegetation description and other site attributes. Sampling methods are not standardized for vegetation but must be tailored to the type and areal extent of vegetation and the level of information required. Excellent general references for monitoring vegetation include Chapman (1976), Grieg-Smith (1964), and Kershaw (1973). Ohman and Ream (1971) provide a guide of sampling and summarizing data for plant community surveys and classification, including methods, data sheets, and computer summarization printouts. The specific location of any plants protected by law should be noted when sampling vegetation. A botanist familiar with the area should be consulted for species verification; regional botanical field guides such as Britton and Brown (1985), Godfrey and Wooten (1979), Pierce (1977), and Silberhorn (1976) will be helpful.

b. Animals. Both aquatic and upland animals on and adjacent to the dredged material site should be monitored. Important economic species such as shrimp and other associated shellfish may be in adjacent waters and could be cultured and developed on the dredged material site. Furbearing animals such as beaver and otter may be in the area and could be attracted to the site for trapping pelts or other beneficial uses. Monitoring of smaller animals is important because they are part of the food web and can provide insight to use by larger predatory animals. Current and future animal use of a site, in general, should be determined through observation of signs such as tracks or browse marks, actual observations, or some form of sampling. For example, in sampling both aquatic and upland animals on dredged material in the intertidal zone of a Texas site near Galveston, monthly observations at exact locations were made. Aquatic invertebrates on the water bottom that may be covered during the dredging process or during beneficial use development should be described by species composition, abundance, and distribution.

(1) For information on sampling techniques, consult Frey, Basan, and Scott (1973), which discusses sampling of salt marsh benthos and burrows; Little and Quick (1976), which describes a reconnaissance technique for oysters; and Wolf, Shanholtzer, and Reimold (1970), which describes sampling for fiddler crabs in salt marsh. Other aquatic animal sampling and monitoring methods for plankton, periphyton, macrophyton, macroinvertebrates, and fish are amply discussed in Weber (1973).

(2) For purposes of definition, discussion in this manual of monitoring upland animals includes those animal species, such as waterfowl and colonial nesting birds, that use unflooded land for any of their life requisites. Schemnitz (1980) provides numerous methods of monitoring primarily upland animal species. Another general reference that applies primarily to upland animal monitoring is Johnson, Franklin, and Krebill (1984). Gysel and Lyon (1980) provide an excellent discussion on estimation of density of primarily upland animals by use of the line transect method.

(3) For dredged material that will be or has been deposited in a floodplain, Uetz et al. (1979) provide a sampling method for floodplain arthropods although they state there is no single sampling method applicable to studies of arthropods as these animals vary in mobility and microhabitat preferences. Additional literature on sampling methods of upland animal populations includes Bond (1957), Caughley (1977), Kendeigh (1944), Marion and Shamis (1977), and Neff (1968). A wildlife biologist familiar with the proposed or existing dredged

material site can estimate wildlife use of the site and should be consulted about the presence of threatened, rare, or endangered species. Critical habitat and areas of concern for these species must be located, protected, and/or enhanced in every dredging project. Contract monitoring information is provided by Sturgis (1990) and Landin, Hayes, and Payne (1997).

5.62.5 Conclusion. Monitoring methodology should be tailored to the nature of the project, its goals, and the overall reason for monitoring. It is important to understand that monitoring for the sake of monitoring is not helpful in learning where a habitat is functioning or whether a beneficial use is working. In the case of beneficial uses, the purpose of monitoring is to ensure that dredged material operations eventually lead to some planned beneficial uses that provide a return in natural resources, in economics, or in other gains. Monitoring methodology can be as simple as a yearly recording of presence or absence or as intensive as necessary to establish and document a management program or provide statistically reproducible data to protect legal interests. Note that the equipment and methodologies used and the measurements taken are based on project goals and functions of what has been impacted or changed, and they are used to determine both the success of an overall project and whether the predetermined success criteria of the project have been met.

## Section XV Site Valuation

### 5.63 Evaluation.

5.63.1 Dredging in our Nation's waterways and harbors is necessary to maintain navigation. Dredging is also a part of USACE flood-control work in large rivers and streams of the United States. Still further, Section 404 dredge and fill permits are required, and mitigation may be necessary for other types of dredging work. The costs of dredging can sometimes be justified by documenting the benefits that can be derived from a network of navigable waterways. Tangible dollar benefits are generally savings in shipping costs realized by shippers using the waterways or a measurement of property and lives protected by a flood-control or reservoir structure. In addition to dredging costs, the costs of placement of dredged material from waterways are substantial. In conventional placement operations, potential benefits were once ignored, and the cost of the placement operation was simply part of the total cost of the entire dredging-placement project. With new laws and regulations that give the USACE the opportunity to accomplish beneficial uses over and above bottom-line project costs, potential benefits are carefully determined and evaluated, and they incorporated into project plans and designs.

5.63.2 Dredged material can provide socioeconomic benefits if beneficial uses are implemented. Uses of either the material itself or the containment area in which it is placed are options. Land enhancement benefits from the placement of dredged material can be substantial, and highly productive habitat can be developed on placement sites. The value of new or filled land or of a wetland or other habitat created by placement of material dredged from a project is a valid benefit that can be credited to the overall project. Both new and maintenance dredging projects should evaluate land enhancement and beneficial use alternatives. An analysis should also be made of the associated socioeconomic benefits and costs of the placement of dredged

material. This process should consider several alternatives for placement, including beneficial uses, and it should consider all benefits and costs, tangible as well as intangible. A number of factors need to be considered in benefits, including attitudes and opinions of local citizens, resource agencies, and environmental groups, the general public good, and distinguishing or limiting historical or archaeological features (Skjei 1976; King and Constanza 1994).

5.63.3 To aid in the evaluation of the land enhancement value and associated benefits that can be derived by the beneficial use of dredged material containment areas, a land value methodology has been developed for certain types of beneficial uses. The methodology is basically designed to provide guidance for projects still in the early planning stages and produces estimates of the direct market value of the created land, the related community benefits, and adverse impacts from the land use. The use of this methodology can help highlight the many advantages of the beneficial land use of dredged material. Project sponsors and local officials may gain wider public support for beneficial use projects if they can effectively demonstrate to the community the full range of benefits from project implementation.

#### 5.64 Methodology.

5.64.1 Base of appraisal. The basis for the land value portion of the methodology is the comparable sales approach often used in real estate appraisal. This approach was considered the most appropriate for the value estimate of newly created land from dredged material. For the assessment of associated benefits and adverse impacts resulting from the land use project, a matrix has been devised to categorize and describe all relevant effects. The methodology itself can be divided into site description, establishment of use potential, estimate of value, and associated benefits and adverse impacts. The first three collectively estimate the site value changes; the fourth identifies the associated benefits and/or adverse impacts of the land use project.

5.64.2 Site description. Before an analysis of the value of a site can begin, the site must be described in terms of its physical features, environmental setting (including natural and man-made areas), and relationship to the economic structure of the area. This phase of the methodology is primarily a database for subsequent analyses. Many of the items of importance to the value of the prepared site will emerge during the course of this data-gathering task. Taking the required time to develop the data needed for this section of the methodology enables the final estimate of value to be made with more confidence.

5.64.3 Establishment of use potential. This section of the methodology establishes the most likely and the highest and best use of the containment area after the dredged material has been placed, dewatered, and consolidated. Normally, the highest and best potential use of a piece of land, within existing legal and institutional constraints, is employed as the basis for the value assessment. Values of comparable land in the area determine the value of the new piece of land. The use potential is established by identifying current land uses surrounding the site, the need for certain land uses within the area, the zoning intensity of various levels of development, and other institutional and legal constraints. Also, the physical characteristics previously identified must be considered. For example, a placement site made of fine-grained dredged material is not suitable for high-rise developments despite other positive attributes, but it may have use as a recreation site, where low-load structures may be safely erected, or as a wildlife habitat and nature area.

Finally, the accessibility of the site to the existing infrastructure is an important determinant of practical use potential.

#### 5.64.4 Estimate of value.

5.64.4.1 This is the final stage of the methodology in the actual site valuation process. For the successful accomplishment of a value estimate, an economist or real estate appraiser familiar with land values should be involved. Three key functions must be performed in the estimation process:

a. Land parcels similar to the site must be created by the containment area, and recent sale or assessment data must be identified.

b. An estimate of demand or need for the new site must be made based on the information obtained in the estimate of use potential.

c. The relative applicability of the comparable sites versus the new site for beneficial uses must be determined.

5.64.4.2 Values of comparable parcels are the basis on which the market value estimate is made. Once the comparables have been identified and their value established, a utility estimate is made to determine how similar, with respect to “value-producing” factors, the comparables and the new site are. If the comparables and the new site are similar with respect to accessibility, zoning restrictions, proximity to public services, foundation constraints, and so on, then the comparables can be considered to have equal utility to the new site and be used to establish site value. Using the relative utility measure and the demand for the new land use, an adjusted value for the new site can be estimated. By comparing this value estimate with the original value of the site before the dredged material was deposited, a land enhancement benefit can be estimated for whatever beneficial use has been proposed.

5.64.4.3 Before an estimated land valuation can be determined for other than upland human-use sites, values must be determined for such potential site uses as wetlands and other types of habitat development, nonconsumptive recreation, fish nursery areas, commercial and non-commercial shellfish and finfish industries, aquatic vegetation, endangered species critical habitat, water quality, and other difficult-to-estimate variables. These types of values are extremely controversial and hard to assess. None of the scientists working in their fields in the development of values agree on uniform estimates. Values often need to be assigned on a site-specific basis. The USACE Engineer Research and Development Center (ERDC) has been coming to grips with this problem through the Dredging Operations Technical Support (DOTS) Program and the Wetlands Research Program (WRP). ERDC often assists Districts in reaching estimated values of new or proposed dredged material or mitigated sites.

#### 5.64.5 Associated benefits and adverse impacts.

5.64.5.1 The direct increase in market value of a site from the placement of dredged material is an important land enhancement benefit; however, the induced associated benefits and/or adverse impacts can also be substantial. These benefits and impacts may touch many



different economic groups in a wide geographic range away from the site. The methodology can assist in identifying these benefits and impacts, describing their magnitude and significance, and displaying them for decision makers and the public.

5.64.5.2 Two guides were developed by Conrad and Pack (1978) to assist in identifying the significant benefits and impacts resulting from the beneficial use of dredged material containment areas. One guide graphically shows the relationships of various categories of effects that could result from a productive land use. The other lists specific types of social, economic, and environmental factors that might be affected by the beneficial use. These guides are by no means all-encompassing; rather, they provide a framework for identification of the important benefits and adverse impacts.

5.64.5.3 Once the benefits and adverse impacts are identified, a matrix can be used to describe and evaluate them. The matrix should have a simple structure, and the evaluation is based on the judgment involved in the process. No general weighting system was considered appropriate for the evaluation of these associated benefits and adverse impacts. However, a matrix should allow this subjective evaluation to be displayed so that other interested parties can review them. When using this methodology, one should remember that the entire methodology is intended as a set of guidelines, and it involves the application of sound judgment in a multidisciplinary group. Deviation from the methodology may be warranted where sound judgment dictates that the situation being investigated does not lend itself to application of the methodology, such as when dealing with habitat applications of a site.

5.65 Case Studies. When developing the methodology, Conrad and Pack (1978) examined 15 case study sites and then tested the methodology on each. As developed, the methodology is to be used on undeveloped sites for planning purposes. However, sites that were already developed were selected in the interest of getting a diverse group for testing. The results of the case studies indicated that the methodology is flexible and adaptable to a wide range of sites. Table 5-10 lists the case study sites along with their physical and dredged material characteristics. Table 5-11 shows the settings of the case study sites, and Table 5-12 is a compilation of the estimated change in land values of the sites as a result of their development for upland beneficial use. The values indicate that, through beneficial use application, dredged material containment areas can realize significant increases in value. The wide range of value increases shows that the value increase is a site-specific characteristic. The methodology, however, allows an estimation of this change before the site is developed. Finally, Table 5-13 shows the types of associated benefits and adverse impacts that were encountered during the case studies. Details of the case studies are available in Conrad and Pack (1978).

5.66 Use of the Methodology. The large land enhancement benefits that can accrue from the beneficial use of dredged material make this alternative to conventional placement particularly attractive. The methodology described in this section is designed to be used in the planning stages to identify and evaluate the tangible increase in market value as well as other benefits to be derived from beneficial upland use. It also helps ensure that appropriate placement alternatives will not be overlooked. The methodology does not, however, apply to sites that are not used as upland human-use sites, such as wetlands. Paragraph 5.64.4 discusses of valuation of such sites.

Table 5-10. Case Study Site Physical and Dredged Material Characteristics  
(from Conrad and Pack 1978)

Site	Location	Approximate Size		Type	Soil Characteristics			Depth to Foundation Strata	
		ha	acres		Grain Size	Bearing Capacity	Vegetative Support	m	ft
Anacortes	Anacortes, WA	11	26	Sand/clay	Fine	Fair	Good	8	25
Artificial Island	Salem County, NJ	81	200	Silty clay loam	Fine	Fair	Good	21	70
Bay Port	Green Bay, WI	233	575	Sand/clay	Fine	Poor	Good	5	15
E. Potomac Park	Washington, DC	133	329	Silt/clay	Fine	Poor	Good	31	100
Fifth Avenue Marina	San Diego, CA	9	22	Fine sand	Fine	Fair	Good	N/A	N/A
Florida State Fairgrounds	Hillsborough Co., FL	112	276	Silt/clay	Fine	Poor	Good	N/A	N/A
Hookers Point	Tampa, FL	162	400	Silt/clay	Fine/medium	Fair	Good	N/A	N/A
Hoquiam	Hoquiam, WA	18	45	Sand/silt	Fine	Fair	Good	10	34
Patriots Point	Charleston, SC	182	450	Silty loam	Fine	Poor	Good	18	60
Vicksburg	Vicksburg, MS	142	350	Sand/silt	Fine	Good	Good	12	40
Virginia Beach	Virginia Beach, VA	17	43	Sand/clay	Fine to medium	Fair	Poor	N/A	N/A
Pelican Island	Galveston, TX	1,306	3,225	Silt/clay	Fine	Fair	Good	N/A	N/A
Port Jersey	Jersey City, NJ	172	430	Sand/clay	Fine to medium	Fair	Poor	23	75
Blount Island	Jacksonville, FL	680	1700	Silt/clay	Fine	Good	Good	25	80
Rivergate	Memphis, TN	172	425	Sand/clay	Medium	Good	Good	N/A	N/A

Table 5-11. Case Study Site Settings (from Conrad and Pack 1978)

Site Name	Productive Use	Water and Sewer	Urban Setting	Zoning	Access
Anacortes	Industrial/ manufacturing	To site	Urban/port	Industrial/ urban	Excellent
Artificial Island	Nuclear power plant	Home nearby; developed their own services	Rural	Industrial/ urban	Poor
Bay Port	Industrial/port	Nearby	Urban	Industrial/ urban	Good
E. Potomac Park	Park	Onsite	Urban	Open space	Excellent
Fifth Avenue Marina	Marine/park	Adjacent to site	Urban	Open space	Excellent
Florida State Fairgrounds	State fairgrounds	Onsite	Suburban	Urban transition	Good
Hookers Point	Industrial/port facility	Onsite	Urban/port	Industrial/ urban	Excellent
Hoquiam	Industrial/ manufacturing	0.2 km (0.13 mi) from site	Urban/port	Industrial/ urban	Good
Patriots Point	Museum/marina/ golf course, hotel	Water extended to site; package sewage treatment plant installed.	Suburban	Commercial/ agricultural/ open space	Fair
Vicksburg	Industrial/ manufacturing	Adjacent to site	Suburban	None	Good
Virginia Beach	Beach front commercial	Adjacent to site	Urban	Residential/ commercial	Excellent
Pelican Island	Industrial/ residential/ institutional/ recreational	To site	Urban	Industrial/ residential/ open space	Excellent
Port Jersey	Industrial/ commercial	Onsite	Urban	Industrial	Excellent
Blount Island	Industrial	To site	Suburban	Industrial	Excellent
Rivergate	Industrial	Onsite	Suburban	Manufacturing	Excellent

Table 5-12. Case Study Site Valuation Study (from Conrad and Pack 1978)

Site Name	Used Considered for Valuation	Raw Value Prior to Dredged Material Placement <sup>1</sup>		Adjusted Present Value		Enhancement Value	
		per ha	per acre	per ha	per acre	per ha	per acre
Anacortes	Industrial/ port	\$5,400	\$2,200	\$43,200	\$17,500	\$37,800	\$15,300
Artificial Island	Nuclear power generation	\$12	\$5	\$3,200	\$1,300	\$3,200	\$1,300
Bay Port	Heavy industrial	Nominal	Nominal	\$16,100	\$6,500	\$16,100	\$6,500
E. Potomac Park	Recreational	None	None	\$645,900	\$261,500	\$645,900	\$261,500
Fifth Avenue Marina	Recreational/ open space	\$10,800 - \$26,900	\$4,300 - \$10,900	\$1.94 - \$2.60 M	\$784,000 - \$1.0 M	\$1.92 - \$2.60 M	\$779,000 - \$1.0 M
Florida State Fairgrounds	Commercial/ retail	\$11,100	\$4,500	\$106,300	\$43,000	\$95,100	\$38,500
Hookers Point	Deepwater terminal facilities	Nominal	Nominal	\$160,600	\$65,000	\$160,600	\$65,000
Hoquiam	Industrial/ port	\$2,000	\$800	\$13,100	\$5,300	\$11,100	\$4,500
Patriots Point	Commercial/ recreational	\$5	\$2	\$43,000	\$17,400	\$43,000	\$17,400
Vicksburg	Industrial/ port	N/A	N/A	N/A	N/A	N/A	N/A
Virginia Beach	Commercial/ retail	\$5,600/ front m	\$1,700/ front ft	\$5,600/ front m	\$1,700/ front ft	Maintenance value	Maintenance value
Pelican Island	Industrial/ residential	\$1,725	\$700	\$19,266	\$7,800	\$17,540	\$7,100
Port Jersey	Industrial	\$35,000	\$14,000	\$198,000	\$79,000	\$163,200	\$65,200
Blount Island	Industrial	\$16,055	\$6,500	\$83,360	\$33,750	\$67,305	\$27,250
Rivergate	Manufacturing	\$11,100	\$4,500	\$134,500	\$54,500	\$123,400	\$50,000

<sup>1</sup> 1997 dollars; "M" = million

Table 5-13. Case Study Sites—Associated Benefits/Adverse Impacts  
(from Conrad and Pack 1978)

Associated Benefits/ Adverse Impacts	Anacortes	Artificial Island	Bay Port	E. Potomac Park	Fifth Avenue Marina	Florida State Fairgrounds	Hookers Point	Hoquiam	Patriots Point	Vicksburg	Virginia Beach	Pelican Island	Port Jersey	Blount Island	Rivergate
Adjusted value increase						X	X				X				
Increased business activity			X		X	X	X				X		X		X
New jobs	X	X	X			X	X	X	X	X	X	X	X	X	X
Increased taxes/ Revenues	X	X	X		X			X		X	X				
Sales	X					X	X	X	X		X	X			X
Real estate	X		X			X	X					X	X	X	X
Community attractiveness				X	X	X			X		X				
General boost to economy	X		X			X	X		X			X		X	X
Operations revenue						X	X		X						
Provide needed community facilities				X	X	X	X						X		
Increased recreation opportunities				X	X	X			X		X	X			
Construction jobs		X					X					X	X		X
Utility taxes		X													X
Decrease in area taxes		X													
Public education (re: nuclear power plants)		X													

Table 5-13 (Concluded).

Associated Benefits/ Adverse Impacts	Anacortes	Artificial Island	Bay Port	E. Potomac Park	Fifth Avenue Marina	Florida State Fairgrounds	Hookers Point	Hoquiam	Patriots Point	Vicksburg	Virginia Beach	Pelican Island	Port Jersey	Blount Island	Rivergate
Increased congestion		X			X				X		X			X	
Higher property taxes												X			
Environmental degradation		X	X						X	X				X	
Increased municipal expenses					X										
Limits area development potential		X	X												
Community concern		X								X		X		X	
Detracts from adjacent vistas									X						
Improved medical care services		X													
Provide needed power		X													
Educational/ Cultural opportunities									X						
Expands area tourist potential									X						
Introduce alternative transportation mode							X		X		X		X	X	
Create site for administrative offices				X											X

## APPENDIX A

## References

A.1 Required Publications.

Required publications listed below provide guidance to USACE personnel concerned with the planning, design, construction, operation, and maintenance of navigation (dredging) projects. Most of the Engineer Manuals (EMs), Engineer Pamphlets (EPs), Engineer Regulations (ERs), and Engineer Technical Letters (TLs) are available at <http://publications.usace.army.mil/publications/> and Policy Guidance Letters (PGLs) at <http://planning.usace.army.mil/toolbox/library.cfm?Option=Start>. U.S. Environmental Protection Agency/U.S. Army Corps of Engineers (USEPA/USACE) guidance documents are available at <http://www.epa.gov/>.

## A.1.1 Code of Federal Regulations (CFR).

## 33 CFR

Title 33 – Navigation and Navigable Waters; Chapter II – Corps of Engineers, Department of the Army, Department of Defense.

Part 230 – Procedures for Implementing NEPA.

Part 325 – Processing of Department of the Army Permits.

Part 335 – Operation and Maintenance of Army Corps of Engineers Civil Works Projects Involving the Discharge of Dredged or Fill Material into Waters of the U.S. or Ocean Waters

Part 336 – Factors to be Considered in the Evaluation of Army Corps of Engineers Dredging Projects Involving the Discharge of Dredged Material into Waters of the U.S. and Ocean Waters.

Part 337 – Practice and Procedure.

Part 338 – Other Corps Activities Involving the Discharge of Dredged Material or Fill into Waters of the U.S.

## 40 CFR

Title 40 – Protection of Environment; Chapter I – Environmental Protection Agency.

Part 225 – Corps of Engineers Dredged Material Permits.

Part 227 – Criteria for the Evaluation of Permit Applications for Ocean Dumping of Materials.

Part 228 – Criteria for the Management of Disposal Sites for Ocean Dumping.

Part 230 – Section 404(b)(1) Guidelines for Specification of Disposal Sites for Dredged or Fill Material.

EM 1110-2-5025

31 Jul 15

Part 1502 – Environmental Impact Statement.

A.1.2 Engineer Manuals (EM).

EM 200-1-4

Risk Assessment Handbook – Volumes I: Human Health Evaluation.

EM 385-1-1

Safety and Health Requirements Manual.

EM 1110-1-1003

NAVSTAR Global Positioning System Surveying.

EM 1110-1-1802

Geophysical Exploration for Engineering and Environmental Investigations.

EM 1110-1-1804

Geotechnical Investigations.

EM 1110-1-1905

Bearing Capacity of Soils.

EM 1110-1-2909

Geospatial Data and Systems.

EM 1110-2-410

Design of Recreation Areas and Facilities – Access and Circulation.

EM 1110-2-1003

Hydrographic Surveying.

EM 1110-2-1202

Environmental Engineering for Deep-Draft Navigation Projects.

EM 1110-2-1206

Environmental Engineering for Small Boat Basins.

EM 1110-2-1416

River Hydraulics.

EM 1110-2-1611

Layout and Design of Shallow-Draft Waterways.

EM 1110-2-1613

Hydraulic Design Guidance for Deep-Draft Navigation Projects.



EM 1110-2-1615  
Hydraulic Design of Small Boat Harbors.

EM 1110-2-1902  
Slope Stability.

EM 1110-2-1906  
Laboratory Soils Testing.

EM 1110-2-1907  
Soil Sampling.

EM 1110-2-1908  
Instrumentation of Embankment Dams and Levees.

EM 1110-2-1911  
Construction Control for Earth and Rock-Fill Dams.

EM 1110-2-2300  
Earth and Rock-Fill Dams – General Design and Construction Considerations.

EM 1110-2-3301  
Design of Beach Fills.

EM 1110-2-5026  
Beneficial Uses of Dredged Material.

EM 1110-2-5027  
Confined Disposal of Dredged Material.

A.1.3 Engineer Pamphlets (EP).

EP 1130-2-520  
Navigation and Dredging Operations and Maintenance Guidance and Procedures.

A.1.4 Engineer Regulations (ER).

ER 200-2-2  
Policy and Procedures for Implementing NEPA.

ER 1105-2-100  
Planning Guidance Notebook.

ER 1110-1-8156  
Policies, Guidance, and Requirements for Geospatial Data Systems.

EM 1110-2-5025

31 Jul 15

ER 1110-2-1150

Engineering and Design for Civil Works Projects.

ER 1110-2-1302

Civil Works Cost Engineering.

ER 1110-2-1403

Studies by Coastal, Hydraulic, and Hydrologic Facilities and Others.

ER 1110-2-1404

Hydraulic Design of Deep-Draft Navigation Projects.

ER 1110-2-1457

Hydraulic Design of Small Boat Navigation Projects.

ER 1110-2-1458

Hydraulic Design of Shallow Draft Navigation Projects.

ER 1110-2-8151

Monitoring Completed Navigation Projects.

ER 1130-2-406

Shoreline Management at Civil Works Projects.

ER 1130-2-520

Navigation and Dredging Operations and Maintenance Policies.

ER 1165-2-27

Establishment of Wetland Areas in Connection with Dredging.

ER 1165-2-120

Reimbursement for Advance Non-Federal Construction of Authorized Federal Harbor and Inland Harbor Improvements.

ER 1165-2-122

Studies of Harbor or Inland Harbor Projects by Non-Federal Interests.

ER 1165-2-124

Construction of Harbor and Inland Harbor Projects by Non-Federal Interests.

ER 1165-2-130

Federal Participation in Shore Protection.

ER 1165-2-131

Local Cooperation Agreements for New Start Construction Projects.

### A.1.5 Policy Guidance Letters (PGL).

PGL Number 8 1988

PGL Number 8. 19 May 88 - New Start Construction Projects - Responsibility for Utility Relocations on Harbor Projects (ER 1165-2-131 - pg 30, ER 1105-2-100, para 4-7).

PGL Number 9 1988

PGL Number 9. 13 Jun 88 - New Start Construction Projects - Responsibility for Relocation and Removal of Structures and Facilities on Navigation Projects (ER 1165-2-131, pgs 29-31).

PGL Number 10 1988

PGL Number 10. 6 Sep 88 - Section 111, Shore Damage Mitigation (ER 1105-2-100, para 3-22).

PGL Number 14 1989

PGL Number 14. 9 Jan 89 - Revisions to Guidance for Disposal of Materials on Beaches (ER 1105-2-100, para 4-8).

PGL Number 15 1989

PGL Number 15. 7 Apr 89 - Credit for Utility Relocation Costs on Navigation Projects - Modifications to Existing Local Cooperation Agreements (LCAs) (Para 5-7 still in effect. ER 1105-2-100, para 4-7).

PGL Number 17 1989

PGL Number 17. 24 Aug 89 - Formulation and Cost Sharing for Harbor Projects that Include Land Creation (ER 1105-2-100, para 4-7).

PGL Number 20 1989

PGL Number 20. 20 Sep 89 - Reimbursement for Advance Non-Federal Construction of Authorized Federal Harbor and Inland Harbor Improvements (will be in ER 1165-2-120 when revised).

PGL Number 22 1991

PGL Number 22. 22 Nov 91 - Guidance for Placement of Materials on Beaches.

PGL Number 28 1990

PGL Number 28. 19 Dec 90 - Improvements for Navigation Safety and Reduction in Damages from Tide and Wave Sources (Rescission of PGL 23).

PGL Number 31 1991

PGL Number 31. 15 Nov 91 - Implementation of Section 208 of Water Resources Development Act of 1986.

PGL Number 35 1992

PGL Number 35. 17 Mar 92 - Section 312 of the Water Resources Development Act of 1990 (WRDA 90), Environmental Dredging.

EM 1110-2-5025

31 Jul 15

PGL Number 40 1993

PGL Number 40. 25 Mar 93 - Development and Financing of Dredged Material Management Studies.

PGL Number 42 1993

PGL Number 42. 26 Oct 93 - Additional Guidance on Financing Dredged Material Management Studies.

PGL Number 44 1995

PGL Number 44. 20 Oct 95 - Relocations and Removals at Navigation (Harbor) Projects.

PGL Number 47 1998

PGL Number 47. 3 Apr 98 - Cost-Sharing for Dredged Material Disposal Facilities and Dredged Material Disposal Facility Partnerships.

PGL Number 49 1998

PGL Number 49. 28 Jan 98 - Section 312 of the Water Resources Development Act of 1990, Environmental Dredging, As Amended by Section 205 of the Water Resources Development Act of 1996.

PGL Number 62 1999

PGL Number 62. 29 Jul 99 - Navigation (Harbors) Cost Sharing Policy Applications.

A.1.6 Public Laws (PL).

PL 91-190

National Environmental Policy Act (NEPA) of 1969.

PL 92-500

Clean Water Act.

PL 92-532

Marine Protection, Research, and Sanctuaries Act (MPRSA) (Ocean Dumping Act).

PL 92-583

Coastal Zone Management Act of 1972.

PL 94-587

Water Resources Development Act (WRDA) of 1976.

PL 99-662

Water Resources Development Act (WRDA) of 1986.

PL 102-580

Water Resources Development Act (WRDA) of 1992.

#### A.1.7 U.S. Army Corps of Engineers (USACE).

##### USACE 2003

U.S. Army Corps of Engineers. 2003. "Evaluation of Dredged Material Proposed for Disposal at Island, Nearshore, or Upland Confined Disposal Facilities – Testing Manual" ["Upland Testing Manual"], Technical Report ERDC/EL TR-03-1, U.S. Army Engineer Research and Development Center, Vicksburg, MS.

#### A.1.8 U.S. Environmental Protection Agency/U.S. Army Corps of Engineers (USEPA/USACE)

##### USEPA/USACE 1984

U.S. Environmental Protection Agency/U.S. Army Corps of Engineers. 1984. "General Approach to Designation Studies for Ocean Dredged Material Disposal Sites," U.S. Army Corps of Engineers Water Resources Support Center, Washington, DC.

##### USEPA/USACE 1991

U.S. Environmental Protection Agency/U.S. Army Corps of Engineers. 1991. "Evaluation of Dredged Material Proposed for Ocean Disposal–Testing Manual," EPA 503/8-91/001, Washington, DC. [http://water.epa.gov/type/oceb/oceandumping/dredgedmaterial/gbook\\_index.cfm](http://water.epa.gov/type/oceb/oceandumping/dredgedmaterial/gbook_index.cfm)

##### USEPA/USACE 1996

U.S. Environmental Protection Agency/U.S. Army Corps of Engineers. 1996. "Guidance Document for Development of Site Management Plans for Ocean Dredged Material Disposal Sites," U.S. Environmental Protection Agency, Office of Water 45045. [http://water.epa.gov/type/oceb/oceandumping/dredgedmaterial/upload/1996\\_smp\\_guidance.pdf](http://water.epa.gov/type/oceb/oceandumping/dredgedmaterial/upload/1996_smp_guidance.pdf)

##### USEPA/USACE 1998

U.S. Environmental Protection Agency/U.S. Army Corps of Engineers. 1998. "Evaluation of Dredged Material Proposed for Discharge in Waters of the U.S. – Testing Manual" ["Inland Testing Manual"], EPA-823-F-98-005, Washington, DC.

##### USEPA/USACE 2004

U.S. Environmental Protection Agency/U.S. Army Corps of Engineers. 2004. "Evaluating Environmental Effects of Dredged Material Management Alternatives – A Technical Framework," EPA 842-B-92-008, revised May 2004, Washington, DC.

##### USEPA/USACE 2007

U.S. Environmental Protection Agency/U.S. Army Corps of Engineers. 2007. "Identifying, Planning, and Financing Beneficial Use Projects Using Dredged Material," Washington, DC.

##### USEPA/USACE Technical Committee on Criteria for Dredged and Fill Material 1991

U.S. Environmental Protection Agency/U.S. Army Corps of Engineers Technical Committee on Criteria for Dredged and Fill Material. 1991. "Ecological Evaluation of Proposed Discharge of

Dredged Material into Ocean Waters; Implementation Manual for Section 103 of PL 92-532,” U.S. Army Engineer Waterways Experiment Station, Vicksburg, MS.

## A.2 Related Publications.

### AASHTO

American Association of State Highway and Transportation Officials. “The Materials Book – Standard Specifications for Transportation Materials and Methods of Sampling and Testing,” Washington, DC.

### Abood, Lawler, and Disco 1969

Abood, K. A., Lawler, J. P., and Disco, M. D. 1969. “Utility of Radioisotope Methodology in Estuary Pollution Control Study; 1: Evaluation of the Use of Radioisotopes and Fluorescent Dyes for Determining Longitudinal Dispersion,” Report NYO-3961-1, U.S. Atomic Energy Commission, New York.

### A. D. Little, Inc. 1975

A. D. Little, Inc., 1975. “A Feasibility Study of Lawn Sod Production and/or Related Activities on Dredged Material Disposal Sites,” Contract Report D-75-1, U.S. Army Engineer Waterways Experiment Station, Vicksburg, MS.

### Alexander, Murphy, and Scott 1996

Alexander, M., Murphy, M., Scott, S. 1996. “Innovative Dredging Operations Monitoring for the Oakland Deepening Project,” *Proceedings of the Western Dredging Association Seventeenth Technical Conference and Twenty-Ninth Annual Texas A&M Dredging Seminar*, pp 253-270.

### Allen and Hardy 1980

Allen, K. O., and Hardy, J. W. 1980. “Impacts of Navigational Dredging on Fish and Wildlife: A Literature Review,” FWS/OBS-80/07, U.S. Fish and Wildlife Service, Washington, DC.

### Allen et al. 1978

Allen, H. H., Clairain, E. J., Jr., Diaz, R. J., Ford, A. W., Hunt, L. J., and Wells, B. R. 1978. “Habitat Development Field Investigations, Bolivar Peninsula Marsh and Upland Habitat Development Site, Galveston Bay, TX: Summary Report,” Technical Report D-78-15, U.S. Army Engineer Waterways Experiment Station, Vicksburg, MS.

### Allen, Webb, and Shirley 1983

Allen, H. H., Webb, J. W., and Shirley, S. O. 1983. “Erosion Control with Saltmarsh Vegetation,” *Proceedings 3rd Symposium on Coastal and Ocean Management Conference*, San Diego, CA. American Society of Civil Engineers, New York, NY, pp 735-748.

### American Malacological Union 1986

American Malacological Union. 1986. “Entrainment of Oyster Larvae by Hydraulic Cutterhead Dredging Operations,” *American Malacological Bulletin*, Special Edition No. 3.

## American Public Health Association 1985

American Public Health Association. 1985. "Standard Methods for the Examination of Water and Wastewater," 16th ed., prepared and published jointly by American Public Health Association, American Water Works Association, Water Pollution Control Federation, Washington, DC.

## American Public Health Association 1998

American Public Health Association. 1998. "Standard Methods for the Examination of Water and Wastewater." 20th ed., Andrew D. Eaton, Lenore S. Clesceri, Arnold E. Greenberg, Mary Ann H. Franson, ed., prepared and published jointly by American Public Health Association, American Water Works Association, Water Environment Federation, Washington, DC.

## American Society of Civil Engineers (ASCE) 1976

American Society of Civil Engineers (ASCE). 1976. "Subsurface Investigation for Design and Construction of Foundations for Buildings," *Manuals and Reports on Engineering Practice*, No. 56, New York.

## American Society for Testing and Materials (ASTM) 1992

American Society for Testing and Materials. 1992. "Natural Building Stones: Soil and Rock; Geotextiles," *1992 Annual Book of ASTM Standards*, Vol 04.08, American Society for Testing and Materials, Philadelphia, PA.

## American Society for Testing and Materials (ASTM) 1993

American Society for Testing and Materials. 1993. "Soil and Rock; Dimension Stone; Geosynthetics, Section 4, Construction," *1993 Annual Book of ASTM Standards*, Vol 04.08, American Society for Testing and Materials, Philadelphia, PA.

## Appy 1990

Appy, R. 1990. "The LA/LB2000 Project," *Proc. Beneficial Uses of Dredged Material in the Western United States: Proceedings of a Technical Workshop*, May 1990, San Diego, CA. M. C. Landin, ed., U.S. Army Engineer Waterways Experiment Station, Vicksburg, MS.

## Armstrong, Stevens, and Hoeman 1982

Armstrong, D. A., Stevens, B. G., and Hoeman, J. C. 1982. "Distribution and Abundance of Dungeness Crab and Crangon Shrimp and Dredging-Related Mortality of Invertebrates and Fish in Grays Harbor, Washington," Report No. DA-80-86, Washington Department of Fisheries and U.S. Army Engineer District, Seattle, Seattle, WA.

## Arseneault 1981

Arseneault, J. S. 1981. "Dredge Monitoring Program - 1980," Memorandum No. 5902-121-50-2, Field Services Branch, Environment Canada, Vancouver.

## ASTM D 422

"Standard Test Method for Particle-Size Analysis of Soils," Designation D 422 (1998).

EM 1110-2-5025

31 Jul 15

ASTM D 653

“Standard Terminology Relating to Soil, Rock, and Contained Fluids,” Designation D 653.

ASTM D 854

“Standard Test Method for Specific Gravity of Soils Solids by Water Pycnometer,”  
Designation D 854.

ASTM D 1586

“Standard Test Method for Penetration Test and Split-Barrel Sampling of Soils,”  
Designation D 1586.

ASTM D 1587

“Standard Practice for Thin-Walled Tube Sampling of Soils for Geotechnical Purposes,”  
Designation D 1587.

ASTM D 2113

“Standard Practice for Rock Drilling and Sampling of Rock for Site Investigation,” Designation  
D 2113.

ASTM D 2216

“Standard Test Method for Laboratory Determination of Water (Moisture) Content of Soil and  
Rock by Mass,” Designation D 2216.

ASTM D 2434

“Standard Test Method for Permeability of Granular Soils (Constant Head),”  
Designation D 2434.

ASTM D 2435

“Standard Test Method for One-Dimensional Consolidation Properties of Soils,”  
Designation D 2435.

ASTM D 2487

“Standard Practice for Classification of Soils for Engineering Purposes (Unified Soil  
Classification System),” Designation D 2487.

ASTM D 2573

“Standard Test Method for Field Vane Shear Test in Cohesive Soil,” Designation D 2573.

ASTM D 2938

“Standard Test Method for Unconfined Compressive Strength of Intact Rock Core Specimens,”  
Designation D 2938.

ASTM D 2974

“Standard Test Methods for Moisture, Ash, and Organic Matter of Peat and Other Organic  
Soils,” Designation D 2974.



## ASTM D 3441

“Standard Test Method for Mechanical Cone Penetration Tests of Soil,” Designation D 3441.

## ASTM D 4318

“Standard Test Methods for Liquid Limit, Plastic Limit, and Plasticity Index of Soils,” Designation D 4318.

## ASTM D 4648

“Standard Test Method for Saturated Fine-Grained Clayey Soil,” Designation D 4648.

## ASTM D 6032

“Standard Test Method Determining Rock Quality Designation (RQD) of Rock Core,” Designation D 6032.

## ASTM D 6528

“Standard Test Method for Consolidated Undrained Direct Simple Shear Testing of Cohesive Soils,” Designation D 6528.

## Auld and Schubel 1978

Auld, A. H., and Schubel, J. R. 1978. “Effects of Suspended Sediment on Fish Eggs and Larvae: A Laboratory Assessment,” *Estuarine, Coastal, and Marine Science*, Vol 6, pp 153-164.

## Averett, Perry, and Miller 1990

Averett, D. E., Perry, B. D., Torrey, E. J., and Miller, J. A. 1990. “Review of Removal, Containment, and Treatment Technologies for Remediation of Contaminated Sediment in the Great Lakes,” Miscellaneous Paper EL-90-25, U.S. Army Engineer Waterways Experiment Station, Vicksburg, MS.

## Aziz, Schroeder, and Myers 1994

Aziz, N.M., Schroeder, P. R., and Myers, T. E. 1994. A Predictive Hydrologic Model for Contaminant Leaching and Liner Effectiveness at Dredged Material Confined Disposal Facilities. *Dredging '94: Proceedings of the Second International Conference on Dredging and Dredged Material Placement*, Orlando, FL, 14-16 November, 1994. E. C. McNair, ed., American Society of Civil Engineers, New York, 1507-1519.

## Bak 1978

Bak, R. P. 1978. “Lethal and Sublethal Effects of Dredging on Reef Corals,” *Marine Pollution Bulletin*, Vol 9, pp 14-16.

## Barnard 1978

Barnard, W. D. 1978. “Prediction and Control of Dredged Material Dispersion Around Dredging and Open-Water Pipeline Disposal Operations,” Technical Report DS-78-13, U.S. Army Engineer Waterways Experiment Station, Vicksburg, MS.

EM 1110-2-5025

31 Jul 15

Barnard and Hand 1978

Barnard, W. D., and Hand, T. D. 1978. "Treatment of Contaminated Dredged Material," Technical Report DS-78-14, U. S. Army Engineer Waterways Experiment Station, Environmental Laboratory, Vicksburg, MS.

Bartos 1977a

Bartos, M. J., Jr. 1977a. "Classification and Engineering Properties of Dredged Material," Technical Report D-77-18, U.S. Army Engineer Waterways Experiment Station, Vicksburg, MS.

Bartos 1977b

Bartos, M. J., Jr. 1977b. "Use of Dredged Material in Solid Waste Management," Technical Report D-77-11, U.S. Army Engineer Waterways Experiment Station, Vicksburg, MS.

Basco, Bouma, and Dunlap 1974

Basco, D. R., Bouma, A., and Dunlap, W. 1974. "Assessment of the Factors Controlling the Long-Term Fate of Dredged Material Deposited in Unconfined Subaqueous Disposal Areas," Contract Report D-74-8, U.S. Army Engineer Waterways Experiment Station, Vicksburg, MS.

Biggs 1970

Biggs, R. B. 1970. "Geology and Hydrography; Chesapeake Bay Laboratory, Gross Physical and Biological Effects of Overboard Spoil Disposal in Upper Chesapeake Bay," Natural Resources Institute Special Report 3, University of Maryland, Solomons, MD, pp 7-15.

Bingham 1978

Bingham, C. R. 1978. "Aquatic Disposal Field Investigations, Duwamish Waterway Disposal Site, Puget Sound, Washington; Appendix G: Benthic Community Structural Changes Resulting from Dredged Material Disposal, Elliott Bay Disposal Site," Technical Report D-77-24, U.S. Army Engineer Waterways Experiment Station, Vicksburg, MS.

Black et al. 1957

Black, A., Buswell, A., Eidsness, F., and Black, A. L. 1957. "Review of the Jar Test," *Journal of American Water Works Association*, Vol 49, pp 1914-24.

Blazevich and Nicholas 1977

Blazevich, J. N., and Nicholas, J. 1977. "Monitoring of Trace Constituents During PCB Recovery Dredging Operations: Duwamish Waterways," EPA Report 910/9-77-039 August 1977, USEPA Region X, Seattle, WA.

Boehlert 1984

Boehlert, G. W. 1984. "Abrasive Effects of Mount Saint Helens Ash Upon Epidermis of Yolk Sac Larvae of Pacific Herring," *Marine Environmental Research*, Vol 12, pp 113-126.

Bohlen and Tramontano 1977

Bohlen, W. F., and Tramontano, J. M. 1977. "An Investigation of the Impact of Dredging Operations on Suspended Material Transport in the Lower Thames River Estuary," University of Connecticut, Groton, CT.

Bohlen, Cundy, and Tramontano 1979

Bohlen, W. F., Cundy, D. F., and Tramontano, J. M. 1979. "Suspended Material Distributions in the Wake of Estuarine Channel Dredging Operations," *Estuarine, Coastal, and Marine Science*, Vol 9, pp 699-711.

Bokuniewicz and Gordon 1980

Bokuniewicz, H. J., and Gordon, H. B. 1980. "Deposition of Dredged Sediment at Open Water Sites," *Estuarine, Coastal, and Marine Science*, Vol 10, pp 289-304.

Bokuniewicz et al. 1978

Bokuniewicz, H. J., Gebert, J., Gordon, R. B., Higgins, J. L., Kaminsky, P., Pilbeam, C. C., Reed, M., and Tuttle, C. 1978. "Field Study of the Mechanics of the Placement of Dredged Material at Open-Water Disposal Sites," Technical Report D-78-7, U.S. Army Engineer Waterways Experiment Station, Vicksburg, MS.

Bond 1957

Bond, R. R. 1957. "Ecological Distribution of Breeding Birds in the Upland Forests of Southern Wisconsin," *Ecological Monograph*, Vol. 27, No. 4, pp 351-384.

Boone, Granat, and Farrell 1978

Boone, C. G., Granat, M. A., and Farrell, M. P. 1978. "Aquatic Disposal Field Investigations, Columbia River Disposal Site, Oregon; Evaluative Summary," Technical Report D-77-30, U.S. Army Engineer Waterways Experiment Station, Vicksburg, MS.

Boyd 1975

Boyd, F. C. 1975. "Fraser River Dredging Guide," Technical Report Series No. PAC/T-75-2, Southern Operations Branch, Fisheries and Marine Service, Environment Canada, Vancouver.

Brandon, Schroeder, and Lee 1997

Brandon, D. L., Schroeder, P. R., and Lee, C. R. 1997. "Computerization of the Decision-making Framework: Runoff Toxicity Bioassay Test Results (LAT-R Program)," *Environmental Effects of Dredging Technical Notes* EEDP-04-28, U.S. Army Engineer Waterways Experiment Station, Vicksburg, MS.

Brannon et al. 1990

Brannon, J. M., Pennington, J. C., Gunnison, D., and Myers, T. E. 1990. "Comprehensive Analysis of Migration Pathways (CAMP): Contaminant Migration Pathways at Confined Dredged Material Disposal Facilities," Miscellaneous Paper D-90-5, U.S. Army Engineer Waterways Experiment Station, Vicksburg, MS.

Brannon, Myers, and Tardy 1994

Brannon, J. M., Myers, T. E., and Tardy, B. A. 1994. "Leachate Testing and Evaluation for Freshwater Sediments," Miscellaneous Paper D-94-1, U.S. Army Engineer Waterways Experiment Station, Vicksburg, MS.

EM 1110-2-5025

31 Jul 15

Bray 1975

Bray, R. N. 1975. "Practical Analysis of Dredger Capability," *Proceedings of the First International Symposium on Dredging Technology*, The British Hydromechanics Research Association, pp. 33-41.

Bray, Bates, and Land 1997

Bray, R. N., Bates, A. D., and Land, J. M. 1997. *Dredging, A Handbook of Engineering*, Wiley and Sons, New York.

Brenchley 1981

Brenchley, O. A. 1981. "Disturbance and Community Structure: An Experimental Study of Bioturbation in Marine Soft-Bottom Environments," *Journal of Marine Research*, Vol 39, pp 767-790.

Bricelj, Malouf, and de Quillfeldt 1984

Bricelj, V. M., Malouf, R. E., and de Quillfeldt, C. 1984. "Growth of Juvenile *Mercenaria* and the Effect of Suspended Bottom Sediments," *Marine Biology*, Vol 84, pp 167-173.

Briggs 1970

Briggs, R. B. 1970. *Geology and Hydrography; No. 3, Gross Physical and Biological Effects of Overboard Spoil Disposal in Upper Chesapeake Bay*, L. E. Cronin et al., ed., Natural Resources Institute, University of Maryland, College Park, MD.

Britton and Brown 1985

Britton, N., and Brown, A. 1985. *An Illustrated Flora of the Northern United States and Canada*, Vol I, II, and III, Dover Publications, New York, NY, 2,200 pp.

Brooke et al. 2000

Brooke, J., Landin, M. C., Meakins, N., and Adnitt, C. 2000. "The Restoration of Vegetation on Saltmarshes," Technical Report W208, Environment Agency, United Kingdom.

Brown and Clark 1968

Brown, C. L., and Clark, R. 1968. "Observations on Dredging and Dissolved Oxygen in a Tidal Waterway," *Water Resources Research*, Vol 4, pp 1381-1384.

Buckman and Brady 1960

Buckman, H. O., and Brady, N. G. 1960. *The Nature and Properties of Soils*, MacMillan Publishers, New York, NY.

Burke 1989

Burke, L. 1989. "Logging System Developed to Monitor Hopper Dredges," *International Dredging Review*, November/December 1989, pp 8-9.

## Burks and Engler 1978

Burks, S. A., and Engler, R. M. 1978. "Water Quality Impacts of Aquatic Dredged Material Disposal (Laboratory Investigations); Synthesis Report," Technical Report DS-78-4, U.S. Army Engineer Waterways Experiment Station, Vicksburg, MS.

## Cadet, Lee, and Sturgis 1997

Cadet, W., Lee, C. R., and Sturgis, T. C. 1997. "Manufactured Soil from Toledo Harbor Dredged Material and Organic Waste Materials," *Proceedings of the International Workshop on Dredged Material Beneficial Uses*, July 28-August 1, 1997, Baltimore, MD. M. C. Landin, ed., U.S. Army Engineer Waterways Experiment Station, Vicksburg, MS, p 23.

## Cairns 1968

Cairns, J. 1968. "Suspended Solids Standards for the Protection of Aquatic Organisms," *Purdue University Engineering Bulletin*, Vol 129, pp 16-27.

## Cargill 1983

Cargill, K. W. 1983. "Procedures for Prediction of Consolidation in Soft Fine-Grained Dredged Material," Technical Report D-83-1, U.S. Army Engineer Waterways Experiment Station, Vicksburg, MS.

## Cargill 1985

Cargill, K. W. 1985. "Mathematical Model of the Consolidation/Desiccation Process in Dredged Material," Technical Report D-85-4, U.S. Army Engineer Waterways Experiment Station, Vicksburg, MS.

## Cargill 1986

Cargill, K. W. 1986. "The Large Strain, Controlled Rate of Strain (LSCRS) Device for Consolidation Testing of Soft Fine-Grained Soils," Technical Report GL-86-13, U.S. Army Engineer Waterways Experiment Station, Vicksburg, MS.

## Carr, Ogren, and Moven 1980

Carr, A., Ogren, L., and Moven, C. 1980. "Apparent Hibernation by the Atlantic Loggerhead Turtle, *Caretta caretta*, Off Cape Canaveral, Florida, U.S.A.," *Biological Conservation*, Vol 9, pp 7-14.

## Carriker 1986

Carriker, M. R. 1986. "Influence of Suspended Particles on Biology of Oyster Larvae in Estuaries," *American Malacological Bulletin*, Special Edition No. 3, pp 41-49.

## Carriker et al. 1986

Carriker, M. R., LaSalle, M. W., Mann, R., and Pritchard, D. W. 1986. "Entrainment of Oyster Larvae by Hydraulic Cutterhead Dredging Operations: Workshop Conclusions and Recommendations," *American Malacological Bulletin*, Special Edition No. 3, pp 71-74.

EM 1110-2-5025

31 Jul 15

Carter 1986

Carter, W. R. 1986. "An Argument for Retaining Periods of Non-Dredging for the Protection of Oyster Resources in Upper Chesapeake Bay," *American Malacological Bulletin*, Special Edition No. 3, pp 5-10.

Casagrande 1948

Casagrande, A. 1948. "Classification and Identification of Soils," *Transactions of the Society of Civil Engineers*, American Society of Civil Engineers, Vol 113, pp 109-130.

Caughley 1977

Caughley, G. 1977. "Analysis of Vertebrate Populations," John Wiley and Sons, New York, NY, 234 pp.

Chaney et al. 1974

Chaney, R. L., et al. 1974. "Recommendations for Management of Potentially Toxic Elements in Agriculture and Municipal Wastes," Tractors Involved in Land Applications of Agricultural and Municipal Wastes, National Program Staff, Soil, Water and Air Sciences, Beltsville, MD.

Chang and Levings 1978

Chang, B. D., and Levings, C. D. 1978. "Effects of Burial on the Heart Cockle *Clinocardium nuttallii* and the Dungeness Crab *Cancer magister*," *Estuarine, Coastal, and Marine Science*, Vol 7, pp 409-412.

Chapman 1976

Chapman, S. B., ed. 1976. *Methods in Plant Ecology*, John Wiley and Sons, New York, NY.

Chapman 1994

Chapman, W. R. 1994. "Monitoring Performance Indicators on Leased Hydraulic Cutterhead Dredges," *Proceedings of the Second International Conference on Dredging and Dredged Material Placement*, pp. 1315-1324.

Chase 1994

Chase, D. 1994. "CDFATE User's Manual," prepared by University of Dayton, Dayton, OH, for U.S. Army Engineer Waterways Experiment Station, Vicksburg, MS.

<http://el.erdc.usace.army.mil/elmodels/pdf/cdfate.pdf>

Chasten et al. 1993

Chasten, M. A., Rosati, J. D., McCormick, J. W., and Randall, R. E. 1993. "Engineering Design Guidance for Detached Breakwaters as Shoreline Stabilization Structures," Technical Report CERC-93-19, U.S. Army Engineer Waterways Experiment Station, Vicksburg, MS.

Chen et al. 1976

Chen, K. Y., Gupta, S. K., Sycip, A. Z., Lu, J. C. S., Knezevic, M., and Choi, W.-W. 1976. "Research Study on the Effect of Dispersion, Settling, and Resedimentation on Migration of Chemical Constituents During Open-Water Disposal of Dredged Materials," Contract Report D-76-1, U.S. Army Engineer Waterways Experiment Station, Vicksburg, MS.

Chow 1964

Chow, V. T. 1964. *Handbook of Applied Hydrology*, McGraw Hill, New York.

C-K Associates, Inc. 1993

C-K Associates, Inc. 1993. "Economics and Marketing of Aquaculture in Dredged Material Containment Areas," Technical Report EL-93-19, U.S. Army Engineer Waterways Experiment Station, Vicksburg, MS.

Clarke 1994

Clarke, D. G. 1994. "Habitat Value of Offshore Dredged Material Berms for Fishery Resources," *Proceedings of the Second International Conference on Dredging and Dredged Material Placement*, November 1994, Lake Buena Vista, FL. E. C. McNair Jr., ed., American Society of Civil Engineers, New York, NY, pp 938-946.

Clarke and Lunz 1985

Clarke, D. G., and Lunz, J. D. 1985. "The Benthic Resources Assessment Technique in Theory and Practice," *Proceedings of the Ninth Annual Environmental Review Conference*, U.S. Environmental Protection Agency, Atlanta, GA.

Clarke and Miller-Way 1992

Clarke, D. G., and Miller-Way, T. 1992. "An Environmental Assessment of the Effects of Open-Water Disposal of Maintenance Dredged Material on Benthic Resources in Mobile, AL, DOTS Miscellaneous Paper D-92-1, U.S. Army Engineer Waterways Experiment Station, Vicksburg, MS.

Clarke and Wilber 2000

Clarke, D. G., and Wilber, D. H. 2000. "Assessment of Potential Impacts of Dredging Operations Due to Sediment Resuspension," *DOER Technical Notes Collection* (ERDC TN-DOER-E9), U.S. Army Engineer Research and Development Center, Vicksburg, MS. <http://el.ercd.usace.army.mil/dots/doer>

Clark, Palermo, and Sturgis 2001

Clark, D. G., Palermo, M. R., and Sturgis, T. C. 2001. "Subaqueous Cap Design: Selection of Bioturbation Profiles, Depths, and Rates," *DOER Technical Notes Collection* (ERDC TN-DOER-C21), U.S. Army Engineer Research and Development Center, Vicksburg, MS. <http://el.ercd.usace.army.mil/dots/doer>

Clarke et al. 1990

Clarke, D. G., Homziak, J., Lazor, R. L., Palermo, M. R., Banks, G. E., Benson, H. A., Johnson, B. H., Smith-Dozier, T., Revelas, G., Dardeau, M. R. 1990. "Engineering Design and Environmental Assessment of Dredged Material Overflow from Hydraulically Filled Hopper Barges in Mobile Bay, Alabama," Miscellaneous Paper D-90-4, U.S. Army Engineer Waterways Experiment Station, Vicksburg, MS.

EM 1110-2-5025

31 Jul 15

Clausner 1993

Clausner, J. E. 1993. "Water Injection Dredging Demonstration on the Upper Mississippi River," Dredging Research Technical Note DRP-3-10, U.S. Army Engineer Waterways Experiment Station, Vicksburg, MS.

Clausner 2000

Clausner, J. E. 2000. "DMSMART – Current Status and Implementation at Mobile District," *Proceedings of the Western Dredging Association Twentieth Technical Conference and Thirty-Second Annual Texas A&M Dredging Seminar*, June 25-28, 2000, Warwick, RI, pp 403-416.

Clausner and Pope 1988

Clausner, J. E., and Pope, J. 1988. "Side-scan Sonar Applications for Evaluating Coastal Structures," Technical Report CERC-88-16, U.S. Army Engineer Waterways Experiment Station, Vicksburg, MS.

Clausner et al. 1996

Clausner, J. E., Palermo, M., Banks, D., and Palmerton, J. 1996. "Potential Application of Geosynthetic Fabric Containers for Open-Water Placement of Contaminated Dredged Material," Environmental Effects of Dredging Technical Note EEDP-01-39, March 1996, U.S. Army Engineer Waterways Experiment Station, Vicksburg, MS.

Coastal Zone Resources Corporation 1976

Coastal Zone Resources Corporation. 1976. "Identification of Relevant Criteria and Survey of Potential Application Sites for Artificial Habitat Creation," Contract Report D-76-02, Vols I and II, U.S. Army Engineer Waterways Experiment Station, Vicksburg, MS.

Coastal Zone Resources Division 1978

Coastal Zone Resources Division. 1978. "Handbook for Terrestrial Wildlife Habitat Development on Dredged Material," Technical Report D-78-37, U.S. Army Engineer Waterways Experiment Station, Vicksburg, MS.

Cochran 1963

Cochran, W. G. 1963. *Sampling Techniques*, 2nd ed. John Wiley, New York.

Collins 1995

Collins, M. A. 1995. "Dredging-Induced Near-Field Resuspended Sediment Concentration and Source Strengths," Miscellaneous Paper D-95-2, Prepared by Southern Methodist University for U.S. Army Engineer Waterways Experiment Station, Vicksburg, MS.s

Conrad and Pack 1978

Conrad, E. T., and Pack, A. J. 1978. "A Methodology for Determining Land Value and Associated Benefits Created from Dredged Material Containment," Technical Report D-78-19, U.S. Army Engineer Waterways Experiment Station, Vicksburg, MS.



Courtenay, Hartig, and Loisel 1980

Courtenay, W. R., Jr., Hartig, B. C., and Loisel, G. R. 1980. "Evaluation of Fish Populations Adjacent to Borrow Areas of Beach Nourishment Project at Hallandale (Broward County), Florida; Vol 1, Ecological Evaluation of a Beach Nourishment Project at Hallandale (Broward County), Florida," Miscellaneous Paper 80-1(1), U.S. Army Engineer Coastal Engineering Research Center, Fort Belvoir, VA.

Courtenay et al. 1972

Courtenay, W. R., Jr., Herrema, D. J., Thompson, M. J., Azzinaro, W. P., and Nontifrans, J. 1972. "Ecological Monitoring of Two Beach Nourishment Projects in Broward County, Florida," *Shore and Beach*, Vol 40, pp 8-13.

Courtney et al. 1994

Courtney, C.A., Soldate, A. M., Cox, J., and Blake, J. A. 1994. "Dredged Material Dispersion and Accumulation at a Deep Ocean Disposal Site: Comparison of Monitoring Study Results and Model Predictions," *Proceedings of the Second International Conference on Dredging and Dredged Material Placement*, Vol 1, 96-102.

Cox, Maresca, and Rosati 1996

Cox, J. M., Maresca, P., and Rosati, J. 1996. "Silent Inspector Technical Manual," Technical Report DRP-96-1, U.S. Army Engineer Waterways Experiment Station, Vicksburg, MS.

Crisp 1967

Crisp, D. L. 1967. "Chemical Factors Inducing Settlement in *Crassostrea virginica* (Gmelin)," *Journal of Animal Ecology*, Vol 36, pp 329-335.

Cronin et al. 1976

Cronin, W. B., Gross, M. G., Taylor, W. R., Whaley, R. C., Boicourt, W. C., and Schubel, J. R. 1976. "Investigations of Dredging Operations – Brewerton Cut-Off Angle-Patapsco River Mouth Disposal Site," Chesapeake Bay Institute, Baltimore, MD.

Cullinane et al. 1986

Cullinane, M. J., Averett, D. E., Shafer, R. A., Male, J. W., Truitt, C. L., and Bradbury, M. R. 1986. "Guideline for Selecting Control and Treatment Options for Contaminated Dredged Material," Puget Sound Dredged Disposal Analysis, U.S. Army Engineer Waterways Experiment Station, Vicksburg, MS.

Cura et al. 1999

Cura, J. J., Heiger-Bernays, W., Bridges, T. S., and Moore, D.W. 1999. "Ecological and Human Health Risk Assessment Guidance for Aquatic Environments," DOER-4 , U.S. Army Engineer Research and Development Center, Vicksburg, MS.

<http://el.ercd.usace.army.mil/elpubs/pdf/trdoer4.pdf>

D&A Instruments 1989

D&A Instruments. 1989. "Optical Methods for Measuring Turbidity and Suspended Particles in Water, Some Notes for Users of OBS Sensors," Technote (3/89).

Dadswell, Melvin, and Williams 1983

Dadswell, M. J., Melvin, G. D., and Williams, P. J. 1983. "Effect of Turbidity on the Temporal and Spatial Utilization of the Inner Bay of Fundy by American Shad (*Alosa sapidissima*) (Pisces: Clupeidae) and Its Relationship to Local Fisheries," *Canadian Journal of Fisheries and Aquatic Sciences*, Vol 40, pp 322-330.

Danek et al. 1977

Danek, L. J., Alther, G. R., Paily, P. O., Johnson, R. G., deLibero, F., Yohn, J. F., and Lovorn, F. T. 1977. "Aquatic Disposal Field Investigations, Ashtabula River Disposal Site, Ohio; Appendix B: Investigation of the Hydraulic Regime and Physical Nature of Bottom Sedimentation," Technical Report D-77-42, prepared by Yale University, under contract to U.S. Army Engineer Waterways Experiment Station, Vicksburg, MS.

d'Angremond et al. 1978

d'Angremond, K., Brakel, J., Hoekstra, A. J., Kleinbloesem, W. C. H., Nederlof, L., and Nekker, J. de. 1978. "Assessment of Certain European Dredging Practices and Dredged Material Containment and Reclamation Methods," Technical Report D-78-58, U.S. Army Engineer Waterways Experiment Station, Vicksburg, MS.

d'Angremond, de Jong, and de Waard 1984

d'Angremond, K., de Jong, A. J., and de Waard, C. P. 1984. "Dredging of Polluted Sediment in the First Petroleum Harbor, Rotterdam," *Proceedings of the Third United States-Netherlands Experts Meeting*, Savannah, GA.

Davies et al. 2005

Davies, M. H., MacDonald, N. J., Demirbilek, Z., Smith, S. J., Zundel, Z. K., and Jones, R. D. 2005. "Particle Tracking Model (PTM) II: Overview of features and capabilities," *DOER Technical Notes Collection* (ERDC TN-DOER-D5), U.S. Army Engineer Research and Development Center, Vicksburg, MS. <http://el.ercd.usace.army.mil/elpubs/pdf/doerd5.pdf>

Davis 1960

Davis, H. C. 1960. "Effects of Turbidity-Producing Materials in Sea Water on Eggs and Larvae of the Clam (*Venus (Mercenaria) mercenaria*)," *Biological Bulletin*, Vol 118, pp 48-54.

Davis and Hidu 1969

Davis, H. C., and Hidu, H. 1969. "Effects of Turbidity-Producing Substances in Sea Water on Eggs and Larvae of Three Genera of Bivalve Mollusks," *Veliger*, Vol I 1, pp 316-323.

Davis and Landin 1997

Davis, J. E., and Landin, M. C. 1997. "Proceedings of the National Workshop on Geotextile Tube Applications," Technical Report WRP-RE-17, U.S. Army Engineer Waterways Experiment Station, Vicksburg, MS. <http://el.ercd.usace.army.mil/wetlands/pdfs/wrpre17.pdf>

Deaner 1973

Deaner, D. G. 1973. "Effect of Chlorine on Fluorescent Dyes," *Journal of the Water Pollution Control Federation*, Vol 45, No. 3, pp 507-514.

deBree 1977

deBree, S. E. M. 1977. "The Loading of Hopper Dredgers," *Ports and Dredging and Oil Report* No. 92, pp 4-8.

Demirbilek et al. 2005a

Demirbilek, Z., Smith, J. S., Zundel, A. K., Jones, R. D., MacDonald, N. J., and Davies, M. E. 2005a. "Particle Tracking Model (PTM) in the SMS: I. Graphical interface," *Dredging Operations and Engineering Research Technical Notes Collection* (ERDC TN-DOER-D4), U.S. Army Engineer Research and Development Center, Vicksburg, MS. <http://el.ercd.usace.army.mil/elpubs/pdf/doerd4.pdf>

Demirbilek et al. 2005b

Demirbilek, Z., Smith, S. J., Zundel, A. K., Jones, R. D., McDonald, N. J., and Davies, M. E. 2005b. "Particle Tracking Model (PTM) in the SMS: III. Tutorial with examples," *Dredging Operations and Engineering Research Technical Notes Collection* (ERDC TN-DOER-D6), U.S. Army Engineer Research and Development Center, Vicksburg, MS. <http://el.ercd.usace.army.mil/elpubs/pdf/doerd6.pdf>

Demirbilek et al. 2012a

Demirbilek, Z., Lackey, T.C. and Zundel, A. K. 2012a. "Particle Tracking Model Data Analysis Tools—Part 1: Capabilities in SMS." *Dredging Operations and Engineering Research Technical Notes Collection* (ERDC TN-DOER-D15), U.S. Army Engineer Research & Development Center, Vicksburg, MS. <http://el.ercd.usace.army.mil/elpubs/pdf/doerd15.pdf>

Demirbilek et al. 2012b

Demirbilek, Z., Lackey, T.C. and Zundel, A. K. 2012b. "Particle Tracking Model Data Analysis Tools—Part 2: Case Study." *Dredging Operations and Engineering Research Technical Notes Collection* (ERDC TN-DOER-D16), U.S. Army Engineer Research & Development Center, Vicksburg, MS. <http://el.ercd.usace.army.mil/elpubs/pdf/doerd16.pdf>

De Renzo 1978

De Renzo, D. J. 1978. *Nitrogen Control and Phosphorous Removal in Sewage Treatment*. Noyes Data Corporation. Park Ridge, New Jersey.

Diaz and Boesch 1977

Diaz, R. J., and Boesch, D. F. 1977. "Impact of Fluid Mud Dredged Material on Benthic Communities of the Tidal James River, Virginia," *Technical Report D-77-45*, U.S. Army Engineer Waterways Experiment Station, Vicksburg, MS. <http://el.ercd.usace.army.mil/elpubs/pdf/trd77-45.pdf>

EM 1110-2-5025

31 Jul 15

Dickerson et al. 2004

Dickerson, D., Wolters, M., Theriot, C., and Slay, C. 2004. "Dredging Impacts on Sea Turtles in the Southeastern USA: A Historical Review of Protection," *Proceedings of the Seventeenth World Dredging Conference*, Hamburg, Germany.

DiGeorge and Herbich 1978

DiGeorge, III, F. P., and Herbich, J. B. 1978. "Laboratory Determination of Bulking Factors for Texas Coastal Fine-Grained Materials," Center for Dredging Studies, Texas A&M University, College Station, TX.

Doerr and Landin 1983

Doerr, T. B., and Landin, M. C. 1983. "Vegetative Stabilization of Training Areas of Selected United States Military Reservations," Contract Report furnished to U.S. Army Engineer Construction Engineering Research Center, Vols I and II, Champaign, IL, U.S. Army Engineer Waterways Experiment Station, Vicksburg, MS.

Dortch et al. 1990

Dortch, M. S., Hales, L. Z., Letter, J. V., and McAnally, W. H., Jr. 1990. "Methods of Determining the Long-Term Fate of Dredged Material for Aquatic Disposal Sites," Technical Report D-90-1, U.S. Army Engineer Waterways Experiment Station, Vicksburg, MS.

Dovel 1970

Dovel, W. L. 1970. "Fish Eggs and Larvae," Chesapeake Bay Laboratory, *Gross Physical and Biological Effects of Overboard Spoil Disposal in Upper Chesapeake Bay*, Natural Resources Institute Special Report 3, University of Maryland, Solomons, MD, pp 42-49.

Duarte, Joseph, and Satterlee 1995

Duarte, F., Joseph, J., and Satterlee, G. 1995. "Construction of Geocontainer and Geobag Contraction Dikes to Eliminate Dredging at Red Eye Crossing," *Proceedings of Ports '95*, ASCE, New York, NY.

Earhart, Clarke, and Shipley 1988

Earhart, G., Clarke, D., and Shipley, J. 1988. "Beneficial Uses of Dredged Material in Shallow Coastal Waters; Chesapeake Bay Demonstrations," Information Exchange Bulletin D-88-6, U.S. Army Engineer Waterways Experiment Station, Vicksburg, MS.

Eckert, Giles, and Smith 1978

Eckert, J. W., Giles, M. L., and Smith, G. M. 1978. "Design Concepts for In-Water Containment Structures for Marsh Habitat Development," Technical Report D-78-31, U.S. Army Engineer Waterways Experiment Station, Vicksburg, MS. <http://el.ercd.usace.army.mil/elpubs/pdf/trd78-31.pdf>

Eisler 1985a

Eisler, R. 1985a. "Mirex Hazards to Fish, Wildlife, and Invertebrates: A Synoptic Review," U.S. Fish and Wildlife Service Biological Report 85(1. 1).

Eisler 1985b

Eisler, R. 1985b. "Cadmium Hazards to Fish, Wildlife, and Invertebrates: A Synoptic Review," U.S. Fish and Wildlife Service Biological Report 85(1.2).

Eisler 1985c

Eisler, R. 1985c. "Carbofuran Hazards to Fish, Wildlife, and Invertebrates: A Synoptic Review," U.S. Fish and Wildlife Service Biological Report 85(1.3).

Eisler 1985d

Eisler, R. 1985d. "Selenium Hazards to Fish, Wildlife, and Invertebrates: A Synoptic Review," U.S. Fish and Wildlife Service Biological Report 85(1.5).

Eisler 1986a

Eisler, R. 1986a. "Chromium Hazards to Fish, Wildlife, and Invertebrates: A Synoptic Review," U.S. Fish and Wildlife Service Biological Report 85(i.6).

Eisler 1986b

Eisler, R. 1986b. "Polychlorinated Biphenyl Hazards to Fish, Wildlife, and Invertebrates: A Synoptic Review," U.S. Fish and Wildlife Service Biological Report 85(1.7).

Eisler 1986c

Eisler, R. 1986c. "Dioxin Hazards to Fish, Wildlife, and Invertebrates: A Synoptic Review," U.S. Fish and Wildlife Service Biological Report 85(1.8).

Eisler 1986d

Eisler, R. 1986d. "Diazinon Hazards to Fish, Wildlife, and Invertebrates: A Synoptic Review," U.S. Fish and Wildlife Service Biological Report 85(1.9).

Eisler 1987a

Eisler, R. 1987a. "Mercury Hazards to Fish, Wildlife, and Invertebrates: A Synoptic Review," U.S. Fish and Wildlife Service Biological Report 85(1.10).

Eisler 1987b

Eisler, R. 1987b. "Polycyclic Aromatic Hydrocarbon Hazards to Fish, Wildlife, and Invertebrates: A Synoptic Review," U.S. Fish and Wildlife Service Biological Report 85(1.11).

Eisler 1988a

Eisler, R. 1988a. "Arsenic Hazards to Fish, Wildlife, and Invertebrates: A Synoptic Review," U.S. Fish and Wildlife Service Biological Report 85(1.12).

Eisler 1988b

Eisler, R. 1988b. "Chlorpyrifos Hazards to Fish, Wildlife, and Invertebrates: A Synoptic Review," U.S. Fish and Wildlife Service Biological Report 85(1.13).

EM 1110-2-5025

31 Jul 15

Eisler 1988c

Eisler, R. 1988c. "Lead Hazards to Fish, Wildlife, and Invertebrates: A Synoptic Review," U.S. Fish and Wildlife Service Biological Report 85(1.14).

Eisler and Jacknow 1985

Eisler, R., and Jacknow, J. 1985. "Toxaphene Hazards to Fish, Wildlife, and Invertebrates: A Synoptic Review," U.S. Fish and Wildlife Service Biological Report 85(1.4).

Emery 1969

Emery, K. O. 1969. "The Ocean; A Scientific American Book." W. H. Freeman and Co., San Francisco, CA, pp 39-52.

Engler et al. 1988

Engler, R. M., Wright, T., Lee, C. L., and Dillon, T. M. 1988. "Corps of Engineers' Procedures and Policies on Dredging and Dredged Material Disposal (The Federal Standard)," Environmental Effects of Dredging Technical Note EEDP-048, U.S. Army Engineer Waterways Experiment Station, Vicksburg, MS.

Environmental Laboratory 1976

Environmental Laboratory. 1976. "Ecological Evaluation of Proposed Discharge of Dredged and Fill Material into Navigable Waters" (Interim guidance for implementation of Section 404[b][1] of PL 92-500), Technical Report D-76-17, U.S. Army Engineer Waterways Experiment Station, Vicksburg, MS.

Environmental Laboratory 1978

Environmental Laboratory. 1978. "Wetland Habitat Development with Dredged Material: Engineering and Plant Propagation," Technical Report DS-78-16, U.S. Army Engineer Waterways Experiment Station, Vicksburg, MS. <http://el.erd.c.usace.army.mil/dots/pdfs/ds78-16/ds78-16a.pdf>

Environmental Laboratory 1985

Environmental Laboratory. 1985. "Field Guide for Low-Maintenance Vegetation Establishment and Management," Instruction Report R-86-02, U.S. Army Engineer Waterways Experiment Station, Vicksburg, MS.

Environmental Security Technology Certification Program/U.S. Army Corps of Engineers (in preparation)

Environmental Security Technology Certification Program/U.S. Army Corps of Engineers (in preparation). "Guidance for Dredging in Munitions and Explosives of Concern (MEC)-Contaminated Sediments," Washington DC.

Ezell 1978

Ezell, W. B., Jr., ed. 1978. "An Investigation of Physical, Chemical, and/or Biological Control of Mosquitos in Dredged Material Disposal Areas," Technical Report D-78-48, U.S. Army Engineer Waterways Experiment Station, Vicksburg, MS. <http://el.erd.c.usace.army.mil/elpubs/pdf/trd78-48/cover.pdf>

Farr 1977

Farr, J. 1977. "Impairment of Antipredator or Behavior in Palaemonetes pugio by Exposure to Sub-lethal Doses of Parathion," *Transactions of the American Fisheries Society*, Vol 106, pp 287-290.

Farr 1978

Farr, J. 1978. "The Effect of Methyl Parathion on Predation Choice of Two Estuarine Prey Species," *Transactions of the American Fisheries Society*, Vol 107, pp 87-91.

Federal Highway Administration

Federal Highway Administration. Undated. "Geotextile Engineering Manual," National Highway Institute, Washington, DC.

Federal Interagency Committee for Wetland Delineation 1989

Federal Interagency Committee for Wetland Delineation. 1989. "Federal Manual for Identifying and Delineating Jurisdictional Wetlands," Cooperative Technical Publication, U.S. Army Corps of Engineers, Washington, DC

*Federal Register* 1990

*Federal Register*. 24 Dec 1990, Vol 45, No. 249, Section 230.6, U.S. National Archives and Records Administration, Washington, DC, p. 85347.

Fennessy and Mitsch 1989

Fennessy, S. and W.J. Mitsch. 1989. Treating coal mine drainage with an artificial wetland. *Research J. Water Pollution Control Federation* 61:1691-1701.

Feuerstein and Selleck 1963

Feuerstein, D. L., and Selleck, R. E. 1963. "Fluorescent Tracers for Dispersion Measurements," *Journal of the Sanitary Engineering Division*, American Society of Civil Engineers, Vol 89, No. SA4, pp 1-21.

Flemer et al. 1967

Flemer, D. A., Dovel, W. L., Pfitzenmeyer, H. T., and Ritchie, D. E. 1967. "Spoil Disposal in Upper Chesapeake Bay; 11. Preliminary Analysis of Biological Effects," Proceedings of the National Symposium on Estuarine Pollution, Stanford University, pp 152-187.

Folsom and Lee 1985

Folsom, B. L., and Lee, C. R. 1985. "Plant Bioassay of Dredged Material," *Environmental Effects of Dredging Technical Notes* EEDP-02-1, U.S. Army Engineer Waterways Experiment Station, Vicksburg, MS. <http://el.erdc.usace.army.mil/dots/pdfs/eedp02-1.pdf>

Fonseca 1987

Fonseca, M. S. 1987. "Use of Seagrass Transplanting for Habitat Development on Dredged Material," *Proceedings of the First Interagency Workshop on Beneficial Uses of Dredged Material*, October 1986, Pensacola, FL, Technical Report D-87-01, 1987, U.S. Army Engineer Waterways Experiment Station, Vicksburg, MS, pp 145-150.



Fonseca et al. 1985

Fonseca, M. S., Kenworthy, W. J., Thayer, G. W., Heller, D. Y., and Cheap, K. M. 1985. "Transplanting of the seagrass *Zostera marina* and *Halodule wrightii* for Sediment Stabilization and Habitat Development on the East Coast of the United States," Technical Report EL-85-09, U.S. Army Engineer Waterways Experiment Station, Vicksburg, MS.

Francingues and Mathis 1989

Francingues, N. R., and Mathis, B. 1989. "Long-Term Management Strategy for the Corps Navigation Dredging Program," *Proceedings from WODCON XII*, May 2-5, 1989.

Francingues and Palermo 2005

Francingues, N. R., and Palermo, M. R. 2005. "Silt Curtains as a Dredging Project Management Practice," *DOER Technical Notes Collection* ERDC TN-DOER-E21, U.S. Army Engineer Research and Development Center, Vicksburg, MS. <http://el.erdc.usace.army.mil/elpubs/pdf/doere21.pdf>

Francingues, Averett, and Otis 1988

Francingues, N. R., Averett, D. E., and Otis, M. J. 1988. "New Bedford Harbor Superfund Project, Acushnet River Estuary Engineering Feasibility Study of Dredging and Dredged Material Disposal Alternatives, Report 1, Study Overview," Technical Report EL-88-15, Report 1, U.S. Army Engineer Waterways Experiment Station, Vicksburg, MS. <http://el.erdc.usace.army.mil/elpubs/pdf/trel88-15-3.pdf>

Francingues et al. 1985

Francingues, N. R., Palermo, M. R., Lee, C. R., and Peddicord, R. K. 1985. "Management Strategy for Disposal of Dredged Material: Contaminant Testing and Controls," Miscellaneous Paper D-85-1, U.S. Army Engineer Waterways Experiment Station, Vicksburg, MS. <http://el.erdc.usace.army.mil/dots/pdfs/mpd85-1.pdf>

Fredette et al. 1990a

Fredette, T. J., Nelson, D. A., Clausner, J. E., and Anders, F. J. 1990a. "Guidelines for Physical and Biological Monitoring of Aquatic Dredged Material Disposal Sites," Technical Report D-90-12, U.S. Army Engineer Waterways Experiment Station, Vicksburg, MS. <http://el.erdc.usace.army.mil/dots/pdfs/trd90-12.pdf>

Fredette et al. 1990b

Fredette, T. J., Nelson, D. A., Miller-Way, T., Adair, J. A., Sotler, V. A., Clausner, J. E., Hands, E. B., and Anders, F. J. 1990b. "Selected Tools and Techniques for Physical and Biological Monitoring of Aquatic Dredged Material Disposal Sites," Technical Report D-90-11, U.S. Army Engineer Waterways Experiment Station, Vicksburg, MS. <http://el.erdc.usace.army.mil/dots/pdfs/trd90-11.pdf>



Fredette et al. 1999

Fredette, T. J., Jackson, P. E., Murray, P. M., Hadden, D. A., and Bell, D. L. 1999. "Preliminary Monitoring Results from the Phase II Boston Harbor Confined Aquatic Disposal Cells." *Proceedings of the Western Dredging Association, Nineteenth Technical Conference and Twenty-first Texas A&M Dredging Seminar*, May 15-18, 1999, Louisville, KY. pp 255-275.

Fredette et al. 2000

Fredette, T. J., Jackson, P. E., Demos, C. J., Hadden, D. A., Wolf, S. H., Nowak, Jr., T. A., and DeAngelo, E. 2000. "The Boston Harbor Navigation Improvement Project CAD Cells: Recommendations for Future Projects Based on Field Experience and Monitoring," *Proceedings of the Western Dredging Association Twentieth Technical Conference and Thirty-Second Annual Texas A&M Dredging Seminar*, June 25-28, 2000, Warwick, RI, pp 291-302.

Frey, Basan, and Scott 1973

Frey, R. W., Basan, P. B., and Scott, R. M. 1973. "Techniques for Sampling Salt Marsh Benthos and Burrows," *American Midland Naturalist*, Vol. 89, No. 1, pp 228-234.

Galtsoff 1964

Galtsoff, P. S. 1964. "The American Oyster *Crassostrea virginica* Gmelin," *Fishery Bulletin*, Vol 64, pp 1-480.

Gambrell, Kahlid, and Patrick 1978

Gambrell, R. P., Kahlid, R. A., and Patrick, W. H., Jr. 1978. "Disposal Alternatives for Contaminated Dredged Material as a Management Tool to Minimize Adverse Environmental Effects," Technical Report DS-78-08, U.S. Army Engineer Waterways Experiment Station, Vicksburg, MS. <http://el.erdc.usace.army.mil/elpubs/pdf/ds78-8/cover.pdf>

Garbarino et al. 1994

Garbarino, S. D., Blama, R. N., Landin, M. C., Maynard, S. R., and Patin, T. R. 1994. "Environmental Restoration and Enhancement using Dredged Material in Chesapeake Bay, Maryland," *Dredging '94, Proceedings of the Second International Conference on Dredging and Dredged Material Placement*, November 1994, Lake Buena Vista, FL, E. C. McNair, Jr., ed., ASCE, New York, NY, pp 384-394.

Germano and Cary 2005

Germano, J. D., and Cary, D. (2005). "Rates and Effects of Sedimentation in the Context of Dredging and dredged material placement," DOER Technical Notes Collection (ERDC TN-DOER-E19), U.S. Army Engineer Research and Development Center, Vicksburg, MS. <http://el.erdc.usace.army.mil/elpubs/pdf/doere19.pdf>

Gibson, England, and Hussey 1967

Gibson, R. E., England, G. L., and Hussey, M. J. L. 1967. "The Theory of One-Dimensional Consolidation of Saturated Clays, II. Finite Non-Linear Consolidation of Thin Homogeneous Layers," *Geotechnique*, Vol 17, No. 3, pp 261-273.

EM 1110-2-5025

31 Jul 15

Glude 1954

Glude, U. B. 1954. "Survival of Soft-Shell Clams, *Mya arenaria*, Buried at Various Depths," Research Bulletin No. 22, Maine Department of Sea and Shore and Fisheries, Bangor, ME.

Godfrey and Wooten 1979

Godfrey, R. K., and Wooten, J. W. 1979. "Aquatic and Wetland Plants of Southeastern United States, Vol I and II," University of Georgia Press, Athens, GA, 1,500 pp.

Gordon 1973

Gordon, R. B. 1973. "Turbidity and Siltation Caused by Dredging in Coastal Waters," prepared for the United Illuminating Company by Yale University, Department of Geology and Geophysics, New Haven, CT.

Green 1979

Green, R. H. 1979. *Sampling Design and Statistical Methods for Environmental Biologists*, John Wiley, New York.

Green and Rula 1977

Green, C. E., and Rula, A. A. 1977. "Low-Ground-Pressure Construction Equipment for Use in Dredged Material Containment Area Operation and Maintenance - Equipment Inventory," Technical Report D-77-1, U.S. Army Engineer Waterways Experiment Station, Vicksburg, MS. <http://el.erdc.usace.army.mil/elpubs/pdf/trd77-1/cover.pdf>

Grieg-Smith 1964

Grieg-Smith, P. 1964. *Quantitative Plant Ecology*, Butterworth and Company, London.

Grimwood 1983

Grimwood, C. 1983. "Effects of Dredging on Adjacent Waters," *ASCE Journal of Environmental Engineering*, American Society of Civil Engineers, Vol 109, No.1.

Gupta et al. 1978

Gupta, S. C., Larson, W. E., Gast, R. G., Combs, S. M., and Dowdy, R. H. 1978. "The Agricultural Value of Dredged Material," Technical Report D-78-36, U.S. Army Engineer Waterways Experiment Station, Vicksburg, MS. <http://el.erdc.usace.army.mil/elpubs/pdf/trd78-36/cover.pdf>

Gysel and Lyon 1980

Gysel, L. W., and Lyon, L. J. 1980. "Habitat Analysis and Evaluation," *Wildlife Management Techniques Manual*, The Wildlife Society, Washington, DC, pp 305-328.

Hackney et al. 1996

Hackney, C. T., Posey, M. H., Ross, S. W., and Norris, A. R. 1996. "A Review and Synthesis of Data on Surf Zone Fishes and Invertebrates in the South Atlantic Bight and the Potential Impacts from Beach Renourishment." Prepared by the University of North Carolina at Wilmington and the North Carolina National Estuarine Research Reserve for U.S. Army Corps of Engineers, Wilmington, NC.

Haliburton 1978

Haliburton, T. A. 1978. "Guidelines for Dewatering/Densifying Confined Dredged Material," Technical Report DS-78-11, U.S. Army Engineer Waterways Experiment Station, Vicksburg, MS. <http://el.erdc.usace.army.mil/elpubs/pdf/ds78-11/ds78-11.pdf>

Haliburton et al. 1977

Haliburton, T. A., Durham, G. N., Brown, K. W., Peters, R. E., and Dulaney, T. B., Jr. 1977. "Effects of Mechanical Agitation on Drying Rate of Fine-Grained Dredged Material," Technical Report D-77-10, U.S. Army Engineer Waterways Experiment Station, Vicksburg, MS. <http://el.erdc.usace.army.mil/elpubs/pdf/trd77-10.pdf>

Haliburton et al. 2002

Haliburton, T. A., Palermo, M. R., Chamlee, R. M., West, A. W., Spotts, J. W., Lytton, R. L., Batz, J. L., Willoughby, W. E., Hammer, D. P., Douglas, F. A., O'Bannon, D. E., and Stout, J. P. 2002. "Dredged Material Dewatering Field Demonstrations at Upper Polecat Bay Disposal Area, Mobile Alabama," Technical Report D-78-59, U.S. Army Engineer Research and Development Center, Vicksburg, MS. <http://el.erdc.usace.army.mil/elpubs/pdf/trd78-59.pdf>

Hammer 1981

Hammer, D. P. 1981. "Evaluation of Underdrainage Techniques for the Densification of Fine-Grained Dredged Material," Technical Report EL-81-3, U.S. Army Engineer Waterways Experiment Station, Vicksburg, MS. <http://el.erdc.usace.army.mil/elpubs/pdf/trd78-59.pdf>

Hammer and Blackburn 1977

Hammer, D. P., and Blackburn, E. D. 1977. "Design and Construction of Retaining Dikes for Containment of Dredged Material," Technical Report D-77-9, U.S. Army Engineer Waterways Experiment Station, Vicksburg, MS. <http://el.erdc.usace.army.mil/elpubs/pdf/trd78-59.pdf>

Hands 1994

Hands, E. B. 1994. "Analysis of Dredged Material Placed in Open Water," *Proceedings of the Second International Conference on Dredging and Dredged Material Placement*, November 1994, Lake Buena Vista, FL. E. C. McNair, Jr., ed., American Society of Civil Engineers, New York, NY, pp 18-27.

Harper 1973

Harper, D. E., Jr. 1973. "Effects of Siltation and Turbidity on the Benthos and Nekton, Appendix DS," *Environmental Impact Assessment of Shell Dredging in San Antonio Bay, Texas*, Vol 5, Texas A&M Research Foundation, College Station, TX, pp 114-123.

Harrison and Chisholm 1974

Harrison, J. E., and Chisholm, L. C. 1974. "Identification of Objectionable Environmental Conditions and Issues Associated with Confined Disposal Areas," Contract Report D-74-4, NTIS No. AD-A000895, U.S. Army Engineer Waterways Experiment Station, Vicksburg, MS. <http://el.erdc.usace.army.mil/elpubs/pdf/crd74-4/cover.pdf>

EM 1110-2-5025

31 Jul 15

Harrison et al. 1976

Harrison, W., Dravnieks, A., Zussman, R., and Goltz, R. 1976. "Abatement of Malodors at Confined Dredged Material Disposal Sites," Contract Report D-76-9, U.S. Army Engineer Waterways Experiment Station, Vicksburg, MS. <http://el.erdc.usace.army.mil/elpubs/pdf/crd76-9.pdf>

Hartley 1988

Hartley, D. R. 1988. "Wetland and Upland Wildlife Habitat Development on Dredged Material Disposal Areas on the Tennessee-Tombigbee Waterway," *Proceedings of the Inland Waterways Beneficial Uses of Dredged Material Workshop*, October 1987, St. Paul, MN, Technical Report D-88-8, U.S. Army Engineer Waterways Experiment Station, Vicksburg, MS, pp 129-134.

Havis 1988a

Havis, R. N. 1988a. "A Preliminary Evaluation of Contaminant Release at the Point of Dredging," Environmental Effects of Dredging Program Technical Note EEDP-09-3, U.S. Army Engineer Waterways Experiment Station, Vicksburg, MS. <http://el.erdc.usace.army.mil/dots/pdfs/eedp09-3.pdf>

Havis 1988b

Havis, R. N. 1988b. "Sediment Resuspension by Selected Dredges," Environmental Effects of Dredging Technical Note EEDP-09-2, U.S. Army Engineer Waterways Experiment Station, Vicksburg, MS. <http://el.erdc.usace.army.mil/dots/pdfs/eedp09-2.pdf>

Havis 1994

Havis, R. N. 1994. "Mixing Zone Simulation Model for Dredge Overflow and Discharge into Inland and Coastal Waters," U.S. Army Engineer Waterways Experiment Station, Vicksburg, MS.

Hayden 1978

Hayden, M. L. 1978. "Prediction of Volumetric Requirements for Dredged Material Containment Areas," Technical Report D-78-41, U.S. Army Engineer Waterways Experiment Station, Vicksburg, MS. <http://el.erdc.usace.army.mil/elpubs/pdf/trd78-41/cover.pdf>

Hayes 1986

Hayes, D. F. 1986. "Guide to Selecting a Dredge for Minimum Resuspension of Sediment," Environmental Effects of Dredging Program Technical Note EEDP-09-1, U.S. Army Engineer Waterways Experiment Station, Vicksburg, MS. <http://el.erdc.usace.army.mil/dots/pdfs/eedp09-1.pdf>

Hayes, Borrowman, and Welp 2000

Hayes, D., Borrowman, T., and Welp, T. 2000. "Near-field Turbidity Observations during Boston Harbor Bucket Comparison Study," *Proceedings of the Western Dredging Association Twentieth Technical Conference and Thirty-Second Annual Texas A&M Dredging Seminar*, June 25-28, 2000, Warwick, RI.

Hayes, McLellan, and Truitt 1988

Hayes, D. F., McLellan, T. N., and Truitt, C. L. 1988. "Demonstrations of Innovative and Conventional Dredging Equipment at Calumet Harbor, Illinois," Miscellaneous Paper EL-88-1, U.S. Army Engineer Waterways Experiment Station, Vicksburg, MS. <http://el.ercd.usace.army.mil/elpubs/pdf/mpel88-1.pdf>

Hayes, Raymond, and McLellan 1984

Hayes, D. F., Raymond, G. L., and McLellan, T. N. 1984. "Sediment Resuspension from Dredging Activities," *Dredging and Dredged Material Disposal*, Proceedings of the Conference Dredging '84, American Society of Civil Engineers, pp 72- 82.

Hayes et al. 2000

Hayes, D. F., Olin, T. J., Fischenich, J. C., and Palermo, M. R. 2000. "Wetlands Engineering Handbook," ERDC/EL TR-WRP-RE-21, U.S. Army Engineer Research and Development Center, Vicksburg, MS. <http://el.ercd.usace.army.mil/wetlands/pdfs/wrpre21/wrpre21.pdf>

Headland et al. 2002

Headland, J., Kotulak, P., Alfageme, S., and Wisemiller, B. 2002. "Dredged Material Management Alternatives: Islands, Sub-aqueous Placement Cells and Sedimentation Minimization." *Proceedings of the Third Specialty Conference on Dredging and Dredged Material Disposal - Dredging '02 - Key Technologies for Global Prosperity*, 5-8 May 2002, Orlando, FL. Stephen Garbaciak, Jr., ed., American Society of Civil Engineers.

Headquarters, U.S. Army Corps of Engineers 2005

Headquarters, U.S. Army Corps of Engineers. 2005. "Army Corps of Engineers Report to Congress Hopper Dredges, 3 June 2005," Washington, DC.

Herbich 1992

Herbich, J. B., ed. 1992. *Handbook of Dredging Engineering*, 1<sup>st</sup> Edition, McGraw-Hill, New York.

Herbich 2000

Herbich, J. B., ed. 2000. *Handbook of Dredging Engineering*, McGraw-Hill, New York.

Herbich and Brahme 1991

Herbich, J. B., and Brahme, S. B. 1991. "Literature Review and Technical Evaluation of Sediment Resuspension During Dredging," Contract Report HL-91-1, Center for Dredging Studies, College Station, TX. <http://el.ercd.usace.army.mil/e2d2/pdfs/crhl91-1.pdf>

Herbich et al. 1992

Herbich, J. B., Lee, J. Y., Trivedi, D. R., Wilkinson, G., and De Hert, D. O. 1992. "Survey and Evaluation of Production Meter Instrumentation and Uses," Contract Report DACW-39-89-K-0003, prepared by Texas Engineering Experiment Station, College Station, TX, for U.S. Army Engineer Waterways Experiment Station, Vicksburg, MS.

EM 1110-2-5025

31 Jul 15

Hidu 1969

Hidu, H. 1969. "Gregarious Settling in the American Oyster *Crassostrea virginica* Gmelin," *Chesapeake Science*, Vol 10, pp 85-92.

Hobson 1979

Hobson, R. D. 1979. "Definition and Uses of the Phi Grade Scale," Coastal Engineering Technical Aid No. 79-7, U.S. Army Engineer Waterways Experiment Station, Vicksburg, MS.

Holland, Chambers, and Blackman 1980

Holland, T. H., Chambers, L. R., and Blackman, R. R. 1980. "Effects of Dredging and Filling for Beach Erosion Control on Fishes in the Vicinity of Lido Key, Florida," prepared for U.S. Army Engineer District, Jacksonville, Jacksonville, FL.

Holling 1973

Holling, C. S. 1973. "Resilience and Stability in Ecological Systems," *Annual Review of Ecology and Systematics*, Vol 4, pp 1-23.

Homziak 1985

Homziak, L. 1985. "Does Succession Occur in Estuarine Soft Substrates? Seasonal Patterns of Colonization and Mechanisms of Species Replacement in Experimentally Defaunated Sediments," Dissertation, University of North Carolina, Chapel Hill, NC.

Homziak, Veal, and Hayes 1993

Homziak, J., Veal, C. D., and Hayes, D. F. 1993. "Design and Construction of Aquaculture Facilities in Dredged Material Containment Areas," Technical Report EL-93-11, U.S. Army Engineer Waterways Experiment Station, Vicksburg, MS. <http://el.ercd.usace.army.mil/elpubs/pdf/trel93-11.pdf>

Hoover et al. 2005

Hoover, J. J., Killgore, K. J., Clarke, D. G., Smith, H., Turnage, A., and Beard, J. (2005). "Paddlefish and sturgeon entrainment by dredges: Swimming performance as an indicator of risk," DOER Technical Notes Collection (ERDC TN-DOER-E22), U.S. Army Engineer Research and Development Center, Vicksburg, MS. <http://el.ercd.usace.army.mil/elpubs/pdf/doere22.pdf>

Hough 1957

Hough, B. K. 1957. *Basic Soils Engineering*, Ronald Press, New York, NY.

Hough 1958

Hough, J. L. 1958. "Geology of the Great Lakes," University of Illinois, Urbana, 1958.

Houston 1996

Houston, J. R. 1996. "International Tourism and U. S. Beaches," *Shore and Beach*, Vol 64.

Houston, LaSalle, and Lunz 1989

Houston, L. I., LaSalle, M. W., and Lunz, J. D. 1989. "Impacts of Dredging on Dissolved Oxygen and Other Water Quality Parameters in Haverstraw Bay," Proceedings of the Seventh Symposium on Hudson River Ecology, Hudson River Environmental Society, Inc., New Paltz, NY.

Hudson 1981

Hudson, H. E., Jr. 1981. *Water Clarification Processes Practical Design and Evaluation*, Van Nostrand Reinhold, New York.

Hunt et al. 1978

Hunt, L. J., Landin, M. C., Ford, A. W., and Wells, B. R. 1978. "Upland Habitat Development with Dredged Material: Engineering and Plant Propagation," Technical Report DS-78-17, U.S. Army Engineer Waterways Experiment Station, Vicksburg, MS. <http://el.erdc.usace.army.mil/elpubs/pdf/ds78-17/ds78-17a.pdf>

Huston 1970

Huston, J. 1970. *Hydraulic Dredging*, Cornell, Cambridge, MA.

Huston 1986

Huston, J. 1986. *Hydraulic Dredging: Principles, Equipment, Procedures, Methods*, John Huston, Inc., Corpus Christi, TX.

Huston and Huston 1976

Huston, J. W., and Huston, W. C. 1976. "Techniques for Reducing Turbidity Associated with Present Dredging Procedures and Operations," Contract Report D-76-4, U.S. Army Engineer Waterways Experiment Station, Vicksburg, MS. <http://el.erdc.usace.army.mil/elpubs/pdf/trd76-4.pdf>

Ingle 1952

Ingle, R. M. 1952. "Studies on the Effect of Dredging Operations Upon Fish and Shellfish," Technical Series No. 5, State of Florida, Board of Conservation, Tallahassee, FL.

Irish, McClung, and Lillycrop 2000

Irish, J. L., McClung, J. K., and Lillycrop, W. J. 2000. "Airborne Lidar Bathymetry: The SHOALS System," *PIANC Bulletin*, No. 103-2000, pp 43-53.

JBF Scientific Corporation 1974

JBF Scientific Corporation. 1974. "The Collection of Data on the Turbidity Associated with Sand and Gravel Mining and a Comparison to Predictions Using a Dispersion Model," Wilmington, MA.

JBF Scientific Corporation 1978

JBF Scientific Corporation. 1978. "An Analysis of the Functional Capabilities and Performance of Silt Curtains," Technical Report D-78-39, U.S. Army Engineer Waterways Experiment Station, Vicksburg, MS. <http://el.erdc.usace.army.mil/elpubs/pdf/trd78-39.pdf>



EM 1110-2-5025

31 Jul 15

Jeane and Pine 1975

Jeane, G. S., and Pine, R. E. 1975. "Environmental Effects of Dredging and Spoil Disposal," *Journal of the Water Pollution Control Federation*, Vol 47, pp 553-561.

Johanson 1977

Johanson, E. E. 1977. "Application and Performance of Silt Curtains." U.S. Army Corps of Engineers Information Exchange Bulletin, Vol. D-77-10, U.S. Army Engineer Waterways Experiment Station, Vicksburg, MS. <http://el.erdc.usace.army.mil/elpubs/pdf/trd77-10.pdf>

Johanson, Bowen, and Henry 1976

Johanson, E. E., Bowen, S. P., and Henry, G. 1976. "State-of-the-Art Survey and Evaluation of Open-Water Dredged Material Placement Methodology," Contract Report D-76-3, U.S. Army Engineer Waterways Experiment Station, Vicksburg, MS. <http://el.erdc.usace.army.mil/elpubs/pdf/trd76-3.pdf>

Johnson 1990

Johnson, B. H. 1990. "User's Guide for Models of Dredged Material Disposal in Open Water," Technical Report D-90-5, U.S. Army Engineer Waterways Experiment Station, Vicksburg, MS. <http://el.erdc.usace.army.mil/dots/pdfs/trd90-5.pdf>

Johnson 1993

Johnson, B. E. 1993. "Development and Verification of Numerical Models for Predicting the Initial Fate of Dredged Material Disposal in Open Water. Report 1, Physical Model Test of Dredged Material Disposal from a Split-Hull Barge and a Multiple Bin Vessel," Technical Report DRP-93-1, Report 1, U.S. Army Engineer Waterways Experiment Station, Vicksburg, MS.

Johnson and Schroeder 1993

Johnson, B. H. and Schroeder, P. R. 1993. "Numerical Disposal Modeling," Dredging Research Program Technical Notes DRP-1-02. U.S. Army Engineer Waterways Experiment Station, Vicksburg, MS. <http://el.erdc.usace.army.mil/elpubs/pdf/drp1-02.pdf>

Johnson and Sraders 2003

Johnson, K. D., and Sraders, G. A. 2003. "Geotechnical Investigations for Dredging Projects: A Contractors Perspective," *Proceedings of the Western Dredging Association Twenty-Third Technical Conference and Thirty-Fifth Texas A&M Dredging Seminar*, June 10-13, 2003, Chicago, IL, pp 254-263.

Johnson, Franklin, and Krebill 1984

Johnson, J. L., Franklin, J. F., and Krebill, R. G., ed. 1984. *Research Natural Areas: Baseline Monitoring and Management, Proc. Symposium in Missoula, MT*, USDA Forest Service General Technical Report INT-173, Ogden, UT.



Johnson et al. 1977

Johnson, S. J., Cunny, R. W., Perry, E. B., and Devay, L. 1977. "State-of-the-Art Applicability of Conventional Densification Techniques to Increase Disposal Area Storage Capacity," Technical Report D-77-4, U.S. Army Engineer Waterways Experiment Station, Vicksburg, MS. <http://el.erdc.usace.army.mil/elpubs/pdf/crd77-4V1/cover.pdf>

Jones 1984

Jones, G. 1984. "New Geophysical Techniques in Seabed Sand Surveys," *Dredging and Port Construction*, Vol 11, Number 6, p 25.

Jones et al. 2004

Jones, N. L., Jones, R. D., Butler, C. D., and Wallace, R. M. 2004. "A generic format for multi-dimensional models," *Proceedings World Water and Environmental Resources Congress 2004*.

Jones, Williams, and Moore 1978

Jones, R. H., Williams, R. R., and Moore, T. K. 1978. "Development and Application of Design and Operation Procedures for Coagulation of Dredged Material Slurry and Containment Area Effluent," Technical Report D-78-54, U.S. Army Engineer Waterways Experiment Station, Vicksburg, MS. <http://el.erdc.usace.army.mil/elpubs/pdf/trd78-54.pdf>

Jorgeson and Scott 1994

Jorgeson, J. D., and Scott, H. L. 1994. "An Automated System for Hopper Dredge Monitoring," Technical Report HL-94-12, U.S. Army Engineer Waterways Experiment Station, Vicksburg, MS.

Jutte, Van Dolah, and Levisen 1999a

Jutte, P. C., Van Dolah, R. F., and Levisen, M. V. 1999a. "An Environmental Monitoring Study of the Myrtle Beach Renourishment Project: Intertidal Benthic Community Assessment of Phase I—Cherry Grove to North Myrtle Beach," Final Report, prepared by the Marine Resources Division, South Carolina Department of Natural Resources for U.S. Army Corps of Engineers, Charleston, SC.

Jutte, Van Dolah, and Levisen 1999b

Jutte, P. C., Van Dolah, R. F., and Levisen, M. V. 1999b. "An Environmental Monitoring Study of the Myrtle Beach Renourishment Project: Intertidal Benthic Community Assessment of Phase II.- Myrtle Beach," Supplemental Report, prepared by the Marine Resources Division, South Carolina Department of Natural Resources for U.S. Army Corps of Engineers.

Kantor 1984

Kantor, R. A. 1984. "A Review of the Potential Environmental Effects of Dredging in New Jersey's Tidal Waters with Recommendations on Seasonal Restrictions," New Jersey Department of Environmental Protection, Trenton, NJ.

Kaplan, Welker, and Kraus 1974

Kaplan, E. H., Welker, J. R., and Kraus, M. O. 1974. "Some Effects of Dredging on Populations of Macrobenthic Organisms," *Fishery Bulletin*, Vol 72, pp 445-480.

EM 1110-2-5025

31 Jul 15

Kay 1984

Kay, S. H. 1984. "Potential for Biomagnification of Contaminants Within Marine and Fresh-water Food Webs," Technical Report D-84-7, U.S. Army Engineer Waterways Experiment Station, Vicksburg, MS. <http://el.erdc.usace.army.mil/dots/pdfs/trd84-7.pdf>

Kendall 1983

Kendall, D. R. 1983. "The Role of Physical-Chemical Factors in Structuring Subtidal Marine and Estuarine Benthos," Technical Report EL-83-2, U.S. Army Engineer Waterways Experiment Station, Vicksburg, MS.

Kendeigh 1944

Kendeigh, S. C. 1944. "Measurements of Bird Populations," *Ecological Monographs*, Vol. 14, No. 1, pp 68-106.

Kershaw 1973

Kershaw, K. A. 1973. *Quantitative and Dynamic Plant Ecology*, American Elsevier, New York.

King and Costanza 1994

King, D., and Costanza, R. 1994. "The Cost of Wetland Creation and Restoration," University of Maryland Contract Report to the Department of Energy, Washington, DC.

Kiorboe et al. 1981

Kiorboe, T., Frantsen, E., Jensen, C., and Sorensen, G. 1981. "Effects of Suspended Sediment on Development and Hatching of Herring (*Clupea harengus*) Eggs," *Estuarine, Coastal, and Shelf Science*, Vol 13, pp 107-111.

Klesch 1987

Klesch, W. L. 1987. "Long-Term Management Strategy (LTMS) for the Disposal of Dredged Material: Corps-Wide Implementation, *Environmental Effects of Dredging*, Information Exchange Bulletin Vol. D-87-4, U.S. Army Engineer Waterways Experiment Station, Vicksburg, MS.

Koba 1984

Koba, H. 1984. "Dispersion of Sediment Resuspension Caused by Dredge Operations," *Proceedings of the 9<sup>th</sup> U.S./Japan Experts Meeting on Toxic Bottom Sediments*, U.S. Army Engineer Waterways Experiment Station, Vicksburg, MS, pp 90-105.

Koba and Shiba 1983

Koba, H., and Shiba, T. 1983. "Sediment Resuspension in the Vicinity of the Cutterhead," *Proceedings of the 8th U.S. Japan Experts Meeting on Toxic Bottom Sediments*, U.S. Army Engineer Waterways Experiment Station, Vicksburg, MS, pp 434-441.

Koh and Chang 1973

Koh, R. C. Y., and Chang, Y. C. 1973. "Mathematical Model for Barged Ocean Disposal of Waste," *Environmental Protection Technology Series EPA 660/2-73-029*, U.S. Army Engineer Waterways Experiment Station, Vicksburg, MS.

Knutson and Inskeep 1983

Knutson, P. L. and Inskeep, M. R. 1983. "Shore Erosion Control with Salt Marsh Vegetation," CETA 83-4, U.S. Army Engineer Coastal Engineering Research Center, Fort Belvoir, VA, 1983.

Kraus 1991

Kraus, N. C., ed. 1991. "Mobile, Alabama, Field Data Collection Project, 18 August-2 September 1989; Report 1, Dredged Material Plume Survey Data Report," Technical Report DRP-91-3, U.S. Army Engineer Waterways Experiment Station, Vicksburg, MS.

Kraus and Thevenot 1992

Kraus, N. C., and Thevenot, M. M. 1992. "The PLUme Measurement System (PLUMES): First Announcement," Technical Note DRP-1-06, U.S. Army Engineer Waterways Experiment Station, Vicksburg, MS. <http://el.erd.c.usace.army.mil/elpubs/pdf/drp1-06.pdf>

Krinitzky, Hynes, and Franklin 1997

Krinitzky E. L., Hynes M. E., and Franklin A.G., 1997 "Earthquake safety evaluation of sanitary landfills," *Engineering Geology*, Volume 46, Number 2, 23 May 1997, pp. 143-156(14).

Krizek, Fitzpatrick, and Atmatzidis 1976

Krizek, R. J., Fitzpatrick, J. A., and Atmatzidis, D. K. 1976. "Investigation of Effluent Filtering Systems for Dredged Material Confinement Facilities," Contract Report D-76-8, U.S. Army Engineer Waterways Experiment Station, Vicksburg, MS.

Krumbein and Sloss 1963

Krumbein, W. C., and Sloss, L. L. 1963. *Stratigraphy and Sedimentation*, 2nd ed., W. H. Freeman and Company, San Francisco, CA.

Kucharski and Clausner 1990

Kucharski, W. M., and Clausner, J. E. 1990. "Underwater Inspection of Coastal Structures Using Commercially Available Sonars," Technical Report REMR-CO-11, U.S. Army Engineer Waterways Experiment Station, Vicksburg, MS.

Kuo, Welch, and Lukens 1985

Kuo, A. Y., Welch, C. S., and Lukens, R. J. 1985. "Dredge Induced Turbidity Plume Model," *Journal of Waterway, Ports, Coastal, and Ocean Engineering*, Vol I 1, pp 476-494.

Lackey 2007

Lackey, T, and MacDonald, N. 2007. "Particle Tracking Model: Description and Processes." U.S. Army Engineer Research and Development Center, Vicksburg, MS. [http://el.erd.c.usace.army.mil/dots/doer/pdf/LackeyandMcDonald\\_2007.pdf](http://el.erd.c.usace.army.mil/dots/doer/pdf/LackeyandMcDonald_2007.pdf)

Lackey and MacDonald 2007

Lackey, T.C., and MacDonald, N.J. 2007. "The Particle Tracking Model Description and Processes," *Proceedings, XVIII World Dredging Congress 2007*, Western Dredging Association, Lake Buena Vista, FL.

EM 1110-2-5025

31 Jul 15

Lambe 1962

Lambe, T. W. 1962. *Soil Testing for Engineers*, John Wiley, New York.

Land and Bray 1998

Land, J. M., and Bray, R. N. 1998. "Acoustic Measurement of Suspended Solids for Monitoring of Dredging and Dredged Material Disposal," *Proceedings, 15th World Dredging Congress*, World Dredging Association, Las Vegas, NV.

Landin 1978

Landin, M. C. 1978. "Annotated Tables of Vegetation Growing on Dredged Material Throughout the United States," Miscellaneous Paper D-78-7, U.S. Army Engineer Waterways Experiment Station, Vicksburg, MS. <http://el.erdc.usace.army.mil/elpubs/pdf/mpd78-7.pdf>

Landin 1980

Landin, M. C. 1980. "Building and Management of Dredged Material Islands for North American Wildlife," *Proceedings 9th World Dredging Conference*, Vancouver, BC, Canada, Western Dredging Association, Arlington, VA, pp 527-539.

Landin 1982

Landin, M. C. 1982. "Habitat Development at Eight Corps of Engineer Sites; Feasibility and Assessment," Miscellaneous Paper D-82-1, U.S. Army Engineer Waterways Experiment Station, Vicksburg, MS.

Landin 1984

Landin, M. C. 1984. "Habitat Development Using Dredged Material," *Proc. Dredging and Dredged Material Disposal Conference*, Tampa, FL, American Society of Civil Engineers, New York, pp 907-918.

Landin 1986a

Landin, M. C. 1986a. "Building, Developing, and Managing Dredged Material Islands for Bird Habitat," Environmental Effects of Dredging Program Technical Note EEDP-07-01, U.S. Army Engineer Waterways Experiment Station, Vicksburg, MS. <http://el.erdc.usace.army.mil/elpubs/pdf/eedp07-1.pdf>

Landin 1986b

Landin, M. C. 1986b. "The Success Story of Gaillard Island: A Corps Confined Disposal Facility," *Proceedings of the 19th Dredging Seminar*, October 1986, Baltimore, MD. Texas A&M University, College Station, TX, pp 41-54.

Landin 1990

Landin, M. C. 1990. "Reclamation of an Abandoned Salt Pond as Salt Marsh in South San Francisco Bay, CA," *Beneficial Uses of Dredged Material in the Western United States*, May 1990, San Diego, CA. M. C. Landin, ed., U.S. Army Engineer Waterways Experiment Station, Vicksburg, MS.

## Landin 1992a

Landin, M. C. 1992a. "Beneficial Uses of Dredged Material Projects: How, When, Where, and What to Monitor and Why it Matters," *Proceedings, Ports '92, Permanent International Association of Navigation Congresses*, July 1992, Seattle, WA. American Society of Civil Engineers, New York, pp 142-148.

## Landin 1992b

Landin, M. C. 1992b. "Need, Construction, and Management of Dredged Material Islands for Wildlife," *Handbook of Dredging Engineering*, J. B. Herbich, ed., McGraw-Hill, New York, pp 9.81-9.100.

## Landin 1993

Landin, M. C. 1993. "Pointe Mouillee: A 4600 Acre Multiple Purpose Habitat Constructed and Restored in Western Lake Erie, USA," *Proceedings of the 8<sup>th</sup> Symposium on Coastal and Ocean Management*, July 1993, New Orleans, LA. O. R. Magoon, et al., eds., American Society of Civil Engineers, New York, pp 2705-2715.

## Landin 1995

Landin, M. C. 1995. "The Role of Technology and Engineering in Wetland Restoration and Creation," *Proceedings of the National Wetlands Engineering Workshop*, St. Louis, MO, August 1993. Technical Report WRP-RE-08, 1995, U.S. Army Engineer Waterways Experiment Station, Vicksburg, MS, pp 3-16.

## Landin 1997a

Landin, M. C. 1997a. "Concept, History, and Examples of Beneficial Uses of Dredged Material," *Proceedings of the International Workshop on Dredged Material Beneficial Uses*, July 28-August 1, 1997, Baltimore, MD. M. C. Landin, ed., U.S. Army Engineer Waterways Experiment Station, Vicksburg, MS, pp 3-12.

## Landin 1997b

Landin, M. C. 1997b. "Current Agricultural Applications of Dredged Material in Washington, New Jersey, South Carolina, and Mississippi," *Proceedings of the International Workshop on Dredged Material Beneficial Uses*, July 28-August 1, 1997, Baltimore, MD. M. C. Landin, ed., U.S. Army Engineer Waterways Experiment Station, Vicksburg, MS, pp 101-102.

## Landin 1997c

Landin, M. C. 1997c. "The History, Practice, and Studies of Construction, Nourishment, Protection, Monitoring, and Management of more than 2000 Dredged Material Islands in U.S. Waterways," *Proceedings of the International Workshop on Dredged Material Beneficial Uses*, July 28-August 1, 1997, Baltimore, MD. M. C. Landin, ed., U.S. Army Engineer Waterways Experiment Station, Vicksburg, MS, pp 82-85.

Landin 1997d

Landin, M. C. 1997d. "Twenty-five Years of Long-Term Monitoring of Wetland Projects Constructed with Dredged Material, with Comparisons to Natural Wetlands, throughout the United States," *Proceedings of the International Workshop on Dredged Material Beneficial Uses*, July 28-August 1, 1997, Baltimore, MD. M. C. Landin, ed., U.S. Army Engineer Waterways Experiment Station, Vicksburg, MS, pp 26-30.

Landin 1998a

Landin, M. C. 1998a. "Beneficial Uses of Dredged Material: Island and Wetland Habitat Restoration and Creation," *Proceedings, 15<sup>th</sup> World Dredging Congress*, June 28-July 2, Las Vegas, NV. Western Dredging Association, Portland, OR, pp 733-747.

Landin 1998b

Landin, M. C. 1998b. "Long-Term Monitoring of Manmade Wetlands in Comparison to Natural Wetlands: A 26-Year Track Record" (On CD-ROM), *Proceedings of the Wetlands, Engineering, and River Restoration Conference*, March 1988, Denver, CO. American Society of Civil Engineers.

Landin and Miller 1988

Landin, M. C., and Miller, A. C. 1988. Beneficial Uses of Dredged Material: A Strategic Dimension of Water Resource Management," *Transactions of the 53<sup>rd</sup> North American Wildlife and Natural Resources Conference*, March 1988, Phoenix, AZ. Wildlife Management Institute, Washington, DC, pp 316-325.

Landin et al. 1999

Landin, M. C., Brooke, J., Adnitt, C., and Meakins, N. 1999. "Saltmarsh Restoration in the United Kingdom Using Manipulations and Dredged Material," *Proceedings of the 19<sup>th</sup> Technical Conference of the Western Dredging Association*, May 1999, Louisville, KY. R. E. Randall, ed., American Society of Civil Engineers, New York, pp 369-377.

Landin, Dardeau, and Miller 1992

Landin, M. C., Dardeau, E. A., and Miller, J. L. 1992. "Wetland Restoration and Creation Guidelines for Mitigation," *Water Forum '92*, Baltimore, MD, pp 439-444.

Landin, Fowler, and Allen 1994

Landin, M. C., Fowler, J., and Allen, H. H. 1994. "New Applications and Practices for Beneficial Uses of Dredged Material," *Proceedings of the Second International Conference on Dredging and Dredged Material Placement*, November 1994, Lake Buena Vista, FL. E. C. McNair, Jr., ed., American Society of Civil Engineers, New York, pp 526-536.

Landin, Hayes, and Payne 1997

Landin, M. C., Hayes, D. F., and Payne, B. S. 1997. "Wetland Monitoring and Success Evaluation with Emphasis on the Northern Gulf of Mexico," Technical Report furnished to the Gulf of Mexico Program, U.S. Environmental Protection Agency, U.S. Army Engineer Waterways Experiment Station, Vicksburg, MS.

Landin, Webb, and Knutson 1989

Landin, M. C., Webb, J. W., and Knutson, P. L. 1989. "Long-Term Monitoring of Eleven Corps of Engineers Habitat Development Field Sites Built of Dredged Material," Technical Report D-89-01, U.S. Army Engineer Waterways Experiment Station, Vicksburg, MS. <http://el.erdc.usace.army.mil/elpubs/pdf/trd89-1/cover.pdf>

Langan 1987

Langan, P. 1987. "Benefits of Underwater Berms," *Proceedings of the First Interagency Workshop on Beneficial Uses of Dredged Material*, October 1986, Pensacola, FL. Technical Report D-87-1, U.S. Army Engineer Waterways Experiment Station, Vicksburg, MS. pp 226-231.

Larson and Moehl 1990

Larson, K. W., and Moehl, C. E. 1990. "Entrainment of Anadromous Fish by Hopper Dredging at the Mouth of the Columbia River, Oregon and Washington," *Proceedings, Workshop on the Effects of Dredging on Anadromous Fishes on the Pacific Coast*, Washington Sea Grant Program, Seattle, WA, pp 100-110.

LaSalle 1990

LaSalle, M. W. 1990. "Physical and Chemical Alterations Associated with Dredging: An Overview," *Proceedings of a Workshop on the Effects of Dredging on Anadromous Pacific Coast Fishes*, 8-9 September 1988, Seattle, WA. C. A. Simenstad, ed., Washington Sea Grant Program, University of Washington, pp 1-12.

LaSalle and Sims 1989

LaSalle, M. W., and Sims, L. G. 1989. "Effects of Unconfined Disposal of Dredged Material on Macrobenthic Assemblages in Winyah Bay, South Carolina," prepared for U.S. Army Engineer District, Charleston, Charleston, SC.

LaSalle et al. 1991

LaSalle, M. W., Clarke, D. G., Homziak, J., Lunz, J. D., and Fredette, T. J. 1991. "A Framework for Assessing the Need for Seasonal Restrictions on Dredging and Disposal Operations," Technical Report D-91-1, U.S. Army Engineer Waterways Experiment Station, Vicksburg, MS. <http://el.erdc.usace.army.mil/dots/pdfs/trd91-1.pdf>

Leathem et al. 1973

Leathem, W., Kinner, P., Maurer, D., Biggs, R., and Treasure, W. 1973. "Effects of Spoil Disposal on Benthic Invertebrates," *Marine Pollution Bulletin*, Vol 4, pp 122-125.

Lee 2001a

Lee, L. T. 2001a. "In Situ Expedient Test Methods to Determine Geotechnical Properties of Dredged Material," *DOER Technical Notes Collection ERDC TN-DOER-N12*, U.S. Army Engineer Research and Development Center, Vicksburg, MS. <http://el.erdc.usace.army.mil/elpubs/pdf/doern12.pdf>



EM 1110-2-5025

31 Jul 15

Lee 2001b

Lee, L. T. 2001b. "Geotechnical Properties and Sediment Characterization for Dredged Material Models," *DOER Technical Notes Collection* ERDC TN-DOER-N13, U.S. Army Engineer Research and Development Center, Vicksburg, MS. <http://el.ercd.usace.army.mil/elpubs/pdf/doern13.pdf>

Lee and Skogerboe 1983

Lee, C. R., and Skogerboe, J. G. 1983. "Prediction of Surface Runoff Water Quality from an Upland Dredged Material Disposal Site," *Proceedings, International Conference on Heavy Metals in the Environment*, Heidelberg, Germany.

Lee, Engler, and Mahloch 1976

Lee, C. R., Engler, R. N., and Mahloch, J. L. 1976. "Land Application of Waste Materials from Dredging, Construction, and Demolition Processes," Miscellaneous Paper D-76-5, U.S. Army Engineer Waterways Experiment Station, Vicksburg, MS. <http://el.ercd.usace.army.mil/elpubs/pdf/mpd76-5.pdf>

Lee, Sturgis, and Landin 1976

Lee, C. R., Sturgis, T. C., and Landin, M. C. 1976. "A Hydroponic Study of Heavy Metal Uptake by Selected Marsh Plant Species," Technical Report D-76-05, U.S. Army Engineer Waterways Experiment Station, Vicksburg, MS.

Lee et al. 1975

Lee, G. F., Piwoni, M. D., Lopez, J. M., Mariani, G. M., Richardson, J. S., Homer, D. H., and Soleh, F. 1975. "Research Study for the Development of Dredged Material Disposal Criteria," Contract Report D-75-4, U.S. Army Engineer Waterways Experiment Station, Vicksburg, MS. <http://el.ercd.usace.army.mil/elpubs/pdf/crd75-4/cover.pdf>

Lee et al. 1978

Lee, C. R., Smart, R. M., Sturgis, T. C., Gordon, R. N., and Landin, M. C. 1978. "Prediction of Heavy Metal Uptake by Marsh Plants Based on Chemical Extraction of Heavy Metals from Dredged Material," Technical Report D-78-06, U.S. Army Engineer Waterways Experiment Station, Vicksburg, MS. <http://el.ercd.usace.army.mil/elpubs/pdf/trd78-6.pdf>

Lee et al. 1985

Lee, C. R., Skogerboe, J. G., Eskew, K., Price, R. A., Page, N. R., Clar, M., Kort, R., and Hopkins, H. 1985. "Restoration of Problem Soil Materials at Corps of Engineers Construction Sites," Instruction Report EL-85-2, U.S. Army Engineer Waterways Experiment Station, Vicksburg, MS.

Lee et al. 1991

Lee, C. R., Tatem, H. E., Brandon, D. L., Kay, S. H., Peddicord, R. K., Palermo, M. R., and Francingues, N. R., Jr. 1991. "General Decisionmaking Framework for Management of Dredged Material – Example Application to Commencement Bay, Washington," Miscellaneous Paper 91-1, U.S. Army Engineer Waterways Experiment Station, Vicksburg, MS. <http://el.ercd.usace.army.mil/dots/pdfs/mpd91-1/cover.pdf>



## Lewis and Phillips 1981

Lewis, R. R., and Phillips, R. 1981. "Experimental Seagrass Mitigation in the Florida Keys," *Proceedings U.S. Fish and Wildlife Service Workshop on Coastal Ecosystems of the Southeastern United States*. U.S. Fish and Wildlife Service, Washington, DC, pp 143-152.

## Little and Quick 1976

Little, E. J., and Quick, J. A., Jr. 1976. "Ecology, Resource Rehabilitation, and Fungal Parasitology of Commercial Oysters in Pensacola Estuary, FL," Florida Marine Research Publication No. 21, 89 pp

## Lohrmann and Huhta 1994

Lohrmann, A., and Huhta, C. 1994. "Plume Measurement System (PLUMES) Calibration Experiment," Technical Report DRP-94-3, U.S. Army Engineer Waterways Experiment Station, Vicksburg, MS.

## Loosanoff and Tommers 1948

Loosanoff, V. L., and Tommers, F. D. 1948. "Effects of Suspended Silt and Other Substances on Rate of Feeding of Oysters," *Science*, Vol 107, pp 69-70.

## Loucks 1970

Loucks, O. L. 1970. "Evolution of Diversity, Efficiency, and Community Stability," *American Zoologist*, Vol 10, pp 17-25.

## Lunz 1986

Lunz, J. D. 1986. "Application of the Benthic Resources Assessment Technique (BRAT) to the Foul Area Disposal Site," prepared for U.S. Army Engineer Division, New England, Waltham, MA.

## Lunz and LaSalle 1986

Lunz, J. D., and LaSalle, M. W. 1986. "Physicochemical Alterations of the Environment Associated with Hydraulic Cutterhead Dredging," *American Malacological Bulletin*, Special Edition No. 3, pp 31-36.

## Lunz, Diaz, and Cole 1978

Lunz, J. D., Diaz, R. J., and Cole, R. A. 1978. "Upland and Wetland Habitat Development with Dredged Material: Ecological Considerations," Technical Report DS-78-15, U.S. Army Engineer Waterways Experiment Station, Vicksburg, MS. <http://el.erdc.usace.army.mil/elpubs/pdf/trd78-15A.pdf>

## Lunz, LaSalle, and Houston 1988

Lunz, J. D., LaSalle, M. W., and Houston, L. J. 1988. "Predicting Dredging Impacts on Dissolved Oxygen," *Proceedings of the First Annual Meeting on Puget Sound Research*, Puget Sound Water Quality Authority, Seattle, WA, pp 331-336.

EM 1110-2-5025

31 Jul 15

Lunz, Nelson, and Tatem 1984

Lunz, J. D., Nelson, D. A., and Tatem, H. E. 1984. "Aquaculture in Dredged Material Containment Areas," *Proceedings Dredging and Dredged Material Disposal Conference*. American Society of Civil Engineers, Tampa, FL, pp 811-819.

MacDonald et al. 2006

MacDonald, N. J., Davies, M. H., Zundel, A. K., Howlett, J. D., Demirbilek, Z., Gailani, J. Z., Lackey, T. C., and Smith, J. 2006. "PTM: Particle Tracking Model; Report 1: Model Theory, Implementation, and Example Applications," Technical Report ERDC/CHL-TR-06-20, U.S. Army Engineer Research and Development Center, Vicksburg, MS. <http://acwc.sdp.sirsi.net/client/search/asset/1000777>

Mackin 1961

Mackin, J. G. 1961. "Canal Dredging and Silting in Louisiana Bays," *Publications of the Institute of Marine Science*, University of Texas, Vol 7, pp 262-314.

Mang et al. 1978

Mang, J. L., Lu, S., Lofy, R. J., and Stearns, R. P. 1978. "A Study of Leachate from Dredged Material in Upland Areas and/or in Productive Uses," Technical Report D-78-20, U.S. Army Engineer Waterways Experiment Station, Vicksburg, MS. <http://el.erd.c.usace.army.mil/elpubs/pdf/trd78-20/cover.pdf>

Mann et al. 1975

Mann, R., Niering, W. A., Sabbatina, R., and Wells, P. 1975. "Landscape Concept Development for Confined Dredged Material Sites," Contract Report D-75-5, U.S. Army Engineer Waterways Experiment Station, Vicksburg, MS.

Maragos et al. 1977

Maragos, J. E., Roach, J., Bowers, R. L., Hemmes, D. E., Self, R. F. L., Macneil, J. D., Ellis, K., Omeara, P., Vansant, J., Sato, A., Jones, J. P., and Kam, D. T. O. 1977. "Environmental Surveys Before, During and After Offshore Marine Sand Mining Operations at Keouhou Bay, Hawaii," Sea Grant College Program, Working Paper No. 28, University of Hawaii, Honolulu, HI.

Marion and Shamis 1977

Marion, W. R., and Shamis, J. D. 1977. "An Annotated Bibliography of Bird Sampling Techniques," *Bird Banding*, Vol. 48, No. 1, pp 42-61.

Markey and Putman 1976

Markey, J. W., and Putnam, H. D. 1976. "A Study of the Effects of Maintenance Dredging on Selected Ecological Parameters in the Gulfport Ship Channel, Gulfport, Mississippi," *Proceedings of the Specialty Conference on Dredging and Its Environmental Effects*, American Society of Civil Engineers, pp 821-832.

## Marsh 1994

Marsh, J. 1994. "Monitoring of a Dredging Operation Using Innovative Sediment Tracing Techniques," *Dredging '94; Proceedings of the Second International Conference on Dredging and Dredged Material Placement*, Lake Buena Vista, FL, 13-16 November 1994. E. C. McNair, Jr., ed., American Society of Civil Engineers, New York, pp 1360-1369.

## Mathis and Payne 1984

Mathis, D. B., and Payne, B. S. 1984. "Guidance for Designation of Ocean Sites for Dredged Material Dumping," *Environmental Effects of Dredging Information Exchange Bulletin*, Vol D-84-2, U.S. Army Engineer Waterways Experiment Station, Vicksburg, MS.

## Matthews et al. 1999

Matthews, G. P., Knoesel, E. C., Nocera, J. J., and Wakeman, T. H., III. 1999. "Operating the Newark Bay Confined Disposal Facility," *Proceedings of the Western Dredging Association Nineteenth Technical Conference and Thirty-First Annual Texas A&M Dredging Seminar*, May 15-18, 1999, Louisville, KY, pp 475-482.

## Maurer 1967

Maurer, D. L. 1967. "Burial Experiments on Marine Pelecypods from Tomales Bay, California," *Veliger*, Vol 9, pp 376-381.

## Maurer et al. 1974

Maurer, D. L., Biggs, R., Leathern, W., Kimer, P., Treasure, W., Otley, M., Watling, L., and Klemas, V. 1974. "Effect of Spoil Disposal on Benthic Communities Near the Mouth of Delaware Bay," College of Marine Studies, University of Delaware, Lewes and Newark, DE.

## Maurer et al. 1986

Maurer, D. L., Keck, R. T., Tinsman, J. C., Leathern, W. A., Wethe, C., Lord, C., and Church, T. M. 1986. "Vertical Migration and Mortality of Marine Benthos in Dredged Material: A Synthesis," *International Revue der Gesamten Hydrobiologie*, Vol 71, pp 49-63.

## May 1973

May, E. B. 1973. "Environmental Effects of Hydraulic Dredging in Estuaries," Bulletin No. 9, Alabama Marine Resources, Dauphin Island, AL.

## May 1974

May, E. B. 1974. "Effects on Water Quality When Dredging a Polluted Harbor Using Confined Spoil Disposal," *Alabama Marine Resources Bulletin*, Vol 10, pp 1-8.

## McCauley, Parr, and Hancock 1977

McCauley, J. E., Parr, R. A., and Hancock, D. R. 1977. "Benthic Infauna and Maintenance Dredging: A Case Study," *Water Research*, Vol I 1, pp 233-242.

McDonnell and Tillman 1992

McDonnell, T. M., and Tillman, R. K. 1992. "Dredge Data-Logging System; A Prelude to the Silent Inspector," Dredging Research Program Information Exchange Bulletin DRP-92-2, U.S. Army Engineer Waterways Experiment Station, Vicksburg, MS.

McGee, Ballard, and Caulfield 1995

McGee, R. G., Ballard, R. F., and Caulfield, D. D. 1995. "A Technique to Assess the Characteristics of Bottom and Subbottom Marine Sediments," Technical Report DRP-953, U.S. Army Engineer Waterways Experiment Station, Vicksburg, MS.

McLellan et al. 1989

McLellan, T. N., Havis, R. N., Hayes, D. F., and Raymond, G. L. 1989. "Field Studies of Sediment Resuspension Characteristics of Selected Dredges," Technical Report HL-89-9, U.S. Army Engineer Waterways Experiment Station, Vicksburg, MS. <http://www.dtic.mil/dtic/tr/fulltext/u2/a207922.pdf>

McNair and Banks 1986

McNair, E. C., Jr., and Banks, G. E. 1986. "Prediction of Flow Fields Near the Suction of a Cutterhead Dredge," *American Malacological Bulletin*, Special Edition No. 3, pp 37-40.

Merkle 1990

Merkle, K. 1990. "The Use of Dredged Material in the Development of Eelgrass Meadows," *Beneficial Uses of Dredged Material in the Western United States: Proceedings of a Technical Workshop*, May 1990, San Diego, CA. M. C. Landin, ed., U.S. Army Engineer Waterways Experiment Station, Vicksburg, MS.

Mesa 1995

Mesa, C. 1995. "Containerization of Contaminated Dredge Sediments – the Marina Del Rey Experience," *Proceedings of the 25th Texas A&M Annual Dredging Seminar*, TAMU Center for Dredging Studies, College Station, TX.

Montgomery 1978

Montgomery, R. L. 1978. "Methodology for Design of Fine-Grained Dredged Material Containment Areas," Technical Report D-78-56, U.S. Army Engineer Waterways Experiment Station, Vicksburg, MS. <http://www.dtic.mil/dtic/tr/fulltext/u2/a207922.pdf>

Montgomery et al. 1978

Montgomery, R. L., Ford, A. W., Poindexter, M. E., and Bartos, M. J. 1978. "Guidelines for Dredged Material Disposal Area Reuse Management," Technical Report DS-78-12, U.S. Army Engineer Waterways Experiment Station, Vicksburg, MS. <http://el.erdc.usace.army.mil/dots/pdfs/ds78-12/trds78-12a.pdf>

Moore, Spadaro, and Degens 2000

Moore, R. F., Spadaro, P. A., and Degens, S. 2000. "Ross Island Lagoon - A Case Study for Confined Disposal of Contaminated Dredged Material, Portland, Oregon." *Proceedings of the Third Specialty Conference on Dredging and Dredged Material Disposal - Dredging '02 - Key Technologies for Global Prosperity*, 5-8 May 2002, Orlando, FL. Stephen Garbaciak, Jr., ed., American Society of Civil Engineers.

Morang, Larson, and Gorman 1997a

Morang, A., Larson, R., and Gorman, L. 1997a. "Monitoring the Coastal Environment; Part I: Waves and Currents," *Journal of Coastal Research*, 13(1), 111-133. Fort Lauderdale, FL.

Morang, Larson, and Gorman 1997b

Morang, A., Larson, R., and Gorman, L. 1997b. "Monitoring the Coastal Environment; Part III: Geophysical and Research Methods," *Journal of Coastal Research*, 13(4), 1064-1085. Fort Lauderdale, FL.

Morgan, Rasin, and Noe 1983

Morgan, R. P., Rasin, V. J., and Noe, L. A. 1983. "Sediment Effects on Eggs and Larvae of Striped Bass and White Perch," *Transactions of the American Fisheries Society*, Vol 112, pp 220-224.

Moritz, Johnson, and Scheffner 2000

Moritz, H. R., Johnson, B. H., and Scheffner, N. W. 2000. "Numerical Models for Predicting the Fate of Dredged Material Placed in Open Water," Chapter 16 in *Handbook of Coastal Engineering*, J. B. Herbich, ed., McGraw-Hill, New York.

Morris and Fredette 2002

Morris, J. T., and Fredette, T. J. 2002. "Development and Long-Term Fate of a Capped Disposal Mound at an Open Water Dredged Material Disposal Site." *Proceedings of the Third Specialty Conference on Dredging and Dredged Material Disposal - Dredging '02 - Key Technologies for Global Prosperity*, 5-8 May 2002, Orlando, FL. Stephen Garbaciak, Jr., ed., American Society of Civil Engineers.

Morrison 1971

Morrison, G. 1971. "Dissolved Oxygen Requirements for Embryonic and Larval Development of the Hard Shell Clam, *Mercenaria mercenaria*," *Journal of the Fisheries Research Board of Canada*, Vol 28, pp 379-381.

Morton 1977

Morton, L. W. 1977. "Ecological Effects of Dredging and Dredge Spoil Disposal: A Literature Review," Technical Paper No. 94, U.S. Fish and Wildlife Service, Washington, DC.

Mudroch and Azcue 1995

Mudroch, A., and Azcue, M. A. 1995. "Aquatic Sediment Sampling," Lewis Publishers, Boca Raton, FL.

EM 1110-2-5025

31 Jul 15

Murray et al. 1998

Murray, P. M., Fredette, T. J., Jackson, P. E., Wolf, S. H., and Ryther, Jr., J. H. 1998. "Monitoring Results from the First Boston Harbor Navigation Improvement Project Confined Aquatic Disposal Cell." *Proceedings of the Fifteenth World Dredging Congress, Dredging into the 21st Century and Exhibition*, 28 June to 2 July 1998, Las Vegas, NV. R. E. Randall, ed., pp 415-430.

Myers 1990

Myers, T. E. 1990. "Preliminary Guidelines and Conceptual Framework for Comprehensive Analysis of Migration Pathways (CAMP) of Contaminated Dredged Material," *Environmental Effects of Dredging Technical Notes*, EEDP-06-11, U.S. Army Engineer Waterways Experiment Station, Vicksburg, MS. <http://el.erdc.usace.army.mil/dots/pdfs/eedp06-11.pdf>

Myers 1996

Myers, T. E. 1996. "Leachate Testing and Evaluation for Estuarine Sediments," Technical Report D-96-1, U.S. Army Engineer Waterways Experiment Station, Vicksburg, MS.

Myers and Bannon 1991

Myers, T. E., and Brannon, J. M. 1991. "Technical Considerations for Application of Leach Tests to Sediments and Dredged Material," *Environmental Effects of Dredging Technical Notes* EEDP-02-15, U.S. Army Engineer Waterways Experiment Station, Vicksburg, MS. <http://el.erdc.usace.army.mil/dots/pdfs/eedp02-15.pdf>

Myers, Gambrell, and Tittlebaum 1991

Myers, J. E., Gambrell, R. P., and Tittlebaum, M. E. 1991. "Design of an Improved Column Leaching Apparatus for Sediments and Dredged Material," Miscellaneous Paper D-91-3, U.S. Army Engineer Waterways Experiment Station, Vicksburg, MS.

Myre, Walter, and Rollings 2000

Myre, P. L., Walter, P. J., and Rollings, M. P. 2000. "Geotechnical Evaluation of Sediment Data Collected in Boston Harbor Confined Aquatic Disposal Cell." *Proceedings of the Western Dredging Association, Twentieth Technical Conference and Thirty-Second Texas A&M Dredging Seminar*, June 25- 28, 2000, Warwick, RI. pp 303-315.

Nakai 1978

Nakai, O. 1978. "Turbidity Generated by Dredging Projects," *Management of Bottom Sediments Containing Toxic Substances*, Proceedings of the 3rd U.S. Japan Experts Meeting, U.S. Army Engineer Waterways Experiment Station, Vicksburg, MS, pp 25-34.

Naqvi and Pullen 1982

Naqvi, S. M., and Pullen, E. J. 1982. "Effects of Beach Nourishment and Borrowing on Marine Organisms," Miscellaneous Report No. 82-14, U.S. Army Engineer Coastal Engineering Research Center, Fort Belvoir, VA.

## Nathans and Bechtel 1977

Nathans, M. W., and Bechtel, T. J. 1977. "Availability of Sediment-Adsorbed Selected Pesticides to Benthos with Particular Emphasis on Deposit-Feeding Infauna," Technical Report D-77-34, U.S. Army Engineer Waterways Experiment Station, Vicksburg, MS. <http://el.erdc.usace.army.mil/elpubs/pdf/trd77-34.pdf>

## National Dredging Team 1998

National Dredging Team. 1998. "Local Planning Groups and Development of Dredged Material Management Plans," Washington, DC. <http://www.epa.gov/owow/oceans/ndt/>.

## National Oceanic and Atmospheric Administration 1980

National Oceanic and Atmospheric Administration. 1980. "Narrative Summaries, Tables, and Maps for Each State," *Climates of the States*, 2nd ed., Vol 1 and 2, Gale Research Company, Detroit, MI.

## National Research Council 1994

National Research Council. 1994. "Restoring and Protecting Marine Habitat: The Role of Engineering and Technology," National Academy Press, Washington, DC.

## National Research Council 1997

National Research Council. 1997. "Contaminated Sediments in Ports and Waterways: Cleanup Strategies and Technologies," National Academy Press, Washington, DC.

## National Research Council's Transportation Research Board-Marine Board 2001

National Research Council's Transportation Research Board-Marine Board. 2001. "A Process for Setting, Managing, and Monitoring Environmental Windows for Dredging Projects," Special Report 262, National Academy Press, Washington, DC.

## Natural Resources Conservation Service 1992

Natural Resources Conservation Service. 1992. "Engineering Field Handbook: Wetland Restoration, Enhancement, or Creation," EM 210-EFH, 1/92, U.S. Department of Agriculture, Washington, DC.

## Natural Resources Conservation Service 1998

Natural Resources Conservation Service. 1998. "Stream Corridor Restoration: Principles, Processes, and Practices," PB98-158348LUW, U.S. Department of Agriculture, Federal Interagency Stream Restoration Working Group, Washington, DC.

## Neal, Henry, and Greene 1978

Neal, R. W., Henry, G., and Greene, S. H. 1978. "Evaluation of the Submerged Discharge of Dredged Material Slurry During Pipeline Dredge Operations," Technical Report D-78-44, U.S. Army Engineer Waterways Experiment Station, Vicksburg, MS. <http://el.erdc.usace.army.mil/elpubs/pdf/trd78-44.pdf>

EM 1110-2-5025

31 Jul 15

Neff 1968

Neff, D. J. 1968. "The Pellet-Group Count Technique for Big Game Trend, Census, and Distribution: A Review," *Journal of Wildlife Management*, Vol. 32, No. 3, pp 597-614.

Neff, Foster, and Slowey 1978

Neff, L. W., Foster, R. S., and Slowey, J. F. 1978. "Availability of Sediment-Adsorbed Heavy Metals to Benthos with Particular Emphasis on Deposit-Feeding Infauna," Technical Report D-78-42, U.S. Army Engineer Waterways Experiment Station, Vicksburg, MS. <http://el.erdc.usace.army.mil/elpubs/pdf/trd78-42/cover.pdf>

Nelson 1985

Nelson, W. G. 1985. "Guidelines for Beach Restoration Projects. Part 1 Biological," Florida Sea Grant Report 76, 66 pp.

Nelson 1993

Nelson, W. G. 1993. "Beach Restoration in the Southeastern U.S.: Environmental Effects and Biological Monitoring," *Ocean and Coastal Management* 19:157-182.

Nelson and Pullen 1985

Nelson, D. A., and Pullen, E. L. 1985. "Environmental Considerations in Using Beach Nourishment for Erosion Protection," Proceedings of the Second Water Quality and Wetlands Management Conference, Louisiana Environmental Professionals Association, pp 357-377.

Nester and Rees 1988

Nester, R. D., and Rees, S. I. 1988. "Thin-Layer Dredged Material Disposal - Fowl River, Alabama, Test Case," Information Exchange Bulletin D-88-4, U.S. Army Engineer Waterways Experiment Station, Vicksburg, MS.

Newell, Seiderer, and Hitchcock 1998

Newell, R. C., Seiderer, L. J., and Hitchcock D. R. 1998. "The Impact of Dredging Works in Coastal Waters: A Review of the Sensitivity to Disturbance and Subsequent Recovery of Biological Resources on the Sea Bed," *Oceanography and Marine Biology: An Annual Review* 1998, Vol 36, pp 127-78, UCL Press.

Newling and Landin 1985

Newling, C. J., and Landin, M. C. 1985. "Long-Term Monitoring of Habitat Development at Upland and Wetland Dredged Material Disposal Sites: 1974-1982," Technical Report D-85-5, U.S. Army Engineer Waterways Experiment Station, Vicksburg, MS.

Nilson, Hadden, and Giard 1998

Nilson, S., Hadden, D., and Giard, Jr., P. 1998. "The Boston Harbor Navigation Improvement Project: Dredging Today for a Deeper Tomorrow." *Proceedings of the Fifteenth World Dredging Congress, Dredging into the 21st Century and Exhibition*, 28 June to 2 July 1998, Las Vegas, NV. R. E. Randall, ed., pp 783-797.



Nimmo et al. 1982

Nimmo, D. R., Hamaker, T. L., Matthews, E., and Young, W. T. 1982. "The Long-Term Effects of Suspended Particulates on Survival and Reproduction of the Mysid Shrimp, *Mysidopsis bahia*, in the Laboratory," *Ecological Stress in the New York Bight: Science and Management*, Estuarine Research Federation, Columbia, SC, pp 414-422.

Noakes, Noakes, and Dvoracek 2000

Noakes, J. E., Noakes, S. E., and Dvoracek, D. K. 2000. "Seafloor Survey Systems for Rapid Coastal Assessment: Point and Nonpoint Contamination Sources," *Proceedings, International Conference on Coastal and Ocean Space Utilization; North American and European Perspectives on Ocean and Coastal Policy 1*, 1-7. Biliiana Cicin-Sain and Evelia Rivera-Arriaga, eds.

O'Connor, Neumann, and Sherk 1976

O'Connor, J. M., Neumann, D. A., and Sherk, J. A. 1976. "Lethal Effects of Suspended Sediment on Estuarine Fish," Technical Paper No. 76-20, U.S. Army Engineer Waterways Experiment Station, Vicksburg, MS.

Office, Chief of Engineers, Department of the Army 1960

Office, Chief of Engineers, Department of the Army. 1960. "The Unified Soil Classification System," Standard 619, Washington, DC.

Ofuji and Naoshi 1976

Ofuji, I., and Naoshi, I. 1976. "Antiturbidity Overflow System for Hopper Dredge," *Dredging, Environmental Effects and Technology: Proceedings of Seventh World Dredging Conference, WODCON VII*, San Francisco, CA, pp 207-234.

Ohman and Ream 1971

Ohman, L. F., and Ream, R. R. 1971. "Wilderness Ecology: A Method of Sampling and Summarizing Data for Plant Community Classification," USDA Forest Research Paper NC-49, North Central Forest Experiment Station, St. Paul, MN, 14 pp.

Olin, Miller, and Palermo 1993a

Olin, T. J., Miller, A. C., and Palermo, M. R. 1993a. "Environmental Effects Evaluation for Thalweg Disposal of Dredged Material," Technical Note EEDP-01-30, U.S. Army Engineer Waterways Experiment Station, Vicksburg, MS. <http://el.erdc.usace.army.mil/dots/pdfs/eedp01-30.pdf>

Olin, Miller, and Palermo 1993b

Olin, T. J., Miller, A. C., and Palermo, M. R. 1993b. "Implementation Approach for Thalweg Disposal of Dredged Material," Technical Note EEDP-01-31, U.S. Army Engineer Waterways Experiment Station, Vicksburg, MS. <http://el.erdc.usace.army.mil/dots/pdfs/eedp01-31.pdf>

EM 1110-2-5025

31 Jul 15

Oliver et al. 1977

Oliver, J. S., Slattery, P. N., Hulberg, L. W., and Nybakken, J. W. 1977. "Patterns of Succession in Benthic Infaunal Communities Following Dredging and Dredged Material Disposal in Monterey Bay," Technical Report D-77-27, U.S. Army Engineer Waterways Experiment Station, Vicksburg, MS. [http://aquaticcommons.org/2612/1/Tech\\_Report\\_D-77-27.pdf](http://aquaticcommons.org/2612/1/Tech_Report_D-77-27.pdf)

Olsen 1984

Olsen, L. A. 1984. "Effects of Contaminated Sediment on Fish and Wildlife: Review and Annotated Bibliography," FWS/OBS-82/66, U.S. Fish and Wildlife Service, Washington, DC.

Onuschuk 1982

Onuschuk, E. 1982. "Distribution of Suspended Sediment in the Patuxent River, Maryland, During Dredging Operations of Construction of a Pipeline," *Bulletin of the Association of Engineers and Geologists*, Vol 19, pp 25-34.

Orians 1974

Orians, G. H. 1974. "Diversity, Stability, and Maturity in Natural Ecosystems," *Proceedings of the 1st International Congress Ecology, Center for Agricultural Publications and Documents*, Wageningen, Canada, pp 139-150.

Otis 1994

Otis, M. J. 1997. "New Bedford Harbor, Massachusetts, Dredging/Disposal of PCB Contaminated Sediments," *Dredging '94: Proceedings of the Second International Conference on Dredging and Dredged Material Placement*, Orlando, FL, 14-16 November 1994. E. C. McNair, ed., American Society of Civil Engineers, New York, 579-587.

Palermo 1977

Palermo, M. R. 1977. "An Evaluation of Progressive Trenching as a Technique for Dewatering Fine-Grained Dredged Material," Miscellaneous Paper D-77-4, U.S. Army Engineer Waterways Experiment Station, Vicksburg, MS. <http://el.erdc.usace.army.mil/elpubs/pdf/mpd77-4/cover.pdf>

Palermo 1985

Palermo, M. R. 1985. "Predicting Effluent Quality from Confined Dredged Material Disposal Areas," *Environmental Effects of Dredging, Information Exchange Bulletin*. Vol D-85-1. U.S. Army Engineer Waterways Experiment Station, Vicksburg, MS.

Palermo 1992

Palermo, M. R. 1992. Long Term Storage Capacity of Confined Disposal Facilities. Chapter 8, *Handbook of Dredging Engineering*, John B. Herbich, ed., McGraw-Hill, New York.

Palermo 1997

Palermo, M. R. 1997. "Contained Aquatic Disposal of Contaminated Sediments in Subaqueous Borrow Pits," *Proceedings of the Western Dredging Association Eighteenth Technical Conference and Thirtieth Annual Texas A&M Dredging Seminar*, June 29-July 2, 1997, Charleston, SC, pp 249-262.

## Palermo 1999

Palermo, M. R. 1999. "Sizing of Constructed CAD Pits for Lower New York Bay." *Proceedings of the Western Dredging Association, Nineteenth Technical Conference and Thirty-First Texas A&M Dredging Seminar*, May 15-18, 1999, Louisville, KY. pp 53-66.

## Palermo 2002

Palermo, M. R. 2002. "Dredging Operations and Environmental Research: Focus on Contaminated Sediment," *Proceedings of the Third Specialty Conference on Dredging and Dredged Material Disposal - Dredging '02 - Key Technologies for Global Prosperity*, 5-8 May 2002, Orlando, FL. Stephen Garbaciak, Jr., ed., American Society of Civil Engineers.

## Palermo and Averett 2003

Palermo, M. R., and Averett, D. E. 2003. "Environmental Dredging – State of the Art Review," *Proceedings of the Second International Symposium on Contaminated Sediments, Characterization, Evaluation, Mitigation/Restoration*, Ottawa, Canada.

## Palermo and Randall 1989

Palermo, M. R., and Randall, R. E. 1989. "Evaluation of Hopper Loading and Overflow for Saginaw River, Michigan." Miscellaneous Paper D-89-3, U.S. Army Engineer Waterways Experiment Station, Vicksburg, MS. <http://el.erdc.usace.army.mil/dots/pdfs/mpd89-3.pdf>

## Palermo and Randall 1990

Palermo, M. R., and Randall, R. E. 1990. "Practices and Problems Associated with Economic Loading and Overflow of Dredge Hoppers and Scows," Technical Report DRP-90-1, U.S. Army Engineer Waterways Experiment Station, Vicksburg, MS. <http://el.erdc.usace.army.mil/dots/pdfs/trdrp90-1.pdf>

## Palermo and Schroeder 1991

Palermo, M. R., and Schroeder, P. R. 1991. "Documentation of the EFQUAL Module for ADDAMS: Comparison of Predicted Effluent Water Quality with Standards," *Environmental Effects of Dredging Technical Notes* EEDP-06-13, U.S. Army Engineer Waterways Experiment Station, Vicksburg, MS. <http://el.erdc.usace.army.mil/elmodels/pdf/ee-06-13.pdf>

## Palermo and Thackston 1988

Palermo, M. R., and Thackston, E. L. 1988. "Refinement of Column Settling Test Procedures for Estimating the Quality of Effluent from Confined Dredged Material Disposal Areas," Technical Report D-88-9, U.S. Army Engineer Waterways Experiment Station, Vicksburg, MS. <http://el.erdc.usace.army.mil/dots/pdfs/trd88-9.pdf>

## Palermo, Ebersole, and Peyman-Dove 1998

Palermo, M. R., Ebersole, B., and Peyman-Dove, L. 1998. "Siting of Containment Island and Subaqueous Pit Options for the Port of New York/New Jersey." *Proceedings of the Fifteenth World Dredging Congress, Dredging into the 21st Century and Exhibition*, 28 June to 2 July 1998, Las Vegas, NV. R. E. Randall, ed., pp 63-78.

Palermo, Francingues, and Averett 2003

Palermo, M. R., Francingues, N., and Averett, D. E. 2003. "Equipment Selection Factors for Environmental Dredging," *Proceedings of the Western Dredging Association Twenty-Third Technical Conference and Thirty-Fifth Texas A&M Dredging Seminar*, Chicago, IL.

Palermo, Montgomery, and Poindexter 1978

Palermo, M. R., Montgomery, R. L., and Poindexter, M. 1978. "Guidelines for Designing, Operating, and Managing Dredged Material Containment Areas," Technical Report DS-78-10, U.S. Army Engineer Waterways Experiment Station, Vicksburg, MS. <http://el.erdc.usace.army.mil/elpubs/pdf/ds78-10/ds78-10a.pdf>

Palermo, Shields, and Hayes 1981

Palermo, M. R., Shields, F. D., and Hayes, D. L. 1981. "Development of a Management Plan for Craney Island Disposal Area," Technical Report D-81-11, U.S. Army Engineer Waterways Experiment Station, Vicksburg, MS. <http://el.erdc.usace.army.mil/elpubs/pdf/trel81-11/cover.pdf>

Palermo, Teeter, and Homziak 1990

Palermo, M. R., Teeter, A. M., and Homziak, J. 1990. "Evaluation of Clamshell Dredging and Barge Overflow, Military Ocean Terminal, Sunny Point, North Carolina," Technical Report D-90-6, U.S. Army Engineer Waterways Experiment Station, Vicksburg, MS. <http://el.erdc.usace.army.mil/elpubs/pdf/trd90-6.pdf>

Palermo et al. 1998

Palermo, M. R., Clausner, J. E., Rollings, M. P., Williams, G. L., and Myers, T. E. 1998. "Guidance for Subaqueous Dredged Material Capping," Technical Report DOER-1, U.S. Army Engineer Waterways Experiment Station, Vicksburg, MS. <http://el.erdc.usace.army.mil/elpubs/pdf/trdoer1.pdf>

Palermo et al. 2008

Palermo, M. R., Schroeder, P. R., Estes, T.J., and Francingues, N.R. 2008. "Technical Guidelines for Environmental Dredging of Contaminated Sediments" Technical Report ERDC/EL TR-08-29, U.S. Army Engineer Research and Development Center, Vicksburg, MS. <http://el.erdc.usace.army.mil/elpubs/pdf/trel08-29.pdf>

Pankow 1989

Pankow, V. 1989. "Laboratory Tests of Production Meter Instruments," Technical Note DRP-4-01, U.S. Army Engineer Waterways Experiment Station, Vicksburg, MS. <http://el.erdc.usace.army.mil/elpubs/pdf/drp4-01.pdf>

Parnell, Dumond, and McCrimmon 1985

Parnell, J. F., Dumond, D. M., and McCrimmon, D. A. 1985. "Colonial Waterbird Habitats and Nesting Populations in North Carolina Estuaries: 1983 Survey," Technical Report D-86-03, U.S. Army Engineer Waterways Experiment Station, Vicksburg, MS. <http://el.erdc.usace.army.mil/elpubs/pdf/trd86-3.pdf>

Parr, Diener, and Lacy 1978

Parr, T., Diener, E., and Lacy, S. 1978. "Effects of Beach Replenishment on the Nearshore Sand Fauna at Imperial Beach, California," Miscellaneous Report 78-4, U.S. Army Engineer Coastal Engineering Research Center, Fort Belvoir, VA.

Payonk, Palermo, and Teeter 1988

Payonk, P. M., Palermo, M. R., and Teeter, A. M. 1988. "Clamshell Dredging and Overflow Monitoring, Military Ocean Terminal, Sunny Point, N.C.," Proceedings of the Symposium on Coastal Water Resources, American Water Resources Association, pp 95-108.

Pearson 1975

Pearson, T. H. 1975. "The Benthic Ecology of Loch Linnee and Loch Eli, a Sea-Loch System on the West Coast of Scotland; IV. Changes in the Benthic Fauna Attributable to Organic Enrichment," *Journal of Experimental Marine Biology and Ecology*, Vol 20, pp 1-4 1.

Peck, Hanson, and Thornburn 1974

Peck, R. B., Hanson, W. E., and Thornburn, T. H. 1974. *Foundation Engineering*, 2nd ed., John Wiley, New York.

Peddicord and McFarland 1978

Peddicord, R. K., and McFarland, V. A. 1978. "Effects of Suspended Dredged Material on Aquatic Animals," Technical Report D-78-29, U.S. Army Engineer Waterways Experiment Station, Vicksburg, MS. <http://el.ercd.usace.army.mil/elpubs/pdf/trd78-29.pdf>

Peddicord et al. 1975

Peddicord, R. K., McFarland, V. A., Belfiori, D. P., and Byrd, T. E. 1975. "Effects of Suspended Solids on San Francisco Bay Organisms, Dredge Disposal Study; Appendix C – Physical Impact," U.S. Army Engineer District, San Francisco, San Francisco, CA.

Pembroke et al. 1998

Pembroke, A., Bajek, J., Hansen, J. and Hadden, D. 1998. "Creative Resolution to the Problem of Disposal of Boston Harbor, MA (USA), Maintenance Material Unsuitable for Unconfined Open Water Disposal - Success Through Coordination and Cooperation." *Proceedings of the Fifteenth World Dredging Congress, Dredging into the 21st Century and Exhibition*, 28 June to 2 July 1998, Las Vegas, NV. R. E. Randall, ed., pp 821-833.

Pequegnat 1975

Pequegnat, W. E. 1975. *Meiobenthos Ecosystems as Indicators of the Effects of Dredging, Estuarine Research*, Vol II, Academic Press, New York, pp 573-583.

Pequegnat 1984

Pequegnat, W. E. 1984. "Specifications of a Model Ocean Disposal Site for Dredged Material," *Management of Bottom Sediments Containing Toxic Substances, Proceedings of the 8<sup>th</sup> U.S./ Japan Experts Meeting*, U.S. Army Engineer Water Resources Support Center, Fort Belvoir, VA.

EM 1110-2-5025

31 Jul 15

Pequegnat and Sikora 1978

Pequegnat, W. E., and Sikora, W. B. 1978. "Meiofauna and Macroinfauna from Submarine Banks in the Gulf of Mexico," Chapter \_, Northwestern Gulf of Mexico Topographic Features Study, Texas A&M University, College Station, TX, for Bureau of Land Management. U.S. Department of the Interior, Washington, DC.

Pequegnat, Gallaway, and Wright 1990

Pequegnat, W. E., Gallaway, B. J., and Wright, T. D. 1990. "Revised Procedural Guide for Designation Surveys of Ocean Dredged Material Sites," Technical Report D-90-8, U.S. Army Engineer Waterways Experiment Station, Vicksburg, MS. <http://el.erdc.usace.army.mil/elpubs/pdf/trd90-8/cover.pdf>

Per Bruun 1990

Per Bruun. 1990. *Port Engineering*, Gulf Publishing Company, Houston, TX.

Permanent International Association of Navigation Congresses (PIANC) 1996

Permanent International Association of Navigation Congresses. 1996. "Handling and Treatment of Contaminated Dredged Material from Ports and Inland Waterways - CDM," Report of Working Group No. 17 of the Permanent Technical Committee I, Supplement to Bulletin No. 89, 1996, Permanent International Association of Navigation Congresses, Brussels, Belgium.

Perrier, Llopis, and Spaine 1980

Perrier, E. R., Llopis, J. L., and Spaine, P. A. 1980. "Area Strip Mine Reclamation Using Dredged Material: A Field Demonstration," Technical Report EL-80-4, U.S. Army Engineer Waterways Experiment Station, Vicksburg, MS. <http://el.erdc.usace.army.mil/elpubs/pdf/trel80-4/trel80-4.pdf>

Pfitzenmeyer 1970

Pfitzenmeyer, H. T. 1970. "Benthos," Chesapeake Bay Laboratory, *Gross Physical and Biological Effects of Overboard Spoil Disposal in Upper Chesapeake Bay*, Natural Resources Institute Special Report 3, University of Maryland, Solomons, MD, pp 26-38.

Phillips 1980

Phillips, R. 1980. "Planting Guideline for Seagrasses," EA 80-2, U.S. Army Engineer Coastal Engineering Resources Center, Fort Belvoir, VA.

Pierce 1977

Pierce, R. J. 1977. "Wetland Plants of the Eastern United States," U.S. Army Engineer Division, North Atlantic, NY.

Plumb 1981

Plumb, R. H., Jr. 1981. "Procedure for Handling and Chemical Analysis of Sediment and Water Samples," Technical Report EPA/CE-81-1, U.S. Army Engineer Waterways Experiment Station, Vicksburg, MS.



## Poindexter 1988

Poindexter, M. E. 1988. "Current District Dredged Material Dewatering Practices," Environmental Effects of Dredging Program Technical Note EEDP-06-4, U.S. Army Engineer Waterways Experiment Station, Vicksburg, MS. <http://el.ercd.usace.army.mil/dots/pdfs/eedp06-4.pdf>

## Poindexter 1989

Poindexter, M. E. 1989. "Equipment Mobility in Confined Dredged Material Disposal Areas; Field Evaluations," Environmental Effects of Dredging Program Technical Note EEDP-09-4, U.S. Army Engineer Waterways Experiment Station, Vicksburg, MS. <http://el.ercd.usace.army.mil/dots/pdfs/eedp09-4.pdf>

## Poindexter-Rollings 1989

Poindexter-Rollings, M. E. 1989. "Storage Capacity Evaluation for Craney Island Expansion Alternatives," Technical Report EL-89-6. U.S. Army Engineer Waterways Experiment Station, Vicksburg, MS. <http://www.dtic.mil/dtic/tr/fulltext/u2/a208124.pdf>

## Poindexter-Rollings 1990

Poindexter-Rollings, M. E. 1990. "Methodology for Analysis of Subaqueous Mounds," Technical Report D-90-2, U.S. Army Engineer Waterways Experiment Station, Vicksburg, MS. <http://el.ercd.usace.army.mil/elpubs/pdf/trd90-2.pdf>

## Poindexter-Rollings and Stark 1989

Poindexter-Rollings, M. E., and Stark, T. D. 1989. "PCDDF89 – Updated Computer Model to Evaluate Consolidation/Desiccation of Soft Soils," Environmental Effects of Dredging Program Technical Note EEDP-02-10, U.S. Army Engineer Waterways Experiment Station, Vicksburg, MS. <http://el.ercd.usace.army.mil/dots/pdfs/eedp02-10.pdf>

## Pollack 1968

Pollack, J. W. 1968. "The Effect of Chemical Flocculants on Dredging Overflows from the Hopper Dredge MARKAM," *Dredging Water Quality Problems in the Great Lakes*, Vol 7, Appendix C3, pp 1-93.

## Pope, Lewis, and Welp 1996

Pope, J., Lewis, R. D., and Welp, T. 1996. "Beach and Underwater Occurrences of Ordnance at a Former Defense Site: Erie Army Depot, Ohio," Technical Report CERC-96-1, U.S. Army Engineer Waterways Experiment Station, Vicksburg, MS. <http://chl.ercd.usace.army.mil/Media/7/6/9/CERC-TR-96-1.pdf>

## Pope et al. 1996

Pope, J., Lewis, R. D., Morang, A., and Welp, T. 1996. "A Pilot Study to Characterize Ordnance Contamination Within the Sea Bright, New Jersey, Sand Borrow Site," Technical Report CERC-96-8, U.S. Army Corps of Engineers Waterways Experiment Station, Vicksburg, MS. <http://acwc.sdp.sirsi.net/client/search/asset/1001125>

EM 1110-2-5025

31 Jul 15

Price, Brannon, and Myers 1997

Price, C. B., Brannon, J. M., and Myers, T. E. 1997. "Development of Laboratory Procedures to Predict Volatile Losses from Contaminated Sediments," *Environmental Effects of Dredging Technical Notes* EEDP-02-23, U.S. Army Engineer Waterways Experiment Station, Vicksburg, MS. <http://el.erdc.usace.army.mil/dots/pdfs/eedp02-23.pdf>

Price, Brannon, and Yost 1999

Price, C. B., Brannon, J. M., and Yost, S. L. 1999. "Prediction of Volatile Losses from Contaminated Exposed Sediments," *Environmental Effects of Technical Note* EEDP-02-26, U.S. Army Engineer Waterways Experiment Station, Vicksburg, MS. <http://el.erdc.usace.army.mil/dots/pdfs/eedp02-26.pdf>

Priest 1981

Priest, W. L. 1981. "The Effects of Dredging Impacts on Water Quality and Estuarine Organisms: A Literature Review," Virginia Institute of Marine Science Special Report in Applied Marine Science and Ocean Engineering, No. 247, pp 240-266.

Pritchard and Carpenter 1960

Pritchard, D. W., and Carpenter, J. H. 1960. "Measurement of Turbulent Diffusion in Estuarine and Inshore Waters," *Bulletin of the International Association of Science and Hydrology*, Vol 20, pp 37-50.

Profiles Research and Consulting Groups, Inc., 1980

Profiles Research and Consulting Groups, Inc. 1980. "Seasonal Restrictions on Dredging Projects by NMFS in the Northeast," Vol 1, prepared for Environmental Assessment Branch, U.S. Department of Commerce, NOAA, National Marine Fisheries Service.

Puckette 1998

Puckette, T. P. 1998. "Evaluation of Dredged Material Plumes: Physical Monitoring Techniques," *DOER Technical Notes Collection* (ERDC TN-DOER-E5), U.S. Army Engineer Waterways Experiment Station, Vicksburg, MS. <http://el.erdc.usace.army.mil/elpubs/pdf/doere5.pdf>

Pullen and Naqvi 1983

Pullen, E. J., and Naqvi, S. M. 1983. "Biological Impacts on Beach Replenishment and Borrowing," *Shore and Beach*, Vol. 51, pp 27-31.

Ray 2008

Ray, G. L. 2008. "Thin Layer Placement of Dredged Material on Coastal Wetlands: A Review of the Technical and Scientific Literature," ERDC/EL-TN-07-1, U.S. Army Engineer Research and Development Center, Vicksburg, MS. <http://el.erdc.usace.army.mil/elpubs/pdf/eltn07-01.pdf>

Raymond 1983

Raymond, G. L. 1983. "Field Study of the Sediment Resuspension Characteristics of Selected Dredges," *Proceedings of the 15<sup>th</sup> Annual Texas A&M Dredging Seminar*, Texas A&M University, College Station, TX.



Raymond 1984

Raymond, G. L. 1984. "Techniques to Reduce the Sediment Resuspension Caused by Dredging," Miscellaneous Paper HL-84-3, U.S. Army Engineer Waterways Experiment Station, Vicksburg, MS.

Rakocinski et al. 1996

Rakocinski, C. F., Heard, R. W., LeCroy, S. E., McLelland, J. A., and Simons, T. 1996. "Responses by Macrobenthic Assemblages to Extensive Beach Restoration at Perdido Key, Florida, U.S.A.," *Journal of Coastal Research* Vol 12, pp 326-353.

Reilly and Bellis 1978

Reilly, F. J., Jr., and Bellis, V. J. 1978. "A Study of the Ecological Impact of Beach Nourishment with Dredged Materials on the Intertidal Zone," Technical Report No. 4, Institute for Coastal and Marine Resources, East Carolina University, Greenville, NC.

Reilly and Bellis 1983

Reilly, F. J., Jr., and Bellis, V. J., 1983. "The Ecological Impact of Beach Nourishment with Dredged Materials on the Intertidal Zone at Bogue Banks, North Carolina," Miscellaneous Report 83-3, U.S. Army Engineer Coastal Engineering Research Center, Fort Belvoir, VA.

Reine, Dickerson, and Clarke 1998

Reine, K. J., Dickerson, D. D., and Clarke, D. G. 1998. "Environmental Windows Associated with Dredging Operations," *DOER Technical Notes Collection* (ERDC TN-DOER-E2), U.S. Army Engineer Research and Development Center, Vicksburg, MS. <http://el.erdc.usace.army.mil/elpubs/pdf/doere2.pdf>

Rhoads and Boyer 1982

Rhoads, D. C., and Boyer, L. F. 1982. "The Effects of Marine Benthos on Physical Properties of Sediments, A Successional Perspective," *Animal-Sediment Relations*, Plenum, pp 3-52.

Rhoads, McCall, and Yingst 1978

Rhoads, D. C., McCall, P. L., and Yingst, J. Y. 1978. "Disturbance and Production on the Estuarine Seafloor," *American Scientists*, Vol 66, pp 577-586.

Rhoads, Muramoto, and Ward 1996

Rhoads, D. C., Muramoto, J. A., and Ward, R. 1996. "A Review of Sensors Appropriate for Efficient Assessment of Submerged Coastal Habitats and Biological Resource," Technical Report EL-96-10, U.S. Army Engineer Waterways Experiment Station, Vicksburg, MS.

Richardson 1984

Richardson, T. W. 1984. "Agitation Dredging: Lessons and Guidelines from Past Projects," Technical Report HL-84-6, U.S. Army Engineer Waterways Experiment Station, Vicksburg, MS.

EM 1110-2-5025

31 Jul 15

Riley et al. 1994

Riley, M. Biswas, G., Boatman, C., Brockhaus, R., Utting, M., and Hotchkiss, D. 1994. "Groundwater Model Simulation of Chemical Transport from a Nearshore Confined Sediment Disposal Facility, *Proceedings of Second International Conference on Dredging and Dredged Material Placement*, Orlando, FL, 14-16 November, 1994. E. C. McNair, ed., American Society of Civil Engineers, New York, 1517-1526.

Rishel, Boston, and Schmidt 1984

Rischel, H. L., Boston, T. M., and Schmidt, C. J. 1984. "Costs of Remedial Actions at Uncontrolled Hazardous Waste Sites," *Pollution Technology Review*, No. 15.

Ritchie 1970

Ritchie, D. E. 1970. "Fish," Chesapeake Bay Laboratory, *Gross Physical and Biological Effects of Overboard Spoil Disposal in Upper Chesapeake Bay*, National Resources Institute Special Report 3, University of Maryland, Solomons, MD, pp 50-59.

Ritchie and Menzel 1969

Ritchie, T. P., and Menzel, R. W. 1969. "Influence of Light on Larval Settlement of American Oysters," *Proceedings of the National Shell Fisheries Association*, Vol 59, pp 116-120.

Robertshaw, McLaughlin, and Love 1993

Robertshaw, S., McLaughlin, R. J., and Love, D. 1993. "Legal and Institutional Constraints on Aquaculture in Dredged Material Containment Areas," Technical Report EL-93-7, U.S. Army Engineer Waterways Experiment Station, Vicksburg, MS. <http://www.dtic.mil/cgi-bin/GetTRDoc?Location=U2&doc=GetTRDoc.pdf&AD=ADA266335>

Rogers 1969

Rogers, B. A. 1969. "Tolerance Levels of Four Species of Estuarine Fishes to Suspended Mineral Solids," M.S. thesis, University of Rhode Island, Kingston, RI.

Rogers 1976

Rogers, R. M. 1976. "Distribution of Meiobenthic Organisms in San Antonio Bay in Relation to Season and Habitat Disturbance," *Shell Dredging and Its Influence on Gulf Coast Environments*, Gulf Publications Company, Houston, TX, pp 92-108.

Rogers and Darnell 1973

Rogers, R. M., and Darnell, R. M. 1973. "The Effects of Shell Dredging on the Distribution of Meiobenthic Organisms in San Antonio Bay, Texas; Vol III: Environmental Assessment of Shell Dredging in San Antonio Bay, Texas," U.S. Army Engineer District, Galveston, Galveston, TX, pp 159-167.

Rollings 2000

Rollings, M. P. 2000. "Geotechnical Considerations in Contained Aquatic Disposal Design," *DOER Technical Notes Collection* (ERDC TN-DOER-N5), U.S. Army Engineer Research and Development Center, Vicksburg, MS. <http://el.ercd.usace.army.mil/elpubs/pdf/doern5.pdf>

Rosati 1998

Rosati, J. 1998. "The Silent Inspector System," *Proceedings of the 15th World Dredging Congress*, World Organization of Dredging Associations, pp. 93-104

Rosati and Howell 2001

Rosati, J., III, and Howell, G. 2001. "Uniform Corps Specification for Dump Scow Monitoring to Interface with Silent Inspector," *DOER Technical Bulletin Notes Collection*, Vol. 4, Number 4, December 2001, U.S. Army Engineer Research and Development Center, Vicksburg, MS. <http://el.erdc.usace.army.mil/dots/pdfs/drv4n4.pdf>

Rosati and Prickett 2001

Rosati, J., III, and Prickett, T. L. 2001. "Silent Inspector Implementation Procedures for Hopper and Pipeline Dredges," *DOER Technical Notes Collection*, ERDC TN-DOER-I6, U.S. Army Engineer Research and Development Center, Vicksburg, MS. <http://el.erdc.usace.army.mil/elpubs/pdf/doeri6.pdf>

Rosati and Welp 1999

Rosati, J., and Welp, T. 1999. "Case Studies: Monitoring Pipeline Dredges," *DOER Technical Notes Collection* ERDC TN-DOER-I1, U.S. Army Engineer Research and Development Center, Vicksburg, MS. <http://el.erdc.usace.army.mil/elpubs/pdf/doeri1.pdf>

Rose 1973

Rose, C. D. 1973. "Mortality of Market-sized Oysters (*Crassostrea virginica*) in the Vicinity of a Dredging Operation," *Chesapeake Science*, Vol 14, pp 135-138.

Rosenthal and Alderdice 1976

Rosenthal, H., and Alderdice, D. F. 1976. "Sublethal Effects of Environmental Stressors, Natural and Pollutional, on Marine Fish Eggs and Larvae," *Journal of the Fisheries Research Board of Canada*, Vol 33, pp 2047-2065.

Rubinstein, Gilliam, and Gregory 1984

Rubinstein, N. I., Gilliam, W. T., and Gregory, N. R. 1984. "Dietary Accumulation of PCBs from a Contaminated Sediment Source by a Demersal Fish Species (*Leiostomus xanthurus*)," Technical Report D-84-6, U.S. Army Engineer Waterways Experiment Station, Vicksburg, MS. <http://el.erdc.usace.army.mil/elpubs/pdf/trd84-6.pdf>

Sabol and Burczinski 1998

Sabol, B. M., and Burczinski, J. 1998. "Digital Echo Sounder System for Characterizing Vegetation in Shallow-Water Environments." *Proceedings of the 4<sup>th</sup> European Conference on Underwater Acoustics*. Rome, Italy, pp 165-171.

Sabol and Johnston 2001

Sabol, B. M., and Johnston, S. A. 2001. "Innovative Techniques for Improved Hydroacoustic Bottom Tracking in Dense Aquatic Vegetation," ERDC/EL MP-01-2, U.S. Army Engineer Research and Development Center, Vicksburg, MS. <http://el.erdc.usace.army.mil/elpubs/pdf/mpel01-2.pdf>

Sabol et al. 2002

Sabol, B. M., Melton, R. E., Chamberlain, R., Doering, P., and Haunert, K. 2002. "Evaluation of a Digital Echo Sounder System for Detection of Submerged Aquatic Vegetation," *Estuaries* 25, 1.

Saila et al. 1972

Saila, S. B., Pratt, S. D., and Polgar, T. T. 1972. "Results of Studies Related to Dredged Sediment in Rhode Island Sound." *Proceedings, Annual Northeastern-Regional Anti-Pollution Conference*, Newport, RI, pp 71-80.

Saila, Polgar, and Rogers 1968

Saila, S. B., Polgar, T. T., and Rogers, B. A. 1968. "Results of Studies Related to Dredged Sediment Dumping on Rhode Island Sound," *Proceedings of the Annual Northeastern Regulatory Anti-Pollution Conference*, pp 71-80.

Saila, Pratt, and Polgar 1972

Saila, S. B., Pratt, S. D., and Polgar, T. T. 1972. "Dredge Spoil Disposal in Rhode Island Sound," University of Rhode Island Marine Technical Report 2, Kingston, RI.

Salem and Krizek 1973

Salem, M. A., and Krizek, R. J. 1973. "Consolidation Characteristics of Dredging Slurries," *Journal of Waterways, Harbors, and Coastal Engineering Division*, American Society of Civil Engineers, Vol 99, No. WW4, pp 439-458.

Sales and Appy 1994

Sales, L. W., and Appy, R. G. 1994. "Restoration of Batiquitos Lagoon," Special Paper presented at *Dredging '94, Proceedings of the Second International Conference on Dredging and Dredged Material Placement*, November 1994, Lake Buena Vista, FL. E. C. McNair, Jr., ed., American Society of Civil Engineers, New York.

Saloman and Naughton 1977

Saloman, C. H., and Naughton, S. P. 1977. "Effects of Hurricane Eloise on the Benthic Fauna of Panama City Beach, Florida, U.S.A.," *Marine Biology*, Vol 42, pp 357-363.

Saloman and Naughton 1984

Saloman, C. H., and Naughton, S. P. 1984. "Beach Restoration with Offshore Dredged Sand: Effects on Nearshore Macrofauna," NOAA Technical Report NMFS-SEFC-133. [https://grunt.sefsc.noaa.gov/P\\_QryLDS/download/TM133\\_TM-133.pdf?id=LDS](https://grunt.sefsc.noaa.gov/P_QryLDS/download/TM133_TM-133.pdf?id=LDS)

Sanderson and McKnight 1986

Sanderson, W. H., and McKnight, A. L. 1986. "Survey of Equipment and Construction Techniques for Capping Dredged Material," Miscellaneous Paper D-86-6, U.S. Army Engineer Waterways Experiment Station, Vicksburg, MS. <http://el.erdc.usace.army.mil/elpubs/pdf/mpd86-6.pdf>

## Scheffner 1991

Scheffner, N. W. 1991. "A Generalized Approach to Site Classification - Dispersive or Non-Dispersive," Dredging Research Information Exchange Bulletin, Vol DRP-91-1, U.S. Army Engineer Waterways Experiment Station, Vicksburg, MS. <http://cirp.usace.army.mil/pubs/archive/TR-DRP-91-1.pdf>

## Scheffner et al. 1995

Scheffner, N. W., Thevenot, M. M., Tallent, J. R., and Mason, J. M. 1995. "LTFATE: A Model to Investigate the Long-Term Fate and Stability of Dredged Material Disposal Sites; User's Guide," Instruction Report DRP-95-1, U.S. Army Engineer Waterways Experiment Station, Vicksburg, MS. <http://chl.erdc.usace.army.mil/Media/7/8/6/DRP-IR-DRP-95-1.pdf>

## Schroeder 1983

Schroeder, P. R. 1983. "Chemical Clarification Methods for Confined Dredged Material Disposal," Technical Report D-83-2, U.S. Army Engineer Waterways Experiment Station, Vicksburg, MS. <http://el.erdc.usace.army.mil/dots/pdfs/mpd83-2/cover.pdf>

## Schroeder and Ammon 1984

Schroeder, P. R., and Ammon, D. C. 1984 "The Hydrologic Evaluation of Landfill Performance (HELP) Model: Volume I, Users Guide for Version I: Technical Resource Document for Public Comment, U.S. Army Engineer Waterways Experiment Station, Vicksburg, MS.

## Schroeder and Palermo 1990

Schroeder, P. R., and Palermo, M. R. 1990. "Automated Dredging and Disposal Alternatives Management System, Users Guide," Technical Note EEDP-06-12, U.S. Army Engineer Waterways Experiment Station, Vicksburg, MS.

## Schroeder et al. 2004

Schroeder, P. R., Palermo, M. R., Myers, T. E., and Lloyd, C. M. 2004. "The Automated Dredging and Disposal Alternatives Modeling System (ADDAMS)," *Environmental Effects of Dredging Technical Notes Collection* (ERDC/TN EEDP-06-12), U.S. Army Engineer Research and Development Center, Vicksburg, MS. <http://el.erdc.usace.army.mil/dots/pdfs/eedp06-12.pdf>

## Schubel and Carter 1978

Schubel, J. R., and Carter, H. H. 1978. "Field Investigations of the Nature, Degree, and Extent of Turbidity Generated by Open-Water Pipeline Disposal Operation," Technical Report D-78-30. U.S. Army Engineer Waterways Experiment Station, Vicksburg, MS. <http://el.erdc.usace.army.mil/elpubs/pdf/trd78-30/cover.pdf>

## Schubel and Wang 1973

Schubel, L. R., and Wang, L. C. 1973. "The Effects of Suspended Sediment on the Hatching Success of *Perca flavescens* (Yellow Perch), *Morone americana* (White Perch), *Morone saxatilis* (Striped Bass), and *Alosa pseudoharengus* (Alewife) Eggs," Special Report No. 30, Chesapeake Bay Institute, Johns Hopkins University, Baltimore, MD.

EM 1110-2-5025

31 Jul 15

Schubel, Carter, and Wise 1979

Schubel, J. R., Carter, H. H., and Wise, W. M. 1979. "Shrimping as a Source of Suspended Sediment in Corpus Christi Bay (Texas)," *Estuaries*, Vol 2, pp 201-203.

Schubel, Williams, and Wise 1977

Schubel, J. R., Williams, A. D., and Wise, W. M. 1977. "Suspended Sediment in the Chesapeake and Delaware Canal," Special Report 11, Ref. 77-7, Marine Science Research Center, State University of New York, Stony Brook, NY.

Science Applications International Corporation 1985

Science Applications International Corporation. 1985. "REMOTS Survey of Zones of Siting Feasibility, Puget Sound, Washington." Report No. SAIC-85/7526&91, prepared by Science Applications International Corporation, Newport, RI, for Cooper Consulting, Inc., Bellevue, WA.

SCS Engineers 1977

SCS Engineers. 1977. "Feasibility of Inland Disposal of Dewatered Dredged Material: A Literature Review," Technical Report D-77-33, U.S. Army Engineer Waterways Experiment Station, Vicksburg, MS. <http://el.erdc.usace.army.mil/elpubs/pdf/trd77-33.pdf>

Schemnitz 1980

Schemnitz, S. D., ed. 1980. *Wildlife Management Techniques Manual*, The Wildlife Society, Washington, DC, 686 pp.

Semmler 1990

Semmler, J. A. 1990. "PCB Volatilization from Dredged Material, Indiana Harbor, Indiana," *Environmental Effects of Dredging Technical Notes* EEDP-02-12, U.S. Army Engineer Waterways Experiment Station, Vicksburg, MS. <http://el.erdc.usace.army.mil/dots/pdfs/eedp02-12.pdf>

Shaw, Whiteside, and Ng 1998

Shaw, J. K., Whiteside, P. G. D., and Ng, K. C. 1998. "Contaminated Mud in Hong Kong: A Case Study of Contained Seabed Disposal." *Proceedings of the Fifteenth World Dredging Congress, Dredging into the 21st Century and Exhibition*, 28 June - 2 July 1998, Las Vegas, NV. R. E. Randall, ed., Western Dredging Association, pp 799-810.

Sherk 1972

Sherk, J. A. 1972. "Current Status of the Knowledge of the Biological Effects of Suspended and Deposited Sediments in Chesapeake Bay," *Chesapeake Science*, Vol 13, Supplement, pp 137-144.

Sherk, O'Connor, and Neumann 1975

Sherk, J. A., O'Connor, J. M., and Neumann, D. A. 1975. "Effects of Suspended and Deposited Sediments on Estuarine Environments," *Estuarine Research*, Vol 11, Academic Press, New York, pp 541-558.



Shields, Schroeder, and Palermo 1989

Shields, F. D., Schroeder, P. R., and Palermo, M. R. 1989, "Economic Optimization of Confined Disposal Area Dimensions," EEDP-06-5. U.S. Army Engineer Waterways Experiment Station, Vicksburg, MS. <http://el.erdc.usace.army.mil/dots/pdfs/eedp06-5.pdf>

Shulenberg 1970

Shulenberg, E. 1970. Responses of *Gemma gemma* to a Catastrophic Burial," *Veliger*, Vol 13, pp 163-170.

Silberhorn 1976

Silberhorn, G. M. 1976. *Tidal Wetland Plants of Virginia*, VIMS Science Education Series No. 19, Virginia Institute of Marine Science, Gloucester Point, VA, 86 pp.

Simmers, Rhett, and Lee 1986

Simmers, J. W., Rhett, R. G., and Lee, C. R. 1986. "Upland Animal Bioassays of Dredged Material," *Environmental Effects of Dredging Technical Notes* EEDP-02-2, U.S. Army Engineer Waterways Experiment Station, Vicksburg, MS. <http://el.erdc.usace.army.mil/dots/pdfs/eedp06-5.pdf>

Simmons 1966

Simmons, H. B. 1966. "Field Experience in Estuaries," *Estuary and Coastline Hydrodynamics*, Chap 16, A. T. Ippen, ed., McGraw-Hill, New York, pp 673-690.

Simon and Dauer 1977

Simon, L. L., and Dauer, D. M. 1977. "Reestablishment of a Benthic Community Following Natural Defaunation," *Ecology of Marine Benthos*, University of South Carolina Press, Columbia, SC, pp 139-154.

Sindermann et al. 1982

Sindermann, C. J., Esser, S. C., Gould, E., McCain, B. B., McHugh, J. L., Morgan, R. P., Murchelano, R. A., Sherwood, M. J., and Spitzer, P. R. 1982. "Effects of Pollutants on Fishes," *Ecological Stress and the New York Bight: Science and Management*, Estuarine Research Federation, Columbia, SC, pp 23-38.

Skjei 1976

Skjei, S. S. 1976. "Socioeconomic Aspects of Dredged Material Disposal: The Creation of Recreation Land in Urban Areas," Contract Report D-76-06, U.S. Army Engineer Waterways Experiment Station, Vicksburg, MS. <http://el.erdc.usace.army.mil/elpubs/pdf/crd76-6/cover.pdf>

Skogerboe and Lee 1987

Skogerboe, J. G., and Lee, C. R. 1987. "Upland Disposal Site Management for Surface Runoff Water Quality," *Environmental Effects of Dredging Technical Notes* EEDP-02-3, U.S. Army Engineer Waterways Experiment Station, Vicksburg, MS. <http://el.erdc.usace.army.mil/dots/pdfs/eedp02-3.pdf>

EM 1110-2-5025

31 Jul 15

Slotta et al. 1973

Slotta, L. S., Sollitt, C. K., Bella, D. A., Hancock, D. R., McCauley, J. E., and Parr, R. 1973. "Effects of Hopper Dredging and In-Channel Spoiling in Coos Bay, Oregon," Schools of Engineering and Oceanography, Oregon State University, Corvallis, OR.

Smart and Laidlaw 1977

Smart, D. L., and Laidlaw, I. M. S. 1977. "An Evaluation of Some Fluorescent Dyes for Water Tracing," *Water Resource Research*, Vol 13, pp 15-33.

Smith 1978

Smith, H. K. 1978. "Introduction to Habitat Development on Dredged Material," Technical Report DS-78-19, U.S. Army Engineer Waterways Experiment Station, Vicksburg, MS.

Smith et al. 1976

Smith, J. M., Phipps, J. B., Schermer, E. D., and Samuelson, D. F. 1976. "Impact of Dredging on Water Quality in Grays Harbor, Washington," Proceedings of the Specialty Conference on Dredging and Its Environmental Effects, American Society of Civil Engineers, pp 512-528.

Soots and Landin 1978

Soots, R. F., Jr., and Landin, M. C. 1978. "Development and Management of Avian Habitat on Dredged Material Islands," Technical Report DS-78-18, U.S. Army Engineer Waterways Experiment Station, Vicksburg, MS.

Souder et al. 1978

Souder, P. S., Jr., Tobias, L., Imperial, J. F., and Mushal, F. C. 1978. "Dredged Material Transport Systems for Inland Disposal and/or Productive Use Concepts," Technical Report D-78-28, U.S. Army Engineer Waterways Experiment Station, Vicksburg, MS. <http://el.erdc.usace.army.mil/elpubs/pdf/trd78-28/cover.pdf>

Sowers 1979

Sowers, G. F. 1979. *Soil Mechanics and Foundations: Geotechnical Engineering*, 4th Edition, Macmillan, New York, p 82.

Spaine, Llopis, and Perrier 1978

Spaine, P. A., Llopis, J. L., and Perrier, E. R. 1978. "Guidance for Land Improvement Using Dredged Material," Technical Report DS-78-21, U.S. Army Engineer Waterways Experiment Station, Vicksburg, MS. <http://el.erdc.usace.army.mil/elpubs/pdf/ds78-21/ds78-21.pdf>

Spigolon 1993

Spigolon, S. J. 1993. "Geotechnical Site Investigation Strategy for Dredging Projects," Contract Report DRP-93-3, U.S. Army Engineer Waterways Experiment Station, Vicksburg, MS. <http://el.erdc.usace.army.mil/e2d2/pdfs/drp93-3-R1.pdf>



## Stafford, Simmers, and Rhett 1987

Stafford, E. A., Simmers, J. W., and Rhett, R. G. 1987. "Contaminant Mobility at Dredged Material Disposal Sites. Assessment Using Invertebrates Naturally Colonizing the Sites." Proceedings of the International Conference on Heavy Metals in the Environment, New Orleans, LA. Consultants Ltd. 424-426.

## Stanley and DeWitt 1983

Stanley, J. G., and DeWitt, R. 1983. "Species Profiles: Life Histories and Environmental Requirements of Coastal Fishes and Invertebrates (North Atlantic)-Hard Clam," Technical Report EL-82-4, U.S. Army Engineer Waterways Experiment Station, Vicksburg, MS (also published as FWS/OBS-82/11.18, U.S. Fish and Wildlife Service, Washington, DC).

[http://www.nwrc.usgs.gov/wdb/pub/species\\_profiles/82\\_11-018.pdf](http://www.nwrc.usgs.gov/wdb/pub/species_profiles/82_11-018.pdf)

## Stark 1991

Stark, T. D. 1991. "Program Documentation and User's Guide: PCDDF89, Primary Consolidation and Desiccation of Dredged Fill," Instruction Report D-91-1, U.S. Army Engineer Waterways Experiment Station, Vicksburg, MS. <http://el.ercd.usace.army.mil/dots/pdfs/ird91-1.pdf>

## Stark 1995

Stark, T. D. 1995. Soil-structure interaction parameters for structures/cemented silts. Technical Report ITL-95-5. U.S. Army Engineer Waterways Experiment Station, Vicksburg, MS.

<http://www.dtic.mil/cgi-bin/GetTRDoc?AD=ADA299101>

## Stern and Stickle 1978

Stern, E. M., and Stickle, W. B. 1978. "Effects of Turbidity and Suspended Material in Aquatic Environments: Literature Review," Technical Report D-78-21, U.S. Army Engineer Waterways Experiment Station, Vicksburg, MS. <http://el.ercd.usace.army.mil/elpubs/pdf/trd78-21.pdf>

## Stevens 1981

Stevens, B. G. 1981. "Dredging-Related Mortality of Dungeness Crabs Associated with Four Dredges Operating in Grays Harbor, Washington," Report No. DA-79-45, Washington Department of Fisheries and U.S. Army Engineer District, Seattle, Seattle, WA.

## Stickney and Perlmutter 1975

Stickney, R. R., and Perlmutter, D. 1975. "Impact of Intracoastal Waterway Maintenance Dredging on a Mud Bottom Benthos Community," *Biological Conservation*, Vol 7, pp 211-226.

## Streeter 1971

Streeter, V. L. 1971. *Fluid Mechanics*, 5th ed., McGraw-Hill, New York.

## Sturgis 1990

Sturgis, T. L. 1990. "Guidance for Contracting Biological and Chemical Evaluations of Dredged Material," Technical Report D-90-10, U.S. Army Engineer Waterways Experiment Station, Vicksburg, MS. <http://el.ercd.usace.army.mil/elpubs/pdf/trd90-10.pdf>

EM 1110-2-5025

31 Jul 15

Sturgis, Lee, and Langan 1997

Sturgis, T. C., Lee, C. R., and Langan, P. 1997. "Manufactured Soil from Mobile Harbor Dredged Material," *Proceedings of the International Workshop on Dredged Material Beneficial Uses*, July 28-August 1, 1997, Baltimore, MD. M. C. Landin, ed., U.S. Army Engineer Waterways Experiment Station, Vicksburg, MS, p. 46.

Sturgis, Lee, and Taplin 1997

Sturgis, T. C., Lee, C. R., and Taplin, K. A. 1997. "Manufactured Soil from St. Lucie Muck," *Proceedings of the International Workshop on Dredged Material Beneficial Uses*, 28 July - 1 August 1997, Baltimore, MD. M. C. Landin, ed., U.S. Army Engineer Waterways Experiment Station, Vicksburg, MS, p. 48.

Sustar, Wakeman, and Ecker 1976

Sustar, J. R., Wakeman, T. H., and Ecker, R. M. 1976. "Sediment-Water Interaction During Dredging Operations," *Proceedings of the Specialty Conference on Dredging and Its Environmental Effects*, American Society of Civil Engineers, pp 736-767.

Sutherland 1981

Sutherland, J. P. 1981. "The Fouling Community at Beaufort, North Carolina: A Study in Stability," *American Naturalist*, Vol 118, pp 499-519.

Swafford and Gorini 1994

Swafford, R., and Gorini, R. F. 1994. "Site Selection for Beneficial Uses of Dredged Material in Galveston Bay, TX, USA," *Proceedings of the Second International Conference on Dredging and Dredged Material Placement*, November 1994, Lake Buena Vista, FL. E. C. McNair, Jr., ed., American Society of Civil Engineers, New York, pp 399-409.

Tagatz 1976

Tagatz, M. 1976. "Effect of Mirex on Predator-Prey Interaction in an Experimental Estuarine Ecosystem," *Transactions of the American Fisheries Society*, Vol 105, pp 546-549.

Tatem and Johnson 1978

Tatem, H. E., and Johnson, J. H. 1978. "Aquatic Disposal Field Investigations, Duwamish Waterway Disposal Site, Puget Sound, Washington: Evaluative Summary," Technical Report D-77-24, U.S. Army Engineer Waterways Experiment Station, Vicksburg, MS. <http://el.erdc.usace.army.mil/elpubs/pdf/trd77-24-G.pdf>

Tavolaro et al. 2007

Tavolaro, J. F., Wilson, J. R., Welp, T. L., Clausner, J. E., and Premo, A. Y. 2007. "Overdepth Dredging and Characterization Depth Recommendations," EEDP-04-37, U.S. Army Engineer Research and Development Center, Vicksburg, MS. <http://el.erdc.usace.army.mil/elpubs/pdf/eedp04-37.pdf>

Taylor and Saloman 1968

Taylor, J. L., and Saloman, C. H. 1968. "Some Effects of Hydraulic Dredging and Coastal Development in Boca Ciaga Bay, Florida," *Fishery Bulletin*, Vol 67, pp 213-241.

## Teeter 1992

Teeter, A. M. 1992. "Erosion of Cohesive Dredged Material in Open-Water Disposal Sites," Dredging Research Technical Note DRP-1-07, U.S. Army Engineer Waterways Experiment Station, Vicksburg, MS. <http://www.dtic.mil/cgi-bin/GetTRDoc?Location=U2&doc=GetTRDoc.pdf&AD=ADA365381>

## Teeter 2000

Teeter, A. M. 2000. "Underflow Spreading from an Open-Water Pipeline Disposal," *Doer Technical Notes Collection* (ERDC TN-DOER-N7), U.S. Army Engineer Research and Development Center, Vicksburg, MS. <http://el.ercd.usace.army.mil/elpubs/pdf/doern7.pdf>

## Tegelberg and Arthur 1977

Tegelberg, H., and Arthur, R. 1977. "Distribution of Dungeness Crabs (*Cancer magister*) in Grays Harbor, and Some Effects of Channel Maintenance Dredging; Appendix N, Maintenance Dredging and Environment of Grays Harbor, Washington," U.S. Army Engineer District, Seattle, Seattle, WA.

## Tetra Tech, Inc. and Averett 1994

Tetra Tech, and Averett, D. 1994. "Options for Treatment and Disposal of Contaminated Sediments from New York/ New Jersey Harbor," Miscellaneous Paper EL-94-1, U.S. Army Engineer Waterways Experiment Station, Vicksburg, MS. <http://el.ercd.usace.army.mil/elpubs/pdf/mpel94-1.pdf>

## Terzaghi and Peck 1967

Terzaghi, K., and Peck, R. B. 1967. "Soil Mechanics in Engineering Practice," 2nd Edition, John Wiley, New York.

## Thayer, Kenworthy, and Fonseca 1984

Thayer, G. W., Kenworthy, W. J., and Fonseca, M. S. 1984. "The Ecology of Eelgrass Meadows of the Atlantic Coast: A Community Profile," FWSIOBS-84/02, U.S. Fish and Wildlife Service, Washington, DC.

## Thevenot, Prickett, and Kraus 1992

Thevenot, M. M., Prickett, T. L., and Kraus, N. C., ed. 1992. "Tylers Beach, Virginia, Dredged Material Plume Monitoring Project, 27 September to 4 October 1991," Technical Report DRP-92-7, U.S. Army Engineer Waterways Experiment Station, Vicksburg, MS. <http://www.dtic.mil/dtic/tr/fulltext/u2/a261036.pdf>

## Thibodeaux 1989

Thibodeaux, L. J. 1989. "Theoretical Models for Evaluation of Volatile Emissions to Air During Dredged Material Disposal with Applications to New Bedford Harbor, Massachusetts," Miscellaneous Paper EL-89-3, U.S. Army Engineer Waterways Experiment Station, Vicksburg, MS. <http://el.ercd.usace.army.mil/e2d2/pdfs/mpel89-3.pdf>

EM 1110-2-5025

31 Jul 15

Thom and Wellman 1996

Thom, R. M., and Wellman, K. F. 1996. "Planning Aquatic Ecosystem Restoration Monitoring Programs," IWR Report 96-R-23, U.S. Army Engineer Waterways Experiment Station, Vicksburg, MS. <http://www.iwr.usace.army.mil/Portals/70/docs/iwrreports/96r23.pdf>

Thorhaug 1981

Thorhaug, A. 1981. "Seagrasses in the Gulf of Mexico, Florida, and Caribbean Including Restoration and Mitigation of Seagrasses," *Proc. U.S. Fish and Wildlife Service Workshop on Coastal Ecosystems of the Southeastern United States*, pp 161-178.

Thorhaug 1985

Thorhaug, A. 1985. "Large Scale Seagrass Restoration in a Damaged Estuary," *Marine Pollution Bulletin*, Vol. 16, No. 2, pp 55-62.

Thunhorst 1993

Thunhorst, G. A. 1993. "Wetland Planting Guide for the Northeastern United States: Plants for Wetland Creation, Restoration, and Enhancement," Environmental Concern Inc., St. Michaels, MD.

Togashi 1983

Togashi, H. 1983. "Sand Overlaying for Sea Bottom Sediment Improvement by Conveyor Barge," *Management of Bottom Sediments Containing Toxic Substances: Proceedings of the 7th US/Japan Experts meeting*, prepared for the U.S. Army Corps of Engineers Waters Resources Support Center by the U.S. Army Engineer Waterways Experiment Station, Vicksburg, MS, pp 59-78.

Tramontano and Bohlen 1984

Tramontano, J. M., and Bohlen, W. F. 1984. "The Nutrient and Trace Metal Geochemistry of a Dredge Plume," *Estuarine, Coastal, and Shelf Science*, Vol 18, pp 385-401.

Trueman and Foster-Smith 1976

Trueman, E. R., and Foster-Smith, R. L. 1976. "The Mechanisms of Burrowing of *Sipunculus nudus*," *Journal of Zoology*, London, Vol 179, pp 373-386.

Truitt 1986

Truitt, C. L. 1986. "Fate of Dredged Material During Open Water Disposal," Environmental Effects of Dredging Technical Note EEDP-01-2, U.S. Army Engineer Waterways Experiment Station, Vicksburg, MS. <http://el.erdc.usace.army.mil/dots/pdfs/eedp01-2.pdf>

Truitt 1987

Truitt, C. L. 1987. "Engineering Considerations for Subaqueous Dredged Material Capping - Background and Preliminary Planning," Environmental Effects of Dredging Technical Note EEDP-01-3, U.S. Army Engineer Waterways Experiment Station, Vicksburg, MS. <http://el.erdc.usace.army.mil/dots/pdfs/eedp01-3.pdf>

Tubman 1994a

Tubman, M. W. 1994a. "The PLUme MEasurement System (PLUMES); A Commercially Available System," Technical Note DRP-1-16, U.S. Army Engineer Waterways Experiment Station, Vicksburg, MS. [Technical Note DRP-1-16](#)

Tubman 1994b

Tubman, M. W. 1994b. "The PLUme MEasurement System (PLUMES); Operational and Data Processing Procedures for Deepwater Monitoring," Technical Note DRP-1-18, U.S. Army Engineer Waterways Experiment Station, Vicksburg, MS.  
<http://el.erdc.usace.army.mil/elpubs/pdf/drp1-18.pdf>

Tubman 1995

Tubman, M. W. 1995. "Plume Measurement System (PLUMES) Technical Manual and Data Analysis Procedures," Technical Report DRP-95-1, U.S. Army Engineer Waterways Experiment Station, Vicksburg, MS. <http://www.dtic.mil/cgi-bin/GetTRDoc?Location=U2&doc=GetTRDoc.pdf&AD=ADA293040>

Tubman, Brumley, and Puckette 1994

Tubman M. W., Brumley, B., and Puckette, P. T. 1994. "Deep-water Dredged-Material Disposal Monitoring Offshore of San Francisco Using the PLUme MEasurement System (PLUMES)," *Dredging '94, Proceedings of the Second International Conference on Dredging and Dredged Material Placement*, Lake Buena Vista, FL.

Tubman and Corson 2000

Tubman, M. W., and Corson, W. D. 2000. "Acoustic Monitoring of Dredging-Related Suspended-Sediment Plumes," *DOER Technical Notes Collection (ERDC TN-DOER-E7)*, U.S. Army Engineer Research and Development Center, Vicksburg, MS.  
<http://el.erdc.usace.army.mil/elpubs/pdf/doere7.pdf>

Turner 1977

Turner, T. M. 1977. "Dredging Systems and the Basic Dredge Laws," presented at Florida Atlantic University, 1972, and Personal Communication, 1977.

Turner 1996

Turner, T. 1996. *Fundamentals of Hydraulic Dredging*" American Society of Civil Engineers, Reston, VA.

Uetz et al. 1979

Uetz, G. W., Van Der Laan, K. L., Summers, G. F., Gibson, P. A. K., and Getz, L. L. 1979. "The Effects of Flooding on Floodplain Arthropod Distribution, Abundance and Community Structure," *American Midland Naturalist*, Vol. 101, No. 2, pp 286-299.

Urban Research and Development Corporation 1980

Urban Research and Development Corporation. 1980. "Recreation Carrying Capacity Handbook: Methods and Techniques for Planning, Design, and Management," Instruction Report R-80-1, U.S. Army Waterways Experiment Station, Vicksburg, MS.

EM 1110-2-5025

31 Jul 15

USACE 1954

U.S. Army Corps of Engineers. 1954. "The Hopper Dredge, Its Development and Operation," U.S. Army Corps of Engineers, Washington, DC.

USACE 1985

U.S. Army Corps of Engineers. "Dredged Material Beneficial Uses," Engineer Manual 1110-2-5026, Office, Chief of Engineers, Washington, DC, 1985.

USACE 1987

U.S. Army Corps of Engineers. 1987. "Environmental Engineering for Deep-Draft Navigation Projects," Engineer Manual 1110-2-1202, U.S. Army Corps of Engineers, Washington, DC.

USACE 1995

U.S. Army Corps of Engineers. 1995. "Coastal Geology," Engineer Manual 1110-2-1810, U.S. Army Corps of Engineers, Washington, DC.

USACE 2003a

U.S. Army Corps of Engineers. 2003. "Contract Specifications for Hopper Dredge Use." U.S. Army Engineer District, Jacksonville.

USACE Navigation Data Center 2000

U.S. Army Corps of Engineers Navigation Data Center. 2000. "Dredging Information System."

USACE Sea Turtle Data Warehouse 2006

U.S. Army Corps of Engineers Sea Turtle Data Warehouse. 2006. <http://el.ercd.usace.army.mil/seaturtles/intro.cfm>

U.S. Army Engineer District, Portland 1982

U.S. Army Engineer District, Portland. 1982. "Water Quality Effects of Hopper Dredging on Isthmus Slough During Late Summer Temperature Regimes," Portland, OR.

U.S. Army Engineer District, San Francisco 1976

U.S. Army Engineer District, San Francisco. 1976. "Dredge Disposal Study, San Francisco Bay and Estuary, Appendix C," San Francisco, CA.

U.S. Army Engineer District, Wilmington 1996

U.S. Army Engineer District, Wilmington. 1996. "Dredging Inspectors' Environmental Handbook," U.S. Army Corps of Engineers, Wilmington, NC.

U.S. Army Engineer Division, New England 1990

U.S. Army Engineer Division, New England. 1990. "New Bedford Harbor Superfund Pilot Study, Evaluation of Dredging and Dredged Material Disposal," U.S. Army Engineers Division, New England, Waltham, MA.

U.S. Army Engineer Waterways Experiment Station 1956

U.S. Army Engineer Waterways Experiment Station. 1956. "Investigation of Underseepage and Its Control, Lower Mississippi River Levees," Technical Memorandum No. 3-424, Vicksburg, MS.

U.S. Army Engineer Waterways Experiment Station 1960

U.S. Army Engineer Waterways Experiment Station. 1960. "The Unified Soil Classification System," Technical Memorandum No. 3-357, U.S. Army Engineer Waterways Experiment Station, Vicksburg, MS.

U.S. Department of Defense (1964)

U.S. Department of Defense. 1964. "Military Standard: Subgrade, Subbase, and Test Method for Pavement Base-Course Materials," MIL-STD-621A, Washington, D.C.

U.S. Department of the Army 1987

U.S. Department of the Army. 1987. "Field Manual FM 5-530: Materials Testing," Department of the Army FM 5-530, Department of the Navy NAVFAC MO-330, and Department of the Air Force AFM 89-3, Washington, D.C. [http://armypubs.army.mil/doctrine/DR\\_pubs/dr\\_a/pdf/fm5\\_472.pdf](http://armypubs.army.mil/doctrine/DR_pubs/dr_a/pdf/fm5_472.pdf)

U.S. Department of Transportation 1994

U.S. Department of Transportation. 1994. "The Dredging Process in the United States: An Action Plan for Improvement," by the Interagency Working Group on the Dredging Process, Maritime Administration, Washington, DC. [http://water.epa.gov/type/oceb/oceandumping/dredgedmaterial/upload/oceans\\_ndt\\_publications\\_1994\\_report.pdf](http://water.epa.gov/type/oceb/oceandumping/dredgedmaterial/upload/oceans_ndt_publications_1994_report.pdf)

USEPA 1979

U.S. Environmental Protection Agency. 1979. "Methods for Chemical Analysis of Water and Wastes," EPA Monitoring and Support Laboratory, 1979, Cincinnati, OH.

USEPA 1986

U.S. Environmental Protection Agency. 1986. "Ocean Dumping Site Designation Delegation Handbook," Office of Marine and Estuarine Protection, Washington, DC.

USEPA 1987

U.S. Environmental Protection Agency. 1987. "Handbook: Remedial action at waste disposal sites (revised)," EPA 540/2-85/001, Hazardous Waste Engineering Research Laboratory, Cincinnati, Ohio

USEPA 1994

U.S. Environmental Protection Agency. 1994. "Remediation Guidance Document," EPA 905-R94-003, Assessment and Remediation of Contaminated Sediments Program, Great Lakes National Program Office, Chicago, IL. <http://www.epa.gov/glnpo/arcs/EPA-905-B94-003/EPA-905-B94-003.html>



EM 1110-2-5025

31 Jul 15

USEPA 1998

U.S. Environmental Protection Agency. 1998. "Guidelines for Ecological Risk Assessment," *Federal Register*, Vol 63(93), pp 26845-26924.

USEPA 2001

U.S. Environmental Protection Agency. 2001. "Methods for Collection, Storage and Manipulation of Sediments for Chemical and Toxicological Analyses," Technical Manual EPA 823-B-01-002, U.S. Environmental Protection Agency, Office of Water, Washington, DC.

<http://www.epa.gov/waterscience/cs/collection.html>

USEPA 2005

U.S. Environmental Protection Agency. 2005. "Contaminated Sediment Remediation Guidance for Hazardous Waste Sites," EPA-540-R-05-012, OSWER 9355.0-85, Office of Solid Waste and Emergency Response, U.S. Environmental Protection Agency, Washington, DC.

<http://www.epa.gov/superfund/resources/sediment/guidance.htm>

USEPA Office of Emergency and Remedial Response (OERR) 1989

U.S. Environmental Protection Agency Office of Emergency and Remedial Response. 1989. "Risk Assessment Guidance for Superfund: Volume I - Human Health Evaluation Manual (Part A)," EPA/540/1-89/002, Washington, DC.

U.S. Fish and Wildlife Service 1970

U.S. Fish and Wildlife Service. 1970. "Effects on Fish Resources of Dredging and Spoil Disposal in San Francisco and San Pablo Bays, California," Unnumbered Special Report, Washington, DC.

Valente and Fredette 2002

Valente, R. M., and Fredette, T. J. 2002. "Benthic Recolonization of a Capped Dredged Material Mound at an Open Water Disposal Site in Long Island Sound." *Proceedings of the Third Specialty Conference on Dredging and Dredged Material Disposal - Dredging '02 - Key Technologies for Global Prosperity*, 5-8 May 2002, Orlando, FL. Stephen Garbaciak, Jr., ed., American Society of Civil Engineers.

van't Hoff and Nooy van der Kolff (Editors) 2012

van't Hoff, J., and Nooy van der Kolff, A. (Editors). 2012. *Hydraulic Fill Manual for Dredging and Reclamation Works*, CRC Press/Balkema Taylor & Francis Group, Leiden, The Netherlands.

Van Dolah, Calder, and Knott 1984

Van Dolah, R. F., Calder, D. R., and Knott, D. M. 1984. "Effects of Dredging and Open Water Disposal on Benthic Macroinvertebrates in a South Carolina Estuary," *Estuaries*, Vol 7, pp 28-37.

Van Dolah et al. 1979

Van Dolah, R. F., Calder, D. R., Knott, D. M., and Maclin, M. S. 1979. "Effects of Dredging and Unconfined Disposal of Dredged Material on Macrobenthic Communities in Sewee Bay, South Carolina," Technical Report 39, South Carolina Marine Resources Center, Charleston, SC.



Van Wijck and Smits 1991

Van Wijck, J., and Smits, J. 1991. "Underwater Disposal of Dredged Material: A Viable Solution for the Maintenance of Dredging Works in the River Scheldt," Bulletin No. 73, Permanent International Association of Navigation Congresses.

Verna and Pointon 2000

Verna, T., and Pointon, M. 2000. "U.S. Army Corps of Engineers Dredging of Channels and Waterways," *Proceedings of the Western Dredging Association Twentieth Technical Conference and Thirty-Second Annual Texas A&M Dredging Seminar*, June 25-28, 2000, Warwick, RI, pp 213-227.

Viosca 1958

Viosca, P. 1958. "Effect of Dredging Operations," Louisiana Wildlife and Fisheries Commission Biennial Report (1956-1957).

Wakeman 1977

Wakeman, T. H. 1977. "Release of Trace Constituents from Sediments Resuspended During Dredging Operations," *Chemistry of Marine Sediments*, Ann Arbor Science, Ann Arbor, MI, pp 118-221.

Wakeman, Sustar, and Dickson 1975

Wakeman, T. H., Sustar, J. F., and Dickson, W. J. 1975. "Impacts of Three Dredge Types Compared in San Francisco District," *Proceedings of the World Dredging and Marine Construction Conference*, Vol I 1, American Society of Civil Engineers, pp 9-14.

Wallen 1951

Wallen, L. E. 1951. "The Direct Effect of Turbidity on Fishes," *Bulletin of the Oklahoma Agricultural College*, Biological Series 2, Vol 48, pp 1-27.

Walsh and Malkasian 1978

Walsh, M. R. and Malkasian, M. D. 1978. "Productive Land Use of Dredged Material Containment Areas: Planning and Implementation Considerations," Technical Report DS-78-20, U.S. Army Engineer Waterways Experiment Station, Vicksburg, MS. <http://el.erdc.usace.army.mil/elpubs/pdf/ds78-20/ds78-20a.pdf>

Walski and Schroeder 1978

Walski, T. M., and Schroeder, P. R. 1978. "Weir Design to Maintain Effluent Quality from Dredged Material Containment Areas," Technical Report D-78-18, U.S. Army Engineer Waterways Experiment Station, Vicksburg, MS. <http://el.erdc.usace.army.mil/elpubs/pdf/trd78-18.pdf>

EM 1110-2-5025

31 Jul 15

Walter, Valente, and Fredette 2002

Walter, P. J., Valente, R. M., and Fredette, T. J. 2002. "Evaluating Sub-channel Confined Aquatic Disposal Cells: Experience from the Boston Harbor Navigation Improvement Project." *Proceedings of the Third Specialty Conference on Dredging and Dredged Material Disposal - Dredging '02 - Key Technologies for Global Prosperity*, 5-8 May 2002, Orlando, FL. Stephen Garbaciak, Jr., ed., Published by the American Society of Civil Engineers.

Wang and Chen 1977

Wang, C. C., and Chen, K. Y. 1977. "Laboratory Study of Chemical Coagulation as a Means of Treatment for Dredged Material," Technical Report D-77-39, U.S. Army Engineer Waterways Experiment Station, Vicksburg, MS. <http://el.erdc.usace.army.mil/elpubs/pdf/trd77-39.pdf>

Watt 1965

Watt, J. P. C. 1965. "Development of the Dye-Dilution Method for Measuring Water Yields from Mountain Watersheds," M.S. Dissertation, Colorado State University, Fort Collins, CO.

Weber 1973

Weber, C. I., ed. 1973. "Biological Field and Laboratory Methods for Measuring the Quality of Surface Waters and Effluents," EPA-670/4-73-001, EPA Office of Research and Development, Cincinnati, OH.

Welp and Rosati 2000

Welp, T. L., and Rosati, J., III. 2000. "Initial Corps Experience with Tons Dry Solid (TDS) Measurement," *DOER Technical Notes Collection* ERDC TN-DOER-I2, U.S. Army Engineer Research and Development Center, Vicksburg, MS. <http://el.erdc.usace.army.mil/elpubs/pdf/doeri2.pdf>

Welp, Clausner, and Pilon 1998

Welp, T. L., Clausner, J. E., and Pilon, R. L. 1998. "Toussaint River Unexploded Ordnance (UXO) Demonstration Dredging Project," Miscellaneous Paper CHL-98-6, U.S. Army Engineer Waterways Experiment Station, Vicksburg, MS. <http://www.dtic.mil/cgi-bin/GetTRDoc?Location=U2&doc=GetTRDoc.pdf&AD=ADA353974>

Welp, Pilon, and Bocamozo 1998

Welp, T., Pilon, R., and Bocamozo, L. 1998. "Dredging in Unexploded-Ordnance (UXO)-contaminated Sediment," *Proceedings of the 15<sup>th</sup> World Congress*, Las Vegas, NV.

Welp et al. 1994

Welp, T., Clausner, J., Pope, J., Lewis, R., and Pilon, R. 1994. "Unexploded Ordnance (UXO) and Dredging," *Dredging '94, Proceedings of the Second international Conference on Dredging and Dredged Material Placement*, Lake Buena Vista, FL, November 13-16, 1994. E. C. McNair, ed., American Society of Civil Engineers, New York, pp 48-55.

Welp et al. 2001

Welp, T., Hayes, D., Tubman, M., McDowell, S., Fredette, T., Clausner, J., and Albro, C. 2001. "Dredge Bucket Comparison Demonstration at Boston Harbor," ERDC/CHL CHETN-VI-35, U.S. Army Engineer Research and Development Center, Vicksburg, MS. <http://chl.erdc.usace.army.mil/library/publications/chetn/pdf/chetn-vi-35.pdf>

Welp et al. 2008

Welp, T., Follett, F., Crull, M., and Pollock, C. 2008. "Dredging in Sediments Containing Munitions and Explosives of Concern (MEC)," ERDC/CHL TR-08-12, U.S. Army Engineer Research and Development Center, Vicksburg, MS. <http://el.erdc.usace.army.mil/elpubs/pdf/trchl08-12.pdf>

Westley et al. 1973

Westley, R. E., Finn, E., Carr, M. I., Tarr, M. A., Schotz, A. I., Goodwin, L., Stenberg, R. W., and Collias, E. E. 1973. "Evaluation of Effects of Channel Maintenance Dredging and Disposal on the Marine Environment in Southern Puget Sound, Washington," Washington Department of Fisheries, Olympia, WA.

Whiteside, Ng, and Lee 1996

Whiteside, P., Ng, K., and Lee, W. 1996. "Management of Contaminated Mud in Hong Kong." *Terra et Aqua*, Vol 65, pp 10-17.

Wilber 1971

Wilber, C. G. 1971. "Turbidity, Animals," *Marine Ecology*, Vol 1, John Wiley and Sons, London, pp 1181-1189.

Wilber 1993

Wilber, P. 1993. Managing Dredged Material Via Thin-Layer Disposal in Coastal Marshes. Technical Notes EEDP-01-32. Prepared by U.S. Army Engineer Waterways Experiment Station, Vicksburg, MS. [Technical Notes EEDP-01-32](#)

Wilber et al. 2005

Wilber, D. H., Brostoff, W., Clarke, D. G., and Ray, G. L. (2005). "Sedimentation: Potential biological effects from dredging operations in estuarine and marine environments," DOER Technical Notes Collection (ERDC TN-DOER-E20), U.S. Army Engineer Research and Development Center, Vicksburg, MS. <http://el.erdc.usace.army.mil/elpubs/pdf/doere20.pdf>

Williamson and Nelson 1985

Williamson, K. L., and Nelson, P. C. 1985. "Habitat Suitability Index Models and Instream Flow Suitability Curves: Gizzard Shad," Biological Report 82(10.112), Western Energy and Land Use Team, Division of Biological Services, Research and Development, Fish and Wildlife Service, U.S. Department of the Interior, Washington, DC.

EM 1110-2-5025

31 Jul 15

Willoughby 1977

Willoughby, W. E. 1977. "Low-Ground-Pressure Construction Equipment for Use in Dredged Material Containment Area Operation and Maintenance: Performance Predictions," Technical Report D-77-7, U.S. Army Engineer Waterways Experiment Station, Vicksburg, MS.

Wilson 1950

Wilson, W. B. 1950. "The Effects of Sedimentation Due to Dredging Operations on Oysters in Copano Bay, Texas," M.S. thesis, Texas A&M, College Station, TX.

Wilson 1968

Wilson, J. F. 1968. "Fluorometric Procedures for Dye Tracing," *Techniques of Water Resources Investigations of the U.S. Geological Survey*, Vol 3, U.S. Geological Survey, Washington, DC.

Windom 1972

Windom, H. L. 1972. "Environmental Aspects of Dredging in Estuaries," *Journal of Water, Harbor, and Coastal Engineering*, Vol 98, pp 475-487.

Windom 1976

Windom, H. L. 1976. "Environmental Aspects of Dredging in the Coastal Zone," *CRC Critical Review in Environmental Control*, No. 6, pp 91-110.

Winfield and Lee 1999

Winfield, L. E., and Lee, C. R. 1999. "Dredged Material Characterization Tests for Beneficial Use Suitability," *DOER Technical Notes Collection (TN DOER-C2)*, U.S. Army Engineer Research and Development Center, Vicksburg, MS. <http://el.erd.c.usace.army.mil/elpubs/pdf/doerc2.pdf>

Winter 2002

Winter, T. C. 2002. "Subaqueous Capping and Natural Recovery: Understanding the Hydrogeologic Setting at Contaminated Sites," *DOER Technical Notes Collection (TN DOER-C26)*, U.S. Army Engineer Research and Development Center, Vicksburg, MS. <http://el.erd.c.usace.army.mil/elpubs/pdf/doerc26.pdf>

Wolf, Shanholtzer, and Reimold 1970

Wolf, P. L., Shanholtzer, S. F., and Reimold, R. J. 1970. "Population Estimates for *Uca pugnax* (Smith, 1970) on the Dublin Estuary Marsh, GA, U. S. A.," *Crustacean*, Vol. 29, No. 1, pp 79-91.

World Dredging Mining and Construction 2003

World Dredging Mining and Construction. 2003. "Worldwide Dredge Fleets, Suppliers & Engineers," *World Dredging Mining & Construction*, 39(3), pp 8-63.

Wright, Mathis, and Brannon 1978

Wright, T. D., Mathis, D. B., and Brannon, J. M. 1978. "Aquatic Disposal Field Investigations, Galveston, Texas, Offshore Disposal Site; Evaluative Summary," Technical Report D-77-20, U.S. Army Engineer Waterways Experiment Station, Vicksburg, MS.

Yagi, Koiwa, and Miyazaki 1977

Yagi, T., Koiwa, T., and Miyazaki, S. 1977. "Turbidity Caused by Dredging," *Proceedings of WODCON VII: Dredging, Environmental Effects and Technology*, Texas A&M University, College Station, TX. pp 1079-1109.

Yagi et al. 1975

Yagi, T., Miyazaki, S., Okyama, Y., Koreishi, A., Sata, Y., Saito, M., Nakazono, Y., Masuda, K., Kono, S., Shibuya, Y., Kikuchi, K., and Kikya, T. 1975. "Influence of Operating Conditions Against Dredging Capacity and Turbidity," Technical Note No. 228, Port and Harbor Research Institute, Ministry of Transport, Japan.

Yotsukura and Kilpatrick 1973

Yotsukura, N., and Kilpatrick, F. A. 1973. "Tracer Simulation of Soluble Waste Concentration," *Journal of the Environmental Engineering Division*, American Society of Civil Engineers, Vol 9, No. 8.

Zeller and Wastler 1986

Zeller, R. W., and Wastler, T. A. 1986. "Tiered Ocean Disposal Monitoring Will Minimize Data Requirements," *Oceans 86*, Vol. 3: Monitoring Strategies Symposium. Institute of Electrical and Electronics Engineers, New York, pp 1004-1009.

Zieman 1982

Zieman, J. C. 1982. "The Ecology of the Seagrass of South Florida: A Community Profile". National Coastal Ecosystems Team, Office of Biological Services, U.S. Department of the Interior, Washington, DC.

Zundel 2005

Zundel, A. K. 2005. "Surface-Water Modeling System Reference Manual, Version 9.0" Brigham Young University Environmental Modeling Research Laboratory, Provo, UT. [http://www.ems-i.com/SMS/SMS\\_Overview/sms\\_overview.html](http://www.ems-i.com/SMS/SMS_Overview/sms_overview.html)

EM 1110-2-5025  
31 Jul 15

THIS PAGE INTENTIONALLY LEFT BLANK

## APPENDIX B

### Dredging Environmental Considerations

B.1 Introduction. This appendix presents environmental considerations associated with the excavation and placement processes of the different types of dredges. Biological considerations of dredging include suspended sediments, sedimentation, chemical release, dissolved oxygen (DO) reduction, channel blockage, and entrainment. Equipment to control, or mitigate, impacts at the excavation (as opposed to placement) site are also described. The term “impact,” as used in the environmental realm, denotes detectable changes in physical, chemical, or biological components of an ecosystem. In its simplest form, an impact refers to a biological response to some physical or chemical alteration to preexisting conditions as the result of human activities or natural events. These effects may result from suspended sediments, turbidity, direct physical impact, changes in habitat, and, in certain situations, by contaminant levels.

#### B.2 Sediment Resuspension Caused by Different Dredges.

B.2.1 The nature, degree, and extent of dredged material dispersion around a dredging operation are controlled by many factors (Barnard 1978). These factors include the characteristics of the dredged material, such as its size distribution, solids concentration, and composition; the nature of the dredging operation, such as the dredge type and size, discharge cutter configuration, discharge rate, and operational procedures being used; and the characteristics of the hydrologic regime in the vicinity of the operation, including salinity and hydrodynamic forces (for example, waves and currents). The relative importance of these factors varies from site to site.

B.2.2 With a given set of environmental conditions, different types of dredges generate different levels of turbidity. In this appendix, the term “turbidity” is used when an optical measurement of water quality was made, and the term “total suspended sediments” (TSS) is used when a gravimetric measurement of water quality was made. Also, the term “sediment resuspension” is used to describe the mixing of sediment into the water column due to dredging activities. Though the type of dredging equipment has a major effect on the amount and concentration of sediment that is resuspended, the techniques for operating this equipment also assume importance. Studies carried out by Huston and Huston (1976) indicate that operator training and performance are important contributing factors controlling sediment resuspension. While Barnard (1978) indicates that it is difficult to evaluate the various parameters of the operation of a dredge that reflect the skills of the operator, Huston and Huston (1976) observed that there was a lack of formal training, research, and development for dredging. As a result, it has been found in most of the literature concerning this topic that turbidity levels were measured with little regard to the operation of the dredges or their production rates. With this in mind, Barnard (1978); Herbich and Brahme (1991); McLellan et al. (1989); and Hayes, Borrowman, and Welp (2000) examined the turbidity levels generated by different types of conventional dredges.

### B.3 Generation of Turbidity by Type of Dredge.

#### B.3.1 Hydraulic cutterhead dredging.

B.3.1.1 The cutterhead dredge, the most commonly used dredge in the United States, is very versatile. As described in Chapter 2, "Dredging and Navigation Project Management," this type of dredge uses a rotating cutter, located at the end of a ladder, that excavates the bottom sediment and guides it into the suction. For conventional cutterhead dredges, the diameter of the cutter is approximately three to four times the diameter of the suction pipe. Most of the sediment resuspended by a cutterhead dredging operation (exclusive of placement) is usually found in the vicinity of the cutter (Barnard 1978). The levels of sediment are directly related to the type and quantity of material cut but not picked up by the suction. The amount of material supplied to the suction is controlled primarily by the rate of cutter rotation, the vertical thickness of the dredge cut, and the horizontal velocity of the cutter moving across the cut. In addition to the dredging equipment used and its mode of operation, sediment resuspension can also be caused by sloughing of material from the sides of vertical cuts and inefficient operational techniques.

B.3.1.2 Field data are available for sediment in suspension in the vicinity of cutterhead dredges at various places. The limited data collected under low-current conditions show that elevated levels of suspended material appear to be localized to the immediate vicinity of the cutter as the dredge swings back and forth across the dredging site (Barnard 1978). Within 3 m (10 ft) of the cutter, suspended solids concentrations are highly variable, but they may be as high as tens of grams per liter (g/L); these concentrations decrease exponentially from the cutter to the water surface. Near-bottom suspended solids concentration was found to be on the order of a few hundred milligrams per liter (mg/L) at distances of a few hundred meters from the cutter. Yagi et al. (1975) concluded from these observations that "in the case of a steady dredging of a thin sedimented mud layer, the effect of dredging on turbidity was almost found to be imperceptible at locations several tens of meters distance from the cutter."

B.3.1.3 A properly designed cutter efficiently cuts and guides the bottom material toward the suction, but the cutting action and the turbulence associated with the rotation of the cutter resuspends a portion of the bottom material being dredged. Excessive cutter rotation rates tend to propel the excavated material away from the suction pipe inlet. Huston and Huston (1976) conducted measurements of turbidity created by a cutterhead dredge in the Corpus Christi Ship Channel. The top 1.5 to 2 m (5-6.5 ft) of material was sandy clay while the underlying layer of about 6 m (20 ft) depth consisted of medium clay. The various samples collected in this channel, described by Bartos (1977), showed that the sediment consisted of inorganic clays of high plasticity (CH) with the percent passing the No. 200 sieve varying from 76 to 98. Table B-1 indicates the turbidity readings at three different cutter speeds. This table shows that the near-bottom suspended solids level within 2 m (6.5 ft) of the cutter of a 69 cm (27 in.) cutterhead dredge widening a portion of the Corpus Christi Ship Channel ranged from background concentrations to 580 mg/L relative to the "background" levels of 39-209 mg/L measured 73 m (240 ft) to the side of the dredge (Huston and Huston 1976). Similar data around a 61 cm (24 in.) cutterhead dredge excavated fine-grained maintenance material (96-98% passing No. 200 sieve-highly plastic inorganic clay [Bartos 1977]) from the Mobile Bay Ship Channel showed near-bottom TSS levels of up to 125 mg/L as opposed to background levels of 25-30 mg/L, which occurred approximately 300 m (985 ft) in front of the cutterhead (Barnard 1978). The increase in



the TSS was found only within 1.5 m (5 ft) of the bottom. Field data are also available from Yokkaichi Harbor, Japan (Barnard 1978). Levels of suspended solids under low-current conditions near the cutter of a 61 cm (24 in.) cutterhead dredge excavating fine-grained material in this harbor ranged from 2 mg/L to 31 g/L at a distance of 1 m (3.3 ft) above the cutter relative to the background levels of 1-18 mg/L. Average TSS levels appeared to decrease exponentially from the cutter to the water surface. At a distance of 60 m (200 ft) in front of the cutter, TSS levels in the near-surface water ranged from 1 to 17 mg/L whereas near-bottom levels ranged from 5 to 205 mg/L (Yagi et al. 1975).

Table B-1. Turbidity and Suspended Solids Concentrations at Different Cutter Speeds Using a 69 cm (27 in.) Dredge (Huston and Huston 1976)

Depth of Sample m/ft	10 rpm			20 rpm			30 rpm		
	%T	mg/L	NTU	%T	mg/L	NTU	%T	mg/L	NTU
Cut No. 1, 6.1 m/20 ft									
0.9/3	55	26	8	70	22	6	72	154	4
2.7/8.9	65	89	10	65	12	6	68	91	4
5.4/17.7	42	161	43	5	187	44	24	580	45
Cut No. 2, 9.1 m/30 ft									
0.9/3	47	114	3	56	--	7	66	106	4
3.0/10	41	64	9	45	46	7	65	80	5
6.1/20	44	102	15	38	--	8	50	11	15
9.1/30	17	55	14	5	37	37	4	208	26
Cut No. 3, 12.2 m/40 ft									
0.9/3	54	144	3	55	75	5	66	125	4
3.0/10	48	150	10	58	--	6	66	72	8
6.1/20	52	25	7	60	165	10	63	56	9
9.1/30	30	--	5	47	94	8	26	138	22
12.2/40	7	52	12	24	176	30	2	266	57

Note: %T = percent transmission

B.3.1.4 The various studies show that operational conditions exert considerable influence on sediment resuspension in the vicinity of a cutterhead dredge. As indicated earlier, the levels of turbidity found near the cutter depend primarily on the type and amount of material that is excavated but not drawn into the dredge suction. This “residual” material may remain in suspension or may settle into the existing cut, where it again becomes susceptible to resuspension by ambient currents and turbulence generated during subsequent cuts. Analysis of the data collected at Yokkaichi Harbor, Japan, indicates that as the amount of this residual material increases, the turbidity levels around the cutter apparently increase exponentially. According to calculations made by Yagi, as explained by Barnard (1978), the amount of residual material increases as the swing rate increases. Barnard examined the data further and found that in most cases the amount of residual material generally increases as the thickness of the cut increases. Consequently, as the thickness of the cut and the swing rate increase, the turbidity levels generated by the operation

increase exponentially (Barnard 1978). A similar relationship exists between sediment resuspension and rate of cutter rotation (Huston and Huston 1976).

B.3.1.5 As stated in the previous paragraph, the amount of material remaining in suspension from the previous cuts also controls the level of turbidity in the vicinity of the cutter. Yagi et al. (1975) found that during the first four swings of dredging operation monitored, the levels of turbidity around the cutter increased with each successive cut. This was found to continue until a quasi-steady-state condition was reached. Barnard (1978) further analyzed the data in detail and found a relationship between the levels of turbidity around a cutterhead and the dredge production rate. The relationship for fine-grained material is shown in Figure B-1. There is some scatter in the data, but a general trend can easily be seen. The data within the shaded portion in the figure indicate that it is possible to increase the rate of dredge production up to a maximum rate without generating excessive levels of turbidity. (The shaded area shows more than 75% of the data points). Kuo, Welch, and Lukens (1985) developed a model to describe the turbidity plume induced by dredging a ship channel using a cutterhead hydraulic dredge. The model predicts the suspended sediment concentration within the plume and the resulting sediment deposition alongside the dredged channel. Additional numerical models are described in Chapter 2, "Dredging and Navigation Project Management."

B.3.1.6 Huston and Huston (1976) collected large amounts of information on cutterhead-dredge-induced turbidity and also carried out field studies at Corpus Christi Ship Channel. Based on the analysis of the turbidity data, they concluded that the turbidity data show the following trends:

a. In most cases, the transmission and scattering of data show an increase in turbidity above background levels only in the immediate vicinity of the cutter. The increased levels of turbidity around the cutter are probably due to suspension of fine-grained material created by the turbulence generated by the cutter.

b. Apparently little of the turbidity created by the cutter goes into the upper water column, especially from depths of 9-12 m (30-40 ft). This is also supported by the fact that no substantial visible surface turbidity is ever observed.

c. Although the turbidity data collected in the immediate vicinity of the cutter are quite variable, probably due to cutter-generated turbulence, there also may be a general, but inconsistent, increase in turbidity with increasing revolutions per minute (rpm). This inconsistency may be due to cutter-generated turbulence, variability in the material being dredged, or suction velocity.

B.3.1.7 Grimwood (1983) collected sediment resuspension data during cutterhead maintenance dredging off the Louisiana coast in an effort to assay potential environmental damage during both dredging and placement operations. It was generally concluded that the material dredged during these investigations did not present a hazardous waste disposal problem, as dilution was rapid and increased concentrations of pollutants were confined to the placement area or mixing zone.

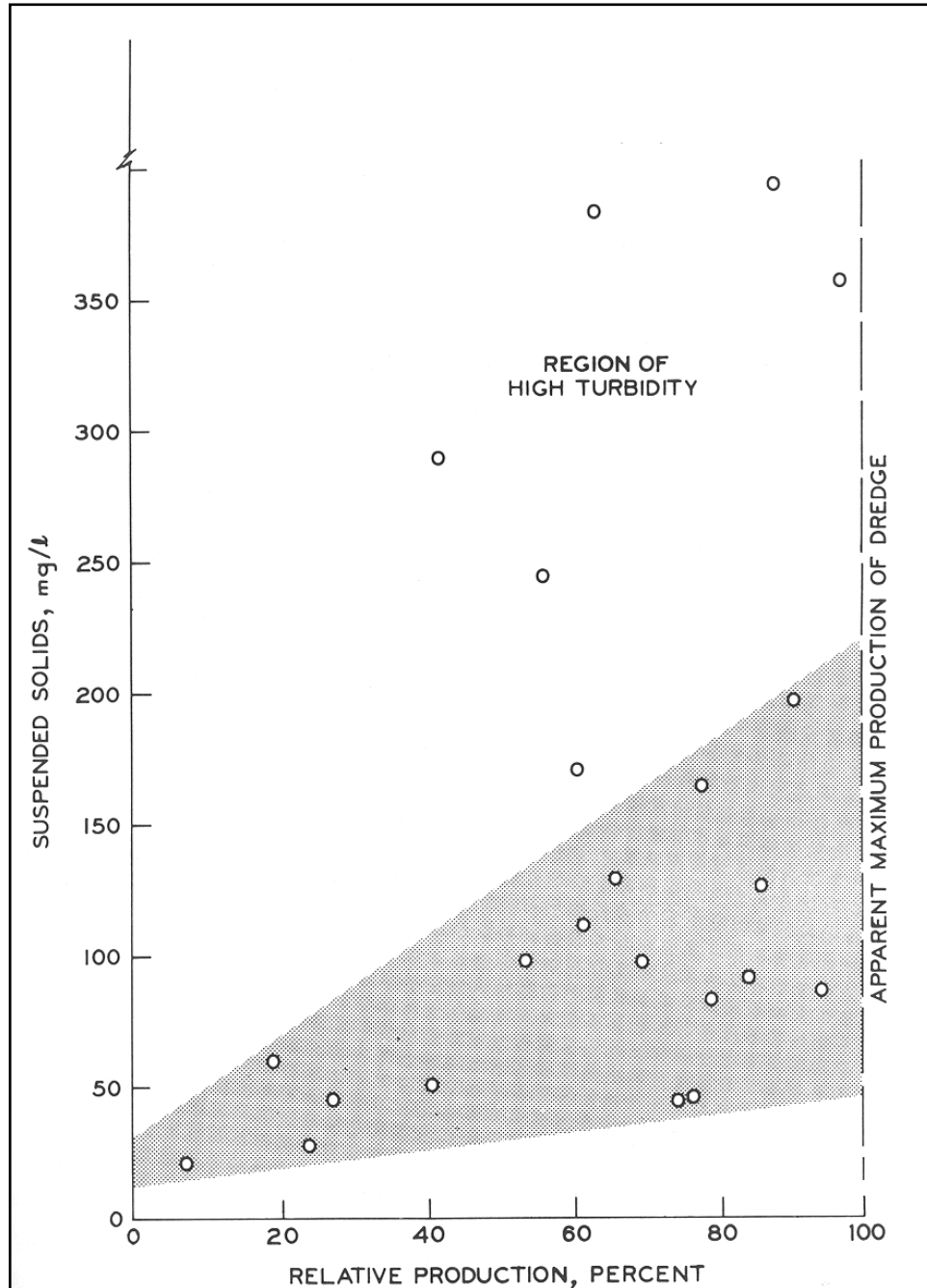

Figure B-1. Relationship Between the Levels of Turbidity Around a Cutterhead and the Dredge Production Rate (from Barnard 1978)

B.3.1.8 Measurements of suspended sediment fields around cutterhead dredge operations summarized in Table B-2 and in additional studies (Markey and Putnam 1976; Smith et al. 1976; Sustar, Wakeman, and Ecker 1976; Koba and Shiba 1983; Kuo, Welch, and Lukens 1985) demonstrate that elevated levels of suspended sediments appear to be restricted to the immediate vicinity of the cutterhead with little suspension in surface waters. Maximum levels of suspended sediment, on the order of tens of g/L, are confined to within 3 m (10 ft) above the cutterhead and

decline exponentially to the water surface. Near-bottom levels may be on the order of hundreds of mg/L at distances of up to a few hundred meters laterally from the cutterhead. Upper-water column levels are usually quite low or even undetectable, depending on water depth.

Table B-2. Spatial and Temporal Characteristics of Suspended Sediment Fields During Hydraulic Cutterhead Dredging Operations

Location	Suspended Sediment Field Characteristics	Reference
Mobile Bay, AL	Suspended sediment concentrations around a 61 cm (24 in.) cutterhead dredge were elevated above background levels only within 1.5 m (5 ft) of the bottom. Near-bottom concentrations of up to 125 mg/L occurred approximately 300 m (1000 ft) in front of the cutterhead. Silts and clay.	Barnard (1978)
Corpus Christi Ship Channel, TX	Near-bottom suspended sediment concentrations within 2 m (6.5 ft) of the cutterhead of a 69 cm (27 in.) cutterhead dredge ranged from background levels to 580 mg/L measured 73 m (29 in.) to the side of the dredge. Fine-grained.	Huston and Huston (1976)
Yokkaichi Harbor, Japan	Concentrations of suspended sediment under low-current conditions near the cutterhead of a 61 cm (24 in.) cutterhead dredge ranged from 2 mg/L to 31 g/L, 1 mg/L to 16 g/L, and 1 mg/L to 4 g/L at distances of 1, 2, and 3 m (3.3, 6.5, and 9.8 ft) above the cutterhead, respectively, relative to background levels. Average concentrations decreased exponentially to the water surface. Fine-grained.	Yagi et al. (1975)
James River, VA	Average suspended sediment concentrations over a 4-day period within 800 ft (200 m) of a 46 cm (18 in.) cutterhead dredge ranged from background levels to 282 mg/L above background. Levels greater than 200 mg/L above background were restricted to the lower water column while average values for flood and ebb tide for the upper water column were 11.5 mg/L and 37.5 mg/L, respectively. Clay.	Raymond (1984)
Savannah River, GA	Suspended sediment concentrations within 480 m (1,600 ft) of a cutterhead dredge were generally less than 200 mg/L in the lower water column and less than 200 mg/L and 50 mg/L in the middle and upper water column, respectively. Silts.	Hayes (1986)
Imari and Osaka Bays, Japan	Suspended sediment concentration, above background, measured around three dredges. Mean values of suspended sediment levels for upper and lower water column ranged from 2-5 mg/L at 50 m (165 ft), 2-3 mg/L at 100 m (330 ft), and 2 mg/L at 200 m (660 ft). Maximum levels never exceeded 72 mg/L above background. Clay.	Koba (1984)

Suspended sediment levels generated by the cutterhead apparently increase exponentially as the thickness of the cut, rate of swing, and cutterhead rotation increase. Current speeds above 0.6 m/sec (2 ft/sec) associated with ebb and flood tidal action can, however, significantly affect the suspended sediment field by propelling materials higher into the water column. High-velocity ebb tides have the greatest effect.

### B.3.2 Trailing suction hopper dredge.

B.3.2.1 The operational characteristics of a hopper dredge are described in Chapter 2, "Dredging and Navigation Program Management." Resuspension of the fine-grained, maintenance-dredged material during hopper dredge operations is caused by the dragheads as they are pulled through the sediment, by turbulence generated by the vessel and its propeller wash, by overflow of turbid water during hopper filling operations, and by dispersion of dredged material during open-water disposal. Overflow water is the most obvious source of near-surface turbidity. Distributions of suspended solids in these overflow plumes are dependent on many factors, such as nature of the sediment being dredged; the design and operation of the dredge; and the nature, concentration, and volume of the overflowed material.

B.3.2.2 Field measurements of suspended solids concentrations in the vicinity of the hopper dredge *Chester Harding* during a maintenance dredging operation at San Francisco Bay are available (Barnard 1978). These measurements indicate that a near-bottom turbidity plume of suspended dredged material extended up to 700 m (2,300 ft) downcurrent from the dredge. In the immediate vicinity of the dredge, a well-defined upper plume was generated by the overflow process, and a near-bottom plume was generated by draghead resuspension; 300-400 m (1,000-1,300 ft) behind the dredge, the two plumes merged into a single plume. With the increase in the distance from the dredge, the suspended solids concentrations in the plume generally decreased, and the plume became increasingly limited to the near-bottom waters. According to the studies conducted by Bartos (1977), the type of seabed material in the San Francisco Bay is inorganic clay of high plasticity with 58% passing the No. 200 sieve. Suspended solids concentrations in the upper and middepth water column were rarely found to exceed several hundred mg/L in relation to the background concentration of 31-35 mg/L.

B.3.2.3 Near-surface measurements for suspended solids concentrations were also made in the overflow plumes generated by hopper dredge *Markham* in Saginaw Bay Ship Channel, Lake Huron, and by hopper dredge *Goethals* in the Thimble Shoal Channel, Chesapeake Bay (Barnard 1978). These measurements are summarized in Figure B-2. It can be seen that the suspended solids concentrations were as high as 200 g/L in the overflow plume of the dredge *Markham*. The solids concentrations dropped to 800 mg/L at a distance of 1,200 m (4,000 ft) from the dredge overflow ports. A similar trend is seen for the dredge *Goethals* in Chesapeake Bay. The corresponding values for suspended solids concentrations were 2 g/L and 200 mg/L, respectively. These measurements indicate that the suspended solids levels generated by a hopper dredge are caused primarily by overflow in the near-surface water and draghead resuspension in the near-bottom water. Suspended solids concentrations may be as high as several tens of g/L near the discharge port and as high as a few g/L near the draghead. It was found that plume concentrations exceeded the background levels even at distances in excess of 1,200 m (4,000 ft).

31 Jul 15

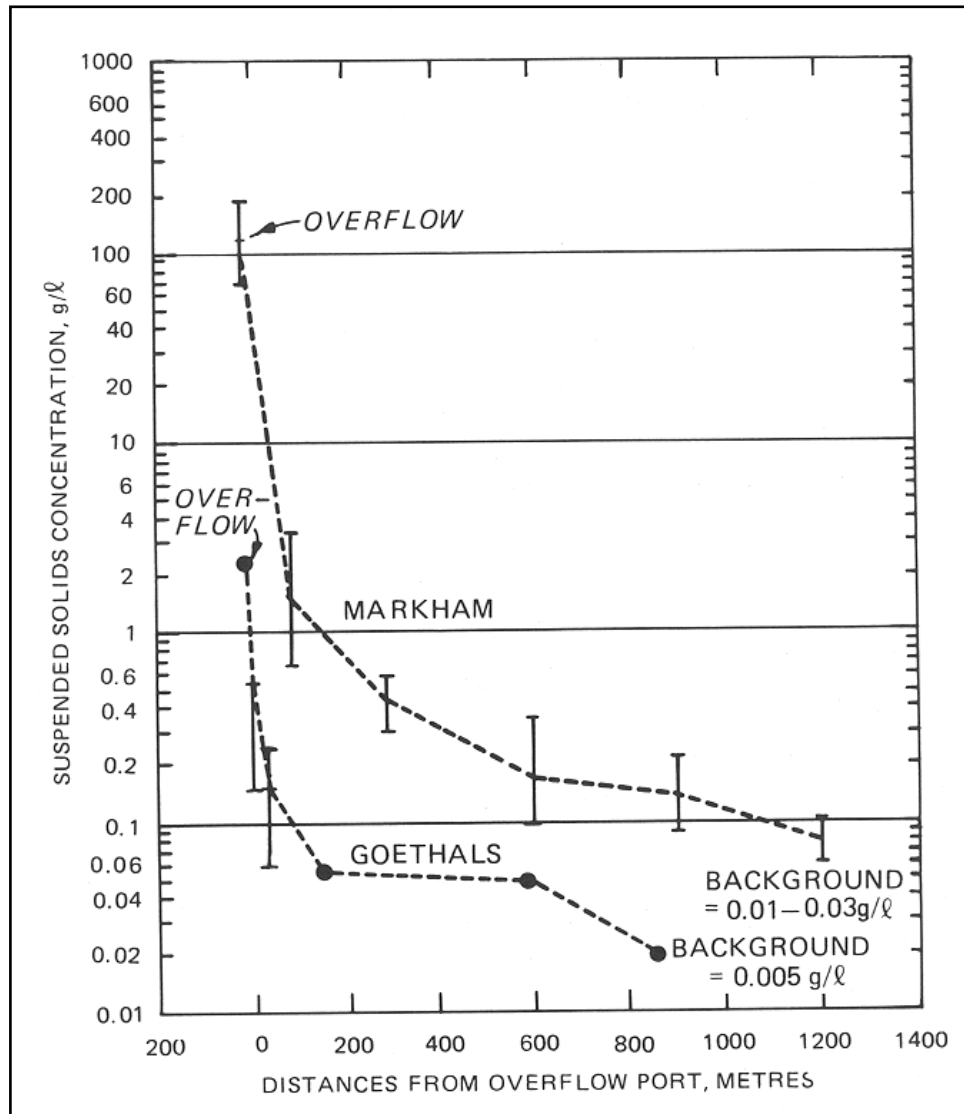

Figure B-2. Near-Surface Measurements for Suspended Solids Concentrations of Various Hopper Dredges

B.3.2.4 A comparison of hopper dredge operations with and without overflow (Hayes, Raymond, and McLellan 1984) indicated that, in the absence of overflow, a turbidity plume was not encountered in the surface or middepth levels and that the maximum suspended sediment level in the near-bottom plume was 70 mg/L.

B.3.2.5 Measurements of suspended sediment fields around hopper dredge operations are summarized in Table B-3. Suspended sediment levels may be on the order of tens of g/L near the hopper overflow and on the order of a few g/L or less near the draghead. Suspended sediment levels in the near-surface plume decrease exponentially with distance from the dredge. However, a plume may occasionally be perceptible at distances in excess of 1,200 m (4,000 ft), largely because this type of dredge is in constant motion.

Table B-3. Spatial and Temporal Characteristics of Suspended Sediment Fields  
During Hopper Dredging Operations

Location	Suspended Sediment Field Characteristics	Reference
San Francisco Bay, CA	Suspended sediment concentrations in the near-bottom plume were usually less than a few grams per liter while the upper near-surface plume concentrations ranged from several hundred milligrams per liter away from the dredge to several grams per liter adjacent to the dredge overflow. Both plumes extended 700 m (2,300 ft) or more downcurrent. Silty clay.	U.S. Army Engineer District, San Francisco (1976)
Saginaw Bay, Lake Huron, MI	Near-surface suspended sediment concentrations ranged from 100 g/L at the dredge to near 80 mg/L 1,200 m (4,000 ft) downstream. Overflow concentrations decreased exponentially with distance from the dredge.	Pollack (1968)
Thimble Shoal, Chesapeake Bay	Near-surface suspended sediment concentrations ranged from 100 g/L at the dredge overflow to near 20 mg/L 850 m (2,800 ft) downstream. Concentrations decreased exponentially with distance from the dredge.	JBF Scientific Corp. (1974)
Grays Harbor, WA	In the absence of hopper overflow, the suspended sediment plume was restricted to the near-bottom waters and appeared to be 60 m wide (200 ft) and 1,100 m (3,600 ft) long with maximum concentrations of 70 mg/L. In the presence of hopper overflow the surface plume appeared to be 60 m (200 ft) wide and 1,200 m (4,000 ft) long with concentrations reaching 857 mg/L at 30 m (100 ft) behind the dredge. The near-bottom plume appeared to be greater than 120 m (400 ft) wide and 2,600 m (8,500 ft) long with concentrations as high as 891 mg/L and 460 mg/L at 30 m (100 ft) and 60 m (200 ft) behind the dredge, respectively. Silty clay.	Hayes, Raymond, and McLellan (1984)

### B.3.3 Bucket (or clamshell) dredging.

B.3.3.1 The operational characteristics of clamshell and bucket dredges are described in Chapter 2, "Dredging and Navigation Program Management." Turbidity generated by a bucket dredge operation comes from four major sources: sediment suspension occurring upon bucket impact and withdrawal from the bottom, loss of material from the top and sides of a bucket as it is pulled up through the water column, spillage of turbid water out of the bucket when it breaks the water surface, and inadvertent spillage of material during barge loading or intentional overflow operations intended to increase barge effective load. A number of variables can affect the quantity of material suspended by the dredge, such as sediment type, bucket size and type (open or enclosed), volume of sediment dredged, hoisting speed, and hydrodynamic conditions at the dredging site.

31 Jul 15

B.3.3.2 Measurements of suspended sediment fields around bucket dredging operations summarized in Table B-4 and in additional studies by Sustar, Wakeman, and Ecker (1976) and Nakai (1978) suggest a general pattern for the spatial extent of sediment suspension. A typical operation can produce a downstream turbidity plume that extends 300 m (1,000 ft) at the surface and 500 m (1,600 ft) near the bottom (depth dependent). Maximum suspended sediment concentrations in the surface plume are generally less than 500 mg/L above ambient in the immediate vicinity of the operation and decrease rapidly with distance due to settling and dilution of the material. Average surface water column concentrations are generally less than 100 mg/L, while near-bottom concentrations are usually higher. The visible surface plume usually dissipates within an hour or two after the operation ceases, depending upon the type of material being dredged.

Table B-4. Spatial and Temporal Characteristics of Suspended Sediment Fields During Bucket Dredging Operations

Location	Suspended Sediment Field Characteristics	Reference
San Francisco Bay, CA	Nearfield concentrations of total suspended sediments were 21-282 mg/L.	Williamson and Nelson (1985)
San Francisco Bay, CA	Suspended sediment concentrations in the water column 50 m (165 ft) downstream from the dredge were generally less than 200 mg/L and averaged 30-90 mg/L relative to background concentrations outside the plume of approximately 40 mg/L. The visible plume was about 300 m (1000 ft) long at the surface and approximately 450 m (1,500 ft) long at a bottom depth of 10 m (33 ft).	U.S. Army Engineer District San Francisco (1976)
Lower Thames River Estuary, CT	Maximum suspended sediment concentrations of 68, 110, and 168 mg/L at the surface, mid depth (3 m [10 ft]), and near bottom (10 m [33 ft]), respectively, were noted within 100 m (330 ft) downstream. These maximum concentrations decreased very rapidly to the background levels of 5 mg/L within 300 m (1,000 ft) at the surface and 500 m (1,650 ft) near the bottom. Fine-grain sands and silts.	Bohlen and Tramontano (1977)
Lower Thames River Estuary, CT	Suspended sediment concentrations adjacent to the dredge were 200-400 mg/L and approached background within approximately 700 m (2,300 ft). Major perturbations were confined within 300 m (1,000 ft) of the dredge. Fine-grain sands and silts.	Bohlen, Cundy, and Tramontano (1979)
New Haven Harbor, CT	Suspended sediment plume (defined by transmissometer readings) was a well-defined small-scale feature extending over a distance of approximately 1,000 m (3,300 ft) downstream.	Gordon (1973)
Patapsco River, MD	Suspended sediment concentrations 22 m (72 ft) downstream from the dredging operation were 30 mg/L at near-bottom depths of 10 m (33 ft) relative to background water column concentrations of approximately 10 mg/L or less.	Cronin et al. (1976)

(continued)



Location	Suspended Sediment Field Characteristics	Reference
Japan	Maximum suspended sediment concentrations 7 m (23 ft) downstream from the dredging operation ranged from 150 to 300 mg/L (defined using turbidity measurements) relative to background levels of less than 30 mg/L. These levels decreased by 50% at a distance of 23 m (75 ft). Turbidity near the surface was generally lower than levels at middepth or near the bottom. Fine-grained.	Yagi, Koiwa, and Miyazaki (1977)
St. Johns River, FL	Sediment resuspension caused by bucket dredges showed that the plume downstream of a typical bucket operation may extend approximately 300 m (1,000 ft) at the surface and 450 m (1,500 ft) near the bottom. The average suspended sediment concentrations of all samples collected within 240 m (800 ft) of the dredge along upper water column and near-bottom transects were approximately 106 and 134 mg/L, respectively. Silts.	Raymond (1983)
St. Johns River, FL	A comparison of suspended sediment concentrations from open and enclosed bucket dredge operations showed considerable reductions in suspended sediment concentrations in the upper water column (>50%) but increases in concentrations in the lower water column (>50%) due to "shock" waves created by the closed bucket. Silts.	Hayes, Raymond, and McLellan (1984)
Thames River Estuary, CT	The composition of material suspended by the dredge indicates that variations are similar to those produced by local storm events. Storm events affect a significantly larger area and display a higher frequency of occurrence than that characterizing typical dredging schedules. Both storm events and dredges increase particulate organic carbon concentrations and bias the material composition in favor of the inorganic fractions. Sands and silts.	Bohlen, Cundy, and Tramontano (1979)
Patuxent River, MD	Total suspended sediment concentrations measured before, during and after dredging. Downstream stations showed increases of 42 mg/L (1,200 m [4,000 ft]) and 25 mg/L (600 m[2,000 ft]); upstream stations, 2 mg/L (1,000 ft) and 12 mg/L (2,000 ft). Postdredging concentrations returned to predredging levels of 34.44 mg/L within 19 days. Clayey-silt.	Onuschuk (1982)

B.3.3.3 Comparisons of open and watertight (or enclosed) bucket types indicate that surface-water suspended sediment concentrations may be reduced by 30-70% by using an enclosed bucket (Barnard 1978; Hayes, Raymond, and McLellan 1984). Near-bottom concentrations, however, were shown to increase by as much as 50-70% due to the effect of the enclosed bucket as it descends through the water. A shock wave of water precedes the bucket and serves to suspend loosened material prior to impact.

B.3.3.4 Bohlen, Cundy, and Tramontano (1979) describe bucket dredge-induced suspension as primarily a near-field phenomenon representing a relatively small-scale perturbation within an estuary. Sediment suspended by a dredge is likened to a small-scale storm that begins very suddenly, increases the concentrations and modifies the quality of suspended sediment fields compared with undisturbed conditions, and then produces a turbidity plume that decays very

31 Jul 15

rapidly following the reduction of energy required to suspend and maintain sediments in suspension.

B.3.3.5 Welp et al. (2001) investigated sediment resuspension and loading characteristics of a conventional (open-faced) clamshell bucket, an enclosed clamshell bucket, and a cable arm clamshell bucket under similar operating and environmental conditions in Boston Harbor during August 1999. Monitoring was conducted to characterize near and far-field sediment resuspension characteristics of each bucket.

B.3.3.6 Turbidity observations were the primary near-field data collected during the study. However, a limited number of discrete water samples were taken coincident with turbidity readings. Thirty-three samples were collected and analyzed for total suspended solids to corroborate the turbidity data during the bucket operations. Turbidity can be used as a surrogate for TSS, but it must be recognized that factors other than sediment concentration influence turbidity. These factors—which include particle size, shape, and organic content—complicate conversion of turbidity measurements to TSS concentration. Although the data correlating turbidity and TSS values in this study were scattered, they show a definite relationship:  $r^2 = 0.65$ . Over 226,000 turbidity observations were collected during three partial days studying the three buckets. The primary advantage of using turbidity is the rapid number of measurements that can be obtained at very little additional cost per sample measurement. Additionally, the observations can be monitored in real time to gather direct knowledge about the dredging operation itself. Turbidity data collected during extended downtimes were assumed to represent background conditions and used to adjust turbidity data. Measured ambient turbidity conditions are summarized in Table B-5. The results show turbidity conditions with relatively small ranges and standard deviations. These data seem to reasonably represent ambient turbidity conditions. Thus, average values were subtracted from all other turbidity observations to adjust them for ambient conditions.

Table B-5. Summary of (Near-Field) Background Turbidity Statistics, FTU

Depth m/ft	Average	Standard Deviation	Minimum	Maximum
1.5/4.9	3.9	0.34	3.0	7.4
5.5/18.0	3.3	0.56	2.2	11.7
8.0/26.2	4.0	1.0	2.7	9.0
10.5/34.4	21.4	3.8	13.3	31.0

B.3.3.7 The turbidity measurements (adjusted for ambient turbidity conditions) of the cable arm, enclosed, and conventional buckets are presented in Figures B-3, B-4, and B-5, respectively. The vertical line inside the box represents the median turbidity while the shaded box represents upper and lower quartiles on either side of the mean. The whiskers extend over the range of observed data.

B.3.3.8 The conventional bucket generated the highest turbidity and suspended sediment, probably because of erosion of sediments from the open top. The depth-averaged turbidity for the conventional bucket was 57.2 formazin turbidity units (FTUs), and suspended solids concentration was 210 mg/L (not adjusted for ambient TSS). Consistent with a prior study (McLellan et al. 1989), the conventional bucket distributed turbidity throughout the water

column. The TSS ranged from 105 mg/L in the middle of the water column to 445 mg/L near the bottom. Average turbidity varied a bit less and ranged from 46 to 64 FTU.

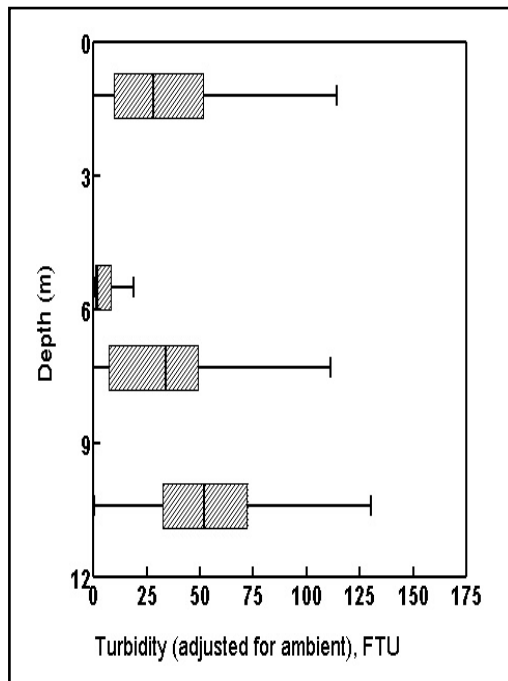

Figure B-3. Turbidity Measurement of a Cable Arm Bucket

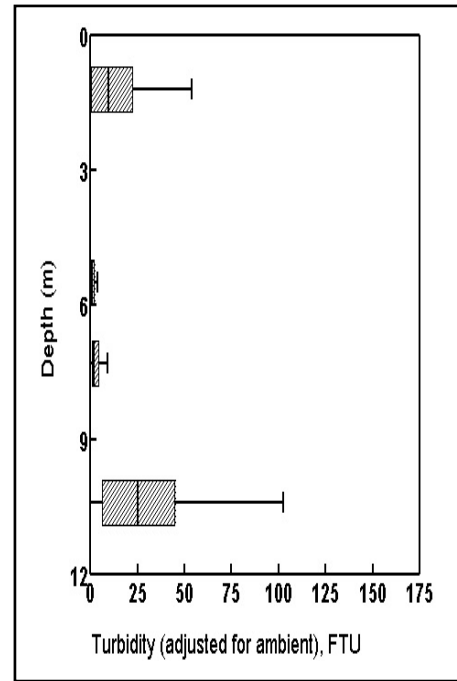

Figure B-4. Turbidity Measurement of an Enclosed Bucket

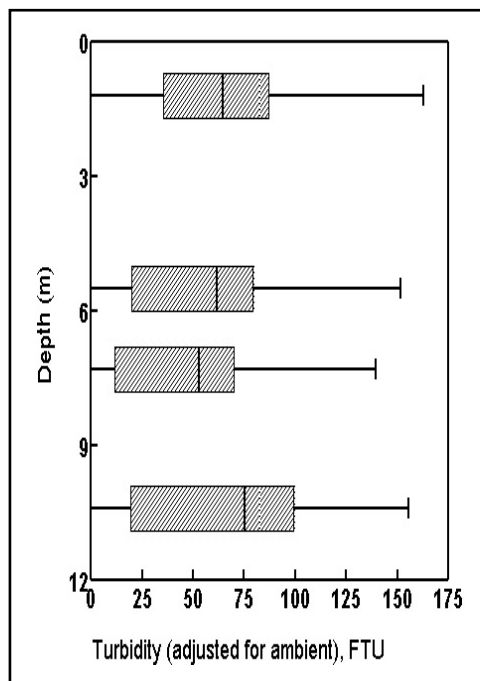

Figure B-5. Turbidity Measurement of a Conventional Bucket

B.3.3.9 Although both the cable arm and enclosed buckets leaked substantially through the seals and grated vents in the upper part of the buckets, neither resulted in as much turbidity or TSS as did the conventional bucket. The depth-averaged turbidities for the cable arm and enclosed buckets were 31 FTU and 12 FTU, respectively, and their depth-averaged TSS values were, respectively, 31 mg/L and 50 mg/L (compared with 210 mg/L for the conventional bucket). Six water samples were collected for TSS analysis for the cable arm bucket. However, uncharacteristically only four samples were used to calculate the TSS depth-averaged value because two of these samples were taken at a time when excessive debris was being encountered, keeping the bucket from closing properly and, thus, leading to high TSS values (200+ mg/L).

B.3.3.10 The most significant difference was in the middle water column, where turbidity values were substantially less than at the bottom and near the surface. Turbidity for the cable arm bucket ranged from 6 to 55 FTU, and TSS from 14 mg/L to 66 mg/L. The enclosed bucket resulted in turbidity from 1 to 31 FTU and TSS from 14 to 112 mg/L.

#### B.3.4 Barge and hopper overflow.

B.3.4.1 The process of overflow usually involves the intentional loading of sediment-laden water beyond the capacity of the barge or hopper in an effort to increase the effective solids content within the vessel. The basic assumption behind the practice is that, given time, heavier sediment particles will settle out within the barge or hopper, and relatively low-solids water can be displaced by additional material. In the case of barges, the material simply flows over the gunnel. In hopper dredges, multiple inflow pipes and hopper compartments and baffles act to reduce the flow rate of water and sediments after they enter the vessel, thereby enhancing settling. Overflow from hopper dredges comes from a point farthest from the inflow after most of the heavier sediment particles have settled out.

B.3.4.2 Measurements of suspended sediment fields around hopper dredge overflow operations have been reported by Barnard (1978); Hayes, Raymond, and McLellan (1984); Hayes (1986); Havis (1988a); McLellan et al. (1989); and Palermo and Randall (1990). Similar data are available on barge overflow activities associated with cutterhead (Clarke et al. 1990) and bucket dredge operations (Payonk, Palermo, and Teeter 1988; Palermo, Teeter, and Homziak 1990).

B.3.4.3 Overflow events can increase suspended sediment levels throughout the water column. Hopper dredge operations with overflow, as previously mentioned for Grays Harbor, WA (Hayes, Raymond, and McLellan 1984), can increase levels by 200 mg/L at the surface and 1,000 mg/L near the bottom. Turbidity plumes can extend from the dredge by as much as a few hundred meters at the surface and a few thousand meters along the bottom. Overflow tests (fine silts and clays) associated with a cutterhead operation in Mobile Bay, AL (Clarke et al. 1990), showed maximum levels of 60 mg/L for the surface and 6,000 mg/L along the bottom, with most levels falling below these. A study of overflow associated with a bucket dredge operation (silts and clays) in the Cape Fear River, NC (Payonk, Palermo, and Teeter 1988), reported maximum levels of suspended sediment (above background) of 87 mg/L for surface and 162 mg/L along the bottom at a distance of 100 m (330 ft) downstream. Another evaluation of clamshell dredging and barge overflow in Sunny Point, NC, (Palermo, Teeter, and Homziak 1990) concluded that the average suspended solids concentration of samples in the plume generated by dredging was

47 mg/L above background while that for the plumes generated by dredging with overflow was 65 mg/L above background.

B.3.4.4 Overall, overflow events can increase suspended sediment concentrations by as much as 100 mg/L at the surface and 1,000 mg/L along the bottom, with suspended sediment plumes extending a few hundred meters downstream for cutterhead and bucket dredges (stationary operations) and a few thousand meters for hopper dredges (mobile operations).

B.3.5 Dustpan dredge. The operational characteristics of a dustpan dredge are described in Chapter 2, "Dredging and Navigation Project Management." The suspended solids concentration in the vicinity of a dustpan dredge depends on the type of soil being dredged. In the case of free-flowing sand, the turbidity developed for the dustpan dredge can be very small. Significant turbidity is expected at the bottom because of the water jets. In 1982, Amalgamated Dredge Design carried out dredging tests using a modified dustpan on the James River, Norfolk, VA, for the USACE. Preliminary analysis indicated that turbidity was as high for the dustpan dredge as for the cutterhead. The low output and high turbidity of the dustpan dredge were attributed to the very poor hydraulic radius of the dustpan head, especially when pumping plastic clay. A comparison of the turbidity generated by cutterhead and dustpan dredges in the James River showed that there was no clear advantage to using a dustpan dredge over a cutterhead dredge.

#### B.3.6 Dredge comparisons.

B.3.6.1 The suspended sediment fields around the three commonly used dredge types can be described in general terms of the range of concentrations at surface and bottom and the range of spatial dispersion away from the dredge (Table B-6). Overall, the cutterhead dredge seems to produce the least amount of suspended sediments, followed by the hopper dredge without overflow, and finally the bucket dredge (Wakeman, Sustar, and Dickson 1975; Hayes, Raymond, and McLellan 1984; Raymond 1984). The spatial extent of the plume is greatest for bucket and hopper dredges in both surface and bottom waters. Comparing dredges operating in clay, however, Herbich and Brahme (as cited in Raymond 1984) reported that sediment suspension was similar for a hopper dredge without overflow and a cutterhead dredge, while a bucket dredge could produce about 2.5 times as much sediment suspension. Observed differences among dredge types are largely attributable to the mode of operation of the two general types of dredges (mechanical and hydraulic) as well as operational parameters. Regardless of the type of dredge used, a number of dredge modifications and operational adjustments have been suggested to control sediment suspension (Barnard 1978; Raymond 1984).

Table B-6. General Characteristics of Suspended Sediment (SS) Fields Around Three Commonly Used Dredge Types

Dredge Type	SS Concentrations, mg/L		SS Plume Length, m/ft	
	Surface	Bottom	Surface	Bottom
Cutterhead	0-150	≤500	0-100/0-330	≤500/1,600
Hopper*	0-100	≤500	0-700/0-2,300	≤1,200/3,900
Bucket	0-700	≤1,100	100-600/330-2,000	≤1,000/3,300

Sources: Barnard 1978; Raymond 1984; and McLellan et al. 1989

\* Without overflow

31 Jul 15

B.3.6.2 Worst-case suspended sediment fields for each dredge type, including a hopper dredge operation with overflow, are shown in Figure B-6. A generalized worst-case field was described by LaSalle (1990) as having suspended sediment concentrations greater than or equal to 500 mg/L at distances greater than or equal to 500 m (1,600 ft) from the dredge, with maximum concentrations generally restricted to the lower water column within 50 (165 ft) to 100 m (330), decreasing with distance.

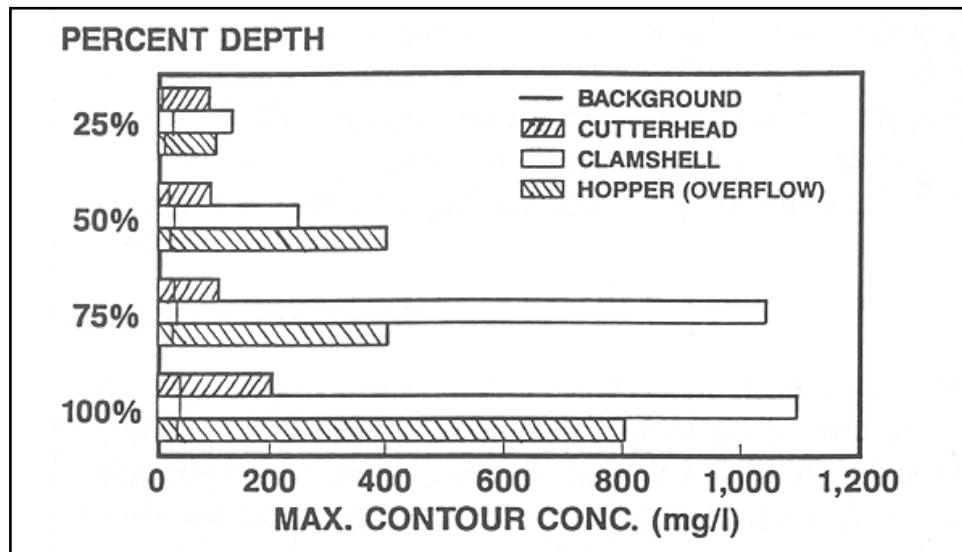

Figure B-6. Worst-Case Suspended Sediment Fields for each Dredge Type

B.3.6.3 Bohlen, Cundy, and Tramontano (1979) described the field around a bucket dredge as a near-field phenomenon and compared it to that produced by storm surges. They pointed out that a single storm surge can introduce baywide as much as 2.5 times the quantities of sediment resuspended by a dredge into the water column, that a storm affects the entire body of water, and that major storms can occur up to four times per year. A dredge, on the other hand, affects a much smaller portion of a given system. Dredging operations have also been compared to other anthropogenic activities that can generate suspended sediments, including shrimp trawling, in the range of 500 to 600 mg/L (Schubel, Carter, and Wise 1979), and ship traffic (Slota et al. 1973), which affects a given channel year-round.

#### B.4 Measures to Reduce Sediment Resuspension.

B.4.1 Fine-grained drained material. One of the major concerns about dredging operations involves the possible environmental impact associated with the resuspension and subsequent dispersion of fine-grained dredged material. This concern is particularly significant considering the fact that the vast majority of potentially toxic chemical contaminants present in bottom sediments is associated with the fine-grained fraction, which is most susceptible to dispersion (Barnard 1978). Under certain environmentally or aesthetically sensitive circumstances, control of this dispersion may be advisable. Various measures and devices used to reduce sediment resuspension in the dredging process for different types of dredges are briefly described in the following paragraphs.

B.4.2 Factors controlling resuspension. The nature, degree, and extent of dredged material dispersion around a dredging operation are controlled by many factors, as indicated previously. The relative importance of these factors varies from site to site. The sediment resuspension and its dispersion would be different depending upon the type of dredge and the dredging operation, the nature of the bed material, and the environmental conditions. The skills of the operator are also very important.

#### B.4.3 Cutterhead dredges.

B.4.3.1 Huston and Huston (1976) discussed in detail the various measures to reduce sediment resuspension by the present dredges and dredging procedures. Design of the cutterhead assumes great importance in the production and sediment resuspension by the dredge during the dredging process. The dredge suction, which picks up the material that has been cut by the cutter, can be partially responsible for sediment resuspension around the cutter if the energy provided to the suction by the dredge pump is not great enough to pick up all of the material disturbed by the cutter. Water-jet booster systems or ladder-mounted submerged pumps installed on cutterhead dredges have been found to enhance the pickup capability of the dredge, increase the slurry density and potential production rate, and decrease sediment resuspension (Barnard 1978). According to Huston and Huston (1976), a proper cutter-suction combination can help achieve the necessary increase in output and reduction in sediment resuspension.

B.4.3.2 The operational parameters of the cutterhead—such as the cutter rotation rate, swing rate, and thickness of the cut—affect sediment resuspension at the cutter and must be controlled relative to the production of the dredge. After studying in detail the operational techniques of cutterhead dredges, Huston and Huston (1976) found that the leverman's techniques for operating a dredge assume great importance in increasing production and minimizing sediment resuspension. These techniques are given by Barnard (1978) as follows:

a. Large sets and very thick cuts should be avoided since they tend to bury the cutter and may cause high levels of suspended solids if the suction cannot pick up all of the dislodged material.

b. The leverman should swing the dredge so that the cutter covers as much of the bottom as possible. This action minimizes the formation of windrows or ridges of partially disturbed material between the cuts; these windrows tend to slough into the cuts and may be susceptible to resuspension by ambient currents and turbulence caused by the cutter. Windrow formation can be eliminated by swinging the dredge in close, concentric arcs over the dredging area. This may involve either modifying the basic stepping methods used to advance the dredge or using a wagger or spud carriage system.

c. Side slopes of channels are usually dredged by making a vertical "box cut"; the material on the upper half of the cut then sloughs to the specified slope, which should be cut by making a series of smaller boxes. This method, called stepping the slope, will not eliminate all sloughing, but it will help reduce it.

d. On some dredging projects, it may be more economical to roughly cut and remove most of the material, leaving a relatively thin layer for final cleanup after the project has been roughed

31 Jul 15

out. This remaining material may be subject to resuspension by ambient currents or propwash from passing ship traffic.

e. When “layer cutting” is used, the dredge removes a single layer of material over a large portion of the channel; the dredge is then set back to dredge another layer. This continues down to the required depth of the project. Since loose material is often left on the bottom after each layer is dredged, this technique should be used only where resuspension of the remaining material will not create serious problems.

f. The propwash from the tenders (tugboats) used to move anchors, sections of pipeline, barges, and the dredge itself can resuspend a great deal of bottom material, especially in shallow water adjacent to the channel. Although propwash cannot be eliminated, oversize tenders should not be used in shallow-water areas.

g. In addition to propwash, significant resuspension of bottom material often occurs when the anchors used in support of the operation are dragged along the bottom while the dredge is being moved to a new location. Anchor dragging should be avoided.

h. During the course of a typical operation, the length of the pipeline may have to be adjusted by adding or removing sections. Before the pipeline is broken, it should be flushed thoroughly with water, not only to prevent clogging when pumping is resumed, but also to maintain low turbidity levels around it. Obvious leaks from poorly sealed ball joints between pipeline sections should also be repaired.

#### B.4.4 Hopper dredges.

B.4.4.1 In the case of hopper dredges, the most obvious source of near-surface turbidity is the overflow water. Japan has developed a relatively simple submerged discharge system for hopper dredge overflow (Ofuji and Naoshi 1976). The overflow collection system in the dredge was streamlined to minimize incorporation of air bubbles, and the overflow discharge ports were moved from the sides to the bottom of the dredge hull. With this arrangement, the slurry descends rapidly to the bottom with a minimum amount of dispersion within the water column. The system can be incorporated in the existing dredges through simple modifications of existing overflow systems.

B.4.4.2 There are various other techniques by which the turbidity in the overflow of the hopper is reduced. One of the techniques is to reduce the flow rate of the slurry being pumped into the hoppers during the latter phases of the hopper-filling operation (deBree 1977). By using this technique, the solids content of the overflow can be decreased substantially—from 200 to 100 mg/L or less (Barnard 1978)—while the loading efficiency of the dredge is simultaneously increased. Among other techniques, increasing the rate of settling of sediments in the hopper by adding flocculant has been attempted by several researchers (Barnard 1978). These techniques, however, have not been found to be very effective, primarily because of the high solids content of the slurry (Barnard 1978).

B.4.4.3 In the case of trailing suction hopper dredges, turbidity resulting from overflow is generated at the surface whereas turbidity caused by the draghead pulling through the soil is



along the bottom. The turbidity generated at the draghead is low compared with that at the overflow. At present, no techniques can be found in the literature to reduce turbidity generated at the dragheads.

## B.5 Dissolved Oxygen (DO) Reduction and Contaminant Mobilization.

### B.5.1 Dissolved oxygen reduction.

B.5.1.1 Dredging-induced dissolved oxygen (DO) reduction in the water column around a dredge or placement operation is a direct consequence of the suspension of anoxic sediment material and results in the creation of both chemical and biological oxygen demands. Available information about DO depletion around dredged material placement operations (Biggs 1970; U.S. Fish and Wildlife Service 1970; May 1974; Slotta et al. 1973; Westley et al. 1973; Smith et al. 1976; Wright, Mathis, and Brannon 1978) suggests that within the placement plume levels in DO reach zero, but that DO depletion is often difficult to detect from background away from the plume. Dissolved oxygen depletion around dredging operations has been reported at varying levels (Brown and Clark 1968; Slotta et al. 1973; Markey and Putnam 1976; Smith et al. 1976; Sustar, Wakeman, and Ecker 1976; U.S. Army Engineer District, Portland, 1982; Lunz, LaSalle, and Houston 1988; Houston, LaSalle, and Lunz 1989).

B.5.1.2 DO levels around a bucket dredge were depleted in a highly industrialized channel in New York (Brown and Clark 1968) by 16-83% in the middle-to-upper water column and by as much as 100% in near-bottom waters. A cutterhead dredge operation in Grays Harbor, WA (Smith et al. 1976), caused periodic reductions in bottom water DO by as much as 2.9 mg/L (about 35% of ambient). Reduction in DO (from 1.5 to 3.5 mg/L and from 25% to 30% of ambient) associated with a hopper dredge operation in a tidal slough in Oregon (U.S. Army Engineer District, Portland, 1982) was restricted to slack-water conditions in the lower third of the water column. When tidal flow resumed (within 2 hours), DO levels increased by as much as 2 mg/L under floodwater conditions. The effect of a bucket dredge operation on DO in the Hudson River, NY (Lunz, LaSalle, and Houston 1988; Houston, LaSalle, and Lunz 1989), was minimal (generally <0.2 mg/L) in the immediate vicinity of the dredge during dredging. Percent DO saturation on a baywide basis was also minimally reduced (by 10%) corresponding to a drop in DO of about 1 mg/L. Other studies have reported minimal or no measurable reduction in DO around dredges (Slotta et al. 1973; Markey and Putnam 1976; Sustar, Wakeman, and Ecker 1976).

B.5.1.3 A review of the processes associated with DO reduction (Lunz and LaSalle 1986) suggested that DO demand is a function of the amount of suspended sediment being placed into the water column, the oxygen demand of the sediment, and the duration of resuspension. While the high levels of suspended sediment (tens of grams) associated with the fluid mud layer of placement operations may reduce DO levels substantially, the relatively low levels of suspended sediment associated with a cutterhead operation are predicted to have a relatively small effect on DO (Lunz and LaSalle 1986).

B.5.1.4 Efforts to predict DO depletion around dredging operations (Lunz and LaSalle 1986; Lunz, LaSalle, and Houston 1988) have been based on the assumption that any reduction in DO is the direct consequence of oxidation of suspended reduced constituents in anoxic sediments.

Two basic models of DO reduction have been developed, differing only in the kinds of material causing DO demand and the relative time interval over which the reactions are expected to occur. One model was based on levels of total organic carbon (TOC) and an estimated relationship with volatile solids, which can act over hours or days. A second model was based on measurements of the most commonly encountered reactive chemical components found in estuarine sediments (ferrous iron and free sulfides), which would create an immediate oxygen demand.

B.5.1.5 Both models predicted minimal DO depletion (from 0.5 to 1.9 mg/L) around a bucket dredge operation. Results of actual monitoring of DO around a dredge (Houston, LaSalle, and Lunz 1989) showed minimal (<0.2 mg/L) immediate DO depletion in the immediate vicinity of the dredge, which was difficult to detect relative to background fluctuations of as much as 1 mg/L. Baywide monitoring, however, showed slightly greater levels of DO depletion (measured as percent saturation) by as much as 10% (about 1 mg/L). Predicted values based on iron and sulfur levels appeared to be a better predictor of immediate reductions while those based on TOC appeared to be a better predictor of baywide conditions. Given the relatively low levels of suspended material generated by dredging operations and considering factors such as flushing (not accounted for in either model), DO depletion around these operations should be minimal.

#### B.5.2 Chemical contaminant mobilization.

B.5.2.1 The release of naturally occurring (such as nutrients, sulfides, and iron) and industrially derived (such as metals, organohalogens, and pesticides) substances by the suspension of sediments during dredging or dredged material placement is of particular interest when contaminated sediments are known or suspected to be involved. As with DO reduction, most available information comes from studies of dredged material placement (reviewed by Lee et al. 1975; Chen et al. 1976; Burks and Engler 1978; Stern and Stickle 1978), which indicate that the levels are generally low and that releases are highly transient. The processes involved with the fate of these compounds have been studied, and Lunz and LaSalle (1986) provide a condensed review of the information concerning these processes and associated controlling factors.

B.5.2.2 In general, most metals and other compounds are generally not readily available in a soluble form in the water column, but only as part of an iron complex or in association with organic matter and clays (Windom 1972, 1976; May 1974). Reduced iron, once oxidized during suspension of sediment material, actively scavenges metals and other compounds. As these compounds settle to the bottom, they are again reduced under anoxic conditions. Similar associations of chlorinated hydrocarbons with silts, clays, and organic detritus also limit their availability as soluble forms.

B.5.2.3 The effect of release of nutrients such as nitrogen and phosphorus via sediment suspension varies. Both beneficial (stimulated photosynthesis) and detrimental (excessive biological growth, ammonia toxicity) effects have been documented in aquatic ecosystems.

B.5.2.4 Direct measurements of chemical releases around dredging operations are reported in Smith et al. (1976), Wakeman (1977), Tramontano and Bohlen (1984), and Havis (1988b). Wakeman (1977) reported significantly higher concentrations of four metals in San Francisco Bay. Average concentrations (filtered water) above background in surface samples were 0.16 mg/L for zinc, 0.01 mg/L for lead, 0.03 mg/L for chromium, and 0.01 mg/L for nickel. Bottom

sample levels were 0.05 mg/L for chromium and 0.08 mg/L for nickel. Copper and mercury levels were unaffected by dredging. Smith et al. (1976) observed elevated concentrations of sulfides (range 3.9 to 1,690 g/L) in Grays Harbor, with levels generally <50 µg/L. Tramontano and Bohlen (1984) observed elevated quantities of phosphate, ammonia, and silica in near-bottom waters within 180 m of the dredge and elevated amounts of manganese and copper within 12 m; cadmium levels were unaffected. While concentrations of these compounds in the immediate vicinity of the dredge (3-6 m [10-20 ft]) exceeded background levels by as much as 2-9 times, the absolute levels remained low: 17.1 µM/L for ammonia, 1.0 µM/L for phosphate, 14.5 µM/L for silica, 0.4 µM/L for manganese, and 0.1 µM/L for copper. These authors also suggested that, when compared with background levels of the whole system, dredging operations would increase these constituents by no more than 2% for ammonia, 1% for phosphate, 0.5% for silica, 0.1% for manganese, and 0.2% for copper. Studies of release of contaminants associated with dredging of contaminated sediments at three sites (Havis 1988a) serve to provide some comparative information (Table B-7). Relative levels for chemical species common between sites were similar.

Table B-7. Average Concentrations (mg/L, Absolute Values) of Selected Contaminants Released During Dredging of Contaminated Sediments

Site	Compound									
	Zn	Pb	Cu	Cd	Hg	As	Cr	Ni	Mn	Fe
Black Rock Harbor, CT	0.03	0.003	0.01	0.001	0.0001	0.01	0.001	0.01	0.12	0.70
Duwamish River, WA	0.02	0.007	0.002							
James River, VA	0.002	0.009	0.01	0.003						

Source: Havis 1988a

## B.6 Biological Considerations.

B.6.1 This paragraph summarizes the available technical literature concerning impacts to biological resources from physical and chemical environmental alterations associated with dredging activities (primarily from LaSalle 1990). Clarke and Wilber (2000) summarize the known biological responses of estuarine and coastal fish and shellfish to suspended sediments and relate these findings to suspended sediment conditions associated with dredging projects. An objective approach toward evaluation of sediment resuspension impacts, which requires full consideration of the following, is proposed:

a. The existing state of knowledge concerning the effects of suspended sediments on fish and shellfish, including recognition of the gaps therein.

b. Concentration-exposure duration combinations likely to be encountered by organisms in the vicinity of dredging operations.

Exposure of organisms to sediments in the water column will be addressed first, and effects of deposited sediments will be treated separately later.

B.6.2 Wilber et al. (2005) summarize the current scientific literature with emphasis on effects of uncontaminated, bedded sediments on estuarine and marine organisms. This review consolidates existing information on sedimentation effects, identifies aspects of natural and anthropogenic sedimentation processes that may be problematic, and identifies gaps in the current state of knowledge necessary for prudent dredging project management and resource protection.

B.6.3 While the understanding of the potential effects of far-field sediment deposition is limited, some estuarine organisms may be highly sensitive to suspended sediments. Certain life stages (eggs, juveniles) may be particularly affected by resuspension and deposition. Germano and Cary (2005) review potential impacts of sedimentation (bedded materials) with emphasis on those habitats believed to be most sensitive.

B.6.4 Major classes of alterations include suspended sediments, sedimentation, chemical release, DO reduction, channel blockage, and entrainment. Major categories of biological resources include fishes, shrimps and crabs, shellfishes (for example, oysters and clams), benthic assemblages, a miscellaneous group that includes threatened or endangered species (for example, marine mammals and sea turtles), and colonial-nesting birds.

B.6.5 Of these alterations, the bulk of available information comes from studies of effects of suspended sediments, sedimentation, and to some degree, entrainment. For this reason, information on these classes of alterations is presented under each of the major categories of resources except endangered species, for which there is a unique set of alterations. Each section on a given class of alteration includes a brief summary and general conclusions. For the remaining classes of alterations, discussions are based largely on the potential effects of these alterations and available information on the degree of each. It should be noted that these discussions are presented not as exhaustive reviews of all available information but for the purpose of providing pertinent information relative to dredging issues. Morton (1977), Allen and Hardy (1980), Profiles Research and Consulting Groups, Inc. (1980), and Kantor (1984) provide similar reviews on these topics. When references giving more extensive information on a given topic are available, they are listed in the text.

B.6.6 An attempt has been made to separate discussions of various effects by life history stage, when possible. The reason for this approach is to emphasize the realization that the early life history stages of most organisms are generally more sensitive or susceptible to environmental alterations than are adult stages. Therefore, it is important to consider effects on each life stage when reviewing a project.

## B.7 Effects of Environmental Alterations on Fishes.

### B.7.1 Introduction.

B.7.1.1 The ultimate survival and strength of a given year class of fishes are determined largely by events that occur during egg and larval developmental stages. The relative success or failure of transitions through critical phases, such as at the time of first exogenous feeding (that is, deriving nutrition from planktonic prey rather than yolk reserves) or during metamorphosis from larval to juvenile form, can be influenced by extant environmental conditions. In

comparison with juvenile and adult fishes, egg and larval stages seem generally more sensitive to stress of whatever origin (Rosenthal and Alderdice 1976). Also, because of their dependence on local hydrodynamic conditions for transport into and out of project areas and limited or non-existent escape capabilities, egg and larval stages have been asserted to be more susceptible to the effects of unfavorable environmental conditions than motile juvenile and adult life history stages (Auld and Schubel 1978). As a result, resource agency concerns over detrimental effects of dredging and placement operations have focused on how environmental alterations affect egg and larval stages of marine and estuarine species. In addition, concerns regarding anadromous fishes involve the supposition that turbidity fields constitute a barrier to migration of adult and juvenile fishes and a concern about entrainment of eggs, larvae, and juveniles by hydraulic dredges.

B.7.1.2 Two basic reproductive patterns that occur among fishes are important considerations in relation to dredging operations. Many coastal or estuarine-dependent species produce pelagic eggs (free-floating, unattached, or in gelatinous masses), which, depending on their specific gravities, may occur at various levels in the water column from surface to bottom. Potential impacts on pelagic eggs may therefore be related to both spatial distributions of suspended sediments and duration of exposure to specific concentrations. In the case of most estuarine-dependent species, however, this life stage occurs in offshore water away from most dredging and placement operations. Other fish species, including anadromous species, produce demersal, nonbuoyant eggs that may either adhere to substrates at the spawning site, and therefore remain in place for short to extended periods prior to larval hatching and release, or are carried downstream in bottom currents. In addition to the problem of exposure duration, demersal eggs may be subject to burial by accumulated deposited sediments and/or entrainment by suction dredges.

#### B.7.2 Suspended sediments.

B.7.2.1 The causal factors by which suspended sediments affect eggs and larval fishes are complex. Cairns (1968) provided a detailed summary of these factors, which include direct mechanical abrasion of egg and larval surficial membranes, reduction of available light in the water column, and sorption of contaminants carried by the sediments. Indirect effects of elevated suspended sediments may also be of consequence. Examples include interference with feeding behavior of visually oriented larvae or delayed development resulting in asynchronous occurrences of larvae and their prey. Very little is known of the importance of synergistic effects resulting from combinations of causal factors or how physical features of the suspended particles, such as size or angularity, contribute to the effects observed. Stresses caused by chemical, physical, or biological conditions may be manifested in chronic rather than acute biological responses (Sherk 1972), further complicating the determination of detrimental effects.

B.7.2.2 Given these complexities, it is difficult to draw clear conclusions from published studies on effects of suspended sediments on fish eggs and larvae. Because they do not produce accurate quantitative mortality estimates, information that is critical to assessing project impacts (Dovel 1970), field studies have yielded largely inconclusive results (for example, Flemer et al. 1967). The dual constraints of logistics and the inability of field designs to isolate effects of experimental factors have relegated meaningful studies to the laboratory.

31 Jul 15

B.7.2.3 A meaningful summary of laboratory results is hindered by the lack of standardization in experimental protocol (for example, selection of test concentrations, exposure durations, or suspensions of natural versus processed sediments) and equipment used to maintain sediments in suspension. A review of studies evaluating suspended sediment effects on fish eggs and larvae is provided by Schubel, Williams, and Wise (1977). A number of pertinent references on this issue are products of investigations in the upper Chesapeake Bay system, particularly in connection with striped bass spawning grounds in the vicinity of the Chesapeake and Delaware Canal (Schubel and Wang 1973; Auld and Schubel 1978; Priest 1981; Morgan, Rasin, and Noe 1983). Table B-8, although not a comprehensive compilation, represents a sample of the results of relevant investigations.

B.7.2.4 Laboratory studies have focused on three aspects of responses of fish eggs and larvae to elevated, suspended concentrations. Effects have been demonstrated at various levels of suspended sediment concentrations in terms of percent successful hatch of eggs, time elapsed between fertilization and hatching, and percent survival of larvae after known durations of exposure. For example, Schubel, Williams, and Wise (1977) concluded that striped bass eggs (semibuoyant) can tolerate very high suspended sediment levels ( $\geq 1,000$  mg/L) for periods of many hours. Similarly, Kiorboe et al. (1981) reported that embryonic development and hatching of herring (*Clupea harengus*) were unaffected by either long-term exposure (10 days) to low to moderate concentrations (5 to 300 mg/L) of suspended silt or short-term exposure (2 hours) to higher concentrations (500 mg/L) of silt.

B.7.2.5 There is some indication that larval stages may be more sensitive to elevated suspended sediment concentrations than are eggs of the same species. For example, Auld and Schubel (1978) reported that striped bass, yellow perch, and American shad larvae were less tolerant than eggs of these respective species at equivalent experimental suspended sediment concentrations. This trend may be attributable to loss of protection provided by the chorion (outer egg membrane) upon hatching of the larvae (Boehlert 1984). Additionally, many fish larvae are highly dependent on the epidermis as a respiratory surface. Adhesion of sediment particles to the epidermis may exert a smothering effect although adhesion was noted by Boehlert (1984) only at concentrations above 1,000 mg/L, which is well above that found in dredging operations. Priest (1981) critically reviewed the literature pertaining to effects of total suspended solids on fish eggs. He concluded that for the four species considered, the only effect caused by the highest levels of suspended solids expected at a dredging operation was a slight delay in time to hatching. Lethal concentrations sufficient to produce a 50% mortality in laboratory experiments of larvae of the studied species were far in excess of levels characteristic of dredging operations.

Table B-8. Results of Experimental Determinations of Effects of Suspended Sediments on Various Life History Stages of Fishes (modified from Priest 1981)

Species	Stage	Suspended Sediment Concentration mg/L	Exposure Duration	Type of Sediment	Degree of Effect	Reference
Yellow perch White perch Striped bass Alewife	Eggs	500	Not stated	Natural	No significant effect on hatching success; some time delay in hatching noted in samples at ~100 mg/L (all species)	Schubel and Wang (1973)
White perch	Eggs	50-5,250	Not stated	Natural (fine)	No significant effect on hatching success; definite delay in development at $\geq 1,500$ mg/L	Morgan, Rasin, and Noe (1983)
Striped bass	Eggs	20-2,300	Not stated	Natural (fine)	No significant effect on hatching success; definite delay in development at $\geq 1,300$ mg/L	
Atlantic herring	Eggs	5-300 500	10 days 2 hrs	Natural	No significant effect on development or hatching success	Kiorboe et al. (1981)
Blueback herring Alewife American shad Yellow perch	Eggs	50-5,000	Not stated	Natural (fine)	No significant effect on hatching success at all test concentrations	Auld and Schubel (1978)
White perch	Eggs	50-5,000	Not stated	Natural (fine)	Significant effect on hatching success at 1,000 mg/L, but not at lower concentrations	
Striped bass	Eggs	50-5,000	Not stated	Natural (fine)	Significant effect on hatching success at 1,000 mg/L, but not at lower concentrations	
White perch	Larvae	1,626-5,380	24-48 hrs	Natural (fine)	15-49% mortality	Morgan, Rasin and Noe (1983)

(continued)

31 Jul 15

Species	Stage	Suspended Sediment Concentration mg/L	Exposure Duration	Type of Sediment	Degree of Effect	Reference
Striped bass	Larvae	1,557-5,210	24-48 hrs	Natural (fine)	20-57% mortality	
Yellow perch	Larvae	50-1,000	4 days	Natural	Survival significantly reduced at $\geq 500$ mg/L	Auld and Schubel (1978)
Striped bass	Larvae	50-1,000	2-3 days	Natural	Survival significantly reduced at $\geq 500$ mg/L	
Alewife	Larvae	50-1,000	4 days	Natural	Survival significantly reduced at $\geq 500$ mg/L	
Spot	Adult	13,090	24 hr	Artificial	LC <sub>10</sub>	Sherk, O'Connor, and Neumann (1975)
Striped killifish		68,750		Natural		
Mummichog		23,770		Artificial		
Atlantic silverside		97,200		Natural		
Bay anchovy		24,470		Artificial		
White perch		580		Artificial		
		2,300		Artificial		
		9,970		Natural		
		3,050		Artificial		
Striped bass	Sub-adult	4,000	21 days	Natural	LC <sub>10</sub>	Peddicord and McFarland (1978)
Cunner	Adult	133,000	12 hr	Natural	Median tolerance limit	Rogers (1969)
		100,000	24 hr	(silt)		
		72,000	48 hr			
Mummichog	Adult	300,000	24 hr	Natural (silt)	No mortality	
Sheepshead Minnow	Adult	300,000	24 hr	Natural (silt)	< 30% mortality	
Cunner	Adult	100,000	24 hr	Natural (silt)	Median tolerance limit	
Stickleback	Adult	52,000	24 hr	Natural (silt)	Median tolerance limit	



B.7.2.6 Mechanical abrasion has been identified by Cairns (1968) as an important suspended sediment effect, yet little attention has been given to differential effects of sediments of different particle characteristics. The premise here is that delicate surficial membranes such as gills or the epidermis of larval fishes are particularly susceptible to abrasive damage. Several lines of evidence support this view. Rogers (1969) reported that processed sediments (highly angular incinerator residues) were much more toxic to experimental fishes than were naturally weathered estuarine sediments. Coarse sediments were also shown to exert greater detrimental effects on fish survival rates than fine sediments of equal concentration. Boehlert (1984) compared the effects of natural, weathered estuarine sediments to those of sharp, angular Mount St. Helens volcanic ash on yolk sac larvae of Pacific herring (*Clupea harengus pallasii*). Severe abrasion and puncture damage of larval epidermal membranes were observed via light and electron microscopy at volcanic ash concentrations of 1,000 mg/L whereas comparable effects were evident for natural sediments only at concentrations at or above 4,000 mg/L (all larvae exposed to experimental concentrations for 24 hours). Although larvae did not show significant mortality at any experimental concentration (up to 8,000 mg/L), observed effects could represent sublethal stress that may contribute to later mortality.

B.7.2.7 Although juvenile forms might be suspected to be somewhat less tolerant of elevated suspended sediment concentrations than adults, the literature is sparse and incomplete on the direct physical effects of elevated suspended sediment concentrations on juvenile stages. Wallen (1951) exposed both adults and juveniles of a number of freshwater fish species to a wide range of silt-clay suspensions, all of which were well above concentrations found under typical dredging conditions. While results for juveniles were not presented separately, he concluded that direct effects of turbidity due to montmorillonite (hydrated aluminum silicate) type silt-clay is not a lethal condition and seldom produced observable symptoms in juvenile or adult fish. Sherk, O'Connor, and Neumann (1975), working with juvenile Atlantic menhaden (*Brevoortia tyrannus*), determined that a lethal concentration producing 10% mortality ( $LC_{10}$  value) of 1,540 mg/L was obtained after a 24-hour exposure to Fuller's earth (a combination of clay and siliceous material). Jeane and Pine (1975) compared the effects of elevated turbidities at dredging sites characterized by suspension of fine versus coarse sediments through in situ bioassays using juvenile chinook salmon. No significant mortality was observed among juveniles exposed to fine sediment suspensions. Exposure to coarse sediments led to mortalities, but these were greater at stations away from the actual dredging site. This led the authors to suggest that toxic contaminants or some other artifact confounded the results.

B.7.2.8 Determination of direct physical effects of elevated suspended sediment concentrations on adult fishes lends itself to both field and laboratory examination. As a result, a considerable body of relevant literature exists (Table B-8). Interpretation of this literature, however, is limited by the lack of standardization among experiments and differing experimental protocols. The most widely used approach employs basic bioassays in which fishes are exposed to incremental concentrations of suspended sediments until some lethal concentration is determined, generally that which produces a 10% or 50% mortality ( $LC_{10}$  or  $LC_{50}$ ) after a specified period (for example, Sherk, O'Connor, and Neumann 1975; O'Connor, Neumann, and Sherk 1976; Peddicord and McFarland 1978). Another common approach is to measure threshold concentrations of suspended sediments above which a given species is adversely affected.

B.7.2.9 A widely referenced study on 16 species of freshwater fishes (Wallen 1951) found lethal turbidity thresholds to be equal to or greater than 16,500 mg/L following exposure durations ranging from 3.5 to 17 days. Behavioral signs of stress for most species were not apparent at suspended sediment concentrations under 20,000 mg/L. Peddicord and McFarland (1978) determined that rainbow trout showed no significant mortality after 22 days at concentrations below 2,000 mg/L, and 95% survival occurred at concentrations approaching 4,300 mg/L. Although under less controlled conditions, other studies exposing caged specimens to in situ levels of suspended and deposited sediments at actual dredging sites (Ingle 1952; Ritchie 1970) have reported little or no detrimental effect.

B.7.2.10 Several workers have employed histological preparations of gill tissues to demonstrate effects of elevated suspended sediments. Ritchie (1970) found no evidence of gill pathology in specimens of 11 estuarine fish species prior to and after exposure to dredging conditions. Sherk, O'Connor, and Neumann (1975), however, found disrupted gill tissue and increased mucus production in white perch exposed to sublethal suspended sediment concentrations (650 mg/L).

B.7.2.11 Based on studies conducted to date (Table B-8), all life stages of estuarine-dependent and anadromous fish species appear to be fairly tolerant of elevated suspended sediment concentrations. In all probability, fishes that use naturally turbid habitats as spawning and nursery grounds are adapted to and highly tolerant of elevated suspended sediment concentrations, which, in some cases (for example, striped bass), correspond to periods of greatest ambient suspended sediment levels. Such conditions would not be expected to prevail at a dredge site for sufficient lengths of time to merit special concern; however, placement operations may be of such duration as to cause concern. These investigations suggested that a conservative safe level at which no impact would be anticipated would be 500 mg/L. A strong case can be presented that a 1,000-mg/L limit would also be acceptable.

### B.7.3 Sedimentation.

B.7.3.1 A number of fish species deposit demersal (often adhesive) eggs that generally remain in place on the bottom until larval hatching. There is a concern that heightened sedimentation rates in project areas may lead to smothering of these eggs. Morgan, Rasin, and Noe (1983) studied effects of sediment deposition on white perch (*Morone americana*) eggs and showed that hatching was not significantly affected by sediment layers 0.45 mm or less thick (egg diameter approximated 0.9 mm). Sediment layers 0.5-1.0 mm thick resulted in over 50% mortality, and a deposited sediment layer 2.0 mm thick caused nearly 100% mortality.

B.7.3.2 Naqvi and Pullen (1982) reviewed the impacts of beach nourishment projects on fishes, suggesting that these operations may have significant effects on deposited eggs of spawning species. Parr, Diener, and Lacy (1978), however, observed that beach nourishment apparently did not affect subsequent spawning activity of grunion (*Leuresthes tenuis*). Juveniles and adults of practically all fishes are sufficiently mobile to avoid burial due to increased sedimentation rates or prolonged exposures to suspended sediments at a dredging site. Fishes generally return shortly after the disturbance ceases (Courtenay et al. 1972; Parr, Diener, and Lacy 1978; Reilly and Bellis 1978, 1983; Courtenay, Hartig, and Loisel 1980; Holland, Chambers, and

Blackman 1980). The major impact on these stages is the potential loss of benthic food resources.

B.7.3.3 Given the potential deleterious effects of sedimentation on demersal eggs of fishes, precautions should be considered (including the option for seasonal restrictions) if the path of dredging activities ties within an identified fish spawning area. This is especially important in water characterized by slack-water or low-flow conditions where high sedimentation rates will occur following suspension of sediments by dredging or placement activities. Under certain conditions (for example, when coarse sand is involved), effects of sedimentation may be confined to a much smaller area.

#### B.7.4 Entrainment.

B.7.4.1 Both demersal and pelagic fish eggs and larvae are susceptible to entrainment by suction dredges due to their inability to escape the suction field around the intake pipe (McNair and Banks 1986). Demersal eggs and larvae may be picked up directly with the sediment while pelagic forms may be drawn in from the surrounding water column. Of particular concern is the potential entrainment of fishes exemplified by migrating salmon fry. Depending on the species, fry may be present at various times of the year either throughout the water column or restricted to different portions of it (usually the upper portions), thereby affecting the potential for entrainment.

B.7.4.2 Arseneault (1981) reported rates of entrainment for chum and pink salmon fry by hydraulic dredges to be within the range of 0.04-0.00004% of the total migration in the Fraser River (Canada) in 1981. While these estimates appear very low, the operation of the dredges involved was modified to avoid migrating fry by restricting operations to water depths in excess of 3-4.6 m (10-15 ft) and by restricting the activation of suction pumps to within 1.5 m (5 ft) from the bottom. Mortality of entrained fry was, for all practical purposes, 100%, since the majority of fry were buried by sediment in the disposed material, while the remainder suffered abrasion of external and gill surfaces. Boyd (1975) reported 98.8% mortality for fry entering a pipeline dredge and observed that eggs entrained by both pipeline and hopper dredges were killed by the action of the dredge.

B.7.4.3 Entrainment rates for several species of fishes were reported by Armstrong, Stevens, and Hoeman (1982) for Grays Harbor, WA, and by Larson and Moehl (1990) for the mouth of the Columbia River, OR and WA (Table B-9). Armstrong, Stevens, and Hoeman (1982) reported species-specific rates ranging from 0.001 to 0.135 fish/yd<sup>3</sup>, which included several commercially important species. Both large (up to 234 mm [9.2 in.]) and small fishes were entrained; however, comparisons with trawl data indicated that many species were apparently capable of avoiding the dredge. Larson and Moehl (1990) reported average rates of entrainment, ranging from 0.001 to 0.38 fish/yd<sup>3</sup> of material dredged. The only species consistently entrained at moderate levels (range 0 to 18.89 fish/ yd<sup>3</sup>) was the bottom dwelling sand lance (*Ammodytes hexapterus*). Entrainment of commercially important salmonids was reported only for a single species (chum salmon) at low levels in Grays Harbor (Table B-9). Reine, Dickerson, and Clarke (1998) summarize existing literature regarding potential impacts to aquatic organisms caused by entrainment during dredging operations.

31 Jul 15

Table B-9. Entrainment Rates (Organisms/Yd<sup>3</sup> Dredged) of Fishes Reported for Dredges in Grays Harbor, WA, and the Columbia River, OR and WA

Species	Pipeline <sup>1</sup>	Hopper <sup>1</sup>	Hopper <sup>2</sup>
Staghorn sculpin <i>Leptocottus armatus</i>	0.001	0.016-0.092	>0.01
Pacific sanddab <i>Citharichthys sordidus</i>		0.003-0.076	
Pacific tomcod <i>Microgadus proximus</i>		0.008	>0.001
Snake prickleback <i>Lumpenus sagitta</i>		0.008-0.135	
Prickly sculpin <i>Cottus asper</i>	0.004	0.020	
Saddleback gunnel <i>Pholis ornate</i>	0.023	0.005	
Three-spined stickleback <i>Gasterosteus aculeatus</i>	0.004		
English sole <i>Parophrys vetulus</i>	0.001	0.035	
Northern anchovy <i>Engraulis mordax</i>		0.018	
Sand sole <i>Psettichthys melanostictus</i>		0.003	
Speckled sanddab <i>Citharichthys stigmaeus</i>		0.003	
Lingcod <i>Ophiodon elongatus</i>		0.002	
Pacific sandfish <i>Trichodon trichodon</i>		0.002	>0.001
Chum salmon <i>Oncorhynchus keta</i>	0.008		
Sand lance <i>Ammodytes hexapterus</i>			0.38
Showy snailfish <i>Liparis pulchellus</i>			>0.01
Eulachon <i>Thaleichthys pacificus</i>			>0.01
Cabezon <i>Scorpaenichthys marmoratus</i>			>0.01
Spiny dogfish <i>Squalus acanthias</i>			>0.001

(continued)

Species	Pipeline <sup>1</sup>	Hopper <sup>1</sup>	Hopper <sup>2</sup>
Big skate <i>Raja binoculata</i>			>0.001
Poacher (Agonidae)			0.01
Perch (Embiotocidae)			>0.001
Gunnel (Pholididae)			>0.001
Juvenile flatfish			0.01
Herring and anchovy			0.01

Sources:

<sup>1</sup> Armstrong, Stevens, and Hoeman (1982)

<sup>2</sup> Larson and Moehl (1990)

B.7.4.4 Although reported entrainment rates for fishes (in the northwest) are low, the potential for entrainment may increase if operations occur during migration periods and work is in heavily used narrow-channel habitats. For example, Arseneault (1981) recommended that for riverine habitats in the Canadian Pacific Northwest, suction dredging should be permitted only in water that is at least 4.6 m (15 ft) deep during the migratory period of salmonid fry and that the cutterhead be at least 1.5 m (5 ft) from the bottom before the pump is activated. Both suggestions would minimize entrainment of fry in the upper water column. Restrictions would also be recommended when dredging in known spawning grounds to avoid entrainment of eggs. Partial restrictions may be appropriate in bodies of water of larger dimensions (>300 m [1000 ft] wide) in which spawning grounds are present.

B.7.4.5 Paddlefish and sturgeons (*Acipenseriformes*) collectively constitute one of the most imperiled groups of fishes in North America. Some instances of entrainment have been documented by observers on coastal dredges, but effects of entrainment on adult fish are presumed low. For the period 1990-2005, there are fewer than 25 confirmed instances of sturgeon entrainment by dredges operating in Gulf and Atlantic waters (unpublished data, Dena Dickerson, Research Biologist, U.S. Army Engineer Research and Development Center, Vicksburg, MS). Recently, resource agencies have expressed concern that inland dredging may impact populations of some species by entraining juveniles. Small young-of-year fish (<200 mm [8 in.]) are believed to be especially susceptible. Entrained fishes would likely go undetected during normal dredging operations because dredged material discharges are not monitored and because the remains of these largely cartilaginous fishes, especially very small individuals, may be unrecognizable. Risk of entrainment, however, could be estimated by comparing the suction velocities generated by dredges, or “flow fields,” with swimming performance data for these fishes. Hoover et al. (2005) assess potential entrainment-related losses of paddlefish and sturgeons from dredging operations using measures of swimming performance as descriptors of risk.

## B.8 Effects of Environmental Alterations on Shellfishes.

### B.8.1 Introduction.

B.8.1.1 The term “shellfish,” as used here, denotes a catch-all group of largely commercially important invertebrates including mobile crustaceans (such as shrimps and crabs) and sessile molluscs (such as oysters and clams). Marine and estuarine invertebrates display a tremendous diversity of reproductive strategies; nevertheless, analogies can be drawn between potential impacts on invertebrates and those described for fish eggs and larvae in the previous paragraph. The fundamental demersal/pelagic dichotomy among most coastal fish egg and larval stages is somewhat more pronounced among invertebrates. For example, all commercially important crustaceans (such as shrimps, crabs, lobsters) maintain their developing eggs attached to abdominal appendages until hatching, lessening the risk of acute impacts due to dredging operations. However, eggs retained prior to hatching by some forms of sessile invertebrates are subject to the same potential impacts as demersal eggs of fishes. Local hydrodynamic conditions and, in some cases, active movement may contribute to the dispersal and distribution patterns of pelagic invertebrate larvae.

B.8.1.2 Additional concern is warranted with regard to sessile forms of estuarine and coastal invertebrates (such as oysters and clams). Sessile forms, having very limited powers of locomotion, can be assumed to be susceptible to long-term exposures of elevated suspended concentrations in the immediate vicinity of dredging and placement operations. Most shellfishes, adapted to naturally turbid estuarine conditions, have adequate mechanisms (for example, valve closure or reduced pumping activity of oysters) to compensate for short-term exposures. Dredging jobs of long duration (months), however, may exceed these defensive mechanisms.

### B.8.2 Suspended sediments.

B.8.2.1 The literature relevant to this issue has been reviewed by Stern and Stickle (1978) and Priest (1981). Because of their economic importance, crustaceans and bivalve molluscs have received the most attention. Table B-10 summarizes the results of these studies.

B.8.2.2 Shellfish species, particularly benthic forms inhabiting turbid estuaries, are undoubtedly very tolerant of naturally elevated suspended sediment concentrations (for example, concentrations generated during storm events and seasonal flooding conditions or even local wind and tide events) for reasonable durations. Most of the detrimental effects noted in Table B-10 were responses to suspended sediment levels several to many times higher than those occurring at typical dredging operations and for periods of time ranging from 5 to 21 days. Reduced respiratory pumping rates observed by Loosanoff and Tommers (1948) for oysters held at suspended sediment concentrations between 100 and 4,000 mg/L are an example of a compensatory mechanism that enables these sessile bivalves to effectively limit their exposure over at least short-term durations. Davis and Hidu (1969) reported substantial (22%) incidences of abnormal development in American oyster eggs exposed to suspended sediment concentrations within the range expected during dredging operations, although exposure durations were not stated. In contrast, developing oyster and hard clam larvae showed enhanced growth rates at suspended sediment concentrations up to 500 mg/L (Davis 1960; Davis and Hidu 1969). Higher concentrations did hinder growth and result in increased mortality. Bricelj,

Malouf, and de Quillfeldt (1984), however, reported a decreased growth rate of juvenile hard clams at concentrations above 25 mg/L.

Table B-10. Results of Experimental Determinations of Effects of Suspended Sediments on Various Life History Stages of Shellfishes (Modified from Priest 1981)

Species	Stage	Suspended Sediment Concentration mg/L	Exposure Duration	Type of Sediment	Degree of Effect	Reference
American oyster	Eggs	188	Not stated	Artificial	22% abnormal development	Davis and Hidu (1969)
		250		Artificial	27% abnormal development	
		375		Natural (silt)	34% abnormal development	
	Larvae	1,000	12 days	Artificial	No significant effect	
		2,000		Artificial	No significant effect	
		750		Natural (silt)	31% mortality	
		2,000		Artificial	20% mortality	
Hard clam	Eggs	500	Not stated	Artificial	78% mortality	Davis (1960)
		750		Natural (silt)	8% abnormal development	
	Larvae	1,000	12 days	Natural (silt)	21% abnormal development	
		1,500		Natural (silt)	35% abnormal development	
		125		Artificial	18% abnormal development	
		125		Artificial	25% abnormal development	
		4,000		Artificial	31% abnormal development	
		1,000		Natural (silt)	No significant effect	
		500		Artificial	50% normality	
		50,000		Artificial	LC <sub>50</sub>	
Spot-tailed sand shrimp	Adult	50,000	200 hr	Artificial	LC <sub>50</sub>	Peddicord et al. (1975)
Black-tailed sand shrimp	Sub-adult	21,500	21 days	Natural contaminated	20% mortality	Peddicord and McFarland (1978)
Dungeness crab	Adult	3,500	21 days	Natural contaminated	LC <sub>10</sub>	Peddicord and McFarland (1978)
	Juvenile	2,000-20,000	25 days	Natural	No mortality at <4,300 mg/L; 38% mortality at 9,200 mg/L; abnormalities between 1,800 and 4,300 mg/L	

(continued)

Species	Stage	Suspended Sediment Concentration mg/L	Exposure Duration	Type of Sediment	Degree of Effect	Reference
American lobster	Adult	50,000	Not stated	Artificial	No mortality	Saila, Polgar, Rogers (1968)
American oyster	Adult	4,000-32,000	Extended	Not stated	Detrimental	Wilson (1950)
		100-700	Not stated	Mud	No effect	Mackin (1961)
		100-4,000	Not stated	Silt	Reduced pumping	Loosanoff and Tommers (1948)
Blue mussel	Sub-adult	100,000	5 days	Artificial	10% mortality	Peddicord et al. (1975)
	Adult	100,000 96,000	11 days 200 hrs		10% mortality LC <sub>50</sub>	

B.8.2.3 Carriker (1986) provides an excellent review of the literature dealing with suspended sediment effects on oyster larvae. In general, concentrations below about 180 mg/L for embryos (in the egg membrane) and below 500 mg/L for veligers can be beneficial while higher concentrations become increasingly harmful. Suspended sediment apparently has little effect on feeding or movement of larvae through the water column. However, toxic compounds may affect larvae of all stages, and sediment films may affect attachment of larvae to suitable substrates. Peddicord and McFarland (1978) reported that juvenile American lobsters experienced no mortality after 25-day exposures to suspended sediment (contaminated) concentrations approaching 20,000 mg/L.

B.8.2.4 Long-term effects have received less attention than acute impacts. Nimmo et al. (1982) examined the long-term effects of suspended particulates on survival and reproduction of a mysid shrimp (*Mysidopsis bahia*). Average suspended sediment concentrations were maintained at three levels (45, 230, and 1,000 mg/L) for durations up to 28 days, sufficient time for the mysids to complete an entire life cycle. No significant effects were observed on adults within 4 days. After 28 days, however, test mysid populations were reduced to 75% of controls. Nimmo et al. (1982) observed reduced numbers of juveniles produced and increased mortality of the original adult mysids with time, and speculated that suspended sediments interfered with feeding and mating behavior, clogged gill surfaces, and led to disorientation in water currents. The authors concluded that continuous long-term production of suspended particulates in excess of 1,000 mg/L could reduce populations of either planktonic or nektonic organisms in estuaries.

B.8.2.5 Shellfish species inhabiting turbid estuaries and coastal waters can be expected to be adapted to and highly tolerant of naturally elevated suspended sediment concentrations for reasonable durations of time. Long-term operations (months), however, may present problems in



spawning and/or nursery habitats. Otherwise, there is little reason to suspect that shellfishes cannot tolerate the suspended sediment levels typical of most dredging or placement operations.

### B.8.3 Sedimentation.

B.8.3.1 Although various coastal invertebrates exemplify a wide range of reproductive strategies, a large number of representative species produce planktonic egg and larval stages. Relatively few commercially important shellfish species (for example, certain gastropods such as whelks that employ egg cases) deposit eggs on or attach eggs to bottom sediments or hard substrates. Therefore, a concern for potential smothering effects resulting from increased sedimentation rates is less prevalent for shellfish eggs in contrast with demersal fish eggs. Certain egg and larval stages, in particular those of neutral or negative buoyancy which are subject to passive dispersal by water currents, may settle to the bottom and be smothered in project areas characterized by slack- or slow-water flows. Hence, sedimentation effects could become a factor for some species under certain site-specific circumstances.

B.8.3.2 Juveniles of shellfishes that assume sessile (such as oyster spat) or burrowing (such as surf clam) modes of existence may be particularly vulnerable to increased sedimentation rates in the vicinity of dredging operations. Rose (1973) and Saila, Pratt, and Polgar (1972) reported significant mortality of oysters and mussels around dredging and placement operations, respectively, when deposited material remained in place for some time. Wilson (1950) and Ingle (1952), however, reported little apparent detrimental impact on oysters around dredging operations in situations where settled material was dissipated by currents. Ability to maintain depth position within the sediments and to remove accumulated sediments from burrows varies among species. Sedimentation rates induced by dredging operations, however, are generally no higher than those resulting from storm events and may be subsequently removed by currents. Sedimentation rates induced by placement operations, on the other hand, may be such that burial is a concern.

B.8.3.3 Relative organism size influences whether burial will occur. Although meiofaunal organisms such as nematodes and harpacticoid copepods are relatively mobile, they may be more affected by sedimentation than larger, less mobile macrofauna simply based on scale.

B.8.3.4 In addition to smothering effects, increased sedimentation could manifest itself in other ways. Frequent repositioning to maintain a relative distance to the sediment-water interface requires that a shellfish shift its energetic allotments away from other functions such as growth or reproduction. Trueman and Foster-Smith (1976) have suggested that the energetic costs of burrowing can be quite large. In a similar vein, shellfishes such as infaunal shrimps that maintain extensive burrow systems, often with multiple surface openings, need to increase maintenance operations to prevent infilling.

B.8.3.5 The ability of certain benthic organisms to burrow through varying amounts of overburden has been well documented (Glude 1954; Maurer 1967; Shulenberger 1970; Westley et al. 1973; Diaz and Boesch 1977; Chang and Levings 1978; Stanley and DeWitt 1983; Maurer et al. 1986). In most of these cases, the organisms studied were capable of moving up through as much as 10-30 cm (4-12 in.) of material without significant mortality. Factors such as particle size and the rate of sediment deposition must, however, be considered. The long-term effects of rapid

sedimentation episodes are not well understood. As noted by Diaz and Boesch (1977), low-density fluid muds produced from fine-grained material can present severe problems for benthic organisms. This type of material is highly unstable, provides little physical support, and has a low oxygen concentration, which hinders respiration and feeding.

B.8.3.6 An additional concern involves the possible hindrance of settling by oyster larvae on hard surfaces covered by silt. Galtsoff (1964) suggested that as little as 1-2 mm (.04-.08 in.) of silt may be sufficient to prevent settling on shell cultch. As pointed out by Carriker (1986), however, the fact that larvae can attach to surfaces fouled by mucoid films, microbes, and detritus suggests that oyster larvae are indeed capable of dealing with relatively unclean surfaces.

B.8.3.7 Sessile or sedentary species are most vulnerable to adverse impacts, the most obvious of which are burial and smothering of organisms. This is especially important in waters characterized by slack-water or low-flow conditions where high sedimentation rates occur following suspension of sediments by dredging/placement activities. Organisms that are sessile will simply be buried in situ at high sedimentation rates, but mobile and active burrowing organisms may also be affected when sedimentation rates are sufficiently high to result in burial, as may occur during placement operations. Concern may also be warranted when low-density fluid muds are involved.

#### B.8.4 Entrainment.

B.8.4.1 Both demersal and pelagic eggs, larvae, and juveniles of shellfishes are susceptible to entrainment by suction dredges due to their inability to escape the suction field around the intake pipe. Demersal forms may be picked up directly with the sediment, while pelagic forms may be drawn in from the surrounding water column. With regard to the Dungeness crabs (*Cancer magister*), which should be considered mobile, Tegelberg and Arthur (1977) reported no apparent avoidance of a dredge by crabs resting, partially buried, in the bottom sediments. Direct study of entrainment of shellfishes is limited to the Dungeness crab (Tegelberg and Arthur 1977; Stevens 1981; Armstrong, Stevens, and Hoeman 1982) and the sand shrimp, *Crangon* spp. (Armstrong, Stevens, and Hoeman 1982), both of which were studied in Grays Harbor, WA. The only other consideration of entrainment involved a workshop on the potential for entrainment of larval oysters (American Malacological Union 1986), discussed at the end of this section.

B.8.4.2 Entrainment rates for Dungeness crabs and sand shrimp by clamshell, hopper, and pipeline dredges are summarized in Table B-11. Rates of entrainment of Dungeness crab ranged from 0.035 to 0.502 crab/yd<sup>3</sup> and were lowest for clamshell dredges followed by pipeline and hopper dredges. Overall mortality of those organisms entrained was highest for pipeline dredges (100%) versus hopper dredges (56 to 73%) (Stevens 1981; Armstrong, Stevens, and Hoeman 1982), given differences in delayed mortality. In the case of clamshell dredges, mortality is restricted to potential burial and abrasion during transport or deposition of dredged material while suction dredges may impart additional damage from the suction mechanisms and, in the case of hopper dredges, the splash plates used to disperse material within the hopper. The 100% mortality rate reported for crabs entrained by pipeline dredges reflects the entrainment of crabs.

B.8.4.3 Both Stevens (1981) and Armstrong, Stevens, and Hoeman (1982) observed lower overall mortality (45.9% versus 85.6%) for small crabs (<50-mm carapace width) with that of

large crabs (50-mm carapace width). Small crabs are apparently less susceptible to physical damage due to their size. Stevens (1981) estimated a potential overall mortality rate of 0.1 crab/ yd<sup>3</sup> for a typical dredging year in Grays Harbor, or about 100,000 crabs per year. Armstrong, Stevens, and Hoeman (1982) estimated a year-round figure for Grays Harbor of 2.6-3.5 million crabs and a restricted winter-only dredging figure of 2 million crabs (a reduction of 44%). In both cases entrainment was correlated with crab abundance. Both studies also suggested that restrictions be imposed on dredging during the summer months (March-August), when crabs were most numerous. Entrainment rates of sand shrimp were up to six times greater than the highest rates reported for Dungeness crab (Table B-10); however, these rates were observed during the summer months (May-August) when shrimp were most abundant. Ghost shrimp (*Callinassa californiensis*) were also reported to be entrained at a rate of 0.727 shrimp/ yd<sup>3</sup>, but for only one area of Grays Harbor. While these rates seem insignificant taken alone, they become more meaningful when used to predict the total impact on a given population in a particular area, as was done for Dungeness crab in Grays Harbor. Reine, Dickerson, and Clarke (1998) summarize existing literature regarding potential impacts to aquatic organisms caused by entrainment during dredging operations.

Table B-11. Entrainment Rates Reported for Three Dredge Types in Grays Harbor, WA

Dredge Type	Rate <sup>1</sup>	Reference
<i>Cancer magister</i>		
Clamshell	0.012	Stevens (1981)
Hopper	0.131-0.327	Tegelberg and Arthur (1977)
	0.182-0.231	Stevens (1981)
	0.055-0.518	Armstrong, Stevens, and Hoeman (1982)
Pipeline	0.0017-0.241	Stevens (1981)
	0.015-0.200	Armstrong, Stevens, and Hoeman (1982)
<i>Crangon spp</i>		
Hopper	0.063-3.375	Armstrong, Stevens, and Hoeman (1982)
Pipeline	0.001-3.404	Armstrong, Stevens, and Hoeman (1982)

<sup>1</sup> Number of organisms per cubic yard dredged

B.8.4.4 In addition to direct entrainment, Armstrong, Stevens, and Hoeman (1982) also speculated on the indirect impacts of dredging on crabs as well as on other organisms. These impacts include direct removal of food sources for crabs, shrimps, and fishes; alteration of intra-specific competition; burial of crabs; and toxicant release from suspended sediments.

B.8.4.5 The potential for entrainment of larval oysters by hydraulic cutterhead dredges was addressed by a workshop sponsored and conducted by the U.S. Army Engineer District, Baltimore, and the U.S. Army Engineer Waterways Experiment Station (WES) (American Malacological Union 1986). Participants in this workshop reported on state-of-the-art knowledge about oyster distribution and biology and the physicochemical effects of hydraulic dredging operations that could potentially affect oyster larvae. The goal of the workshop was to determine if this information could be used to help predict whether entrainment of larval oysters would be problematic. From this exercise, a model of entrainment was proposed that predicted dredge-

induced mortality at rates between 0.005 and 0.3% of late-stage larvae (Carriker et al. 1986); thus, minimal impact would be expected. However, concern over entrainment would be justified under certain site-specific conditions, such as dredging within a narrow channel or other restrictive water body. A contrasting view of the extent of entrainment of oyster larvae was presented by Carter (1986), who predicted that larval survival (all stages) would be reduced by 12-51% through dredge-induced mortality. Both models are based on a somewhat different set of assumptions about larval biology, and both remain untested.

B.8.4.6 The potential for entrainment is increased in restricted bodies of water, such as narrow channels, where mobile organisms may not be able to avoid the dredge or where more passive organisms may be concentrated. The importance of site-specific conditions in project areas is readily apparent and should be the foremost consideration in planning and scheduling dredging/placement operations.

## B.9 Effects of Environmental Alterations on Benthic Assemblages.

### B.9.1 Introduction.

B.9.1.1 Benthic communities, as discussed here, compose a general category including both hard- and soft-bottom assemblages (such as mollusc beds, grass beds, and coral reefs). Kendall (1983) provides an excellent review of the role of physical-chemical factors in structuring sub-tidal marine and estuarine benthos. Effects on fish and shellfish spawning grounds have been discussed in previous sections. In addition to direct disturbance through removal, sedimentation, and chemical contamination, concerns have also been raised about recovery of the given assemblage after disturbance and the relative resource value of the resulting assemblage compared with what previously existed. The difficulties encountered in seeking answers to these questions reflect the limited understanding of how organisms in these habitats are adapted to often highly variable environmental conditions.

B.9.1.2 A number of studies (Loucks 1970; Holling 1973; Orians 1974; Oliver et al. 1977; Sutherland 1981; Newell, Seiderer, and Hitchcock 1998) point to a positive relationship between community resilience (rate of recovery from disturbance) and environmental and community variability (such as higher variability and faster rate of recovery). To a larger degree, this relationship reflects the life history characteristics of the organisms inhabiting a given area and, to a lesser degree, chance. Both factors are themselves related. Consideration should also be given to the dredging/placement-induced physical changes to the habitat (such as alteration of grain size, slope, and compaction) and how these parameters can affect the nature of the resultant community. This is a particularly important concern relative to beach nourishment projects (Naqvi and Pullen 1982; Nelson and Pullen 1985). Timing of disturbance is also quite important since many benthic species have distinct peak periods of reproduction and recruitment. Recovery of a community disturbed after peak recruitment, therefore, will be slower than that of one disturbed prior to peak recruitment. A general consensus among researchers reporting on effects of dredged material placement (Boone, Granat, and Farrell 1978; Tatem and Johnson 1978; Wright, Mathis, and Brannon 1978) is that impacts on benthic communities are primarily physical (for example, burial) and not chemical (for example, bioaccumulation).

B.9.1.3 Benthic assemblages of estuarine muds and sands generally require from 3 months to 1 year to recover after placement of maintenance dredged material. McCauley, Parr, and Hancock (1977) monitored infaunal populations immediately before and after dredging and dredged material placement in a muddy mesohaline (15-20 ppt) portion of Coos Bay, OR, and reported that predredging densities were achieved within a month of placement. Van Dolah et al. (1979) found that 6 months were necessary for muddy euhaline (30 ppt) communities in Sewee Bay, SC, to return to preplacement conditions. The same recovery period has been reported by Leathem et al. (1973) after dredged material placement on sandy bottoms in the Delaware Bay. Van Dolah, Calder, and Knott (1984) also studied dredging and open-water disposal impacts at a sandy site within the Dawho-North Edisto River system, SC, and reported recovery within 3 months. Clarke and Miller-Way (1992) have reported infaunal recovery within a year for a muddy oligohaline reach of the Mobile Bay. Flemer et al. (1967) reported that natural disturbances were more important in structuring infauna at Louisiana dredged material placement areas than placement events.

#### B.9.2 Suspended sediment/sedimentation.

B.9.2.1 The effect of burial of benthic organisms largely depends on the ability of organisms to migrate upward through the overlying deposits. In the case of sedentary species (such as oysters and coral reef organisms), relatively small quantities of silt may be enough to cause high rates of mortality, especially in coral reef organisms that are highly intolerant of silt. Saila, Pratt, and Polgar (1972) and Rose (1973) reported mortality of oysters and mussels from direct burial associated with placement and dredging operations, respectively. Wilson (1950) and Ingle (1952), however, reported no apparent impact to oysters around dredging operations in situations where settled material was dissipated by currents. In addition to quantity of material, the physical properties or quality of the material may also be an important consideration. As noted by Diaz and Boesch (1977), low-density fluid muds produced from placement of fine-grained materials presented immediate problems for benthic organisms; however, recovery did occur within a few months. This type of material is characterized by instability and low oxygen concentration, which provides little physical support for organisms, hinders respiration, and inhibits feeding. In the case of beach nourishment projects, the type of material deposited (sand, silt, clay) and its physical characteristics can have important consequences to the organisms being covered and controls the assemblage that will subsequently develop there (Naqvi and Pullen 1982; Reilly and Bellis 1983; Nelson and Pullen 1985).

B.9.2.2 In addition to direct smothering and/or burial, suspended sediments and/or a blanket of silt can affect organisms by hindering their settlement on hard substrates and by screening out incoming light. In the case of oyster larvae, a layer of silt only 1 to 2 mm (.04-0.08 in.) thick can physically hinder the attachment of settling larvae. In addition, sediment particles may act to hinder or block attractive chemical cues on hard substrates or waterborne pheromones (Crisp 1967; Hidu 1969), as noted previously, thereby preventing attachment. It is likely that silt may affect a number of organisms in this way. Carrier (1986) points out that oyster larvae are indeed capable of dealing with relatively unclean surfaces.

B.9.2.3 Light attenuation may be either detrimental or beneficial depending on the organism. In the case of submersed plants, high turbidity or a deposit of silt on leaf blades has the potential to reduce photosynthetic activity substantially although quantitative estimates have

not been determined (Zieman 1982; Thayer, Kenworthy, and Fonseca 1984). Similarly reduced light levels over coral reefs can affect growth of symbiotic algae (*zooxanthellae*) (Courtenay et al. 1972; Bak 1978). However, in the case of oyster larvae, reduced light levels may act to simulate the shaded conditions on the underside of shell material, the preferred settling site (Ritchie and Menzel 1969). These authors point out that the effect would be increased settling of the late-stage larvae. Another possible effect of a turbidity screen would be the protection of gametes and larvae from the detrimental effects of ultraviolet radiation near the surface (Wilber 1971). As pointed out by Carriker (1986), however, these and other effects of suspended sediment and silt, although interesting possibilities, remain unstudied.

B.9.2.4 A high rate of sedimentation, particularly for placement operations, is an obvious concern because of the potential for burial of benthic communities. Sedentary organisms (for example, reef-forming molluscs, submersed plants, and coral reefs) are particularly vulnerable to burial. Less severe but potentially damaging films of silt or suspended sediment plumes may affect feeding, respiration, or photosynthetic activity.

### B.9.3 Bottom disturbance/recolonization.

B.9.3.1 Whether a benthic assemblage is destroyed by a dredging operation or is buried by sediment, concerns are raised about the significance of the loss as it relates to organisms that depend on this resource for food. Benthic organisms are important food sources for a host of demersal fishes and shellfishes of all stages (juvenile-adult). At present, however, little is known about how much production a given benthic community can support, and even less is known about the relative importance of different types of assemblages (for example, vegetated versus nonvegetated and early versus late successional stage) to production. Major points of contention in this debate are questions about rates of recovery of benthic assemblages after impact and the relative importance of early versus late successional stages of the postimpact community as forage for fishery resources. Studies conducted by Flemer et al. (1967) on macrobenthic community colonization and community development in dredged material placement habitats off the Louisiana coast suggest that frequent natural disturbances can explain differences in macrobenthic animal community structure more than the effects of dredged material placement.

B.9.3.2 Newell, Seiderer, and Hitchcock (1998) present a review that provides “a framework within which the impact of dredging on biological resources that live on the sea bed (benthic communities) can be understood, and places in perspective some of the recent studies that have been carried out in relation to aggregates dredging in European coastal waters.” The impact of dredging works on fisheries and fish themselves, and on their spawning grounds is outside the scope of this review.

B.9.3.3 Recovery rates of macrobenthic assemblages following both dredging and placement operations generally range from only a few weeks or months to as much as a few years, depending on the type of project (dredging or placement), the nature of the bottom, physical characteristics of the environment, and the timing of disturbance. Most placement operations result in initial smothering of organisms, followed by rapid recovery within weeks or months (Pfitzenmeyer 1970; Saila, Pratt, and Polgar 1972; Leathem et al. 1973; Maurer et al. 1974; Oliver et al. 1977; Bingham 1978; Boone, Granat, and Farrell 1978; Tatem and Johnson 1978; Wright, Mathis, and Brannon 1978; Bokuniewicz and Gordon 1980, Newell, Seiderer, and

Hitchcock 1998). Other studies have reported minimal or no impact on macrofaunal assemblages under conditions of high current flows that acted to dissipate suspended materials (Van Dolah et al. 1979; Van Dolah, Calder, and Knott 1984; LaSalle and Sims 1989). Similar short-term recovery rates, following natural defaunation events (such as storms and anoxia), have also been reported (Saloman and Naughton 1977; Simon and Dauer 1977). Meiobenthic assemblages, on the other hand, have been reported to have very low rates (years) of recovery (Rogers and Darnell 1973; Pequegnat 1975; Rogers 1976). For reviews of impacts from beach nourishment, see Naqvi and Pullen (1982) and Nelson and Pullen (1985). Literature reviews by Nelson (1985, 1993) and Hackney et al. (1996) indicate that recovery times for beach infauna after renourishment range from 2 to 7 months. Saloman and Naughton (1984) reported infaunal recovery within 5-6 weeks for a Florida beach while studies in South Carolina by Van Dolah, Calder, and Knott (1984) and Jutte, Van Dolah, and Levisen (1999a, 1999b) have reported recovery periods ranging from 3 to 6 months. The longest recovery times (1-1.5 years) have been reported for beaches where the silt/clay content of nourishment materials exceeded those of natural beach sediments (Reilly and Bellis 1983; Rakocinski et al. 1996)

B.9.3.4 In the case of maintenance dredging operations, minor impacts have been reported (Stickney and Perlmutter 1975; McCauley, Parr, and Hancock 1977) while for shell dredging, initial reduction in benthic abundance was followed by rapid recovery (Harper 1973). Dredging of new channels, however, may result in drastic and long-term (years) changes in nearby macrofaunal assemblages (Taylor and Saloman 1968; Kaplan, Welker, and Kraus 1974), in part due to changes in the hydrologic regime and potential alteration in salinity patterns.

B.9.3.5 A number of studies (Loucks 1970; Holling 1973; Orians 1974; Oliver et al. 1977; Sutherland 1981; Newell, Seiderer, and Hitchcock 1998) point to a positive relationship between community resilience (rate of recovery) and environmental variability—communities inhabiting highly variable habitats have higher rates of recovery. To a large degree, this relationship is related to the life history characteristics of the organisms composing the assemblage and the timing of the disturbance (Rhoads, McCall, and Yingst 1978; Rhoads and Boyer 1982; Newell, Seiderer, and Hitchcock. 1998). High reproduction and turnover rates and high dispersal ability allow opportunistic species to colonize newly exposed material very rapidly and, in fact, these abilities allow these species to inhabit highly variable environments. Timing of disturbance is also quite important since many benthic species have distinct peak periods of reproduction and recruitment.

B.9.3.6 The nature of the assemblage in terms of species composition also varies depending on both the availability of species in adjacent areas and, to some degree, chance events. Pearson (1975) describes two stable benthic assemblages that develop after an oxygen depletion event (induced by organic enrichment) defaunates the bottom. Initial colonization of either assemblage is largely a chance event. Each assemblage is composed of two or three dominant species. Once such an assemblage colonizes the bottom, it is capable of blocking establishment of the second. A general pattern of marine succession, as proposed by Rhoads, McCall, and Yingst (1978), entails a deterministic progression of colonizers governed by facilitation (each assemblage in the succession enhances the development of the next). Homziak (1985), however, describes estuarine succession as a stochastic process governed more by the availability and composition of colonists, which are, to a large degree, chance events. Brenchley (1981) points to the

importance of the ability of certain species to affect colonization by other species. She suggests that physical events, such as bioturbation of the sediment (for example, burrowing activity), act to control community structure and may be more important than the previously implied importance of key species (for example, keystone predators) in certain trophic levels.

B.9.3.7 Predicting a rate of recovery and the nature (composition) of the resultant assemblage is not always possible. In general, however, comparisons of the nature of early- versus late-stage species composing assemblages can be made and related to their value as a food resource for other species (Rhoads, McCall, and Yingst 1978). Early colonists tend to be opportunistic species characterized by small size, rapid growth, short life span, and high rates of turnover and reproduction. These species are readily attracted to newly available sources of organic carbon, which usually characterize newly disturbed sediments. These organisms inhabit the surface layers of the bottom and are readily available to epibenthic and demersal predators. By comparison, later arriving species are characterized by larger size, slower growth, longer life span, and slower rates of turnover and reproduction. These species live at greater depths in the sediment and are, therefore, less readily available to predators (for details, see Rhoads, McCall, and Yingst 1978, and Rhoads and Boyer 1982). From this comparison, it can be predicted that—from a fisheries standpoint—early-stage assemblages may be of higher value by virtue of high production and availability.

B.9.3.8 To evaluate the relative value of such bottom assemblages to fisheries production, the Benthic Resources Assessment Technique was developed by the Environmental Laboratory, U.S. Army Engineer Waterways Experiment Station (now the U.S. Army Engineer Research and Development Center) (Clarke and Lunz 1985). Application of the technique by Lunz (1986) has shown that early successional assemblages, established on dredged material placement sites, have higher fisheries value in terms of available biomass and higher potential usage by benthic feeding fishes (particularly juveniles) than nearby reference areas. In effect, disturbance by dredged material placement (burial of the preexisting assemblage) serves to reset the progression of the assemblage along a successional gradient, as would occur naturally following storm events. These observations, however, should not be misinterpreted as suggesting that early-successional assemblages are “better” and/or “of higher value” in terms of all functional parameters than late-stage assemblages. For example, late-successional stages do serve other equally important functions in sediment processes, such as organic matter turnover and aeration.

B.9.3.9 Given the highly variable nature of most estuarine and marine benthic assemblages, disturbances by dredging/placement activities usually represent relatively minor and short-lived impacts, similar to those induced by storm events, oxygen depletion events (natural or industrially induced), and other disturbances. Some concern, however, may be warranted in cases when the areal extent of impacted bottom represents a large proportion of the parent body of water. In that event, some consideration should be given to the characteristics of the habitat itself (for example, highly variable versus relatively stable) and the relative condition of the unimpacted area, given its potential value to the overall ecosystem. When possible, consideration should also be given to scheduling activities before peak periods of recruitment by the benthic fauna. This would help decrease the recovery time for the assemblage.



B.10 Effects of Environmental Alterations on Endangered Species, Sea Turtles, Marine Mammals, and Colonial-Nesting Birds. Issues involving endangered species are based largely on concerns about disturbances to critical physical habitat and/or noise interruptions of nesting/breeding activities. In the case of the latter, seasonal restrictions applied to dredging/placement operations are common (see Table 2-18 and Chapter 5, “Beneficial Uses of Dredged Material”) and, in many cases, criteria concerning a buffer zone around a site are designated. Operations are permitted outside this zone. Similarly, issues involving sea turtles, marine mammals, and colonial-nesting birds largely concern disturbance of nesting areas, either directly through physical alteration or indirectly through noise disturbance in proximity to a nesting/breeding site. In the case of colonial-nesting bird sites, particularly those on dredged material placement sites, concerns include either periodic placement of new dredged material on the island or noise disturbance by dredging/placement operations in the immediate vicinity of a colony. In addition to these habitat-related issues, the issues of interference with movement (for example, channel blockage) of marine mammals in restricted areas and the potential entrainment of sea turtles in channel areas have also been raised.

#### B.10.1 Noise disturbance.

B.10.1.1 Human activities near the nesting sites of any animal have the potential to disrupt behavior, which may lead to lowered hatching success or nest abandonment. In the case of some colonial-nesting birds, noise disturbances may lead to adult birds leaving the nest, which may affect the eggs or young chicks in a number of ways. Nervous adult birds may accidentally crush or knock eggs or young out of nests. Prolonged absence of an incubating adult bird may effectively increase incubation time and may increase exposure of eggs or young chicks to the environment and predators. Additionally, activities in the vicinity of colonies or feeding grounds may affect the birds’ ability to gather food for themselves and their chicks.

B.10.1.2 It has been suggested that dredging/placement activities on or in the vicinity of dredged material islands, as well as other colonial-nesting bird colonies, be restricted to non-breeding seasons to avoid disturbances to the birds (Landin 1986a). Activities may be allowable outside a buffer zone (about 100 m [300 ft]) around the nesting site.

#### B.10.2 Chemical release.

B.10.2.1 Concern is always warranted when dealing with sediments known to be contaminated with heavy metals, hydrocarbons, or other potentially toxic compounds. The possibility exists that contaminants, released by sediment suspension, may adversely affect organisms in a number of ways. Contaminants may become adsorbed onto eggs and ingested or absorbed by larval, juvenile, or adult forms (Cairns 1968). Organisms may bioaccumulate contaminants through feeding (Chen et al. 1976; Nathans and Bechtel 1977; Burks and Engler 1978; Neff, Foster, and Slowey 1978; Kay 1984; Rubinstein, Gilliam, and Gregory 1984). It appears, however, that soluble fractions of most compounds have greater effects than sediment-sorbed fractions. Evidence also suggests that many contaminants may lower the threshold concentration of suspended sediments at which detrimental effects on survival and development of eggs and larvae are produced. These effects may take the form of altered morphology, physiology, behavior, and/or pathology in fish (Sindermann et al. 1982) and shellfish (Tagatz 1976; Farr 1977, 1978). For example, the exposure of the grass shrimp *Palaemonetes vulgaris* to sublethal

31 Jul 15

concentrations of mirex (Tagatz 1976) and *Palaemonetes pugio* to sublethal concentrations of parathion and methyl parathion (Farr 1977, 1978) impaired both species' antipredatory behavior to predatory fishes, resulting in increased mortality in controlled experiments.

B.10.2.2 In general, water-soluble fractions of compounds have a greater effect on organisms than sediment-sorbed fractions. In addition, toxicity is more pronounced under conditions of low salinity and high temperature. The enormous diversity of chemical compounds and possible synergistic effects further complicates the issue. Good general reviews of the literature on the availability and bioaccumulation of heavy metals, petroleum hydrocarbons, synthetic organic compounds, and radionuclides contained in sediments are provided by Kay (1984) and Olsen (1984). More specific information on the toxicity, sublethal effects, and bioaccumulation of selected chemical compounds on various organisms is given by Eisler (1985a, 1985b, 1985c, 1985d, 1986a, 1986b, 1986c, 1986d, 1987a, 1987b, 1988a, 1988b, 1988c) and Eisler and Jacknow (1985).

B.10.2.3 In light of these concerns, existing regulatory guidelines for the management of contaminated sediments (USEPA/USACE 1991, USEPA/USACE 1998) should be consulted whenever dredging activities involve such sediments.

#### B.10.3 Dissolved oxygen reduction.

B.10.3.1 The reduction of DO to levels below 1-2 ppm has the potential to affect non-mobile organisms or life history stages (for example, demersal eggs) in the vicinity of a dredging and/or placement operation. Morrison (1971) reported that the eggs of the hard clam, *Mercenaria mercenaria*, were tolerant of oxygen concentrations as low as 0.5 ppm, with death occurring only at 0.2 ppm. Available information suggests that, in typical dredging/placement operations, reductions in DO are restricted to the bottom waters (in fluid mud) and are short-term phenomena (on the order of hours). Sediments having a high organic content and those affected by organic loading (such as sewage sludge) may, however, cause significant reductions in DO (Brown and Clark 1968) for longer periods of time. As with sedimentation, mobile juvenile and adult organisms are capable of avoiding localized areas of low oxygen content.

B.10.3.2 The apparent relationship between suspended sediment concentration and levels of DO leads to recommendations similar to those presented earlier for suspended sediments. Given the levels of suspended sediment and associated short-term reductions in DO around typical dredging/placement operations, impacts should be minimal. Detrimental effects on demersal eggs and larvae would not be expected except in cases of long-term placement operations when DO levels are kept low for extended periods.

#### B.10.4 Channel blockage.

B.10.4.1 Channel blockage, by the physical presence of the dredging/placement equipment or by the suspended sediment plume, is suspected to have an effect on the distribution and movement of juvenile and adult organisms, particularly anadromous fishes, turtles, and some marine mammals. In the case of fishes and shellfishes, the only available information on the subject consists of a few observations of the attraction of fishes and shellfishes to dredging

operations (Ingle 1952; Viosca 1958; Maragos et al. 1977) and a report of trawl data taken in a dredge placement plume versus “clear” ambient water (Harper 1973).

B.10.4.2 In the case of fishes, the average number collected in clear water was quite similar in summer and winter; the average number of individuals in turbid plume waters was much larger in winter (Harper 1973). Only one species (bay anchovy, *Anchoa mitchelli*) showed a pronounced tendency to avoid the plume during the summer while another (Gulf menhaden, *Brevoortia patronus*) showed a preference for clear water in summer and winter. Additional comparisons of fish abundances in naturally turbid versus clear water showed that the average number of individuals and fish biomass values were higher in the turbid water during the winter but were similar during the summer. *Brevoortia patronus*, previously shown to avoid the dredge plume, was collected only in turbid waters and at high densities, suggesting that some factor other than sediment suspension may have been a factor.

B.10.4.3 In the case of shellfishes, the blue crab, *Callinectes sapidus*, was collected in equal numbers in both clear and turbid waters during the summer, but it was collected in much larger numbers in turbid waters during the winter (Harper 1973). Brown shrimp, *Penaeus aztecus*, and grass shrimp, *Palaemonetes pugio*, showed a preference for turbid water, but they were common components of the samples in only one season. White shrimp, *Penaeus setiferus*, seemed to have no preference for either clear or turbid water.

B.10.4.4 Little information is available on vertical movements of fishes or shellfishes in response to turbidity/light availability. Dadswell, Melvin, and Williams (1983) observed a direct relationship between turbidity in the water column and the density of American shad (*Alosa sapidissima*) in an offshore open-water situation. In this case, the fish may have been responding to ambient light levels and not directly to turbidity.

B.10.4.5 In the case of sea turtles and marine mammals, concerns are based on the potential for dredging/placement equipment to directly interfere with these organisms in narrow or confined channel areas. Sea turtles are suspected of hibernating in some deep navigational channels (for example, Cape Canaveral, FL) during the winter (Carr, Ogren, and Moven 1980) where they may be entrained by dredges operating in these channels. Dredges operating in borrow areas in the vicinity of beach nourishment operations may also entrain young nestlings (sea turtles) coming from nearby beaches. In the case of manatees, the potential exists for dredges, barges, or support craft to directly collide with individuals or block the movement of individuals in narrow channel areas.

B.10.4.6 Consideration of project area morphology should be made relative to potential inhibition of movement of juvenile and adult fishes and shellfishes. Restrictions may be justified in cases where the turbidity plume generated by an operation extends across the entire waterway or channel. Given the supposition that sea turtles hibernate in some deep channel areas (Carr, Ogren, and Moven 1980) during winter, concern about potential entrainment seems justified and should be considered. Careful planning and caution during dredging operations can also minimize any impacts to turtles or mammals in channel areas.

EM 1110-2-5025  
31 Jul 15

THIS PAGE INTENTIONALLY LEFT BLANK

## APPENDIX C

## Confined Aquatic Disposal

C.1 Background.

C.1.1 Confined aquatic disposal (CAD) (placement) is the dredging of unacceptable contaminated sediments from one or more locations, transporting of the material to a placement site, and controlled capping or covering of contaminated material in open water (Shaw, Whiteside, and Ng 1998). Unacceptable sediments are those that have potential detrimental effects to the environment and human health and are not suitable for unrestricted open-water disposal (Palermo 2002). Examples of sediment contaminants are polycyclic aromatic hydrocarbons, polychlorinated biphenyls, and heavy metals (Morris and Fredette 2002). Caps usually involve the use of some type of relatively uncontaminated (acceptable) material to prevent lateral and vertical spreading (physical, chemical, and biological isolation) (Moore, Spadaro, and Degens 2002) of the contaminated material. A conceptual illustration of a CAD pit is found in Figure C-1. The objective of the cap is minimal future loss and environmental impact of the contaminated material, which is often silty, fine-grained sediments (Fredette et al. 2000).

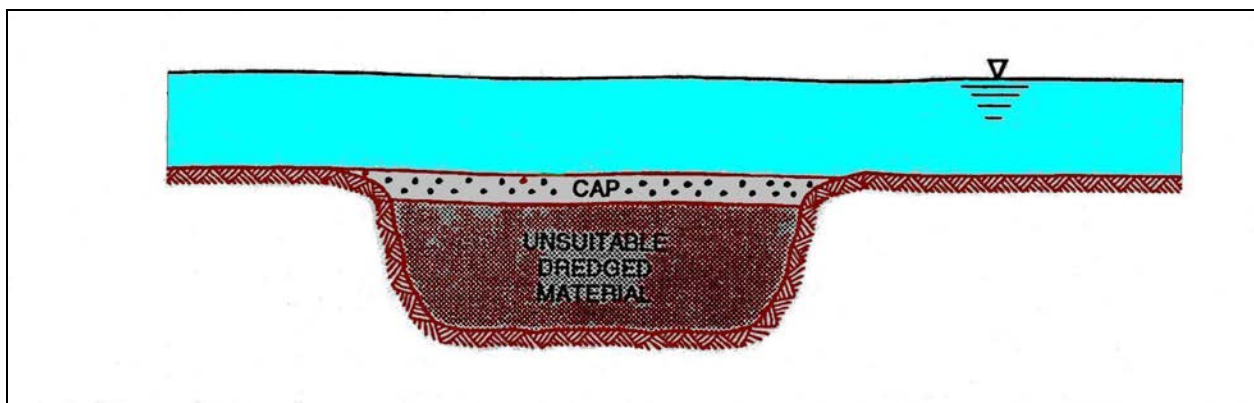

Figure C-1. Conceptual Illustration of a Confined Aquatic Disposal (CAD) Pit (Palermo 1999)

C.1.2 Contaminated sediments unsuitable for conventional placement may be confined, contained, treated, or simply not dredged. CAD pits (cells) offer both practical and effective management of contaminated sediments and have been successfully used in many locations since the 1970s. Long-term effectiveness, water depth, and exposure to high-energy environments are issues that should be investigated during the planning of CAD pits (Nilson, Hadden, and Giard 1998).

C.1.3 CAD pit construction has several advantages over other placement options (for example, artificial islands and decontamination) (Fredette et al. 2000), including the following:

- a. Construction in a relatively short period of time.
- b. Construction on an as-needed basis.
- c. Logistical efficiency.

- d. Minimal equipment needs.
- e. Location near dredging sites.

C.1.4 CAD pits may be naturally occurring depressions or newly constructed subaqueous pits. (Palermo, Ebersole, and Peyman-Dove 1998).

C.1.5 Advantages (Headland et al. 2002) of CAD pits include the following:

- a. Construction with conventional dredging equipment.
- b. Chemical and biological environment unchanged.
- c. Relatively low cost solutions.

C.1.6 Disadvantages of CAD pits include the following:

- a. Possible loss of contaminated sediments during transport and placement.
- b. Locating potential placement sites.
- c. Obtaining approval of permitting agencies.

C.1.7 The following permits and regulations (Pembroke et al. 1998) must be considered:

- a. Section 10 of the Rivers and Harbors Act.
- b. Section 404 of the Clean Water Act.
- c. Section 103 of the Marine Protection, Research, and Sanctuaries Act (MPRSA).
- d. National Environmental Policy Act.
- e. Council on Environmental Quality.
- f. Local and/or state regulations concerning navigation.
- g. United States Coast Guard Navigation requirements.

C.2 Site Selection and Evaluation. The key environmental issue with any dredging project is how and where to place the dredged material. Difficulty in location of placement sites increases with the volume and quality of the sediments to be dredged. The following factors should be considered for CAD pit placements.

C.2.1 Engineering requirements. The sizing of the pits will depend upon the volume, excavated depth and surface area exposure (Shaw, Whiteside, and Ng 1999). Depths of pits may vary between 1.2 and 12 m (4 and 40 ft). Horizontal dimensions may also have great variation, with some pits as wide as 457 m (1,500 ft) and as long as 1,524 m (5,000 ft). Pits that have widths less than 152 m (500 ft) and lengths less than 610 m (2,000 ft) show significant lessening

of sediment retention efficiency. Large pits with an aspect ratio (length to width) between 3 and 4 have been found to be highly desirable. Most CAD sites are constructed on sites with bottom slopes less than 6%. Bathymetric surveys will be required to determine suitable locations (Palermo, Ebersole, and Peyman-Dove 1998). The higher the bottom slope, the less desirable the site for CAD pits. Generally, sites with slopes greater than 5% are excluded. Filling may occur incrementally with the initial placement being capped before the entire pit is filled. The cost of a CAD site depends directly upon the volume of material dredged and placed. Bulking should also be considered since the volume of dredged material may be altered due to sediment disturbance and increased water content (Fredette et al. 2000). The size of the pit depends on the volume to be contained, the estimated bulking, and the volume needed for the cap. Another important consideration is the surface area exposure of the CAD pit and potential losses of sediment due to turbulent water conditions (tide, current, and storm effects). Submerged sand berms may be constructed around some pits to reduce current velocities and wave activity. Berm construction could reduce the cost of pit material removal, and the pit material might be used for the final capping (Palermo 1999).

C.2.2 Single CAD site versus a series of CAD sites. Several small CAD pits have comparable costs to one large CAD pit because the cost of excavation is a function of the volume dredged. However, several small pits, capped as the work progresses, have the advantage of less exposure of contaminated material prior to capping. Construction of new CAD pits could result in slope failures and in the exposure and resuspension of contaminated material. For example, slope failures that occur during seismic events could potentially release material into the marine environment. If the material from which the excavation is made is comprised of sands, silty sands, or gravels, the slope of the pit usually will be 1V on 3H. If the bottom material is very soft, stable slopes may need to be flatter and should be 1V on 4H (Palermo 1999).

C.2.3 Water depth. Water that is too shallow may cause an access problem for dredging, transport, and placement. While shallow water has the advantage of less dispersion of material during the placement process, deeper water has the advantage of less erosion due to wave action and propeller wash by the passage of large deep-draft vessels (Fredette et al. 1999). However deep water also has the disadvantage that pit preparation and monitoring become problematic. Depths of approximately 37 m (120 ft) are about the practical limit for excavation with conventional dredging equipment, and as water depths increase, the efficiency of the dredging process decreases. The depth to bedrock presents a potential economic constraint related to pit excavation depth (Palermo 1999).

C.2.4 Operational logistics. CAD pits should be located as near as possible to the center of the hauling distances. Increasing the hauling distance directly increases the project costs.

C.2.5 Hydrodynamics. CAD pits in relatively low-energy environments are generally preferable to locations in higher energy areas though site-specific considerations must factor into such decisions (Palermo, Ebersole, and Peyman-Dove 1998). Material in CAD pits may be exposed to current fields, wave action from storms, and storm surges (Puckette 1998). Another consideration of CAD pit location is the possibility of exposure to seasonal floodwaters (Winter 2002).

C.2.6 Sediment characteristics. If a CAD pit must be excavated, one strong consideration is the potential beneficial use of the excavated material. If the excavated material is highly suitable for construction purposes, the site is highly preferable. In contrast, excavated material not suitable for construction purposes make the pit less advantageous, and the excavated material must still be placed (Palermo, Ebersole, and Peyman-Dove 1998).

C.2.7 Water quality/far field contaminant transport. Another factor to be considered in selecting CAD pit placement locations is the possibility of spillage during the placement or resuspension due to extreme storm conditions. Sites with high currents that might take contaminants to bathing beaches, environmentally sensitive areas, or water intakes are undesirable (Hayes, Borrowman, and Welp 2000).

C.2.8 Biological resources. New construction of pits, placement of contaminated material, and placement of caps will result in temporary loss of aquatic habitat (Palermo, Ebersole, and Peyman-Dove 1998). It is assumed that the pit areas will be returned to pre-existing bathymetry after capping. Limited research shows that benthic recolonization over the surface of a cap returned to an equilibrium state approximately 5 years after capping. Areas that provide habitat to threatened or endangered species or that have a high use for commercial fishing or commercial shellfish should be carefully evaluated (Valente and Fredette 2002).

C.2.9 Cultural resources. Areas of known historical/archeological value should be protected from excavation and/or contaminated material placement.

C.2.10 Infrastructure. Areas that include navigation channels, military exclusion zones, bridges, tunnels and pipelines need careful evaluation. However, areas with easy access to navigation channels may be desirable (Palermo, Ebersole, and Peyman-Dove 1998).

C.2.11 Jurisdictional consideration. The political jurisdiction of the CAD areas must be strongly considered. Areas outside of the 19 km (12 mi) limit are in international waters and should not be considered for CAD pits.

C.2.12 Previously impacted areas. Areas previously impacted by dredging placement should receive strong consideration for future sites.

C.2.13 Location of capping material. Usually the capping material is taken from an area near the area requiring the contaminated dredging, and economics become a prime consideration.

C.2.14 Recreational use. The location of CAD pits may cause the temporary loss of recreational boating and fishing areas (Palermo, Ebersole, and Peyman-Dove 1998).

C.2.15 Seismic activity. Preliminary seismic studies should be undertaken in areas of potential CAD pits. CAD pits should not be located within 3 km (2 mi) of known active faults (Palermo, Ebersole, and Peyman-Dove 1998).

C.2.16 Aesthetics. Aesthetics is usually a small consideration in the location of CAD pits. The frequent activity that takes place around a CAD cell may be undesirable near recreational beaches (Palermo, Ebersole, and Peyman-Dove 1998).



### C.3 Design, Construction, and Operations.

C.3.1 Sequence. The sequence of pit excavations may vary. For example, a large CAD pit may be excavated in its entirety before any contaminated material is placed in it, or a small pit may be filled with contaminated material and capped with clean excavation material from a second small pit, which is then filled with contaminated material and capped with clean excavation material from a third small pit, and so on. The construction of several small pits close to one another with the use of the excavated material as cap reduces the cost of CAD pit construction because of the reduction in haul distances of suitable clean capping material (Rollings 2000).

C.3.2 Slope stability. The stability of the excavated pit slope is an important consideration because the failure risk of the excavated slope is greatest immediately following excavation. However, this poses a relatively small problem because contaminated material is usually placed in and resides in the deepest part of the pit due to its liquid nature (Palermo 1999).

C.3.3 Layering. If dredging schedules allow, materials with higher levels of contamination should be sandwiched between layers of materials with lower levels of contamination. Also, if dredging schedules allow, less contaminated material should be placed in the upper portion of the CAD pit.

C.3.4 Safety precautions. All necessary safety precautions in the dredging and disposal areas should be maintained to prevent accidents, injuries, and loss to any person or property. Forecast weather and sea conditions at the expected operation sites should be monitored continuously to prevent extremely difficult and dangerous procedures. Placement of contaminated material in the CAD pit and placement of capping material should not occur during severe weather events because they provide a greater possibility of contaminant losses.

C.3.5 Silt curtains. During the placement of contaminated material, a silt curtain may be considered for deployment between barges to limit the dispersion of plumes formed during the placement procedures and to distribute the material evenly in the pit (Shaw, Whiteside, and Ng 1998). Some CAD pit management suggest, however, that silt curtains have little benefit in containing released sediment and may actually be a detriment to placement operations (Whiteside, Ng, and Lee 1996).

C.3.6 Resuspension. An important concern is the resuspension of unconsolidated contaminated material while it is uncapped (Walter, Valente, and Fredette 2002). The frequency of passage of large vessels and the speed of these vessels greatly influence the amount of material resuspended; however, research shows that the amount of material lost is relatively small (Fredette et al. 2000). Most of the resuspended material settles to the bottom within 1 hour of disturbance.

### C.4 Cap Design and Material.

C.4.1 Cap design. Caps are useful for providing immediate isolation of the contaminated material. Cap design should consider the composition, thickness, and the placement method of the capping material for long-term subaqueous containment. (Clarke, Palermo, and Sturgis

2001). A cap may consist of one or more layers of material over the contaminated sediment deposit, and it is usually composed initially of a homogeneous layer of granular material. The cap must be designed to account for the following:

- a. Bioturbation, the movement or alteration of sediment particles or pore water mediated by organisms (Clarke, Palermo, and Sturgis 2001).
- b. Erosion of cap material.
- c. Consolidation of contaminated material.
- d. Long-term chemical and physical isolation.

C.4.2 Bioturbation. Bioturbation generally results in increased sediment water content, decreased sediment cohesion, and increased pore-water exchange, which is likely to increase the surface mixing. The bioturbation process tends to decrease with increasing depth into the cap material, and investigations tend to show that bioturbation activity is very slight below approximately 15-45 cm (0.5-1.5 ft), depending on the local benthic community (Clarke, Palermo, and Sturgis 2001).

C.4.3 Storage capacity. A cap on a CAD facility reduces the storage capacity of the pit. However, the cap has the advantage of immediate isolation when rapid sediment accumulation over the contaminated material is not expected (Morris and Fredette 2002).

C.4.4 Material placement. Spreading techniques should be used to achieve the desired thickness, uniform capping, and complete coverage. When mechanical spreading is employed, care should be exercised to minimize the mixing of capping and contaminated material that is likely to occur during the spreading process. Placement of capping material at equal or lesser density than the contaminated material generally meets this requirement. Careful monitoring of cap placement operations should be undertaken to ensure design objectives are met. Slow placement of cap material has been found to minimize mixing of cap material with contaminated sediments found below. The cap material must also be stable against long-term erosion (Myre, Walter, and Rollings 2000).

C.4.5 Consolidation. The need for the contaminated material to consolidate for some time to develop enough strength to support the capping material needs to be evaluated. As much information as possible should be known about the geotechnical behavior of the dredged material because cohesion and strength of the sediments are altered by the dredging process. The shear strength of the material is lowered, and the water content is increased. Capping may take place in stages of placement of clean sand, clean mud (optional), and additional clean mud (optional) after allowing for consolidation of the contaminated material (Whiteside, Ng, and Lee 1996). Final capping may be delayed for a period of up to 1 year to allow for maximum consolidation, but generally the allowable consolidation time period is approximately 3-6 months. Consolidation rates have been found to be highest immediately following placement and are reduced considerably with time. Little data exist that provide guidance on how to determine when sediments have sufficient strength to be capped.

C.4.6 Consolidation of material varies widely and volume reduction up to 50% has been observed depending upon water content and material composition. Consolidation rates also are dependent upon drainage paths, pore pressure gradient, and rate of filling (Myre, Walter, and Rollings 2000).

C.4.7 Mixing of the contaminated dredged material and the cap is significantly reduced by maximizing the consolidation of the contaminated material. Mixing of the contaminated sediment and the cap is minimized by the minimal use of props on vessel placing the cap material.

C.4.8 If erosion is the only consideration, coarse material may be the most desirable cap material. Coarse sand may be a problem if the contaminated material is a fine silty material with a high water content. Clean silty sediment may be used if consolidation of the contaminated sediment is not allowed to take place. As the difference between the density of the contaminated material approaches zero, the potential for mixing will also substantially decrease.

C.4.9 Interim caps may be required for large pits for temporary isolation of contaminated material due to varying dredging schedules.

C.4.10 Consolidation of the contaminated sediments near the sediment-cap boundary is promoted by the placement of capping material. Also the shear strength increases with depth in the consolidated material due to the weight of the capping material. Some data suggest that the processing of pre-capping was more effective in increasing the bearing strength of the sediment than self-weight consolidation.

## C.5 Monitoring.

C.5.1 Monitoring of the CAD pit is an essential part of the isolation process of contaminated sediments. Monitoring is useful before, during, and following the placement of contaminated material to ensure that the cap is properly constructed and that the amount of material released to the surroundings is within acceptable limits. The monitoring plans should be more intensive during and shortly after placement operations and will decline in future years. Monitoring should involve both the cumulative impact on the surrounding environment and pit-specific compliance (Whiteside, Ng, and Lee 1996; Shaw, Whiteside, and Ng 1998).

C.5.2 The monitoring plan should consider the following components:

- a. Physical.
- b. Chemical.
- c. Ecological/biological.

C.5.3 The physical components are the release of small amounts of pore water with associated contaminants during consolidation and the very slow process (thousands of years) of diffusion of contaminants (Murray et al. 1998).

C.5.4 Post capping monitoring techniques include the following:

- a. Precision bathymetry.
- b. Subbottom profiling.
- c. Coring.

C.5.5 Bioaccumulation of contaminants by plants and animals that inhabit the CAD pit environment should be considered as part of the monitoring process.

C.5.6 Upon completion of filling of the CAD pits and capping with clean material, detailed bathymetric surveys and penetrometer testing should be performed to verify the integrity of the cap thickness and composition. Bathymetric surveys may be of limited use because of varying rates of consolidation of sediments.

C.6 Conclusions. Confined aquatic disposal of contaminated sediments is a practical and effective means of permanently isolating the material from the environment. Factors that should be considered are pit site selection, construction, operation, cap design and monitoring.

APPENDIX D

Plant Materials for Beneficial Use Sites

D.1 Plants for Habitat Development. Table D-1 identifies and describes selected upland plant species for habitat development on dredged material sites.

Table D-1. Selected Upland Plant Species for Habitat Development on Dredged Material Sites (Landin 1978)

Species* (Alphabetized by Common Name)	Best Propagule Type	Collection Periods**	Temporary Storage Requirements**	Planting Periods**	Range†	Mature Height	Growth Habits	Remarks
<u>Grasses</u>								
American beachgrass <sup>1,2,3</sup>	Transplants	Oct-Mar	In wet sand beds or in pots of sand	Feb-May	MA, NE, GL	To 1.5 m/ 5 ft	Perennial cool season grass with stiff stems, full sun	Tolerates saline conditions, beach/dune areas, excellent for sandy beach/dune areas
American dunegrass <sup>1,3</sup>	Transplants	Sep-Mar	In wet sand beds or in pots of sand	Mar-Jun	NE, RNW	To 1.5 m/ 5 ft	Strong, erect fast growing, full sun	Prefers sand areas, good soil stabilizer
Bahia grass <sup>1,3</sup>	Seeds	Jul-Sep	Dry, cool area	Mar-Jun	SE, MA, FL, MS	To 15 cm/ 6 in	Summer perennial, creeping base, upright stems, full sun	Cultivated for pasture, good cover, wide range of soils
Barley <sup>1,2,3</sup>	Seeds	May-Jul	Dry, cool area	Oct-Nov	Entire U.S.	To 1.2 m/ 4 ft	Annual winter cover crop grass, full sun	Extensively cultivated for cover/grain, requires good soil bed
Barnyard grass <sup>1,3</sup>	Seeds	Jun-Sep	Dry, cool area	May-Sep	Entire U.S. except FL	To 1.8 m/ 6 ft	Annual grass, arching heads, full sun	Prefers moist soils, cultivated for waterfowl food
Beach panic grass <sup>1</sup>	Transplants	Sep-Mar	In wet sand beds or pots of sand	Mar-Jun	MA, SE, FL, MS	To 1.2 m/ 4 ft	Perennial, few flowered, full sun	Prefers sandy soils
Beaked panic grass <sup>1</sup>	Seeds	Jul-Sep	Dry, cool area	Apr-Jun	MA, SE, FL, MS, MRV, SP, MP	To 1.8 m/ 6 ft	Perennial, hardy, fast growing, full sun	Prefers moist sandy soil
Big bluestem <sup>1,3</sup>	Seeds	Jul-Sep	Dry, cool area	Apr-Jun	Entire U.S. except PNW, CA	To 1.8 m/ 6 ft	Perennial, robust, tufted, dense sod, full sun	Important forage grass, prefers well-drained soils

(Sheet 1 of 35)

\* Numbers given after species names indicate the following information:

- 1 - Known to occur on dredged material.
- 2 - Planted on dredged material sites.
- 3 - Known to be available commercially or from State and Federal nurseries.

\*\* Collection periods, storage requirements and planting periods are only for best propagules. Many of these species may be handled in other ways for other propagule types not portrayed in this table.

† SE = southeast; MS = midsouth; SP = south plains; MP = mid plains; NP = north plains; NE = northeast; MA = mid Atlantic; PNW = Pacific northwest; SW = southwest; FL = Florida; GL = Great Lakes; MRV = Mississippi River Valley; CA = California; MW = Midwest.

D-1

EM 1110-2-5025  
31 Jul 15

Table D-1 (Continued)

Species* (Alphabetized by Common Name)	Best Propagule Type	Collection Periods**	Temporary Storage Requirements**	Planting Periods**	Range†	Mature Height	Growth Habits	Remarks
<u>Grasses (Continued)</u>								
Bromegrass <sup>1,3</sup>	Seeds	Jul-Sep	Dry, cool area	Apr-Jun	Entire U.S. except SE, FL, MS, SP	To 1.8 m/ 6 ft	Perennial, creeping rhizomes, erect stems, dense sod, full sun	Important forage, grass, prefers well-drained soils
Bromesedge <sup>1</sup>	Seeds	Sep-Oct	Dry, cool area	May-Sep	Entire eastern U.S. and CA	To 0.9 m/ 3 ft	Perennial, dense culm, upright stems, full sun	Pest plant in pastures/crops, grows under most soil conditions
Browntop millet <sup>3</sup>	Seeds	Sep-Nov	Dry, cool area	Mar-Jul	SE, MA, MS, FL	To 23 cm/ 9 in	Summer annual, erect stems, good seed producer, full sun	Prefers wet soils, excellent waterfowl food, no soil preparation necessary in many cases
Bull paspalum <sup>1</sup>	Seeds	Jul-Oct	Dry, cool room	Mar-Jun	MA, SE, FL, MS	To 1.8 m/ 6 ft	Stout summer annual, fast growing, spreading, full sun	Prefers moist soils, good seed producer
Bushy beardgrass <sup>1</sup>	Seeds	Aug-Oct	Dry, cool area	Apr-Jun	NE, MA, SE, FL, MS, SP, SW, CA	To 1.8 m/ 6 ft	Erect dense, fast growing, full sun	Prefers moist soils
Calley Bermuda grass <sup>3</sup>	Transplants, rootstock	Year-round	In soil beds	Mar-Jun	SE, MS, SP, FL	To 15 cm/ 6 in	Perennial, fast growing, sterile, full sun	Vigorous new hybrid Bermuda, pasture use
Coastal Bermuda grass <sup>3</sup>	Transplants, rootstock	Year-round	In soil beds	Mar-Jun	SE, MA, FL, SP, MS	To 15 cm/ 6 in	Perennial, fast growing, sterile, full sun	Planted extensively in southern pastures for grazing/hay, tolerates salt spray
Common Bermuda grass <sup>1,3</sup>	Seeds	Jun-Sep	Dry, cool area	Apr-Jun	Entire U.S. except MW, PNW, NP, NE	To 5-10 cm/ 2-4 in.	Perennial, fast growing, abundant seeds, full sun	Pasture crop, lawns, pest in cultivated areas, tolerates wide range of conditions
Common reed <sup>1</sup>	Rootstock, rhizomes	Sep-Mar	In sand beds or pots of sand	Feb-Jun	GL, NE, MA, SE, FL, MS, SP	To 3.7 m/ 12 ft	Perennial, fast growing persistent, full sun	Pest plant in many areas, not recommended for any use other than soil stabilization
Corn <sup>1,2,3</sup>	Seeds	Jul-Oct	Dry, cool area	Mar-Jun	Entire U.S.	To 2.7-3.0 m/ 9-10 ft	Summer annual, upright heavy seed producer, full sun	Cultivated extensively for grain/silage/human consumption

Table D-1 (Continued)

Species* (Alphabetized by Common Name)	Best Propagule Type	Collection Periods**	Temporary Storage Requirements**	Planting Periods**	Range†	Mature Height	Growth Habits	Remarks
<u>Grasses (Continued)</u>								
Dallis grass <sup>1,3</sup>	Seeds	Jun-Sep	Dry, cool area	Year-round (MS, FL); Apr-May (north)	SE, MS, FL, MA, SP, SW	To 1.5 m/ 5 ft	Dense perennial, full sun	Cultivated pasture grass
Deertongue <sup>1</sup>	Seeds	Aug-Oct	Dry, cool area	Oct-Nov; Mar-Apr	NE, MA, SE, MS, MP, NP, MRV	To 1.5 m/ 5 ft	Warm season, full sun, dense clumps	Tolerates acid soils, seeds have strong dormancy
European beachgrass <sup>1,3</sup>	Transplants	Oct-Mar	Hold in wet sand beds or in sand pots	Feb-May	PNW, CA	To 1.5 m/ 5 ft	Perennial, cool season grass, rigid stems, full sun	Tolerates saline conditions, excellent for sand beach/dune areas
Fall panic grass <sup>1</sup>	Seeds	Sep-Nov	Dry, cool area	Feb-Jun	Entire U.S. NP, PNW	To 0.9 m/ 3 ft	Coarse, summer annual, fast growing, good seed producer, full sun	Tolerates wide range of soil conditions including wet areas, considered crop pest plant
Foxtail millet <sup>3</sup>	Seeds	Jun-Sep	Dry, cool area	Apr-Jul	Entire U.S. except MW, FL, SP	To 1.8 m/ 6 ft	Summer annual, upright, fast growth, full sun	Cultivated extensively for grain/silage, prefers moist soils
Goose grass <sup>1</sup>	Seeds	Jun-Sep	Dry, cool area	Apr-Jul	Entire U.S. except NP, PNW	To 15 cm/ 6 in	Small culmed perennial, heavy seed producer, full sun	Pest plant in cultivated areas, grows in most soil conditions
Green bristlegrass <sup>1</sup>	Seeds	Jul-Oct	Dry, cool area	Apr-Jul	Entire U.S.	To 0.9 m/ 3 ft	Vigorous summer annual, clumped, full sun	Occurs in many soils, pest in crops, not palatable to browsers
Italian ryegrass <sup>1</sup>	Seeds	May-Jul	Dry, cool area	Oct-Nov	Eastern U.S. and SP, NP, PNW, CA	To 0.9 m/ 3 ft	Perennial in south, in north, hardy, forms dense root system, full sun	Cultivated for winter grazing/ quick winter cover/lawns
Japanese millet <sup>3</sup>	Seeds	Jun-Sep	Dry, cool area	Apr-Sep	Entire U.S. except FL	To 1.5 m/ 5 ft	Tall heavy annual, abundant seeds, full sun	Occurs in all soils, grown for waterfowl/cattle feed, is salt tolerant to some extent

(Sheet 3 of 35)

Table D-1 (Continued)

Species* (Alphabetized by Common Name)	Best Propagule Type	Collection Periods**	Temporary Storage Requirements**	Planting Periods**	Range†	Mature Height	Growth Habits	Remarks
<u>Grasses (Continued)</u>								
Johnson grass <sup>1,3</sup>	Seeds	Jul-Oct	Dry, cool area	Apr-Sep	Entire U.S. except NP, MW, PNW	To 1.5 m/ 5 ft	Hardy, fast growing, erect, strong seed producer, full sun	Planted for pastures/hay, pest plant in cultivated areas
Jungle rice <sup>1</sup>	Seeds	Jun-Sep	Dry, cool area	May-Sep	Entire U.S. except NP, MW	To 8-10 cm/ 3-4 in	Perennial, prostrate to erect, full sun	Good seed producer, prefers wet to moist soils
Large crabgrass <sup>1</sup>	Seeds	Jun-Sep	Dry, cool area	Apr-Sep	Entire U.S. except NP	To 0.3 m/ 1 ft	Creeping annual fast growing, full sun	Occurs in all soils, pest in cultivated areas, immune to herbicides
Little hairgrass <sup>1</sup>	Seeds	Jun-Aug	Dry, cool area	Apr-Jun	MA, PNW, CA	To 25 cm/ 10 in	Annual, tufted culms, full sun	Prefers sand, dry coastal soils
Oats <sup>3</sup>	Seeds	May-Jun	Dry, cool area	Sep-Oct	Entire U.S.	To 0.9 m/ 3 ft	Cool season annual, agronomic cereal crop, full sun	Occurs in almost all soil conditions, needs well-prepared seed bed
Orchardgrass <sup>1,3</sup>	Seeds	Jun-Aug	Dry, cool area	Mar-Sep	Entire U.S.	To 1.2 m/ 4 ft	Clumped, perennial hardy, full sun to shade	Prefers well-drained soils, does well in many soils, cultivated for grazing/hay/ silage
Panic grass <sup>1</sup>	Seeds	Jun-Aug	Dry, cool area	Mar-Jun	Eastern and mid-U.S.	To 1.2 m/ 4 ft	Dense clumped perennials, strong rhizomes, full sun	Prefers moist sandy soil
Pearl millet <sup>3</sup>	Seeds	Sep-Oct	Dry, cool area	Mar-Jun	MA, SE, SP, SW	To 1.8 m/ 6 ft	Robust, summer annual, heavy seed producer, full sun	Cultivated for grain/silage, prefers moist soil but tolerates drought
Perennial ryegrass <sup>1,3</sup>	Seeds	May-Jul	Dry, cool area	Sep-Nov	SE, MS, SP, FL	To 0.9 m/ 3 ft	Hardy, dense root system, full sun	Good winter cover, good winter wildlife food/cattle forage in the south
Prairie cordgrass <sup>1,2,3</sup>	Seeds	Jul-Oct	Dry, cool area	Apr-Jun	Entire U.S. except SE, FL, MS, CA	To 2.7 m/ 9 ft	Tall perennial, full sun	Occurs in wet, coastal areas
Proso millet <sup>3</sup>	Seeds	Sep-Oct	Dry, cool area	Mar-Jun	MW, SP	To 1.2 m/ 4 ft	Summer annual, erect stems, full sun	Produces seeds 4 months after planting, good food value, cultivated for grain



Table D-1 (Continued)

Species* (Alphabetized by Common Name)	Best Propagule Type	Collection Periods**	Temporary Storage Requirements**	Planting Periods**	Range†	Mature Height	Growth Habits	Remarks
<u>Grasses (Continued)</u>								
Quackgrass <sup>1</sup>	Rootstock	Sep-Mar	In sand beds or pots of sand	Mar-Jun	Entire U.S.	To 1.2 m/ 4 ft	Perennial, long running root stock, hardy, full sun	Pest plant, exotic
Red fescue <sup>1,3</sup>	Seeds	May-Aug (north)	Dry, cool area	Mar-May (north)	Entire U.S. except FL, SP, MS, SE	To 0.9 m/ 3 ft	Hardy robust creeping grass forms a dense sod, shade to full sun	Cultivated extensively in mixed stands for pastures/lawns/and rights-of-ways
Redtop <sup>1,3</sup>	Seeds	Aug-Oct	Dry, cool area	Apr-Jun	Entire U.S.	To 0.9 m/ 3 ft	Tall hardy, stoloniferous, full sun	Cultivated for silage/hay/ grazing
Red canary grass <sup>1,3</sup>	Seeds	Jun-Aug	Dry, cool area	Mar-Jun	Entire U.S.	To 1.8 m/ 6 ft	Summer perennial, robust, fast growth, full sun	Prefers moist soil, but grows anywhere, cultivated on sewage areas/for pastures, good seed producer
Rescue grass <sup>1,3</sup>	Seeds	Jul-Oct	Dry, cool area	Apr-Jun	SE, MA, CA, SW	To 0.9 m/ 3 ft	Robust, summer perennial, full sun	Cultivated in south as forage
Rice cutgrass <sup>1</sup>	Seeds	Aug-Oct	Dry, cool area	Apr-Jul	Entire U.S.	To 1.2 m/ 4 ft	Dense culms, perennial, much branched, shade to full sun	Prefers moist/wet soils
Rye <sup>3</sup>	Seeds	May-Jul	Dry, cool area	Sep-Nov (south); Apr-May (north)	Entire U.S.	To 0.9 m/ 3 ft	Hardy cool season annual, high speed producer, full sun	Cultivated extensively for grain/cover/green forage crops, especially in north
Saltgrass <sup>1,2,3</sup>	Transplants, seeds	Sep-May Jul-Sep	In wet sand beds or in pots of sand	Mar-Jun	Entire U.S. in saline areas except PNW, CA	To 0.3 m/ 1 ft	Dense perennial, hardy, many rhizomes, good seed producer, full sun	Prefers moist coastal areas, occurs in salt marshes/on sand dunes
Saltmeadow cordgrass <sup>1,2,3</sup>	Transplants, seedlings	Year-round (south); Mar-Oct (north)	In wet sand beds or in sand pots	Feb-Jun	NE, MA, SE, FL, MS, SP	To 0.9 m/ 3 ft	Densely rooted, summer perennial, spreads best from tillers	Occurs in flooded saline areas to dry sand dunes, is successfully planted on dredged material
Sand dropseed <sup>1</sup>	Seeds	Sep-Oct	Dry, cool area	Apr-Jul	Entire U.S.	To 0.9 m/ 3 ft	Erect perennial, hardy, slow growing, full sun	Prefers sandy soils, grows on prairie areas

(Sheet 5 of 35)

Table D-1 (Continued)

Species* (Alphabetized by Common Name)	Best Propagule Type	Collection Periods**	Temporary Storage Requirements**	Planting Periods**	Range†	Mature Height	Growth Habits	Remarks
<u>Grasses (Continued)</u>								
Sea oats <sup>1,2,3</sup>	Transplants, seeds	Sep-Mar (trans); Aug-Oct (seeds)	In wet sand beds	Mar-Jun	MA, SE, FL, MS	To 1.8 m/ 6 ft	Robust perennial, dense roots, full sun	Prefers sandy, coastal areas, excellent dune stabilizer, tolerates salt spray
Seashore bluegrass <sup>1</sup>	Transplants	Sep-Mar	In wet sand beds or pots of sand	Mar-Jun	PNW, CA	To 0.3 m/ 1 ft	Creeping rhizomous perennial with upright culms, full sun	Prefers coastal sand dunes
Seashore paspalum <sup>1</sup>	Transplants	Sep-Mar	In wet sand beds or in sand pots	Sep-Jun	SE, FL, MS	To 0.3 m/ 1 ft	Dense perennial, fast growing, full sun	Tolerates flooding/salt spray, occurs on dredged material islands in dense stands
Shoredune panic grass <sup>1</sup>	Seeds	Sep-Oct	Dry, cool area	Mar-May	NE, MA, FL, MS, SP	To 1.8 m/ 6 ft	Upright, coarse, perennial, fast growing, full sun	Prefers sandy beach soils, tolerates salt sprays, occurs on dredged material islands
Sixweeks fescue <sup>3</sup>	Seeds	May-Jun	Dry, cool area	Mar-May	Entire U.S.	To 0.3 m/ 1 ft	Annual, fast seed producer, full sun or shade	Cultivated as forage/hay crops
Smooth crabgrass <sup>1</sup>	Seeds	Jun-Sep	Dry, cool area	Apr-Sep	Entire U.S. except SW	To 0.3 m/ 1 ft	Creeping, fast growing, annual, full sun	Occurs in many soil types, a pest in cultivated fields/gardens
Sorghum <sup>3</sup>	Seeds	Jul-Oct	Dry, cool area	Apr-Sep	Entire U.S.	To 1.8 m/ 6 ft	Upright, summer annual, heavy seed producer, full sun	Cultivated extensively as grain/silage crop, tolerates wide range of soils
Sudan grass <sup>3</sup>	Seeds	Jul-Oct	Dry, cool area	Apr-Jul	Entire U.S. except NP, NE, PNW	To 2.7 m/ 9 ft	Wandering, upright annual, hardy, fast growing, full sun	Cultivated for hay/silage, tolerates wide range of soils
Switchgrass <sup>1,3</sup>	Seeds	Jun-Sep	Dry, cool area	Apr-Sep	Entire U.S. except NP, PNW, CA	To 1.8 m/ 6 ft	Summer perennial, fast growing, hardy, full sun	Prefers moist soils, grows at water's edge, tolerant of salt spray
Tall fescue <sup>1,2,3</sup>	Seeds	Apr-Jun (south); May-Aug (north)	Dry, cool area	Oct-Nov (south); Mar-May (north)	Eastern U.S. except FL; MP, PNW	To 1.5 m/ 5 ft	Cool weather grass in south, summer grass in north, full sun	Cultivated for pastures

Table D-1 (Continued)

Species* (Alphabetized by Common Name)	Best Propagule Type	Collection Periods**	Temporary Storage Requirements**	Planting Periods**	Range†	Mature Height	Growth Habits	Remarks
<u>Grasses (Continued)</u>								
Texas millet	Seeds	Jul-Oct	Dry, cool area	Mar-Aug	MA, SE, FL, MS, SP	To 1.8 m/ 6 ft	Summer annual with spreading stems, full sun	Fast growing, considered crop weed, grows well on sand dunes
Timothy <sup>1,2,3</sup>	Seeds	Jul-Sep	Dry, cool area	Apr-Jun	Entire U.S. except SP, FL, MS	To 0.9 m/ 3 ft	Summer perennial, fast growing, erect, full sun	Cultivated extensively in North America for hay
Torpedo grass <sup>1</sup>	Transplants	Sep-Mar	In wet soil beds or pots of sand	Sep-Jun	FL, MS, SP	To 10 cm/ 4 in	Stout perennials, many rhizomes, dense cover, full sun	Sea beaches, prefers sandy moist soils, tolerates salt spray
Vasey grass <sup>1</sup>	Seeds	Jul-Sep	Dry, cool area	Apr-Jun	FL, SE, MA, MS, SP, CA	To 1.8 m/ 6 ft	Clumped, stout perennial, erect, hardy, full sun	Prefers moist soil, pasture grass, roadside cover
Virginia dropseed <sup>1</sup>	Seeds	Jun-Sep	Dry, cool area	Apr-Jun	MA, FL, MS	To 0.3 m/ 1 ft	Perennial, branching rhizomes, erect, culms, full sun	Occurs on sandy/muddy seashores, tolerates salt spray
Walter's millet <sup>1,3</sup>	Seeds	Jul-Sep	Dry, cool area	Apr-Sep	SP, MS, FL, SE, MA, NE, GL	To 2.7 m/ 9 ft	Stiff stems, abundant seeds, annual, full sun	Occurs in all soils, cultivated for waterfowl food, prefers wet soils
Wheat <sup>3</sup>	Seeds	May-Jul	Dry, cool area	Oct-Nov (winter); Mar-May (spring)	Entire U.S.	To 0.9 m/ 3 ft	Winter annual, good seed producer, hardy, full sun	Cultivated extensively, tolerates cold, good cover/food crop
Wild rye <sup>1</sup>	Seeds	Mar-Jul	Dry, cool area	Sep-Jun	Entire U.S. except CA	To 1.2 m/ 4 ft	Perennial, tufted, erect culms, heavy seeds, full sun	Prefers moist soils, good seed producer, tolerates salt spray somewhat
Woolly panic grass <sup>1</sup>	Seeds	Jul-Sep	Dry, cool area	Apr-Jun	MA, SE, FL, MS	To 0.6 m/ 2 ft	Perennial, clumped spreading shade/sun	Prefers moist soils, grows in woods/open areas, occurs on sea coast
Yellow bristlegrass	Seeds	Jul-Oct	Dry, cool area	Apr-Jul	Entire U.S. except SW, CA	To 0.9 m/ 3 ft	Summer annual, good seed producer, full sun	Occurs in many soil conditions, pest in crops, not palatable to browsers

(Sheet 7 of 35)

Table D-1 (Continued)

Species* (Alphabetized by Common Name)	Best Propagule Type	Collection Periods**	Temporary Storage Requirements**	Planting Periods**	Range†	Mature Height	Growth Habits	Remarks
<u>Herbs</u>								
Alfalfa <sup>3</sup>	Seeds (inoculated)	Jul-Sep	Dry, cool area	Aug-Sep; or Feb-Apr	Entire U.S.	To 0.6 m/2 ft	Perennial, much-branched legume, full sun	Requires good seedbed preparation, occurs on most soils, prefers rich, moist areas
Alsike clover	Seeds (inoculated)	Mar-Apr (south); Jun-Sep (north)	Dry, cool area	Nov-Feb (south); Mar-Jun (north)	Entire U.S.	To 0.6 m/2 ft	Perennial, ascending branches, full sun	Prefers moist, acidic soils, cultivated in areas where clovers won't grow
Arrow-leaved tearthumb <sup>1</sup>	Transplants, seeds	Jul-Sep	Dry, cool area	Mar-Jun	Eastern and mid-U.S.	To 0.6 m/2 ft	Viney, annual, weak stemmed, spiny, full sun	Prefers moist soils
Beach pea <sup>1</sup>	Seeds (inoculated)	May-Sep	Dry, cool area	Feb-Jun	Entire coastal U.S.	To 0.3 m/1 ft	Perennial, viney plant, hardy, full sun	Prefers sandy moist soils, occurs on coastal beaches/dunes/islands
Beach strawberry	Transplants	Sep-Mar	In sand beds or in pots of sand	Mar-Jun	PNW, SW	To 20 cm/8 in	Perennial plants with runners, full sun to shade	Prefers moist sandy soils
Big filaree	Seeds	Apr-Jul	Dry, cool area	Sep-Nov	CA	To 20 cm/8 in	Winter annual, full sun	Pest plant, occurs in most well-drained soils
Bird's foot trefoil <sup>1</sup>	Seeds (inoculated)	Jun-Sep	Dry, cool area	Mar-Jun	NE, MA	To 0.6 m/2 ft	Long rooted perennial, full sun	Pest plant, occurs in most soils, common coasts
Bittersweet nightshade <sup>1</sup>	Seeds	May-Sep	Dry, cool area	Apr-May	NE, MA, NP	To 2.4 m/8 ft	Perennial, climbing stem, full sun to shade	Prefers moist soils/in woods, but grows in open areas
Black medic <sup>1,3</sup>	Seeds (inoculated)	Mar-Jun (south); Jun-Aug (north)	Dry, cool area	Nov-Feb (south); Mar-Jun (north)	Entire U.S.	To 0.3 m/1 ft	Annual, shallow taproot, full sun	Prefers well-drained or dry soils, dormant in south in the summer
Black nightshade <sup>1</sup>	Seeds	Jul-Oct	Dry, cool area	Apr-Jun	Eastern U.S.	To 0.9 m/3 ft	Erect, annual, hairy, hardy, full sun	Pest in cultivated areas, occurs in most soils
Blackseed plantain <sup>1</sup>	Seeds	Jun-Sep	Dry, cool area	Apr-Jun	Eastern and mid U.S.	To 0.9 m/3 ft	Perennial, rootstock, stout, thick, erect, hardy, full sun or shade	Pest plant, occurs in woods/fields/waste areas

Table D-1 (Continued)

Species* (Alphabetized by Common Name)	Best Propagule Type	Collection Periods**	Temporary Storage Requirements**	Planting Periods**	Range†	Mature Height	Growth Habits	Remarks
<u>Herbs (Continued)</u>								
Bottlebrush <sup>1</sup>	Seeds	May-Oct	Dry, cool area	Apr-Jun	Eastern U.S.	To 0.9 m/ 3 ft	Annual, many branched stem, full sun	Prefers well-drained open areas
Bracted plantain <sup>1</sup>	Seeds	Jun-Oct	Dry, cool area	Apr-Jun	Entire U.S. except, MW, PNW, CA, SW	To 0.6 m/ 2 ft	Perennial, stout root- stock, erect, full sun	Prefers dry open areas
Broadleaf plantain <sup>1</sup>	Seeds	May-Sep	Dry, cool area	Apr-Jun	Entire U.S.	To 20 cm/ 8 in	Perennial, rootstock short, thick, erect, full sun	Occurs in most soils, in waste places
Buckthorn plantain <sup>1</sup>	Seeds	Apr-Nov	Dry, cool area	Mar-Jun	Eastern U.S.	To 0.3 m/ 1 ft	Perennial, pubescent, short root-stock, full sun	In fields/waste places
Bush lupine	Seeds	Jun-Sep	Dry, cool area; soak in hot water before planting	Apr-Jun	PNW, CA	To 0.6 m/ 2 ft	Perennial, many branched, shrubby, full sun	In dry, open areas
Calandrinia	Seeds	Jul-Sep	Dry, cool area	Mar-Jun	CA	--	--	In dry scrub areas, sandy coastal beaches
Camphorweed <sup>1</sup>	Seeds	Jul-Sep	Dry, cool area	Apr-Jun	MA, SE, FL, MS, SW, SP, MP	To 0.9 m/ 3 ft	Biennial, many branched, many flowered, full sun	Prefers dry, sandy soils, sea beaches, occurs commonly on dredged material islands
Chufa <sup>1,2,3</sup>	Tubers, seeds	Jul-Oct	Moist cold room (tubers) Dry, cool area (seeds)	Mar-Jun	Entire U.S.	To 0.6 m/ 2 ft	Perennial sedge, robust, fast growing, numerous edible tubers, full sun	Prefers wet to moist soils, prime wildlife food, extremely prolific
Coast deervetch	Seeds (inoculated)	Jun-Sep	Dry, cool area	Apr-Jun	PNW, CA	To 0.6 m/ 2 ft	Perennial, long roots, slender stems, full sun	Prefers dry, well-drained soils
Common chickweed <sup>1</sup>	Seeds	Dec-Feb	Dry, cool area	Oct-Dec	Entire U.S.	To 0.6 m/ 2 ft	Weak, tufted annual, much branched, full sun	Pest plant in all agronomic situations
Common filaree <sup>1</sup>	Seeds	Apr-Jul	Dry, cool area	Sep-Nov	NE, MA, SE, SP, GL, PNW, CA	To 15 cm/ 6 in	Winter annual, taproots, many branched, full sun	Pest plant, occurs in most soils, prefers well-drained soils
Common lambsquarters <sup>1</sup>	Seeds	Jun-Oct	Dry, cool area	Apr-Jun	Entire U.S.	To 1.2 m/ 4 ft	Annual erect, bushy common, shade to full sun	Pest plant, occurs in most soils, occurs on dredged material islands

(Sheet 9 of 35)

Table D-1 (Continued)

Species* (Alphabetized by Common Name)	Best Propagule Type	Collection Periods**	Temporary Storage Requirements**	Planting Periods**	Range†	Mature Height	Growth Habits	Remarks
<u>Herbs (Continued)</u>								
Common mullein <sup>1</sup>	Seeds	Jun-Sep	Dry, cool area	Apr-Jun	Entire U.S.	To 2.1 m/ 7 ft	Erect, stout, biennial, full sun	Pest plant, occurs in open well-drained areas
Common purslane <sup>1</sup>	Seeds	Jun-Sep	Dry, cool area	Apr-Jun	Entire U.S.	To 15 cm/ 6 in	Annual, prostrate, free branching, deep roots, full sun	Prefers dry sandy areas
Common ragweed <sup>1</sup>	Seeds	Sep-Nov	Dry, cool area	Apr-Jun	Entire U.S.	To 0.6 m/ 2 ft	Annual, shallow roots, robust, common full sun	Pest plant, occurs in most soils, tolerates salt spray, occurs on dredged material islands
Common spikerush <sup>1</sup>	Transplants, seeds	Apr-Sep	In sand beds (trans.) moist, cool area	Apr-Sep	Entire U.S.	To 0.6 m/ 2 ft	Perennial, upright, slender stems, full sun	Occurs in moist soils in interior areas
Common threesquare <sup>1</sup>	Transplants, seeds	Sep-Mar (trans); Jul-Oct (seeds)	In sand beds (trans.) moist cool area	Mar-Jun	Entire U.S. except SW	To 1.8 m/ 6 ft	Perennial, upright, triangular stems, full sun	Occurs in moist soils in fresh/brackish areas, good wildlife food
Cow pea <sup>1</sup>	Seeds (inoculated)	Jun-Sep	Dry, cool area	Mar-Sep	Entire U.S.	To 0.6 m/ 2 ft	Summer annual, viney, fast growing, good seed producer, full sun	Cultivated in most soils for human food/hay/forage, especially in the south
Crimson clover <sup>3</sup>	Seeds (inoculated)	Mar-Apr (south); Jun-Sep (north)	Dry, cool area	Dec-Feb (south); Mar-Jul (north)	Entire U.S.	To 0.6 m/ 2 ft	Strong perennial in south, annual in north, procumbent stems, fast growing	Cultivated on most soils for hay/grazing and on rights-of-ways
Croton	Seeds	Aug-Oct	Dry, cool area	Apr-Jun	CA, SW	To 0.9 m/ 3 ft	Many branched, stout annual, robust, full sun	Occurs in waste areas/dry soils, pest plant
Curly dock <sup>1</sup>	Seeds	Apr-Jul	Dry, cool area	Apr-Jun	Entire U.S.	To 1.2 m/ 4 ft	Perennial, stout, deep tap root, erect, persistent, full sun	Pest plant, occurs in waste areas/crops and in most soils
Deerweed	Seeds	Jun-Sep	Dry, cool area	Apr-Jun	CA	To 0.6 m/ 2 ft	Perennial, long tap roots, full sun	Occurs in waste areas, dry soils

Table D-1 (Continued)								
Species* (Alphabetized by Common Name)	Best Propagule Type	Collection Periods**	Temporary Storage Requirements**	Planting Periods**	Range†	Mature Height	Growth Habits	Remarks
<u>Herbs (Continued)</u>								
Dwarf spikerush <sup>1</sup>	Transplants, seeds	Mar-Nov (trans); Jun-Sep (seeds)	In sand beds; dry, cool area	Mar-Jun	Entire U.S. except SW	To 0.9 m/3 ft	Perennial, tiny stems, turf-like, full sun	Occurs in moist soils in fresh, brackish areas
Filaree	Seeds	Apr-Sep	Dry, cool area	Nov-May	PNW, CA	To 0.3 m/1 ft	Annual, tufted, ascending stems, full sun	Occurs in most soils, waste places/fields, prefers well-drained areas
Flat pea <sup>1,3</sup>	Seeds (inoculated)	May-Sep	Dry, cool area	Feb-Jun	NE, MA, MRV, GL, PNW	To 0.6 m/2 ft	Perennial, viney plant, forms mats, full sun to shade	Occurs in most soils, very slow growing
Flowering spurge <sup>1</sup>	Seeds	Apr-Oct	Dry, cool area	Mar-Jun	Eastern and mid U.S.	To 0.9 m/3 ft	Perennial, long stout rootstock, erect, full sun	Prefers dry soils
Giant ragweed <sup>1</sup>	Seeds	Jul-Oct	Dry, cool area	Apr-Jun	Entire U.S. except PNW, CA	To 4.6 m/15 ft	Annual, stout, erect, persistent, full sun	Pest plant, prefers soil, tolerates salt spray, common on coasts
Goosefoot <sup>1</sup>	Seeds	Jun-Sep	Dry, cool area	Mar-Jun	Entire U.S.	To 0.9 m/3 ft	Annual, scruffy, erect, branched, full sun	Pest plant, occurs in most soils, in waste places
Hairy vetch <sup>3</sup>	Seeds (inoculated)	Mar-Apr (south); Apr-Jul (north)	Dry, cool area	Nov-Feb (south); Mar-May (north)	Entire U.S.	To 0.9 m/3 ft	Annual or biennial, viney, weak, stemmed, fast growing, full sun	Cultivated for forage, occurs in most soils, excellent erosion control
Hardstem bulrush <sup>1,2</sup>	Rhizomes, transplants	Jun-Sep	Dry, cool area	Mar-Jun	Entire U.S.	To 1.8 m/6 ft	Perennial, stout, sharp stem tips, persistent, full sun	Prefers moist soils, pest in low ground pastures, extremely hardy
Hemp sesbania <sup>1</sup>	Seeds	Aug-Nov	Dry, cool area	Mar-Jun	SW, MA, SE, FL, MS, SP	To 3.7 m/12 ft	Annual, legume, widely branched, robust, full sun	Occurs in most soils, in soybean fields
Hop clover <sup>3</sup>	Seeds (inoculated)	Jan-Mar (south); Mar-Jun (north)	Dry, cool area	Oct-Feb (south); Jan-Apr (north)	Entire U.S.	To 0.3 m/1 ft	Winter annual, low, forms carpet, procumbent, full sun	Occurs on poor dry soils, excellent nitrogen fixing legume, crowds out grasses

(Sheet 11 of 35)

Table D-1 (Continued)

Species* (Alphabetized by Common Name)	Best Propagule Type	Collection Periods**	Temporary Storage Requirements**	Planting Periods**	Range†	Mature Height	Growth Habits	Remarks
<u>Herbs (Continued)</u>								
Horse nettle <sup>1</sup>	Seeds	May-Sep	Remove pulpy coat; dry, cool area	Apr-Jun	Eastern U.S. and SP	To 0.6 m/ 2 ft	Perennial, erect, spiny, branched, full sun	Occurs in most dry soils, pest plant in agricultural situations
Horseweed <sup>1</sup>	Seeds	Jun-Nov	Dry, cool area	Apr-Jun	Entire U.S.	To 3 m/ 10 ft	Annual, stout, erect, fast growing, full sun	Pest plant, occurs on most soils, tolerates salt spray, common on dredged material islands
Japanese clover <sup>3</sup>	Seeds (inoculated)	May-Sep	Dry, cool area	Feb-Apr	Entire U.S.	To 0.9 m/ 3 ft	Annual, erect, many branched, full sun	Cultivated for forage/silage, excellent on poor, well-drained soils
Jerusalem artichoke	Seeds	Sep-Oct	Dry, cool area	Apr-Jun	Eastern U.S. mid-U.S.	To 3.7 m/ 12 ft	Perennial, fleshy, rootstock, tubers, stout, erect	Prefers moist soil, tubers are edible
Korean clover <sup>1</sup>	Seeds (inoculated)	May-Sep	Dry, cool area	Feb-Apr	Entire U.S.	To 0.9 m/ 3 ft	Annual, erect, many branched, full sun	Cultivated for forage/hay/silage, excellent on poor, well-drained soils
Ladino clover <sup>3</sup>	Seeds (inoculated)	Mar-Apr (south); Apr-Jul (north)	Dry, cool area	Nov-Jan (south); Feb-Mar (north)	Entire U.S.	To 0.9 m/ 3 ft	Perennial, fast growing, fleshy stems, creeping, full sun	Cultivated for forage/hay/silage, excellent on poor, well-drained soils
Ladysthumb <sup>1</sup>	Seeds	Jun-Oct	Dry, cool area	Apr-Jun	Entire U.S.	To 0.6 m/ 2 ft	Annual, ascending stems, variable branching, full sun	Prefers moist soils, in waste places, pest plant in some areas
Lespedeza <sup>3</sup>	Seeds (inoculated)	May-Sep	Dry, cool area	Feb-May	Entire U.S.	To 0.6 m/ 2 ft	Perennial, shrubby, full sun	Cultivated for forage/hay/silage, highway rights-of-ways, well-drained soils
Lupine	Seeds	May-Sep	Dry, cool area; soak with hot water prior to planting	Apr-Jun	PNW, CA, SW	To 0.6 m/ 2 ft	Perennial, shrubby, full sun	Prefers dry, sandy soils
Malta starthistle <sup>1</sup>	Seeds	Apr-Sep	Dry, cool area	Feb-Apr	Entire U.S.	To 1.2 m/ 4 ft	Annual, much branched, spiny yellow flowers, full sun	Occurs in most soils and in waste/cultivated areas, pest plant



Table D-1 (Continued)								
Species* (Alphabetized by Common Name)	Best Propagule Type	Collection Periods**	Temporary Storage Requirements**	Planting Periods**	Range†	Mature Height	Growth Habits	Remarks
<u>Herbs (Continued)</u>								
Mapleleaf goosefoot <sup>1</sup>	Seeds	Jul-Sep	Dry, cool area	Apr-Jun	Entire U.S. except PNW, CA	To 2.4 m/ 8 ft	Annual, erect, bright green, branched, shade to full sun	Occurs in woods/thickets or in open, most soil types
Marsh pea <sup>1</sup>	Seeds (inoculated)	May-Sep	Dry, cool area	Feb-Jun	Entire U.S.	To 1.2 m/ 4 ft	Perennial, viney shrub, very persistent, full sun	Prefers moist areas
Marsh pepper <sup>1</sup>	Seeds	Jul-Sep	Dry, cool area	Mar-Jun	Entire U.S.	To 0.6 m/ 2 ft	Annual, erect, reddish green, may be branched, full sun	Occurs in moist waste places, sometimes in standing water
Maximillian's sunflower	Seeds	Aug-Nov	Dry, cool area	Apr-Jul	MA, SE, MS, SP, MP, NP, PNW	To 1.8 m/ 6 ft	Upright, coarse, stout, annual, full sun	Occurs in most soils, attractive flowers
Mexican tea <sup>1</sup>	Transplants, seeds	Aug-Oct	Dry, cool area	Apr-Jun	Entire U.S.	To 0.9 m/ 3 ft	Annual in north, perennial in south, much branched, erect, full sun	Pest plant, occurs in most soils, in cultivated/waste areas
Musk filaree	Seeds	Feb-Jul	Dry, cool area	Nov-Apr	CA	To 0.6 m/ 2 ft	Winter annual, semi-erect, full sun	Prefers dry, well-drained soils
Narrowleaf vetch <sup>1,3</sup>	Seeds	Feb-Apr (south); Apr-Jun (north)	Dry, cool area	Oct-Dec (south); Feb-May (north)	Entire U.S.	To 0.9 m/ 3 ft	Perennial, viney, trailing, spreading, full sun	Cultivated for pastures/hay/ silage
Nodding smartweed <sup>1</sup>	Seeds	Jun-Sep	Dry, cool area	Mar-Jun	Entire U.S.	To 0.9 m/ 3 ft	Annual, much branched, nodes, swollen, good seed producer, full sun	Occurs in most soils and in waste/cultivated areas
Nutsedge <sup>1</sup>	Corms, seeds	Jun-Aug	Dry, cool area	Mar-Jun	NP, MP, SP, FL	To 0.6 m/ 2 ft	Perennial, hard oblong corms, ascending, full sun	Occurs in dry fields/on hills
Olney threesquare <sup>1</sup>	Transplants, seeds	Sep-Mar	In sand beds or in sand pots	Apr-Jun	Entire U.S. coastline	To 2.1 m/ 7 ft	Perennial, upright, stems three-winged, full sun	Occurs in coastal/fresh moist areas, tolerates salinity
Orache <sup>1</sup>	Seeds	Aug-Oct	Dry, cool area	Apr-Jun	Entire U.S. coastline	To 0.9 m/ 3 ft	Annual, widely branched fruiting bracts, fleshy, full sun	Occurs in saltmeadows/along coasts/in inland areas

(Sheet 13 of 35)

Table D-1 (Continued)

Species* (Alphabetized by Common Name)	Best Propagule Type	Collection Periods**	Temporary Storage Requirements**	Planting Periods**	Range†	Mature Height	Growth Habits	Remarks
<u>Herbs (Continued)</u>								
Partridge pea <sup>1,3</sup>	Seeds (inoculated)	Jul-Oct	Dry, cool area; soak seeds in water before planting	Apr-Jun	Eastern U.S.	To 0.9 m/3 ft	Annual, widely branched, erect, spreading, full sun	In dry soils, common in south in cultivated fields/disturbed areas
Pennsylvania smartweed <sup>1</sup>	Seeds	Jul-Sep	Dry, cool area	Mar-Jun	Eastern and mid U.S.	To 1.2 m/4 ft	Annual, ascending, branched stems, full sun	Occurs on most soils, prefers moist soil, a sometimes pest plant
Pickleweed <sup>1</sup>	Seeds	May-Aug	Dry, cool area	Apr-Jun	CA, PNW, NE, SW	To 0.9 m/3 ft	Perennial, stout stem, erect, unbranched, full sun	Prefers wet places
Pokeberry <sup>1</sup>	Seeds	Sep-Oct	Dry, cool area	Mar-Jun	Entire U.S. except NP, PNW, MW, SW	To 2.7 m/9 ft	Robust perennial, with several purple stems, full sun to shade	Occurs in most soil types and in waste places
Prostrate knotweed <sup>1</sup>	Seeds	Jun-Oct	Dry, cool area	Apr-Jun	Entire U.S.	To 0.6 m/2 ft	Annual, prostrate or ascending stems, creeping full sun	Pest plant in many areas, occurs in most soils
Prostrate pigweed	Seeds	Jun-Oct	Dry, cool area	Apr-Jun	NE, GL, MRV, NP	To 0.6 m/2 ft	Annual, many branched, prostrate, spreading, full sun	Prefers well-drained soils, occurs in waste areas, pest plant
Prostrate spurge	Seeds	May-Sep	Dry, cool area	Mar-Jun	Entire U.S.	To 0.6 m/2 ft	Perennial, procumbent branches, stout at rootstock, full sun	Prefers well-drained soils
Purple nutsedge <sup>1</sup>	Tubers, seeds	Jul-Sep	Moist, cool area (tubers) dry, cool area (seeds)	Mar-Jul	Entire U.S.	To 0.6 m/2 ft	Perennial, extremely hardy/persistent, full sun	Pest plant in lawns, gardens, fields, pastures
Purple vetch <sup>1</sup>	Seeds (inoculated)	Mar-May (south); May-Jul (north)	Dry, cool area	Nov-Feb (south) Mar-May (north)	Entire U.S.	To 0.9 m/3 ft	Perennial, viney, trailing, spreading, full sun	Cultivated for pastures/hay/silage
Red clover <sup>1,3</sup>	Seeds (inoculated)	Mar-Apr (south); Apr-Sep (north)	Dry, cool area	Jan-Mar (south) Mar-Jun (north)	Entire U.S. except MW	To 0.6 m/2 ft	Perennial, ascending stems, many branched, full sun	Cultivated as forage/hay crops, soil conservation areas

Table D-1 (Continued)

Species* (Alphabetized by Common Name)	Best Propagule Type	Collection Periods**	Temporary Storage Requirements**	Planting Periods**	Range†	Mature Height	Growth Habits	Remarks
<u>Herbs (Continued)</u>								
Redroot pigweed <sup>1</sup>	Seeds	Jun-Oct	Dry, cool area	Mar-Jun	Entire U.S.	To 0.9 m/ 3 ft	Coarse, summer annual, deep red taproot, very hardy, persistent, shade to full sun	Occurs on most soil types, pest plant in agronomic/feedlot situations
Reseeding soybean <sup>3</sup>	Seeds	Sep-Nov	Dry, cool area	Mar-Jul	SE, MS	To 3.7 m/ 12 ft	Annual legume, viney stems, full sun	Cultivated as waterfowl food, occurs in most soils
River bulrush <sup>1</sup>	Rootstock	Sep-Apr	In sand beds or pots of sand	Apr-Jun	NE, MA, SE, CA	To 1.8 m/ 6 ft	Perennial, erect, widely spreading, seed head, full sun	Occurs in moist areas/interior U.S.
Saltmarsh bulrush <sup>1,2</sup>	Rootstock	Sep-Mar	In sand beds or pots of sand	Mar-Jun	MS, SP, CA, PNW	To 1.8 m/ 6 ft	Perennial, spiny seed, triangular stems, full sun	Prefers marshes, occurs on dredged material islands
Saltwort <sup>1</sup>	Transplants	Sep-Mar	In sand beds or in pots of sand	Mar-Jun	NE, MA, SE, FL	To 0.6 m/ 2 ft	Annual, spiny, much branched, gray leaves, full sun	Prefers coastal moist areas, tolerates brackish soils
Schweinitz's nutsedge <sup>1</sup>	Seeds	Aug-Oct	Dry, cool area	Apr-Jun	NE, GL, MRV, NP, MP	To 0.9 m/ 3 ft	Perennial, thickened corms, slender stems, full sun	Prefers sandy soils/moist areas
Sea blite <sup>1</sup>	Seeds	Jul-Sep	Dry, cool area	Mar-Jun	Entire U.S. in salt marshes	To 0.9 m/ 3 ft	Annual, much branched, full sun	Prefers coastal moist areas, tolerates salt spray
Sea ox-eye <sup>3</sup>	Seeds, transplants	Jul-Sep (seeds); Sep-Mar (trans.)	Dry, cool area (seeds) balled/burlapped (B&B) or potted (trans.)	Feb-May	Eastern and southern U.S. coasts	To 0.6 m/ 2 ft	Shrubby, fleshy, gray foliage, full sun	Occurs in sandy, coastal areas, tolerates salinity
Seashore lupine <sup>1</sup>	Seeds	May-Sep	Dry, cool area, soak in water before planting	Mar-Jun	PNW, CA	To 0.6 m/ 2 ft	Perennial, scrubby, full sun	Prefers sandy beaches/marshes
Seaside dock <sup>1</sup>	Seeds	Jul-Oct	Dry, cool area	Apr-Jun	Entire U.S. except SE, FL, MS	To 10 cm/ 4 in	Perennial, deep roots, erect, fast growing, full sun	Prefers moist sand areas, tolerates salt spray
Seaside goldenrod <sup>1</sup>	Seeds	Aug-Dec	Dry, cool area	Apr-Jun	Eastern and southern U.S. coasts	To 2.4 m/ 8 ft	Perennial, stout, erect, very leafy, large flower, full sun	Occurs on coasts/dredged material islands

(Sheet 15 of 35)

Table D-1 (Continued)

Species* (Alphabetized by Common Name)	Best Propagule Type	Collection Periods**	Temporary Storage Requirements**	Planting Periods**	Range†	Mature Height	Growth Habits	Remarks
<u>Herbs (Continued)</u>								
Seaside plantain <sup>1</sup>	Transplants, seeds	Mar-Oct (trans); Jun-Sep (seeds)	In sand beds or pots, dry, cool area	Mar-Jun	Entire coastal U.S.	To 20 cm/ 8 in	Annual/perennial, fleshy rootstock/stems, full sun	Prefers salt marshes/seashores, tolerates salinity
Sericea lespedza <sup>3</sup>	Seeds	Sep-Dec	Dry, cool area	Mar-Jun	FL, MP, MA, SE, MRV, SP, MS	To 0.9 m/ 3 ft	Woody perennial, dense fine foliage, good seed production, full sun	Occurs in moist soils, used on rights-of-ways, in pastures/ hay fields/conservation projects
Sheep sorrel <sup>1</sup>	Seeds	May-Jun	Dry, cool area	Feb-Apr	Entire U.S.	To 0.3 m/ 1 ft	Perennial, basal rosette, full sun	Grows in infertile acid soils, will die in fertile soils
Showy tick-trefoil <sup>1</sup>	Seeds (inoculated)	Jul-Sep	Dry, cool area	Apr-Jun	Eastern U.S.	To 1.5 m/ 5 ft	Perennial, erect, much branched, pubescent, shade or sun	Prefers rich soils, grows in woods or open areas
Silverleaf croton <sup>1</sup>	Seeds	Aug-Oct	Dry, cool area	Apr-Jun	FL, SE, MS	To 0.9 m/ 3 ft	Annual, many branched, silver leaves, full sun	Occurs in coastal soils, tolerates salt spray, tolerates drought
Southern bulrush <sup>1</sup>	Rootstock	Sep-Mar	In sand beds or pots of sand	Mar-Jun	SE, MS, FL, CA	To 3.7 m/ 12 ft	Perennial, triangular stems, upright, droopy spikelets, full sun	Occurs in coastal moist areas, tolerates brackish soils
Southern ragweed <sup>1</sup>	Seeds	Jul-Oct	Dry, cool area	Apr-Jun	SE, MS, SP	To 0.9 m/ 3 ft	Annual, hirsute, many branched, full sun	Occurs in dry upland soils, pest plant, occurs in waste areas
Soybean <sup>1,2,3</sup>	Seeds (inoculated)	Sep-Oct	Dry, cool area	Apr-Jul	Entire U.S.	To 0.6 m/ 2 ft	Annual, fast growing, high seed production, full sun	Cultivated extensively for beans, excellent wildlife food
Spotted burclover	Seeds (inoculated)	Feb-Apr (south); Apr-Jul (north)	Dry, cool area	Nov-Jan (south); Feb-May (north)	Entire U.S.	To 0.6 m/ 2 ft	Annual, spreading, stout, spiny seeds, full sun	In poor, dry soils
Spotted spurge <sup>1</sup>	Seeds	Jun-Nov	Dry, cool area	Apr-Jul	Entire U.S.	To 0.3 m/ 1 ft	Annual, branched stem, prostrate, spreading, full sun	Prefers dry soils

(Sheet 16 of 35)

Table D-1 (Continued)

Species* (Alphabetized by Common Name)	Best Propagule Type	Collection Periods**	Temporary Storage Requirements**	Planting Periods**	Range†	Mature Height	Growth Habits	Remarks
<u>Herbs (Continued)</u>								
Squarestem spikerush	Transplants, seeds	Apr-Jul (trans.); Jun-Aug (seeds)	In sand beds or pots (trans.), dry, cool area (seeds)	Mar-Jul	Entire U.S.	To 0.9 m/3 ft	Perennial, slender stems, square stems, full sun	Prefers moist areas, occurs on coasts in fresh water
Sunflower <sup>1</sup>	Seeds	Jul-Oct	Dry, cool area	Apr-Jun	Eastern and mid U.S.	To 3.7 m/12 ft	Perennial, fleshy roots, creeping rootstock, branching, full sun	Prefers moist areas, stems often purple, showy flowers
Tansy mustard <sup>1</sup>	Seeds	May-Jul	Dry, cool area	Mar-May	Entire U.S. except SW	To 0.6 m/2 ft	Annual, erect, branched, slender ascending branches, full sun	Prefers dry soils
Tropic croton <sup>1</sup>	Seeds	Aug-Oct	Dry, cool area	Apr-Jun	SE, FL, MS, SP, MA, MRV	To 1.8 m/6 ft	Annual, rough, hardy, full sun	Pest in pasture areas, occurs in moist soils
Tumble-weed <sup>1</sup>	Seeds	Jun-Sep	Dry, cool area	Mar-Jun	Entire U.S.	To 0.9 m/3 ft	Annual, pale green, erect, bushy branched	Occurs in most soils, prefers dry
Virginia pepperweed <sup>1</sup>	Seeds	May-Nov	Dry, cool area	Mar-Jun	Entire U.S. except CA, PNW	To 0.6 m/2 ft	Many branched, hardy, full sun	In dry soils, pest plant in fields, on many dredged material islands
Western ragweed <sup>1</sup>	Seeds	Sep-Nov	Dry, cool area	Apr-Jun	MW, CA, SW, NE, GL, NP, MP, SP	To 1.8 m/6 ft	Perennial, creeping rootstock, hardy, full sun	Prefers well-drained soils, a pest plant
White clover <sup>1,2,3</sup>	Seeds (inoculated)	Mar-May (south); May-Sep (north)	Dry, cool area	Jan-Mar (south); Mar-Jun (north)	Entire U.S. except MW	To 0.3 m/1 ft	Shallow rooted perennial with creeping branches, full sun	Cultivated as pasture/hay crops, occurs on moist soils
White sweetclover <sup>1</sup>	Seeds (inoculated)	Apr-May (south); Jun-Nov (north)	Dry, cool area	Nov-Feb (south); Mar-May (north)	Eastern U.S.	To 3 m/10 ft	Annual, erect or ascending, branching, full sun	Roadsides, pastures, lawns, occurs in moist soils
Wild bean <sup>1</sup>	Seeds (inoculated)	Sep-Oct	Dry, cool area	Mar-Jun	Eastern and mid-U.S.	To 2.7 m/9 ft	Summer annual legume, viney, full sun	Occurs on beaches, tolerates salt spray

(Sheet 17 of 35)

Table D-1 (Continued)

Species* (Alphabetized by Common Name)	Best Propagule Type	Collection Periods**	Temporary Storage Requirements**	Planting Periods**	Range†	Mature Height	Growth Habits	Remarks
<u>Herbs (Continued)</u>								
Wild buckwheat <sup>1</sup>	Seeds	Jun-Nov	Dry, cool area	Mar-Jun	Entire U.S.	To 0.9 m/ 3 ft	Annual, viney plant, rapid growth, full sun	Occurs in most soils, a pest plant in crops
Wild sensitive pea	Seeds (inoculated)	Jun-Nov	Dry, cool area	Mar-Jun	Entire U.S.	To 0.3 m/ 1 ft	Annual, erect, branching, full sun	Prefers dry soil
Wild strawberry	Seeds, transplants	Mar-May (south); May-Jul (north)	In sand beds (trans.) dry, cool area (seeds)	Sep-Feb	Eastern and mid U.S.	To 10 cm/ 4 in	Perennial, stout, slender stalks, shade or sun	Prefers dry, rich soil, edible berries
Woolly croton <sup>1,3</sup>	Seeds	Aug-Oct	Dry, cool area	Apr-Jun	MA, SE, MS, SP, MP, MRV	To 2.1 m/ 7 ft	Robust, branching annual, good seed production, full sun	Pest in pastures, grows in most soils, prefers sandy areas
Woolly indianwheat <sup>1</sup>	Seeds	May-Aug	Dry, cool area	Mar-Jun	MW, SP, NP, MP	To 0.3 m/ 1 ft	Annual, ascending leaves, slender stems, full sun	Prefers dry plains/prairies, other dry areas
Yellow starthistle <sup>1</sup>	Seeds	Jul-Sep	Dry, cool area	Apr-Jun	NE, MA, MRV, MW, CA	To 0.6 m/ 2 ft	Annual, branched, winged stems, full sun	Pest plant in cultivated areas
Yellow sweetclover <sup>1</sup>	Seeds (inoculated)	May-Jun (south); Jul-Nov (north)	Dry, cool area	Nov-Feb (south); Apr-Jun (north)	Eastern U.S.	To 0.3 m/ 1 ft	Annual, erect or ascending, branching, full sun	Occurs in waste areas/fields, most soils
<u>Vines</u>								
American bittersweet	Seeds	Sep-Nov	Dry, cool area	Mar-Jun	NE, MA, SP, SW, GL, MRV	To over 7.3 m/ 24 ft	Twining, woody vine, ascending trees or trailing on ground	Prefers rich, moist soil
Bamboo vine	Tubers, seeds	Sep-Mar (tubers); Jun-Sep (seeds)	In soil beds, dry, cool area	Feb-Jun	MA, SE, FL, MS, SP	Long trailing stems	Tuber rootstocks, stout, hardy, evergreen, spines, shade	Prefers moist areas in woods/thickets
(Sheet 18 of 35)								

Table D-1 (Continued)								
Species* (Alphabetized by Common Name)	Best Propagule Type	Collection Periods**	Temporary Storage Requirements**	Planting Periods**	Range†	Mature Height	Growth Habits	Remarks
<u>Vines (Continued)</u>								
Beach morning glory <sup>1</sup>	Stems, seeds	Sep-Apr	In sand beds, dry, cool area	Mar-Jun	Eastern U.S. and SP	To 3.7 m/12 ft	Perennial, twining, large roots	Prefers sandy beaches/dunes
Common greenbrier <sup>1</sup>	Seeds	May-Aug	Dry, cool area	Mar-Jun	Eastern and mid-U.S.	Long trailing stems	Woody, four-angled shoots, spiny, shade to sun	Prefers moist areas in woods/thickets, occurs in dry areas
Crossvine	Seeds	May-Aug	Dry, cool area	Mar-Jun	SE, MS, FL, MRV	To 18.3 m/60 ft	Woody, cross visible in cross section, shade or sun	Prefers moist woods, occurs in moist open areas
Fox grape <sup>1</sup>	Seeds	Aug-Sep	Remove pulpy coat; dry, cool area	Mar-Jun	MA, NE, MRV, SE	To 27.4 m/90 ft	Climbing, large stem, shade	Prefers thickets, native stock for cultivated grape hybrids
Fringed catbrier <sup>1</sup>	Tuber, seeds	Sep-Mar (tubers); Apr-Jul (seeds)	In soil beds (tubers) dry, cool area (seeds)	Apr-Jun	Eastern and mid-U.S.	Long trailing stems	Woody, four-angled, large tubers, spiny leaves/stems, shade or sun	Prefers thickets, moist areas, occurs in dry habitats
Frost grape <sup>1</sup>	Transplants	Jun-Oct	Remove pulpy coat; dry, cool area	Mar-Jun	NE, MA, SE, MW	Long trailing stems	Climbing, pubescent, thin shining leaves, shade or sun	Prefers moist rocky areas, occurs in open moist areas
Japanese honeysuckle <sup>1</sup>	Rootstock, transplants	Jun-Sep	Dry, cool area	Feb-Jun	Entire U.S.	Long climbing stems	Pubescent, fragrant, persistent, shade or sun	Pest plant in unkept areas, excellent forage plant
Kudzu <sup>3</sup>	Rootstock, transplants	Sep-Mar	In soil beds or pots of soil	Feb-Jun	Entire U.S.	Long climbing stems	Hairy, three-foliolate leaves, sun or shade	Pest plant in unkept areas, excellent cover vine, ornamental
Lanceleaf greenbrier	Seeds	Apr-Aug	Dry, cool areas	Mar-Jun	SE, FL, SP, MS	Long trailing stems	Woody, slender, no tubers or spines, shade or sun	Prefers dry thickets
Muscadine grape <sup>1,3</sup>	Seeds, transplants	Aug-Oct	Remove pulpy coat; dry, cool areas	Mar-Jun	SE, MA, FL, MP, MS, SP	Long trailing stems	Woody, slender stems, large leaves, shade or sun	Prefers moist sand soil in thickets, occurs in silt/clay in open

(Sheet 19 of 35)

Table D-1 (Continued)

Species* (Alphabetized by Common Name)	Best Propagule Type	Collection Periods**	Temporary Storage Requirements**	Planting Periods**	Range†	Mature Height	Growth Habits	Remarks
<u>Vines (Continued)</u>								
Peppervine <sup>1</sup>	Seeds	Sep-Oct	Dry, cool area	Mar-Jun	Entire U.S.	Long climbing stems	Numerous tendrils, aerial roots, fast growing, dense cover, sun or shade	Prefers wood/thickets, dry soil, but occurs in open areas
Sawbrier	Seeds	Sep-Mar (tubers); Jun-Aug (seeds)	In soil beds (trans.) dry, cool area (seeds)	Mar-May	Eastern U.S. and SP	Long trailing stems	Deep, tuberous rootstock, stout spines, shade or sun	Prefers dry sandy soil, also called sarsaparilla
Summer grape <sup>1</sup>	Seeds	Sep-Oct	Remove pulpy coat, dry cool area	Mar-Jun	SE, MS, FL	Long trailing vine	Evergreen, coarse stemmed, persistent, sun or shade	Prefers dry soil in woods, it occurs in open
Supplejack <sup>1</sup>	Seeds, transplants	May-Aug	Dry, cool area	Mar-Jun	ME, SE, FL, SP	High climbing stems	Shrub, tough, stout leaves/ stems	Prefers moist woods, but occurs in open areas
Virginia creeper <sup>1</sup>	Seeds	Aug-Oct	Remove pulpy coat; dry, cool areas	Mar-Jun	NE, MA, MRV, MS, SP, MP, NP	High climbing stems	Large leaves, bark loose/ shreddy, tendrils, shade or sun	Prefers dry soils in thickets, occurs in the open
Wild bamboo <sup>1</sup>	Seeds	Oct-Nov	Remove pulpy coat; dry, cool area	Mar-Jun	SE, MS, FL	Long trailing vine	Evergreen, coarse stemmed, persistent, sun or shade	Forms low thickets in the open or wood areas
<u>Shrubs and Small Trees</u>								
American elderberry <sup>1</sup>	Transplants, seeds	Sep-Mar; Jul-Sep	In nursery, dry cool place	Feb-Jun	Eastern and mid-U.S.	To 9.1 m/ 30 ft	Deciduous, many stemmed, large flowers, full sun	Prefers moist soils, but occurs over wide soil ranges
American hornbeam	Transplants	Sep-Mar	B&B or potted in nursery	Feb-Jun	Eastern and mid-U.S.	To 9.1 m/ 30 ft	Deciduous, round crown, partial or full shade	Prefers dry soils, often is understory in open woods
American plum <sup>1</sup>	Transplants, seeds	Sep-Mar; Jul-Sep (seeds)	B&B or potted in nursery; dry, cool place	Feb-Jun	Eastern and mid-U.S.	To 9.1 m/ 30 ft	Deciduous, spreading crown, full to partial sun	Prefers moist soils, occurs in dense thickets, edible fruit
Arrowwood viburnum	Transplants	Sep-Mar	B&B or potted in nursery	Feb-May	MS, SE	To 2.7 m/ 9 ft	Deciduous, shrubby, large flowers, partial sun	Prefers moist soils, common as understory
(Sheet 20 of 35)								



Table D-1 (Continued)

Species* (Alphabetized by Common Name)	Best Propagule Type	Collection Periods**	Temporary Storage Requirements**	Planting Periods**	Range†	Mature Height	Growth Habits	Remarks
<u>Shrubs and Small Trees (Continued)</u>								
Autumn olive <sup>1,2,3</sup>	Transplants	Sep-Mar	B&B or potted in nursery	Mar-Jun	MA, SE, MS, FL, SP	To 4.6 m/ 15 ft	Evergreen in south, deciduous in north, full sun, shrub, full to partial sun	Prefers dry soils, drought resistant, very hardy
Bayberry <sup>1</sup>	Transplants	Sep-Mar	B&B or potted in nursery	Feb-Jun	NE, MA	To 2.7 m/ 9 ft	Evergreen, very dense, full sun, shrub	Prefers sandy soils, occurs in coastal areas, common on dredged material, important habitat plant
Beach plum <sup>1</sup>	Transplants, seeds	Oct-Mar	B&B or potted in nursery	Feb-May	MA, NE	To 1.8 m/ 6 ft	Deciduous, low growing, many branched, full sun	Prefers sandy, coastal soils; edible fruit
Bearberry	Transplants, seedlings	Sep-Mar	B&B or potted in nursery, cleaned/stratified (seeds)	Feb-Jun	NE, MA, GL, MRV, NP, MW, CA, PNW	To 20 cm/ 8 in	Evergreen, spreading shrubby, slow growth, shade to full sun	Occurs in dry/sandy/rocky soils
Beautyberry <sup>1</sup>	Transplants, seeds	Sep-Mar	B&B or potted in nursery	Feb-Jun	SE, MS, FL, MA	To 2.4 m/ 8 ft	Deciduous, shrubby abundant fruit, full sun to partial shade	Grows in variety of soil conditions, does best as understory plant
Bicolor lespedeza	Transplants	Sep-Nov Mar-Jun	B&B or potted in nursery	Mar-Jun	MA, SE, FL, SP	To 2.7 m/ 9 ft	Deciduous legume, irregular shrub, full sun	Tolerates poor soils/drought conditions, prefers well-drained, dry areas
Black raspberry <sup>1</sup>	Transplants	Sep-Mar	Potted in nursery or soil bed	Feb-Jun	NE, MA, SE, SP, MP	To 3.7 m/ 12 ft	Deciduous, spiny, glaucous, roots from stem tips, full sun	Occurs in most soils, persistent, pest plant in pastures
Blue brush	Seeds	Jun-Aug	Dry, cool area	Feb-Jun	PNW, CA	To 0.9 m/ 3 ft	Deciduous, shrubby, shade to sun	Occurs in dry, rocky, sandy areas, used for tea substitute by pioneers
Blue elderberry	Seeds	Jul-Oct	Cleaned/stratified seeds	Feb-Jun	SW, CA, PNW	To 7.6 m/ 25 ft	Deciduous, many stemmed, showy flowers, full sun	Occurs in most soils in open or in edges of woods
Brazilian peppertree <sup>1</sup>	Cuttings, transplants	Oct-Apr	In rooting medium (cuttings), B&B or potted (trans.)	Oct-Jun	FL	To 9.1 m/ 30 ft	Evergreen, many branched, tropical, showy flowers, full sun	Occurs in most soils below freeze line in Florida, common on dredged material islands
Brewer saltbush	Seeds	Jun-Sep	Dry, cool area	Feb-Jun	CA, SW	To 0.6 m/ 2 ft	Shrubby, dense, full sun	Occurs in dry, saline soil, also known as sage brush

(Sheet 21 of 35)

Table D-1 (Continued)

Species* (Alphabetized by Common Name)	Best Propagule Type	Collection Periods**	Temporary Storage Requirements**	Planting Periods**	Range†	Mature Height	Growth Habits	Remarks
<u>Shrubs and Small Trees (Continued)</u>								
Buffaloberry <sup>1</sup>	Seeds	Jul-Sep	Cleaned/stratified	Mar-Jun	NE, MA, GL, NP, SW	To 2.4 m/8 ft	Deciduous, shrubby, shade to sun	Occurs in moist soils
Bush lupine	Seeds	Jul-Sep	Dry, cool area	Mar-Jun	PNW, CA	To 0.6 m/2 ft	Perennial, shrubby, many seed pods, full sun to part shade	Occurs in dry/well-drained soils, both in open and in edges of woods
California blackberry <sup>1</sup>	Seeds, transplants	Sep-Apr (trans.); Jun-Jul (seeds)	B&B or potted in nursery (trans.) cleaned/stratified (seeds)	Feb-May	PNW, CA	To 0.9 m/3 ft	Perennial, woody, many branched, arching, full sun	Occurs in dry, well-drained areas in most soils, very dense wood
California buckthorn	Transplants	Sep-Mar	B&B or potted in nursery	Feb-May	PNW, CA	To 1.8 m/6 ft	Deciduous, shrubby, thorny, full sun	Occurs in dry soils
Canadian serviceberry <sup>1</sup>	Seeds, transplants	Sep-Apr (trans.); May-Jun (seeds)	B&B or potted in nursery (trans.) cleaned/stratified (seeds)	Mar-Jun	SE, NE, MA	To 6.4 m/21 ft	Deciduous, upright, shrubby, pubescent young twigs, full to partial sun	Prefers moist areas, occurs in most soils
Carolina ash	Transplants	Sep-Mar	B&B or potted in nursery	Mar-Jun	MA, SE, FL, MP, MS, SP	To 13.7 m/45 ft	Deciduous, pubescent, five to seven leaflets, shade or sun	Occurs in moist or wet soils, in woods or in open
Carolina rose <sup>1</sup>	Hips, cuttings	Jul-Oct (hips); Apr-Oct (cuttings)	Cleaned/stratified (hips), in rooting medium (cuttings)	Feb-Jun	Eastern and mid U.S.	To 1.5 m/5 ft	Deciduous, thorny, arching, fast growing, full sun	Occurs in most soils, well-drained to dry, open areas
Cascara buckthorn <sup>1</sup>	Seeds	Jul-Sep	Cleaned/stratified	Apr-Jun	PNW, CA	To 6.4 m/21 ft	Deciduous, shrubby, shade to full sun	Occurs in most soils, open areas or in woods
Cherry laurel <sup>1,3</sup>	Transplants, cuttings	Sep-Mar	B&B or potted in nursery	Mar-Jun	SE, MS, MA	To 9.1 m/30 ft	Evergreen, shrubby, ascending branches, full sun to partial shade	Occurs in most soils, cultivated as an ornamental
Chickasaw plum <sup>1</sup>	Seeds	Jun-Jul	Cleaned/stratified	Feb-May	SE, MS, MA, SP	To 1.8 m/6 ft	Deciduous, shrubby, thorny, large fruit, full sun	Ferns, thickets, occurs in most dry/well-drained soils
Common buckthorn	Transplants	Sep-Mar	B&B or potted in nursery	Feb-Jun	SE, FL, MS, SP	To 9.1 m/30 ft	Deciduous, shrub or tree, few seeds, shade or sun	Prefers moist soils, in open or edges of woods

Table D-1 (Continued)								
Species* (Alphabetized by Common Name)	Best Propagule Type	Collection Periods**	Temporary Storage Requirements**	Planting Periods**	Range†	Mature Height	Growth Habits	Remarks
<u>Shrubs and Small Trees (Continued)</u>								
Common chokecherry <sup>1</sup>	Seeds	Aug-Sep	Cleaned/stratified	Mar-Jun	MS, MRV, GL, MP, MW, SW, PNW, CA	To 9.1 m/30 ft	Deciduous, shrubby underground stems, forms thickets, shade or sun	Occurs in most soils including sand dunes/rocky areas
Common deerberry	Transplants, seeds	Sep-Mar (trans.); Apr-Jun (seeds)	B&B or potted, cleaned/stratified	Feb-May	Eastern U.S.	To 1.8 m/6 ft	Deciduous, much branched, irregular, shade or sun	Occurs in dry soils in woody thickets and in edges of woods
Common juniper <sup>1</sup>	Seeds, seedlings	Sep-Mar (seedlings); Sep-Nov (seeds)	B&B or potted in nursery, stratified at 5°C	Mar-Jun	GL, MS, SE	To 3.7 m/12 ft	Spreading, narrowleaf evergreen shrub, full sun	Used as an ornamental shrub over a large range, quite hardy, tolerates alkaline soils
Common sweetleaf <sup>1</sup>	Transplants	Sep-Mar	B&B or potted in nursery	Feb-May	MA, SE, MS	To 2.7 m/9 ft	Deciduous, large waxy leaves, sweet taste, shade or sun	Occurs in woody areas/thickets, mostly in shade, sometimes in open areas
Crabapple <sup>1</sup>	Transplants, seeds	Sep-Mar (trans.); May-Jul (seeds)	B&B or potted (trans.) cleaned/stratified (seeds)	Feb-May	MA, SE, FA, MS	To 6.4 m/21 ft	Deciduous, thorny, bitter fruit, showy flowers, full sun	Occurs in most dry soils, in open thickets
Dahoon <sup>1</sup>	Transplants	Oct-Mar	B&B or potted in nursery	Feb-May	SE, FL, MS	To 7.6 m/25 ft	Evergreen, thorny, slow growing, full sun	Prefers sandy moist areas, in woods or open, in coastal areas
Downy serviceberry	Transplants	Sep-Mar	B&B or potted in nursery	Feb-Jun	SE, MS	To 13.7 m/45 ft	Deciduous, large leaves, pubescent, shade or sun	Prefers dry soils, in woods or open areas
Eastern hophornbeam <sup>1</sup>	Transplants	Sep-Mar	B&B or potted in nursery	Feb-Jun	NE, GL, MP, SP, MRV, SE, MA, FL, MS	To 10 m/33 ft	Deciduous, hardwood, leaves yellow-green, shade or sun	Prefers dry soils, in woods or in open areas
Elderberry <sup>1</sup>	Seeds	Jun-Aug	Cleaned/stratified	Feb-Jun	MW, PNW, CA, SW	To 7 m/23 ft	Deciduous, large seed-heads, few branches	Occurs in dry soils
(Sheet 23 of 35)								

Table D-1 (Continued)

Species* (Alphabetized by Common Name)	Best Propagule Type	Collection Periods**	Temporary Storage Requirements**	Planting Periods**	Range†	Mature Height	Growth Habits	Remarks
<u>Shrubs and Small Trees (Continued)</u>								
Evergreen blackberry <sup>1</sup>	Seeds	Jun-Jul	Cleaned/replanted	Aug-Sep	Eastern U.S.	To 4 m/ 13.1 ft	Stout, deciduous, arching branches, persistent	Pest plant in pastures, cultivated for fruit
Firethorn <sup>3</sup>	Seeds, transplants	Sep-Jan (seeds); Sep-Mar (trans.)	Cleaned/stratified (seeds), B&B or potted	Feb-May	MA, SE, SP, FL, MS	To 4 m/ 13.1 ft	Evergreen, irregular, hardy, showy flowers/fruit, full sun	Occurs in most soils, grows well in wet or dry areas, cultivated as ornamental
Flowering dogwood <sup>1</sup>	Transplants	Oct-Feb	B&B or potted in nursery	Feb-Apr	Eastern U.S. and SP	To 15 m/ 49.2 ft	Deciduous, bushy crown, showy flowers, shade or sun	Occurs in dry soils, cultivated as ornamental, in woods or in open areas
Gallberry <sup>1</sup>	Transplants	Oct-Mar	B&B or potted in nursery	Feb-May	NE, MA, SE, FL, MS	To 2 m/ 6.6 ft	Evergreen, shrubby, dotted underside of leaves, shade or sun	Prefers sandy soil, occurs on coasts
Gray dogwood <sup>1</sup>	Transplants	Sep-Mar	B&B or potted in nursery	Feb-May	Eastern and mid-U.S.	To 2 m/ 6.6 ft	Dense deciduous, shrubby, gray bark, shade or sun	Prefers moist soils, occurs in thickets, woods, open areas
Ground blueberry <sup>1</sup>	Seeds	May-Jun	Cleaned/stratified	Jan-Mar	SE, MS, MA	To 2 m/ 6.6 ft	Evergreen, pubescent, few branches, shade or sun	Prefers moist areas, in woods or in open areas
Groundsel tree <sup>1</sup>	Seeds, transplants	Sep-Nov	B&B or potted (trans.) dry, cool area (seeds)	Jan-May	SE, MA, MS, SP, NE	To 3.5 m/ 11.5 ft	Many branched, deciduous, shrubby, full sun	Prefers moist areas, occurs on sea coasts, tolerates salinity
Halberd-leaved willow <sup>1,3</sup>	Transplants	Sep-Mar	B&B or potted	Feb-Jun	Entire U.S.	To 10 m/ 32.9	Many branched, deciduous, full sun	Cultivated as ornamental
Hibiscus <sup>1</sup>	Seeds, transplants	Sep-Mar (trans.); Jun-Aug (seeds)	B&B or potted (trans.) dry, cool area (seeds)	Feb-Jun	NE, SE, MA, FL, MS, SP	To 2.3 m/ 7.5 ft	Deciduous, many branched, erect, large seed pods, full sun	Prefers moist soils, tolerates some salinity, occurs on coasts/inland
Highbush blueberry <sup>1,3</sup>	Seeds, cuttings	Jan-Feb (trans.); Jun-Aug (seeds)	Cooled/cleaned/planted (seeds) layered in rooting medium (trans.)	Feb-Jun	NE, SE, MA, FL, MS	To 4 m/ 13.1 ft	Deciduous, erect, hardy, many branched, shade to full sun	Occurs in moist soils

Table D-1 (Continued)

Species* (Alphabetized by Common Name)	Best Propagule Type	Collection Periods**	Temporary Storage Requirements**	Planting Periods**	Range†	Mature Height	Growth Habits	Remarks
<u>Shrubs and Small Trees (Continued)</u>								
Hollyleaf cherry	Seeds, transplants	Jul-Sep	Cleaned/stratified	Nov-May	CA	To 8 m/ 26.2 ft	Evergreen, serrated holly-like leaves, full sun	Prefers dry soils
Honey mesquite <sup>1</sup>	Seeds	Aug-Sep	Dry, cool area	Feb-May	SP, SW	To 14 m/ 45.9	Deciduous, shrubby, thorny, irregular crown, full sun	Prefers dry/sandy/loam soils, pest plant in western pastures
Hooker= <sup>s</sup> willow <sup>1</sup>	Cuttings	Year-round	Layered in rooting medium	Feb-Jun	PNW, CA	To 10 m/ 32.9 ft	Deciduous, shrubby pubescent, full sun	Prefers moist areas, tolerates shifting sand/flooding
Japanese lespedeza	Seeds, inoculated	May-Sep	Dry, cool area	Feb-Jun	Entire U.S.	To 1 m/ 3.3 ft	Shrubby, woody perennial, full sun	Cultivated for grazing
Low blueberry	Seeds	Jun-Jul	Cleaned/stratified	Oct-May	SE, MA, MS	To 0.6 m/ 2 ft	Shrubby, erect, rhizomous, stout, shade or sun	Prefers dry areas/thickets/woods
Mapleleaf viburnum	Seeds	Jul-Oct	Cleaned/stratified	Feb-May	SE, MS, MA	To 0.9 m/ 3 ft	Deciduous, shrubby, maple shape leaf, shade or sun	Thickets or open areas
Marsh elder <sup>1</sup>	Transplants	Oct-Apr	B&B or potted in nursery	Feb-May	NE, MA, SE, FL, MS, SP	To 3.7 m/ 12 ft	Deciduous, many branched, serrated leaves, full sun	Prefers sandy, moist areas, occurs on coastal islands/dunes/marshes
Mountain blackberry	Seeds, rootstock	Jun-Jul (seeds); Year-round (rootstock)	Cleaned/replanted (seeds), in soil beds (rootstock)	Sep-Nov (seeds); Feb-May (rootstock)	NE, MA, GL, MRV	To 3 m/ 10 ft	Deciduous, hardy, very robust, prolific fruiting, full sun, spiny	Pest plant in pastures, occurs/ thrives almost anywhere
Multiflora rose <sup>1,3</sup>	Transplants	Sep-Mar	B&B or potted in nursery	Feb-Jun	Entire U.S. except NP	To 3.7 m/ 12 ft	Deciduous, arching, thorny, showy flowers, full sun	Pest plant in unkept pastures/ fields, cultivated for windbreaks/cover
Myrtle oak	Transplants	Oct-Mar	B&B or potted in nursery	Oct-Mar	FL	To 13.7 m/ 45 ft	Evergreen, leathery, full sun	Prefers sandy coastal soils, tolerates salt spray
Northern bayberry <sup>1</sup>	Transplants	Oct-Mar	B&B or potted in nursery	Feb-Jun	NE, MA	To 13.7 m/ 45 ft	Evergreen, pubescent, dense, dark green, full sun	Prefers sandy coastal soils, tolerates salt spray
Oleander <sup>1,2,3</sup>	Transplants	Oct-Mar	B&B or potted in nursery	Feb-Apr	SW, FL, MS	To 9.1 m/ 30 ft	Evergreen, dense, upright stems, showy flowers, full sun	Prefers dry sand soils, tolerates salt spray/drought, not freeze tolerant

(Sheet 25 of 35)

Table D-1 (Continued)

Species* (Alphabetized by Common Name)	Best Propagule Type	Collection Periods**	Temporary Storage Requirements**	Planting Periods**	Range†	Mature Height	Growth Habits	Remarks
<u>Shrubs and Small Trees (Continued)</u>								
Pacific bayberry	Transplants	Sep-Mar	B&B or potted in nursery	Mar-Jun	PNW, CA	To 8.2 m/ 27 ft	Evergreen, shrubby, dense foliage, full sun	Prefers sand sites, occurs in coastal areas, tolerates salt spray
Pacific dogwood <sup>1</sup>	Transplants	Sep-Mar	B&B or potted in nursery	Feb-Jun	PNW, CA	To 2.7 m/ 9 ft	Deciduous, shrubby, erect, bushy, full sun/shade	Prefers well-drained areas
Pacific wax myrtle	Transplants	Oct-Feb	B&B or potted in nursery	Feb-May	PNW, CA, coasts	To 10.7 m/ 35 ft	Evergreen, thick shrubs, ascending branches, full sun	Prefers moist areas, occurs in marshes, gullies, sand dunes, islands
Pacific willow <sup>1</sup>	Cuttings, transplants	Year-round (cut.); Sep-Mar (trans.)	In rooting medium (cut.), B&B or in pots (trans.)	Feb-May	PNW, CA	To 3.7 m/ 12 ft	Deciduous, shrubby, fast growing, full sun	Prefers moist areas
Poison ivy <sup>1</sup>	Transplants	Sep-Mar	B&B or in pots in nursery	Feb-Jun	Entire U.S.	To 4.6 m/ 15 ft	Deciduous, fast growing, full sun	Prefers moist areas, vine form not recommended for planting
Possumhaw <sup>1,3</sup>	Seeds	Sep-Dec	Cleaned/stratified	Mar-Jun	GL, SP, MP, MRV, SE, MS, MA, FL	To 9.1 m/ 30 ft	Deciduous, red berries, very showy, shade or sun	Prefers moist areas, cultivated as ornamental
Possumhaw viburnum	Seeds	Aug-Oct	Cleaned/stratified	Mar-Jun	SE, MS, MA, FL	To 7.6 m/ 25 ft	Deciduous, large leaves, shade or sun	Occurs in moist soils, in woods or in open
Purple osier willow	Transplants, cuttings	Sep-Mar	In rooting medium, or potted	Mar-Jun	MA, MRV, NE	To 3.7 m/ 12 ft	Deciduous, purple stems, slender, full sun	Cultivated as an ornamental, prefers moist places, used in bank stabilization
Pussy willow <sup>3</sup>	Transplants, cuttings	Sep-Mar	B&B or potted in nursery	Mar-Jun	NE, NP, GL	To 7.3 m/ 24 ft	Deciduous, shrubby, full sun	Prefers moist soils, widely used as an ornamental
Quail brush	Seeds	Jul-Oct	Dry, cool area	Mar-May	SW	To 0.9 m/ 3 ft	Deciduous, shrubby, pale green, full sun	Prefers dry, sandy soils; tolerates salinity
Red alder <sup>1</sup>	Transplants, cuttings	Year-round (cut.); Sep-Mar (trans.)	In rooting medium (cut.), B&B or in pots (trans.)	Feb-May	PNW, CA	To 13.7 m/ 45 ft	Deciduous, shrubby, upright branches, full sun	Occurs on most soils, on cutover forest land, beaches, streams

Table D-1 (Continued)

Species* (Alphabetized by Common Name)	Best Propagule Type	Collection Periods**	Temporary Storage Requirements**	Planting Periods**	Range†	Mature Height	Growth Habits	Remarks
<u>Shrubs and Small Trees (Continued)</u>								
Red buckeye	Transplants, seeds	Aug-Oct (seeds); Sep-Mar (trans.)	Stratified (seeds), B&B or in pots	Feb-May	SE, MS, SP	To 7.3 m/ 24 ft	Deciduous, shrubby, shade or sun	Large fruit is inedible, occurs in most soils
Red osier dogwood <sup>1,3</sup>	Cuttings, transplants	Aug-Apr (cut.); Sep-Apr (trans.)	In rooting medium B&B or potted	Apr-Jun	NE, MRV, GL, NP, SW, PNW, MW	To 2.4 m/ 8 ft	Deciduous, shrubby stoloniferous, full to partial sun	Occurs in moist soils, prefers moist, poorly drained areas
Riverflat hawthorn	Seeds	Apr-Jun	Cleaned/stratified	Mar-May	SE, MA, MS	To 4.6 m/ 15 ft	Deciduous, leathery, thorny, shade or sun	Prefers dry soils, in woods or in open, red fruit
Rough-leaved dogwood <sup>1</sup>	Transplants	Sep-Mar	B&B or potted	Feb-May	SE, MA, MS, SP, NP, MP	To 4.6 m/ 15 ft	Deciduous, showy flowers, fast growing, sun or shade	Prefers moist areas, occurs in most soils
Russian olive <sup>1,2,3</sup>	Seeds, transplants	Sep-Oct (seeds); Sep-Mar (trans.)	Cleaned/stratified (seeds), B&B or potted (trans.)	Mar-Jun	Entire U.S.	To 6.4 m/ 21 ft	Evergreen, shrubby, spiny, irregular crown, full sun	Occurs in most soils, cultivated for wind break, roadside, ornamental
Rusty blackhaw	Seeds	Jul-Oct	Cleaned/stratified	Feb-Apr	SE, MS, MA, FL	To 2.7 m/ 9 ft	Deciduous, leathery, shiny green, shade	Prefers dry areas, in woods, but occurs in thickets/open areas
Salal <sup>1,3</sup>	Transplants, root stock	Sep-Mar	B&B or potted in nursery	Feb-Jun	PNW, CA	To 1.8 m/ 6 ft	Evergreen, dark shiny leaves, shade	Prefers moist areas, cultivated for florist industry
Salmonberry <sup>1</sup>	Seeds	Jun-Aug	Cleaned and in dry cool area	Mar-Jun	PNW	To 4.6 m/ 15 ft	Deciduous, branching, leafy, shrubby, showy flowers, large fruit, shade	Occurs in moist areas, in woods/thickets
Saltbush <sup>1</sup>	Seeds	Jul-Oct	Dry, cool area	Feb-May	SW	To 0.9 m/ 3 ft	Deciduous, shrubby, pale green, full sun	Prefers dry, sandy soils, tolerates drought/salinity
Saltcedar <sup>1,3</sup>	Transplants	Oct-Mar	B&B or potted in nursery	Feb-May	MA, SW, SP, MS, FL	To 4.6 m/ 15 ft	Evergreen, small foliage, irregular crown, full sun	Prefers dry, sandy soils, tolerates drought/salinity
Sandbar willow <sup>1,3</sup>	Transplants, cuttings	Sep-Mar	B&B or potted in nursery	Mar-Jun	NE, MRV, GL, MP, SP, MW	To 8.2 m/ 27 ft	Deciduous, shrubby, dense, full sun	Prefers moist soils, riverbanks

(Sheet 27 of 35)

Table D-1 (Continued)

Species* (Alphabetized by Common Name)	Best Propagule Type	Collection Periods**	Temporary Storage Requirements**	Planting Periods**	Range†	Mature Height	Growth Habits	Remarks
<u>Shrubs and Small Trees (Continued)</u>								
Sand blackberry <sup>1</sup>	Seeds	May-Jul	Cleaned/stratified	Feb-Jun	MA, SE, FL	To 0.9 m/ 3 ft	Deciduous, arching, erect, spiny, robust, full sun	Prefers dry, sandy areas
Sand pine <sup>1,2,3</sup>	Transplants, seedlings	Oct-Mar	B&B or potted in nursery	Feb-May	FL, MS	To 5.5 m/ 18 ft	Narrowleaf evergreen, shrubby, full sun	Grows in poor soils, tolerates droughty, sandy conditions, occurs on coasts
Sawtooth oak <sup>1,2,3</sup>	Transplants	Sep-Mar	B&B or potted in nursery	Feb-May	SE, MS, FL, SP	To 9.1 m/ 30 ft	Deciduous, irregular growth, full sun	Cultivated for wildlife food, occurs on most soils
Scotch broom <sup>1,3</sup>	Transplants	Sep-Mar	B&B or potted in nursery	Feb-May	PNW	To 2.1 m/ 7 ft	Evergreen showy flowers, dense growth, full sun	Pest plant in some areas, cultivated as ornamental elsewhere
Sharp-toothed blackberry <sup>1</sup>	Rootstock, seeds	Year-round (root); Jun-Jul (seeds)	In soil beds (root.) cleaned/stratified (seeds)	Sep-Nov (seeds); Feb-May (root-stock)	SE, ME, FL, MS, MRV	To 1.8 m/ 6 ft	Deciduous, hardy, very robust, prolific fruiting, full sun, spiny	Pest plant in pastures, occurs/thrives almost anywhere
Shining sumac <sup>1</sup>	Seeds, rootstock	Sep-Nov; Sep-Mar	Cleaned/stratified (seeds), in soil beds (rootstock)	Feb-Jun	Eastern and mid-U.S.	To 3.7 m/ 12 ft	Deciduous, little branching, lateral spreading roots, forms thickets, full sun	Occurs in moist soils, in open areas
Shore pine <sup>1,3</sup>	Transplants, cuttings	Sep-Mar	B&B or potted in nursery	Feb-May	PNW, CA	To 11 m/ 36 ft	Narrowleaf evergreen, spreading, full sun	Coastal dunes plant, very hardy, can be grown from seeds
Shrub verbena <sup>1,3</sup>	Seeds, transplants	May-Sep (seeds); Sep-Mar (trans.)	Dry, cool area (seeds) B&B or potted (trans.)	Jan-Apr	FL, SE, MS, SP	To 0.9 m/ 3 ft	Deciduous, tropical, showy flowers, full sun	Cultivated as ornamental, prefers moist, sandy soils
Silky dogwood <sup>1</sup>	Transplants	Sep-Mar	B&B or potted	Feb-Jun	Eastern and mid-U.S.	To 3 m/ 10 ft	Deciduous, purplish stems, full sun	Prefers moist soils, in woods/in open areas
Silky willow <sup>1</sup>	Transplants, cuttings	Year-round (cut.); Sep-Mar (trans.)	In rooting medium, B&B or potted (trans.)	Mar-Jun	NE, MA, GL, MRV	To 3.7 m/ 12 ft	Deciduous, purplish stems, pubescent, full sun	Prefers wet to moist soils, in open areas



Table D-1 (Continued)								
Species* (Alphabetized by Common Name)	Best Propagule Type	Collection Periods**	Temporary Storage Requirements**	Planting Periods**	Range†	Mature Height	Growth Habits	Remarks
<u>Shrubs and Small Trees (Continued)</u>								
Sitka alder <sup>1</sup>	Transplants, cuttings	Year-round (cut.); Sep-Mar (trans.)	In rooting medium, B&B or potted (trans.)	Feb-May	PNW	To 9.1 m/30 ft	Deciduous, shrubby, multi-stemmed, full sun	Prefers moist soils, in open areas
Smooth sumac <sup>1</sup>	Seeds	Sep-Feb	Cleaned/stratified	Feb-Jun	Entire U.S.	To 1.8 m/6 ft	Deciduous, shrubby, few branches, forms thickets from roots, full sun	Occurs in most soils, in open areas
Southern bayberry <sup>1</sup>	Transplants	Sep-Mar	B&B or potted	Feb-May	SE, MA, FL, MS, SP	To 4.6 m/15 ft	Evergreen, dense, upright branches, full sun	Prefers moist, sandy areas, occurs on seacoasts/islands
Southern dewberry <sup>1</sup>	Seeds, transplants	Apr-May (seeds); Year-round (trans.)	Cleaned/stratified (seeds), B&B or potted (trans.)	Jan-Mar	SE, MS, FL, SP	To 0.9 m/3 ft	Deciduous, persistent, large fruit, full sun	Occurs in most soils, excellent wildlife food
Sparkleberry	Seeds	May-Jul	Cleaned/stratified	Jan-May	SE, MA, SP, MS	To 9.1 m/30 ft	Deciduous in north, evergreen in south, sprawling, shrubby, shade or full sun	Occurs in dry soils, in woods or open thickets
Squaw huckleberry	Seeds	May-Jun	Cleaned/stratified	Feb-Jun	Eastern and mid-U.S.	To 4.6 m/15 ft	Deciduous, leathery, shrubby, shade or sun	Occurs in dry woods or open thickets, edges of woods
Staghorn sumac <sup>1</sup>	Seeds	Oct-Dec	Cleaned/stratified	Feb-May	Eastern and mid-U.S.	To 3.7 m/12 ft	Deciduous, few branches, showy fruit, full sun	Forms thicket, occurs in dry soils
Summersweet	Seeds	Sep-Nov	Cleaned/stratified	Feb-May	SE, MS	To 1.5 m/5 ft	Deciduous, ascending stems, pubescent, shade or sun	Occurs in most soils, in woods/open areas, cultivated as ornamental
Swamp privet <sup>1</sup>	Transplants	Sep-Mar	B&B or potted	Feb-May	SE, MS	To 7.3 m/24 ft	Deciduous, many branches, shrubby, shade or sun	Prefers moist, bottomland type soils (silt, clay)
Swamp rose <sup>1</sup>	Transplants	Sep-Mar	B&B or potted	Feb-Jun	MA, SE, MS	To 0.9 m/3 ft	Deciduous, arching branches, full sun	Prefers moist soils

(Sheet 29 of 35)

Table D-1 (Continued)

Species* (Alphabetized by Common Name)	Best Propagule Type	Collection Periods**	Temporary Storage Requirements**	Planting Periods**	Range†	Mature Height	Growth Habits	Remarks
<u>Shrubs and Small Trees (Continued)</u>								
Tag alder <sup>1</sup>	Transplants, cuttings	Year-round (cut.); Sep-Mar (trans.)	In rooting medium, B&B or potted	Feb-May	NE, MA, MS, SP, MRV	To 4.6 m/15 ft	Deciduous, rusty, pubescent, shade or sun	Occurs in moist soils, in woods or in open areas
Tartarian honeysuckle <sup>1</sup>	Transplants, rootstock	Sep-Mar	B&B, potted or in soil beds	Feb-Jun	Entire U.S.	To 1.8 m/6 ft	Deciduous, showy flowers, full sun	Cultivated as ornamental shrub
Texas huisache <sup>1</sup>	Seeds	Aug-Oct	Dry, cool area	Jan-Apr	SP, MS, SW	To 4.6 m/15 ft	Deciduous, large seed pods, full sun	Prefers dry, sandy soils, tolerates drought/salinity
Thorny eleagnus <sup>1,3</sup>	Transplants, cuttings	Sep-Apr	B&B or potted in nursery	Mar-Jun	Entire U.S.	To 3.7 m/12 ft	Evergreen, robust, thorny, spreading, arching, full sun	Cultivated as ornamental, tolerates poor soil/salt spray
Toothache tree <sup>1</sup>	Transplants	Sep-Mar	B&B or potted in nursery	Feb-May	SE, FL, MS, SP	To 11 m/36 ft	Deciduous, fast growing, spiny, full or partial sun	Prefers well-drained soils, occurs on dredged material in Texas/North Carolina
Turkey oak <sup>1</sup>	Transplants, cuttings	Sep-Mar	B&B or potted in nursery	Feb-May	SE, MA, FL	To 9.1 m/30 ft	Deciduous, large leathery leaves, full sun	Prefers sandy coastal areas
Wax myrtle <sup>1,3</sup>	Transplants	Oct-Mar	B&B or potted in nursery	Mar-Jun	SE, FL, MS, MA, SP	To 3 m/10 ft	Evergreen, dense, shrubby, ascending branches, full sun	Prefers moist areas, does well on poor, sandy coastal sites
Western blackberry <sup>1</sup>	Transplants	Sep-Mar	B&B or potted	Feb-Jun	PNW, CA	To 0.9 m/3 ft	Arching, deciduous, full sun	Occurs in dry soils, pest plant in pastures
Western chokecherry	Seeds	Aug-Sep	Cleaned/stratified	Feb-May	CA, PNW	To 7.3 m/24 ft	Deciduous, bushy, full sun	Occurs in most soils, smells bad
Western dogwood	Transplants	Sep-Mar	B&B or potted	Feb-May	PNW, CA	To 4.6 m/15 ft	Deciduous, irregular branches, shade or sun	Occurs in most soils, in woods or in open areas
Western huckleberry	Transplants	Sep-Mar	B&B or potted in nursery	Feb-Jun	PNW, CA	To 2.4 m/8 ft	Evergreen, erect, slow growth, shade to sun	Occurs in dry woods
Wild apple <sup>1</sup>	Seeds, transplants	Aug-Oct (seeds); Sep-Mar (trans.)	Cleaned/stratified, B&B or potted	Feb-May	Entire U.S.	To 6.4 m/21 ft	Deciduous, thorny, showy flowers, large fruit, full sun	Occurs in most soils, parent stock of all commercial apple trees

Table D-1 (Continued)								
Species* (Alphabetized by Common Name)	Best Propagule Type	Collection Periods**	Temporary Storage Requirements**	Planting Periods**	Range†	Mature Height	Growth Habits	Remarks
<u>Shrubs/Small Trees (Continued)</u>								
Wild black currant <sup>1</sup>	Transplants	Sep-Mar	B&B or potted	Feb-Jun	Northern U.S.	To 0.9 m/ 3 ft	Deciduous, arching erect branches	Occurs in most soils
Wild cherry <sup>1</sup>	Seeds	Aug-Sep	Cleaned/stratified	Feb-Jun	PNW, CA, SW	To 9.1 m/ 30 ft	Deciduous, bitter fruit, full sun	Occurs in most soils
Wild indigo <sup>1</sup>	Seeds, transplants	Sep-Oct	Dry, cool area (seeds) B&B or potted (trans.)	Jan-Mar	SP, MS, SE	To 0.9 m/ 3 ft	Deciduous, tumbles, seed-pods rattle, full sun	Occurs in dry soils, prefers sand or silt, tolerant of salt spray
Wild rose <sup>1,3</sup>	Transplants, cuttings	Sep-Mar	B&B or potted in nursery (trans.) in rooting medium (cuttings)	Feb-Jun	MA, SE, MS, SP, FL	To 4.6 m/ 15 ft	Deciduous, arching branches, thorns, profuse flowers, full sun	Prefers moist soils, fast growing, tolerant of wide range of soil conditions
Wingscale	Seeds	Nov-Dec	Dry, cool place	Jan-May	MW, SW, CA	To 2.4 m/ 8 ft	Evergreen, shrubby, much branched, full sun	Tolerates drought/wide range of soil conditions, prefers dry sandy soil
Winterberry <sup>3</sup>	Transplants	Sep-Mar	B&B or potted in nursery	Mar-Jun	SE, MS	To 4.6 m/ 15 ft	Deciduous, arching, rounded crown, full sun or shade	Wide range of soil conditions, prefers moist soils
Witch hazel	Transplants	Sep-Mar	B&B or potted in nursery	Feb-May	NE, MA, SE, MS, MP, GL, MRV	To 9.1 m/ 30 ft	Deciduous, shrubby, partial sun to full shade	Prefers moist soils
Yaupon <sup>1,3</sup>	Transplants	Oct-Mar	B&B or potted in nursery	Jan-Apr	SE, MA, MS, SP, FL	To 5.5 m/ 18 ft	Evergreen, forms dense thickets, has ornamental dwarf form, full sun	Prefers sandy soils, grows on coast, tolerates salt spray
Yellow paloverde <sup>3</sup>	Transplants	Oct-Mar	B&B or potted in nursery	Jan-Apr	SW, CA	To 6.4 m/ 21 ft	Deciduous, legume, shrubby, full sun	Tolerates extreme drought/some salinity, prefers sandy soil
<u>Large Trees</u>								
American beech <sup>1,3</sup>	Transplants	Sep-Mar	B&B or potted in nursery	Mar-Jun	NE, MA, SE, MS, GL, MRV, SP	To 27.4 m/ 90 ft	Deciduous, with shallow root system, full sun	Best in moist conditions, poorly drained soils
(Sheet 31 of 35)								

Table D-1 (Continued)

Species* (Alphabetized by Common Name)	Best Propagule Type	Collection Periods**	Temporary Storage Requirements**	Planting Periods**	Range†	Mature Height	Growth Habits	Remarks
<u>Large Trees (Continued)</u>								
American sycamore <sup>1,3</sup>	Transplants	Sep-Mar	B&B or potted in nursery	Mar-Jun	NE, MA, SE, MS, SP, MP, NP, GL, MRV	To 27.4 m/ 90 ft	Deciduous, wide spreading crown, full sun	Best in moist soils, but grows under a variety of conditions
Australian pine <sup>1,3</sup>	Transplants	Oct-Feb	B&B or potted in nursery	Dec-Apr	FL, GL	To 41.1 m/ 135 ft	Narrowleaf evergreen, drooping branches, full sun	Grows well in sandy soils, exotic naturalized in U.S.
Black cherry <sup>1,3</sup>	Transplants	Aug-Oct	B&B or potted in nursery	Mar-Jun	NE, MA, SE, FL, MS, SP, MP, NP, GL	To 6.8 m/ 55 ft	Deciduous, upright crown, full sun	Can be grown from seed, wood highly prized for furniture
Black cottonwood <sup>1,3</sup>	Transplants, cuttings	Sep-Mar	B&B or potted in nursery (trans.) layered in rooting medium (cuttings)	Mar-Jun	PNW, SW, CA	To 35 m/ 115 ft	Deciduous, fast growing, large, full sun	Used for paper products, prefers moist soils, used for windbreaks/shade
Black gum <sup>1,3</sup>	Transplants	Sep-Mar	B&B or potted in nursery	Mar-Jun	NE, MA, SE, FL, MS, SP, MP, NP, MRV, GL	To 24.4 m/ 80 ft	Deciduous, upright crown, slow growing, full sun	Prefers moist soil
Black locust <sup>1,3</sup>	Transplants	Sep-Mar	B&B or potted in nursery	Mar-Jun	MS, MA, MP	To 22.9 m/ 75 ft	Deciduous, fragrant flowers, spiny, full sun	Tolerates drought/poor soil conditions, a legume
Black walnut <sup>1,3</sup>	Seeds, seedlings	Sep-Nov (seeds); Sep-Mar (seedlings)	Stratified (seeds), B&B or potted (trans.)	Mar-Jun	MA, SE, MS, SP, NP, MRV	To 27.4 m/ 90 ft	Deciduous, edible, upright crown, sun to shade	Varied soil conditions, good plant food, excellent furniture wood, grows slowly
Black willow <sup>1</sup>	Transplants, cuttings	Oct-Mar	B&B or potted in nursery (trans.) layered in rooting medium	Feb-Jul	SE, MS, MA, SP, FL	To 11 m/ 36 ft	Deciduous, shrubby, full sun	Very fast growing, prefers moist/flooded soils
Cow oak <sup>3</sup>	Seeds, transplants	Sep-Nov (seeds); Oct-Mar (trans.)	Stratified at 5E C, B&B or potted in nursery	Mar-Jun	MA, SE, FL, MS, SP	To 21.9 m/ 72 ft	Deciduous, large edible seeds, full sun to part shade	Prefers moist soils, fast growing

Table D-1 (Continued)

Species* (Alphabetized by Common Name)	Best Propagule Type	Collection Periods**	Temporary Storage Requirements**	Planting Periods**	Range†	Mature Height	Growth Habits	Remarks
<u>Large Trees (Continued)</u>								
Eastern cottonwood <sup>1,3</sup>	Transplants, cuttings	Sep-Mar	B&B or potted in nursery (trans.) layered in rooting medium (cut.)	Mar-Jun	MA, SE, GL, MRV, NP, MP, SP, MS	To 27.4 m/ 90 ft	Deciduous, very fast growing, full sun	Used for paper products, shade, prefers moist soil
Eastern red cedar <sup>1,3</sup>	Transplants, seeds	Sep-Mar (trans.); Sep-Nov (seeds)	B&B, potted in nursery (trans.), stratified at 5EC (seeds)	Feb-Jun	SE, MS, SP, MRV	To 11 m/ 36 ft	Narrowleaf evergreen, drought tolerant, full sun	Produced commercially by tree nurseries, tolerates alkaline soil, has shrub form under stressed conditions
Eastern white pine <sup>3</sup>	Transplants	Sep-Mar	B&B or potted in nursery	Mar-Jun	NE, GL, MA	To 27.4 m/ 90 ft	Narrowleaf evergreen, pyramidal crown, full sun	Prefers moist sandy soil
Green ash <sup>1</sup>	Transplants	Sep-Mar	B&B or potted in nursery	Mar-Jun	Eastern and mid U.S.	To 21.9 m/ 72 ft	Deciduous, full or partial shade	Prefers moist soils, tolerates poor soil conditions
Hackberry <sup>1,3</sup>	Transplants	Sep-Mar	B&B or potted in nursery	Feb-Jun	SE, MS, SP, MRV, MP	To 27.4 m/ 90 ft	Deciduous, large spreading crown, full sun	Tolerates alkaline/sandy soils
Honeylocust <sup>1,3</sup>	Transplants	Sep-Mar	B&B or potted in nursery	Mar-Jun	SE, MA, GL, MRV, SP, MP, MS	To 21.9 m/ 72 ft	Deciduous legume, spiny, full or partial sun	Prefers moist fertile soils
Laurel oak <sup>1,3</sup>	Transplants	Sep-Mar	B&B or potted in nursery	Jan-Mar	SE, SP, MS	To 27.4 m/ 90 ft	Flat topped crown, broadleaf evergreen, full sun	Prefers moist soils, occurs on coasts
Live oak <sup>1,3</sup>	Transplants	Sep-Mar	B&B or potted in nursery	Jan-May	SE, SP, MS, MA	To 13.7 m/ 45 ft	Evergreen, large spreading crown, full sun	Prefers sandy moist soils, occurs on coasts, tolerates salt spray
Loblolly pine <sup>1,3</sup>	Transplants, seedlings	Sep-Mar	B&B or potted in nursery	Feb-Jun	SE, SP, MS, MA	To 19.8 m/ 65 ft	Narrowleaf evergreen, large crown, full sun	Coastal/interior plant, on sandy/silty soils (poorly drained)
Longleaf pine <sup>1,3</sup>	Transplants, seedlings	Sep-Mar	B&B or potted in nursery	Feb-May	MA, SE, MS, FL, SP	To 33.5 m/ 110 ft	Narrowleaf evergreen, tall open crown, full sun	Prefers sandy conditions, but occurs in other soils, occurs on coasts
Mockernut hickory <sup>3</sup>	Transplants, seedlings	Sep-Mar	B&B or potted in nursery	Feb-May	NE, MA, SE, FL, MS, MRV, SP, MP	To 22.9 m/ 75 ft	Deciduous, arching branches, full or partial sun	Prefers drier soils, edible nuts, hardy, common

(Sheet 33 of 35)

Table D-1 (Continued)

Species* (Alphabetized by Common Name)	Best Propagule Type	Collection Periods**	Temporary Storage Requirements**	Planting Periods**	Range†	Mature Height	Growth Habits	Remarks
<u>Large Trees (Continued)</u>								
Paper mulberry	Transplants	Sep-Mar	B&B or potted in nursery	Mar-Jun	Eastern U.S.	To 13.7 m/ 45 ft	Deciduous, arching branches, full or partial sun	Exotic, naturalized in U.S., fast growing, forms thickets
Peachleaf willow <sup>1</sup>	Transplants, cuttings	Sep-Mar	B&B or potted in nursery (trans.), layered in rooting medium (cuttings)	Mar-Jun	GL, NP, MP, MW	To 16.8 m/ 55 ft	Deciduous, drooping branches, full sun	Prefers moist soils, grows on dredged material islands
Pecan <sup>3</sup>	Transplants, seedlings	Sep-Mar	B&B or potted in nursery	Feb-May	SE, MS, SP, MP	To 39.6 m/ 130 ft	Deciduous, irregular crown, full sun	Prefers moist soils, but grows in wide range of soil conditions, edible nuts
Persimmon <sup>1</sup>	Rootstock	Sep-Mar	In soil beds in nursery	Feb-Jun	MA, SE, FL, MS, SP, MP, MRV	To 16.8 m/ 55 ft	Deciduous, drooping branches, full sun	Prefers moist, rich soils, but tolerates wide range of soil conditions, edible fruit
Pignut hickory	Transplants, seedlings	Sep-Mar	B&B or potted in nursery	Feb-May	NE, MA, SE, FL, MS, MRV, SP, MP	To 21.3 m/ 70 ft	Deciduous, open crown, full sun	Prefers drier soils than other hickories
Redbay <sup>1</sup>	Transplants	Oct-Mar	B&B or potted in nursery	Feb-May	MA, FL, SE, MS, SP	To 16.8 m/ 55 ft	Evergreen, upright branches, full or partial sun	Often occurs in dense woods, prefers moist soils
Red maple <sup>1,3</sup>	Transplants	Sep-Mar	B&B or potted in nursery	Feb-Jun	Entire eastern U.S.	To 22.9 m/ 75 ft	Deciduous, upright branches, full or partial sun	Prefers moist soils, widely used as an ornamental
Red mulberry <sup>1,3</sup>	Transplants	Sep-Mar	B&B or potted in nursery	Mar-Jun	Entire eastern U.S.	To 20.1 m/ 66 ft	Deciduous, rounded dense crown, full or partial shade	Prefers moist, fertile soils, edible fruit
River birch <sup>1,3</sup>	Transplants	Sep-Mar	B&B or potted in nursery	Feb-Jun	MA, SE, MS, SP, MP, MRV	To 22.9 m/ 75 ft	Deciduous, irregular multi-stemmed, full or partial sun	Prefers moist soils, used as ornamental, common in South
Sassafras <sup>1,3</sup>	Transplants	Oct-Mar	B&B or potted in nursery	Feb-May	NE, MA, SE, MS, SP, MP, NP, GL, MRV	To 24.4 m/ 80 ft	Deciduous, spreading branches, full or partial sun	Prefers upland soils but occurs over wide range of soil conditions, forms dense thicket
Slash pine <sup>1,3</sup>	Transplants, seedlings	Oct-Mar	B&B or potted in nursery	Feb-May	SE, FL, MS	To 27.4 m/ 90 ft	Narrowleaf evergreen, dense, rounded crown, full sun	Grows rapidly, commercial forest tree, occurs on coast

(Sheet 34 of 35)

Table D-1 (Concluded)								
Species* (Alphabetized by Common Name)	Best Propagule Type	Collection Periods**	Temporary Storage Requirements**	Planting Periods**	Range†	Mature Height	Growth Habits	Remarks
<u>Large Trees (Continued)</u>								
Southern red oak <sup>3</sup>	Transplants, seedlings	Oct-Mar	B&B or potted in nursery	Feb-May	MA, SE, MS, SP	To 22.9 m/75 ft	Deciduous, rounded crown, full sun	Prefers poor upland soil, used as an ornamental
Sugarberry <sup>1,3</sup>	Transplants	Oct-Mar	B&B or potted in nursery	Mar-Jun	SE, FL, MS, SP, MP	To 11 m/36 ft	Deciduous, spiny, irregular crown, full sun	Prefers alkaline, well-drained soils
Sugar maple <sup>1,3</sup>	Transplants	Sep-Mar	B&B or potted in nursery	Mar-Jun	GL, NE, MRV, NP, MP, MA	To 27.4 m/90 ft	Deciduous, rounded crown, full sun	Prefers moist soils, used for wood/for furniture/as an ornamental/for syrup
Sweetbay <sup>1</sup>	Transplants	Oct-Mar	B&B or potted in nursery	Feb-May	MA, SE, FL, MS	To 16.8 m/55 ft	Evergreen, shrub in north, tree in south, full sun to partial shade	Prefers moist, soils, deciduous in north
Sweetgum <sup>1</sup>	Transplants, seedlings	Sep-Mar	B&B or potted in nursery	Feb-Jun	MA, SE, FL, MS, SP, MRV	To 33.5 m/110 ft	Deciduous, spreading crown, fast growing, full sun	Prefers well-drained soil, tolerates many soil conditions, used for furniture
Tulip poplar <sup>1,3</sup>	Transplants	Sep-Mar	B&B or potted in nursery	Feb-Jun	NE, MA, SE, MS, MRV, GL	To 42.7 m/140 ft	Deciduous, fast growing, full sun	Prefers moist soil
Water oak <sup>1,3</sup>	Transplants, seedlings	Oct-Mar	B&B or potted in nursery	Feb-May	SE, MA, FL, MS, SP	To 19.8 m/65 ft	Deciduous, rounded crown, full sun	Prefers moist soil, fast growing, produces abundant, small, bitter acorns
White ash <sup>1,3</sup>	Transplants	Sep-Mar	B&B or potted in nursery	Mar-Jun	Eastern and mid-U.S.	To 21.9 m/72 ft	Deciduous, upright crown, full sun	Prefers upland well-drained areas, fast growing
White oak <sup>3</sup>	Transplants, seedlings	Sep-Mar	B&B or potted in nursery	Feb-June	NE, MA, SE, MS, GL, MRV, SP, MP, NP	To 27.4 m/90 ft	Deciduous, spreading rounded crown, full sun	Tolerates wide range of soil/ climatic conditions, edible acorns
White poplar <sup>3</sup>	Transplants, cuttings	Sep-Mar	B&B or potted in nursery	Feb-June	Entire U.S.	To 21.9 m/72 ft	Deciduous, multi-trunked, full sun	Fast growing, exotic naturalized over much of U.S.
(Sheet 35 of 35)								

D.2 Recommended Propagules. Table D-2 lists recommended propagules and techniques for selected marsh species.

**Table D-2. Recommended Propagules and Techniques for Selected Marsh Species (Landin 1978)**

Species	Recommended Propagules	General Collection, Handling, and Planting Techniques	Remarks
Alkali bulrush	Transplants, tubers	Dig plants/tubers; divide; replant onsite at the same depth or pot for holding in a nursery or greenhouse.	Seeds frequently eaten by waterfowl and other birds; used for soil stabilization; prefers fine-textured soils. Fresh/brackish water.
Arrow arum <sup>2</sup>	Transplants, seeds	Dig plants; separate; replant at the same depth onsite or pot for holding. Gather seeds when mature; store in fresh water at 33-37°; broadcast onsite; rake into the soil.	Primarily a good soil stabilizer although seeds are infrequently eaten by waterfowl, and muskrats use the plants for lodge material. Potential pest plant. Fresh water.
Beak rush <sup>2</sup>	Seeds	Gather seeds when mature (July-September); store in fresh water at 41°; broadcast onsite; rake into the soil.	Seeds eaten primarily by waterfowl. Fresh water.
Beggar's ticks <sup>2</sup>	Seeds	Gather seeds when mature (July-September); store dry at 41°; broadcast onsite; rake into the soil.	Good food source for songbirds, game birds, and chicks. Potential pest plant. Fresh water.
Big cordgrass <sup>2</sup>	Transplants, seedlings	Dig young plants from natural stands; separate; replant onsite at the same depth or pot for holding. Germinate seeds and grow seedlings until ready for planting (3-6 months).	Excellent soil stabilizer in low, brackish marshes. Salinity prevents this species from competing with smooth cordgrass. Seeds eaten by many birds; rodents eat young, tender foliage. Potential pest plant. Fresh/brackish water.
Bigelow's glasswort <sup>2</sup>	Cuttings, rootstock	Collect 5-15 cm (2-6 in.) cuttings from the top shoots and broadcast in a wet area onsite. If cuttings must be stored, they must remain moist. Dig rootstock; replant onsite at the same depth.	Low tidal area soil stabilizer away from shorelines. Tolerates fairly high salinities. Easily propagated. Poor source of wildlife foods. Occasionally used by nesting colonial seabirds. Brackish/saline water.
Black mangrove <sup>2</sup>	Seed, seedlings	Collect seed pods when mature (summer and fall); plant whole pods upright in the soil with the stem end up and out of the soil. Dig seedlings from a natural stand or grow them from seed pods.	Excellent soil stabilizer in south Florida. Frequently occurs on dredged material islands and is used by colonial nesting wading bird species. Tolerates up to 40 ppt salinity. Saline.
Black needlerush <sup>2</sup>	Transplants	Dig clumps; divide into sections with a cutting device; replant onsite at the same depth or pot for holding.	Good high marsh soil stabilizer. Will not tolerate extended inundation and naturally occurs on tidal creek banks and high spots in the marsh. Seeds eaten by birds and small animals. Fresh/brackish water.
Bladderworts	Cuttings	Collect quantities of cuttings in buckets of water by scooping plants out of natural stands (in water); transfer to standing water on site.	Good waterfowl food source, especially for dabbling ducks. Potential pest plant in reservoirs. Fresh water.

(Sheet 1 of 9)

Sources of information used in the preparation of this table came from unpublished data by the author (Landin) and the following references: Adams (1963), Barbour and Davis (1970), Britton and Brown (1970), Brockman (1968), Broome et al. (1973), Burkhalter et al. (1974), Chabreck (1970), Correll and Johnston (1970), Duncan (1974), Eyles and Robertson (1963), Fassett (1960), Harris and Marshall (1960), Hitchcock (1950), Hotchkiss (1967), Hotchkiss (1970), Kadlec and Wentz (1974), Long and Lakela (1971), Martin et al. (1951), Mason (1969), Palmisano (1972), Radford et al. (1968), Salyer (1949), Seneca (1972), and Woodhouse et al. (1972).

<sup>1</sup> Transplants include plugs, sprigs, groups of individuals, very large seedlings, and large whole plants.

<sup>2</sup> Known to occur on dredged material.

<sup>3</sup> Commercially available.



Table D-2 (Continued)			
Species	Recommended Propagules	General Collection, Handling, and Planting Techniques	Remarks
Broadleaf arrowhead <sup>2</sup>	Transplants	Dig clumps; separate individuals; replant onsite or pot for holding.	Good waterfowl food source; good cover for wildlife; muskrat food. Fresh water.
Bulrushes <sup>2</sup>	Transplants, tubers	Dig plants; divide; replant onsite or pot for holding. Dig tubers; separate; cut off the top shoots to 15 cm (6 in.), if present; replant onsite or pot for holding.	Excellent waterfowl and songbird food (seeds); foliage eaten by muskrats; used for cover, breeding, and nesting by many species. Fresh/brackish water.
Burreed <sup>2</sup>	Transplants	Dig plants; divide; replant onsite or pot for holding.	Seeds infrequent source of wildlife food. Fresh/brackish water.
Buttercups	Cuttings	Collect quantities of cuttings in buckets of water by scooping plants out of natural stand (in water); transfer to standing water on site.	Good waterfowl food source. Potential pest plant in reservoirs. Fresh water.
Buttonbush <sup>2</sup>	Transplants, seeds	Dig small plants (large seedlings); transplant onsite or pot for holding. Collect seeds in August-September; store seeds in fresh water at 41°.	Seeds good source of food for waterfowl and other birds, insects, beavers, and muskrats. Provides cover and nesting habitat for birds. Fresh water.
Chufa <sup>2,3</sup>	Tubers	Dig tubers when mature (July-Sept.); separate from other plant material; store moist but not wet at 41°; broadcast onsite and rake into the soil. Tubers are very small and may be treated as seeds.	Excellent food source for waterfowl, turkeys, deer, wild boar, songbirds; highly productive plants may produce hundreds of tubers per plant. Seeds, tubers, foliage all relished. Fresh water.
Common reed <sup>2</sup>	Transplants, rootstock	Dig plants; divide; replant onsite or pot for holding. Dig rootstock; separate into sections with at least one growth point; plant onsite.	Used for nesting by songbirds, marsh birds, and water birds. Stabilizes soil; rapid growth with tall, rank form. Definite pest plant on placement sites. Fresh/brackish water.
Common threesquare <sup>2</sup>	Transplants, tubers	Dig plants, divide, replant onsite at the same depth or pot for holding. Dig tubers; divide; cut off the top shoots, if present; replant onsite.	Good source of food for waterfowl, muskrats, and nutria. Used for soil stabilization. Fresh/brackish water.
Delta duckpotato <sup>2,3</sup>	Transplants	Dig plants, separate individuals; replant onsite at the same depth or pot for holding.	Excellent waterfowl food source; good soil stabilizer; only grows well on fine-textured soils. Fresh water.
Dock <sup>2</sup>	Seeds	Collect seeds when mature (May-July); store dry at room temperature or less; plant broadcast onsite and rake into the soil.	Good food source for songbirds (seeds). Hardy species that is good soil stabilizer. Fresh water.
Dotted smartweed <sup>2</sup>	Seeds, cuttings	Collect seeds; store dry at room temperature or less; broadcast onsite; rake into the soil. Take cuttings from natural stand; broadcast on wet area on site (not standing water).	Good soil stabilizer; good cover for ducklings; seeds eaten by waterfowl, muskrats, and deer. Foliage not palatable to herbivores. Fresh water.
Duckpotato <sup>2</sup>	Transplants	Dig plants; separate individuals; replant onsite or pot for holding.	Excellent food source for waterfowl. Fresh water.
Duckweeds <sup>2</sup>	Whole plants	Collect buckets of plants from a natural stand in water; place the whole plant in standing permanent water onsite.	Excellent food source for waterfowl, especially wood ducks. Good cover. In deep south can be a pest plant in standing water in reservoirs. Fresh water.

(Sheet 2 of 9)

Table D-2 (Continued)

Species	Recommended Propagules	General Collection, Handling, and Planting Techniques	Remarks
Eelgrass <sup>2</sup>	Transplants	Dig clumps with coring devices; replant in shallow seawater with a minimum of current and wave action.	Good soil stabilizer in bay bottoms; food source for diving ducks; provides cover for marine organisms. Saline.
European glasswort <sup>2</sup>	Cuttings, rootstock	Take 5-15 cm (2-6 in.) cuttings from the top shoots; broadcast on a wet area onsite. Dig rootstock; divide into clumps; replant onsite at the same depth.	Used primarily for soil stabilization, but not for shorelines. Poor wildlife food use; occasionally used by nesting colonial seabirds. Brackish/saline water.
Fimbristylis <sup>2</sup>	Transplants, seeds	Dig plants; separate individuals; replant onsite at the same depth or pot for holding. Collect seeds when mature (July-September); store dry; broadcast onsite; rake into the soil.	Fair food source for songbirds and occasionally for waterfowl. Fresh/brackish water.
Foxtail grasses	Sprigs, seeds	Dig young plants; replant as sprigs on site at the same depth or pot for holding as transplants. Collect seeds when mature (June-October, depending upon species); store dry at 41°; broadcast onsite.	Good source of food for most birds, browsers and grazers, and rodents. Cover for many wildlife species. Fresh water.
Frankenia	Transplants	Dig plants; separate individuals; replant onsite at the same depth or pot for holding.	Soil stabilizer; poor source of food but some use as cover by wildlife. Fresh/brackish water.
Frog bit <sup>2</sup>	Seeds	Collect seeds when mature (July-September); store dry at room temperature or less; broadcast onsite; rake into the soil.	Good seed source for songbirds; cover for small animals and birds; some use for stabilization. Fresh water.
Giant reed <sup>2</sup>	Seeds, transplants	Collect seeds when mature; store dry at room temperature or less; broadcast onsite; rake into the soil. Dig plants; divide; replant onsite or pot for holding.	Hardy plant; good seed source for wildlife; used for soil stabilization. Fresh water.
Groundsel tree <sup>2</sup>	Seedlings	Dig seedlings in natural stands; at least 30-45 cm (12-18 in.) is the minimum height for best survival; replant onsite at the same depth or pot for holding.	Excellent cover for nesting/breeding species; used frequently by colonial nesting wading birds on dredged material islands. Poor food source. Fresh/brackish water.
Hardstem bulrush <sup>2</sup>	Transplants, tubers	Dig plants; divide; replant onsite or pot for holding. Dig tubers; divide from the other plant material; cut off the top shoots to 15 cm (6 in.), if present; plant onsite at the same depth.	Excellent seed source for birds; hardy species; used by muskrats and for soil stabilization. Fresh water.
Horned pondweed	Cuttings, rootstock	Gather plant material from standing water; place onsite in permanent standing water areas. Dig rootstock from shallow water areas where possible; plant intact on site.	Fair food source for waterfowl, especially dabbling ducks; good sediment stabilizer. Fresh water.
Horsetails <sup>2</sup>	Transplants	Dig plants; separate individuals; replant onsite or pot for holding.	Poor food source; only use is soil stabilization. Fresh water.
Japanese millet <sup>2,3</sup>	Seeds	Buy seeds from a commercial seed source.	Excellent upland and marsh bird food; relished by waterfowl; eaten by turkeys, raccoons and other small animals, and deer. Used in game management as a food plot source. Fresh water.
Ladysthumb <sup>2</sup>	Cuttings, seeds	Take 5-15 cm (2-6 in.) cuttings from the top shoots; broadcast on wet areas onsite; rake into the soil. Collect seeds when mature; store in fresh water; broadcast onsite; rake into the soil.	Excellent source of food for waterfowl and for upland game and songbirds. Fresh water.

Table D-2 (Continued)			
Species	Recommended Propagules	General Collection, Handling, and Planting Techniques	Remarks
Lizard's tail <sup>2</sup>	Transplants, seeds	Dig plants; separate individuals; replant onsite or pot for holding. Collect seeds when mature (June-August); store in fresh water; broadcast onsite; rake into the soil.	Fair food source; used for soil stabilization in intermittent ponded areas. Fresh water.
Lobelia	Transplants	Dig plants; separate individuals; replant onsite or pot for holding.	Fair food source; possibly used for soil stabilization. Fresh water.
Lotus	Seeds, rootstock	Collect seeds when mature (August-October); remove from pods; store in fresh water at 41°; broadcast in shallow water onsite. Dig rootstock when water is very low (late summer, fall); plant in shallow water onsite.	Fair food source for waterfowl; relished by wild boars (roots); excellent cover for ducklings; potential pest plant in standing water and shallow reservoirs. Fresh water.
Lyngbye's sedge <sup>2</sup>	Transplants, seeds	Dig plants, separate individuals; replant onsite or pot for holding. Collect seeds when mature (July-September); store dry at room temperature; broadcast onsite.	Good food source for waterfowl and other birds; good cover for many species. Fresh water.
Manna grass <sup>2</sup> ( <i>G. acutiflora</i> )	Seeds, sprigs	Collect seeds when mature; store dry at room temperature or less; broadcast onsite. Dig young plants for sprigs; replant onsite or pot for holding as transplants.	Excellent seed source for many bird species; foliage eaten by small and large animals; good cover. Fresh water.
Manna grass <sup>2</sup> ( <i>G. fluitans</i> )	Seeds, sprigs	Same procedures as for Manna grass ( <i>G. acutiflora</i> ).	Excellent seed source for many bird species and other wildlife. Good cover. Grows in wetter areas than Manna grass ( <i>G. acutiflora</i> ). Fresh water.
Marsh elder <sup>2</sup>	Seedlings	Dig seedlings in natural stands near parent plants; separate individuals; replant onsite or pot for holding. Seedlings should be at least 30 cm (12 in.) tall.	Excellent cover species for birds and small animals; used by colonial nesting wading birds for nesting substrate. Potential pest plant. Fresh/brackish water.
Marsh hibiscus <sup>2</sup>	Seeds, transplants	Collect seeds when mature (August-October); store dry at 41°; plant onsite at least 5-7.5 cm (2-3 in.) deep. Dig plants; replant onsite or pot for holding.	Good cover for birds and sunning turtles; grows on the banks of streams and ponds, and in ditches; good soil stabilizer. Fresh water.
Marsh pepper <sup>2</sup>	Cuttings, rootstock	Take 5-15 cm (2-6 in.) cuttings from the top shoots; broadcast on wet areas onsite; rake into the soil. Dig rootstock; divide into sections; plant in wet areas onsite.	Excellent seed source for waterfowl and other birds; foliage bitter to browsers; good cover and soil stabilizer. Fresh water.
Marsh smartweed <sup>2</sup>	Cuttings, seeds	Cuttings: Same procedure as for Marsh pepper. Collect seeds when mature (June-September); store or plant immediately onsite; rake in soil.	Excellent seed source for waterfowl and other birds; good cover for many wildlife species. Not palatable to herbivores. Fresh water.
Mud plantain <sup>2</sup>	Cuttings	Take 5-15 cm (2-6 in.) sections from the top shoots; replant in mud and wet areas onsite, taking care to bury portions of cutting in soil.	Good soil stabilizer in intermittent ponds and streams. Fresh water.
Nodding smartweed <sup>2</sup>	Seeds	Collect seeds when mature (June-September); store in fresh water at 41°; broadcast onsite; rake into the soil.	Abundant seed source for upland and waterfowl birds; grows in drier soils than do most smartweeds. Potential pest plant. Not palatable to herbivores. Fresh water.

(Sheet 4 of 9)

Table D-2 (Continued)

Species	Recommended Propagules	General Collection, Handling, and Planting Techniques	Remarks
Nutsedges <sup>2</sup>	Tubers, rootstock	Dig tubers in late summer and fall; divide; plant onsite or pot for using as transplants. Dig rootstock; divide into sections; plant onsite, same depth.	Excellent food source for most wildlife, especially chufa and red-rooted sedge. Some species are commercially available; potential pest plant in agronomic areas. Fresh water.
Olney's threesquare <sup>2</sup>	Transplants, tubers	Dig plants, separate individuals; plant onsite or pot for holding. Dig tubers; separate; plant onsite at the same depth.	Excellent food source for waterfowl, muskrats, nutria, and other small animals. Good soil stabilizer. Fresh water.
Orache <sup>2</sup>	Seeds	Collect seeds when mature; store dry at room temperature or less. Broadcast onsite and rake into the soil.	Good source of seeds for birds and rodents; good soil stabilizer. Fresh/brackish water.
Pacific cordgrass <sup>2</sup>	Transplants, sprigs	Dig young plants from edge of marsh; plant at the same depth immediately as sprigs, or grow in pots and transplant into site as larger plants. Growing from seeds not recommended as seeds have very low viability rate.	Only low marsh soil stabilizer on west coast that tolerates both high salinities and strong tidal action. Good soil stabilizer; good cover; very slow growth. Saline.
Red mangrove <sup>2</sup>	Seeds, seedlings	Collect seed pods when mature; plant whole pod upright in soil with stem end up and out of the soil. Dig seedlings from natural stand or grow from seed pods.	Excellent soil stabilizer in south Florida. Frequently occurs on dredged material islands and used by colonial nesting wading birds for nesting. Saline.
Reed canary grass <sup>2,3</sup>	Seeds	Buy seeds from a commercial seed source.	Excellent soil stabilizer; seeds good wildlife food source; used to dewater and filter wastewater. Fresh water.
Reed grass <sup>2</sup>	Seeds, sprigs	Collect seeds when mature (July-September); store dry at 41°; broadcast onsite. Dig young plants to use for sprigs; separate individuals; plant onsite or pot for growing as transplants.	Excellent seed source for birds; grazed heavily by mammals and rodents. Good soil stabilizer. Fresh water.
Reed manna grass <sup>2</sup>	Seeds, sprigs	Same procedures as for Reed grass.	Same as for Reed grass. Fresh water.
Rice cutgrass <sup>2</sup>	Seeds, sprigs	Collect seeds when mature (May-July); store in fresh water at 41°; broadcast onsite; rake into the soil (in wet areas). Dig young plants; separate individuals; plant in wet areas onsite at the same depth.	Good seed and foliage food source for many wildlife species, especially waterfowl and marsh birds. Good soil stabilizer of banks. Fresh water.
River bulrush <sup>2</sup>	Transplants, rootstock	Dig rootstock, divide into sections; plant at the same depth on site. Dig plants; separate individuals; transplant onsite or pot for holding.	Used frequently by nesting waterfowl and marsh birds; seeds good food source for many wildlife species. Good soil stabilizer. Fresh water.
Rushes <sup>2</sup>	Transplants, rootstock, seeds	Dig plants; separate individuals; transplant to site or pot for holding. Dig rootstock; divide into sections; plant at the same depth on site. Collect seeds when mature (July-Oct); store in fresh water at 41°; broadcast onsite; rake into the soil.	This group of plant species excellent for waterfowl, small animal, other birds' food; used as nesting substrate by waterfowl and marsh birds; good soil stabilizers; hardy plants. Fresh water.
Saltgrass <sup>2</sup>	Sprigs, rhizomes	Dig young plants, divide into sections; plant onsite or pot for holding. Dig roots; divide rhizomes into small sections; plant onsite; rake into the soil.	Excellent soil stabilizer; grows well in high brackish marshes; used as lodge material by muskrats; seeds fair food source, but foliage poor source. Brackish/saline water.

Table D-2 (Continued)			
Species	Recommended Propagules	General Collection, Handling, and Planting Techniques	Remarks
Saltmarsh aster <sup>2</sup>	Seeds	Collect seeds when mature (July-September); store dry at room temperature or less; broadcast onsite; rake into the soil.	Good soil stabilizer in high coastal marshes. Fresh/brackish water.
Saltmarsh bulrush <sup>2</sup>	Transplants, tubers	Dig plants; divide; plant onsite at the same depth or pot for holding. Dig tubers; separate tubers; cut off the top shoots, if present; plant onsite at the same depth.	Excellent food source for waterfowl and muskrats, nutria, other small animals. Good cover; good soil stabilizer; used by muskrats for lodge material. Brackish water.
Saltmarsh cattail <sup>2</sup>	Transplants, rootstock	Dig plants; separate individuals; plant onsite at the same depth. Dig roots; separate; cut off the top shoots, if present; plant onsite.	Good soil stabilizer. Occurs in ditches, intermittent ponds, primarily on coasts. Low food value; fair cover. Fresh/brackish water.
Saltmarsh jaumea <sup>2</sup>	Transplants	Dig plants, separate individuals; plant onsite at the same depth or pot for holding.	Fair soil stabilizer on west coast in high brackish marshes. Brackish/saline water.
Saltmeadow cordgrass <sup>2</sup>	Transplants, sprigs	Dig plants; divide into clumps; plant onsite at the same depth or pot for holding. Dig young plants; separate; plant onsite at the same depth.	Excellent soil stabilizer in brackish marshes; also used in dune stabilization on Atlantic coast. Seed production often poor; low food value; some cover value. Brackish water.
Saw grass <sup>2</sup>	Sprigs, seeds	Dig young plants; separate individuals; plant onsite or pot for holding. Collect seeds when mature (July-September); store in fresh water at 41°; broadcast onsite; rake into the soil.	Species very site specific; occurs only in Florida and in isolated spots along the Gulf Coast. Will not tolerate high nutrient levels. Good soil stabilizer; good cover; seeds eaten by some wildlife. Fresh water.
Sea lavender <sup>2</sup> <i>L. carolinianum</i> )	Seeds	Collect seeds when mature (July-August); store dry at 41°; broadcast onsite; rake into the soil.	Fair soil stabilizer; cover. Low food value. Some nesting substrate value. Fresh/brackish water.
Sea lavender <sup>2</sup> <i>(L. vulgare)</i>	Seeds	Same procedures as for Sea lavender ( <i>L. carolinianum</i> ).	Same values as for Sea lavender ( <i>L. carolinianum</i> ). Fresh/brackish water.
Sea ox-eye <sup>2</sup>	Transplants, seeds	Dig plants; separate individuals; plant onsite at the same depth or pot for holding. Collect seed heads when mature (July-October); store seeds in fresh water at 41°; plant onsite; rake into the soil.	Excellent soil stabilizer; grows in high marshes and on shores. Low food value; some cover and nesting value. Brackish water.
Sea purslane <sup>2</sup>	Seeds	Collect seeds when mature; store dry at room temperature or less; plant onsite; rake into the soil.	Fair soil stabilizer value; low food value; some seed value as food. Some cover use. Fresh/brackish water.
Seaside arrowgrass <sup>2</sup>	Transplants	Dig plants; divide into individuals or clumps; plant onsite at the same depth or pot for holding.	Excellent soil stabilizer in brackish tidal marshes in Pacific northwest; some cover value; low food value. Fresh/brackish water.
Sedges <sup>2</sup>	Transplants, seeds	Dig plants; separate into clumps or individuals; plant onsite or pot for holding. Collect seeds when mature (June-September); store dry at 41°; broadcast onsite; rake into the soil.	This group of species far-ranging and widely varied. Usually excellent seed value for wildlife; also good cover. Prolific plants. Fresh water.
Shoal grass <sup>2</sup>	Transplants	Dig plugs with coring device in water at low tide; plant at site immediately at the same depth.	Propagules must be stabilized to prevent tidal scour. Good cover value for marine organisms; good sediment stabilizer. Saline water.

(Sheet 6 of 9)

Table D-2 (Continued)			
Species	Recommended Propagules	General Collection, Handling, and Planting Techniques	Remarks
Slough grass <sup>2</sup>	Transplants, seeds	Dig plants; divide into clumps or individuals; plant at the same depth onsite or pot for holding. Collect seeds when mature (July-September); store in fresh water at 41°; broadcast in wet areas onsite.	Good food value for waterfowl and other seed-eating birds; foliage eaten by small animals. Good soil stabilizer. Fresh water.
Slough sedge <sup>2</sup>	Transplants, seeds	Dig plants, separate into clumps; plant onsite at the same depth or pot for holding. Collect seeds when mature (July-October); store in fresh water at 41°; broadcast in wet areas on site; rake into the soil if necessary.	Excellent wildlife seed source; foliage also eaten. Good soil stabilizer. Fresh water.
Smartweeds <sup>2</sup>	Cuttings, seeds	Take 5-15 cm (2-6 in.) cuttings from the top shoots; broadcast onsite; rake into the soil, taking care to cover parts of the cuttings (the site should be wet). Collect seeds, store in fresh water or dry, depending on species; broadcast onsite; rake into the soil.	Excellent group of plants for wildlife value; seeds readily consumed by waterfowl and many other birds and small animals. Good soil stabilizers. Not palatable to herbivores.
Smooth cordgrass <sup>2,3</sup>	Sprigs, transplants	Dig young plants; separate individuals; plant as sprigs on site or pot to hold as transplant. Dig transplants from natural marsh or grow from seeds; plant onsite, taking care to cover all roots.	Best soil stabilizer of low salt marshes on east and gulf coasts. Used extensively for stabilization and marsh creation projects. Good cover value; good food value. Tolerant of tidal inundation for long periods. Saline water.
Soft rush <sup>2</sup>	Transplants	Dig clumps; divide into sections with a cutting device; plant onsite at the same depth or pot for holding.	Persistent high marsh species; good cover value. Some seed value, but foliage inedible. Known pest in pastoral areas. Fresh water.
Softstem bulrush <sup>2</sup>	Rhizomes, transplants	Dig roots; divide rhizomes leaving at least one growth point on each; plant onsite 2.5-7.5 cm (1 to 3 in.) deep. Dig plants; divide into sections; plant onsite or pot for holding.	Excellent soil stabilizer of fresh water coastal and interior marshes. Good seed value for wildlife. Used as cover and nesting material by waterfowl and other wildlife. Fresh water.
Southern bulrush	Rhizomes, transplants	Same procedures as for Softstem bulrush.	Same values as for Softstem bulrush except that this species does not occur as extensively and grows much larger and more robust. Fresh water.
Southern cutgrass <sup>2</sup>	Seeds, sprigs	Collect seeds/sprigs when mature (May-July); store in fresh water at 41°; broadcast in wet areas onsite; rake into the soil if necessary.	Excellent seed value for waterfowl and other birds; foliage eaten by small animals and grazers when tender and young. Good soil stabilizer. Fresh water.
Southern smartweed <sup>2</sup>	Cuttings, seeds	Take 5-15 cm (2-6 in.) cuttings from the top shoots; broadcast in wet areas onsite; rake or place cuttings into the soil. Collect seeds when mature (July-October); store in fresh water at 41°; broadcast onsite; rake into the soil.	Excellent food source for waterfowl and marsh birds. Prolific growth habits; forms dense tall stands. Good cover value. Not palatable to herbivores. Fresh water.
Spatterdock <sup>2</sup>	Transplants	Dig plants; separate individuals; plant onsite at the same depth or pot for holding.	Good waterfowl food; good soil stabilizer. Fresh water.
Spikerushes <sup>2</sup>	Transplants	Dig plants, divide into clumps; plant onsite at the same depth or pot for holding.	Excellent soil stabilizer; fair waterfowl food. Fresh water.

(Sheet 7 of 9)

Table D-2 (Continued)			
Species	Recommended Propagules	General Collection, Handling, and Planting Techniques	Remarks
Spirodella <sup>2</sup>	Whole plants	Scoop buckets of plants from standing water; transfer to standing water onsite.	Good waterfowl food, especially wood ducks. Fresh water.
Sprangletop <sup>2</sup>	Seeds, sprigs	Collect seeds when mature (summer, fall); store dry at room temperature or less; broadcast onsite; rake into the soil. Dig young plants; plant onsite as sprigs.	Excellent seed source for wildlife; good soil stabilizer; used for cover. Fresh water.
Sweet flag	Transplants	Dig plants; divide individuals; plant onsite in high marsh at the same depth.	Good soil stabilizer; fair wildlife value; potential pest plant. Fresh water.
Tufted hairgrass <sup>2</sup>	Transplants, sprigs	Dig plants; divide individuals; plant onsite or pot for holding. Dig young plants; plant as sprigs on site.	Excellent low marsh species for the Pacific Northwest; prolific growth; good cover and fair food wildlife value. Good soil stabilizer. Fresh/brackish water.
Turtle grass <sup>2</sup>	Transplants	Dig clumps with a coring device from water at low tide, taking care that there is at least one growth point in each clump (otherwise, it will not reproduce); plant onsite in the water.	Excellent cover and wildlife value; good cover for marine organisms. Species susceptible to environmental changes by humans; rare in some areas. Saline water.
Walter's millet <sup>2,3</sup>	Seeds	Buy from a commercial seed source.	Excellent food value from waterfowl and other wildlife, such as raccoons, turkey, deer, and muskrats. Good temporary soil stabilizer. Fresh water.
Water hemp <sup>2</sup>	Seeds	Collect seeds when mature; store in fresh water at 41°; broadcast in wet area on site; rake into the soil if necessary.	Good seed source for wildlife; fair soil stabilizer. Fresh water.
Water hyssop	Cuttings, sprigs	Take 5-15 cm (2-6 in.) cuttings from the top shoots; plant in mud onsite. Dig young plants; divide; plant in wet areas onsite.	Good soil stabilizer; fair wildlife food. Fresh water.
Water lilies <sup>2,3</sup>	Rootstock	Dig rootstock in late summer and fall when water levels are low; transplant to shallow water onsite.	Good cover for ducklings; some food value. Excellent sediment stabilizer; potential pest. Fresh water.
Watermilfoils	Cuttings	Gather containers of plant segments from standing water onsite.	Excellent dabbling duck food; good cover. Potential pest plant in standing water and reservoirs. Fresh water.
Water nymphs	Cuttings	Same procedures as for Watermilfoils.	Same values as for Watermilfoils. Fresh water.
Water plantain <sup>2</sup>	Transplants	Dig plants; divide individuals; plant onsite at the same depth.	Good food source for wildlife; fair soil stabilizer. Fresh water.
Water shield	Rootstock	Dig roots in shallow water in late summer and fall; transfer to standing shallow water onsite.	Good cover value, good sediment stabilizer. Fresh water.
Water smartweed <sup>2</sup>	Cuttings, seeds	Take 5-15 cm (2-6 in.) cuttings from the top shoots; plant in wet areas onsite, taking care to bury part of each cutting. Collect seeds when mature (July-September); store in fresh water at 41°; broadcast in wet areas on site.	Excellent waterfowl food, good cover. Excellent sediment and soil stabilizer. Fresh water.
Water willow	Transplants	Dig plants; divide individuals; plant onsite at the same depth.	Fair soil stabilizer; low wildlife value. Fresh water.

(Sheet 8 of 9)

Table D-2 (Concluded)			
Species	Recommended Propagules	General Collection, Handling, and Planting Techniques	Remarks
White mangrove <sup>2</sup>	Seeds, seedlings	Collect seeds when mature; plant immediately on site. Dig seedlings from natural stands; plant onsite.	Excellent soil stabilizer; good cover; low food value; used by nesting birds. Saline water.
Widgeongrass <sup>2</sup>	Cuttings	Remove buckets of segments of plants from standing water; transfer to standing water onsite.	Excellent waterfowl food; grown by waterfowl managers for attracting waterfowl. Brackish water.
Wild celery	Whole plants	Remove whole plants from standing water; transfer to standing water onsite.	Excellent cover value; harbors many invertebrates fed on by wildlife. Shades out aquatic plants; pest in Florida and the Deep South in isolated locations. Fresh water.
Wild rice <sup>2</sup>	Sprigs, seeds	Dig young plants, divide individuals; plant in shallow water on site. Collect seeds when mature; plant in wet areas onsite.	Low tolerance for pollution; must have fine-textured soils in slow-moving water. Excellent wildlife food, good soil stabilizer. Fresh water.
Willows <sup>2</sup>	Cuttings	Take 10-30 cm (4-12 in.) cuttings from dormant trees (winter months, early spring); plant cuttings onsite with the butt end two-thirds into the soil.	Excellent soil stabilizer of stream and pond banks. Good cover and food value for songbirds. Very fast growing, potential pest plant. Fresh water.
Wolffias	Whole plants	Remove buckets of plants from standing water; transfer to standing water onsite.	Excellent waterfowl food; good cover value. Fresh water.
Yellow flag	Transplants, rhizomes	Dig plants; divide individuals; plant in high marsh on site. Dig rhizomes; divide, keeping one growth point on each rhizome; plant shallowly onsite.	Good soil stabilizer, low wildlife value; showy flowers. Fresh water.
(Sheet 9 of 9)			



## APPENDIX E

Common and Scientific Names of Plants  
and Animals Mentioned in this Manual

E.1 Plants. Table E-1 identifies both the common and the scientific names of the plants mentioned in this manual.

Table E-1. Common and Scientific Names of the Plants Mentioned in this Manual

Common Name	Scientific Name
Alders	<i>Alnus</i> spp.
Alfalfa	<i>Medicago sativa</i>
Alkali bulrush	<i>Scirpus</i> sp.
Alsike clover	<i>Trifolium hybridum</i>
American beachgrass	<i>Ammophila breviligulata</i>
American beech	<i>Fagus grandifolia</i>
American bittersweet	<i>Celastrus scandens</i>
American dunegrass	<i>Elymus mollis</i>
American elderberry	<i>Sambucus canadensis</i>
American elm	<i>Ulmus americana</i>
American hornbeam	<i>Carpinus caroliniana</i>
American plum	<i>Prunus americana</i>
American sycamore	<i>Platanus occidentalis</i>
Apples	<i>Malus</i> spp.
Arrow arum	<i>Peltandra virginica</i>
Arrow-leafed tearthumb	<i>Polygonum sagittatum</i>
Arrowwood viburnum	<i>Viburnum dentatum</i>
Australian pine	<i>Casuarina equisetifolia</i>
Autumn olive	<i>Eleagnus umbellata</i>
Bahia grass	<i>Paspalum notatum</i>
Bald cypress	<i>Taxodium distichum</i>
Bamboo vine	<i>Smilax laurifolia</i>
Barley	<i>Hordeum vulgare</i>

(Sheet 1 of 18)

Table E-1 (Continued)

Common Name	Scientific Name
Barnyard grass	<i>Echinochloa crusgalli</i>
Bayberry	<i>Myrica pennsylvanica</i>
Beach morning glory	<i>Ipomoea stolonifera</i>
Beach panic grass	<i>Panicum ararum</i>
Beach pea	<i>Lathyrus japonicus</i>
Beach plum	<i>Prunus maritima</i>
Beach strawberry	<i>Fragaria chiloensis</i>
Beak rush	<i>Rynchospora tracyi</i>
Beaked panic grass	<i>Panicum anceps</i>
Bearberry	<i>Arctostaphylos uva-ursi</i>
Beautyberry	<i>Callicarpa americana</i>
Beet	<i>Beta vulgaris</i>
Beggar's ticks	<i>Bidens</i> spp.
Bermuda grass	<i>Cynodon dactylon</i>
Bicolor lespedeza	<i>Lespedeza bicolor</i>
Big bluestem	<i>Andropogon gerardi</i>
Big cordgrass	<i>Spartina cynosuroides</i>
Big filaree	<i>Erodium botrys</i>
Bigelow's glasswort	<i>Salicornia bigelowii</i>
Bird's foot trefoil	<i>Lotus corniculatus</i>
Bittersweet nightshade	<i>Solanum dulcamera</i>
Black cherry	<i>Prunus serotina</i>
Black cottonwood	<i>Populus trichocarpa</i>
Black gum	<i>Nyssa sylvatica</i>
Black locust	<i>Robinia pseudoacacia</i>
Black mangrove	<i>Avicennia nitida</i>
Black medic	<i>Medicago lupulina</i>
Black needlerush	<i>Juncus romerianus</i>

(Sheet 2 of 18)

Table E-1 (Continued)

Common Name	Scientific Name
Black nightshade	<i>Solanum nigrum</i>
Black raspberry	<i>Rubus occidentalis</i>
Black walnut	<i>Juglans nigra</i>
Black willow	<i>Salix nigra</i>
Blackseed plantain	<i>Plantago rugeli</i>
Bladderworts	<i>Utricularia</i> spp.
Blue brush	<i>Ceanothus thryiflorus</i>
Blue elderberry	<i>Sambucus caerulea</i>
Bottlebrush	<i>Plantago arenaria</i>
Bracted plantain	<i>Plantago aristata</i>
Broadleaf arrowhead	<i>Sagittaria latifolia</i>
Broadleaf cattail	<i>Typha latifolia</i>
Broadleaf plantain	<i>Plantago major</i>
Brazilian peppertree	<i>Schinus terebinthifolius</i>
Brewer saltbush	<i>Atriplex breweri</i>
Bromegrass	<i>Bromus inermis</i>
Broomsedge	<i>Andropogon virginicus</i>
Browntop millet	<i>Panicum ramosum</i>
Buckthorn plantain	<i>Plantago lanceolata</i>
Buffaloberry	<i>Shepherdia canadensis</i>
Bull paspalum	<i>Paspalum boscianum</i>
Bulrushes	<i>Scirpus</i> spp.
Bur reed	<i>Sparganium americanum</i>
Bush lupine	<i>Lupinus albifrons</i>
Bushy beardgrass	<i>Andropogon glomeratus</i>
Buttercups	<i>Ranunculus</i> spp.
Buttonbush	<i>Cephalanthus occidentalis</i>
Buttonwood	<i>Conocarpus erecta</i>

(Sheet 3 of 18)

Table E-1 (Continued)

Common Name	Scientific Name
Cabbage palm	<i>Sabal palmetto</i>
Calandrinia	<i>Calandrinia maritima</i>
California blackberry	<i>Rubus ursinus</i>
California buckthorn	<i>Rhamnus californica</i>
Calley Bermuda grass	<i>Cynodon dactylon</i> var. <i>Calleyi</i>
Camphorweed	<i>Heterotheca subaxillarsis</i>
Canadian serviceberry	<i>Amelanchier canadensis</i>
Carolina ash	<i>Fraxinus caroliniana</i>
Carolina rose	<i>Rosa carolina</i>
Cascara buckthorn	<i>Rhamnus purshiana</i>
Cattails	<i>Typha</i> spp.
Chufa	<i>Cyperus esculentus</i>
Cherry laurel	<i>Prunus caroliniana</i>
Chickasaw plum	<i>Prunus angustifolia</i>
Coastal Bermuda grass	<i>Cynodon dactylon</i> hybrid
Coast deervetch	<i>Lotus formosissimus</i>
Common Bermuda grass	<i>Cynodon dactylon</i>
Common buckthorn	<i>Rhamnus caroliniana</i>
Common chickweed	<i>Stellaria media</i>
Common chokecherry	<i>Prunus virginiana</i>
Common deerberry	<i>Vaccinium stamineum</i>
Common filaree	<i>Erodium cicutarium</i>
Common greenbrier	<i>Smilax rotundifolia</i>
Common juniper	<i>Juniperus communis</i>
Common lambsquarters	<i>Chenopodium album</i>
Common mullein	<i>Verbascum thapsus</i>
Common purslane	<i>Portulaca oleracea</i>

(Sheet 4 of 18)

Table E-1 (Continued)

Common Name	Scientific Name
Common ragweed	<i>Ambrosia artemisiifolia</i>
Common reed	<i>Phragmites australis</i>
Common spikerush	<i>Eleocharis palustris</i>
Common sweetleaf	<i>Symplocos tinctoria</i>
Common three-square	<i>Scirpus americanus</i>
Corn	<i>Zea mays</i>
Cotton	<i>Gossypium hirsutum</i>
Cow oak	<i>Quercus michauxii</i>
Cow pea	<i>Vigna sinensis</i>
Crabapple	<i>Malus angustifolia</i>
Crimson clover	<i>Trifolium incarnatum</i>
Crossvine	<i>Bignonia capreolata</i>
Croton	<i>Croton californicus</i>
Curly dock	<i>Rumex crispus</i>
Dahoon	<i>Ilex cassine</i>
Dallis grass	<i>Paspalum dilatatum</i>
Deertongue	<i>Muhlenbergia rigens</i>
Deerweed	<i>Lotus scoparius</i>
Delta duckpotato	<i>Sagittaria platyphylla</i>
Dock	<i>Rumex</i> spp.
Dotted smartweed	<i>Polygonum punctatum</i>
Downy serviceberry	<i>Amelanchier arborea</i>
Duckpotatoes	<i>Sagittaria</i> spp.
Duckweeds	<i>Lemna</i> spp.
Dwarf spikerush	<i>Eleocharis parvula</i>
Eastern cottonwood	<i>Populus deltoides</i>
Eastern hophornbeam	<i>Ostrya virginiana</i>
Eastern red cedar	<i>Juniperus virginiana</i>

(Sheet 5 of 18)

Table E-1 (Continued)

Common Name	Scientific Name
Eastern white pine	<i>Pinus strobus</i>
Eel grass	<i>Zostera marina</i>
Elderberry	<i>Sambucus glauca</i>
Elderberry	<i>Sambucus callicarpa</i>
Eucalyptus	<i>Eucalyptus</i> spp.
European beach grass	<i>Ammophila arenaria</i>
European glasswort	<i>Salicornia europea</i>
Evergreen blackberry	<i>Rubus laciniatus</i>
Fall panic grass	<i>Panicum dichotomiflorum</i>
Filaree	<i>Erodium obtusifolium</i>
Fimbristylis	<i>Fimbristylis castanea</i>
Firethorn	<i>Pyracantha coccinea</i>
Flat pea	<i>Lathyrus sylvestris</i>
Flowering dogwood	<i>Cornus florida</i>
Flowering spurge	<i>Euphorbia corollata</i>
Fox grape	<i>Vitis labrusca</i>
Foxtail grasses	<i>Setaria</i> spp.
Foxtail millet	<i>Setaria italica</i>
Frankenia	<i>Frankenia grandifolia</i>
Fringed catbrier	<i>Smilax bona-nox</i>
Frog bit	<i>Limnobium spongia</i>
Frost grape	<i>Vitis vulpina</i>
Gallberry	<i>Ilex glabra</i>
Giant ragweed	<i>Ambrosia trifida</i>
Giant reed	<i>Arundo donax</i>
Glassworts	<i>Salicornia</i> spp.
Goose grass	<i>Eleusine indica</i>

(Sheet 6 of 18)

Table E-1 (Continued)

Common Name	Scientific Name
Gray dogwood	<i>Cornus racemosa</i>
Green ash	<i>Fraxinus pennsylvanica</i>
Green bristlegrass	<i>Setaria viridis</i>
Ground blueberry	<i>Vaccinium myrsinites</i>
Groundsel tree	<i>Baccharis haminiifolia</i>
Gulf cordgrass	<i>Spartina spartinae</i>
Gum plant	<i>Grindelia integrifolia</i>
Hackberry	<i>Celtis occidentalis</i>
Halberd-leaved willow	<i>Salix hastata</i>
Hairy vetch	<i>Vicia hirsuta</i>
Hardstem bulrush	<i>Scirpus acutus</i>
Hemp sesbania	<i>Sesbania exaltata</i>
Hibiscus	<i>Hibiscus mascheutos</i>
Hickories	<i>Carya</i> spp.
Highbush blueberry	<i>Vaccinium corymbosum</i>
Hollyleaf cherry	<i>Prunus ilicifolia</i>
Honeylocust	<i>Gleditsia triacanthos</i>
Honey mesquite	<i>Prosopis juliflora</i>
Hooker's willow	<i>Salix hookeriana</i>
Hop clover	<i>Trifolium procumbens</i>
Horned pondweed	<i>Zannichellia palustris</i>
Horse nettle	<i>Solanum carolinense</i>
Horsetails	<i>Equisetum</i> spp.
Horseweed	<i>Erigeron canadensis</i>
Ice plant	<i>Mesembryanthemum crystallinum</i>
Italian ryegrass	<i>Lolium multiflorum</i>
Japanese clover	<i>Lespedeza striata</i>
Japanese honeysuckle	<i>Lonicera japonica</i>

(Sheet 7 of 18)

Table E-1 (Continued)

Common Name	Scientific Name
Japanese lespedeza	<i>Lespedeza japonica</i>
Japanese millet	<i>Echinochloa crusgalli</i> hybrid
Jerusalem artichoke	<i>Helianthus tuberosus</i>
Johnson grass	<i>Sorghum halepense</i>
Jungle rice	<i>Echinochloa colonum</i>
Korean clover	<i>Lespedeza stipulacea</i>
Kudzu	<i>Pueraria lobata</i>
Ladino clover	<i>Trifolium repens latum</i>
Ladysthumb	<i>Polygonum persicaria</i>
Lanceleaf greenbrier	<i>Smilax smallii</i>
Large crabgrass	<i>Digitaria sanguinalis</i>
Laurel oak	<i>Quercus laurifolia</i>
Lespedeza	<i>Lespedeza</i> spp.
Lettuce	<i>Lactuca sativa</i>
Little hairgrass	<i>Aira praecox</i>
Live oak	<i>Quercus virginiana</i>
Lizard's tail	<i>Saururus cernuus</i>
Lobelia	<i>Lobelia dartmannia</i>
Loblolly pine	<i>Pinus taeda</i>
Longleaf pine	<i>Pinus palustris</i>
Lotus	<i>Nelumbo lutea</i>
Low blueberry	<i>Vaccinium vacillans</i>
Lupine	<i>Lupinus polyphyllus</i>
Lyngbye's sedge	<i>Carex lyngbyei</i>
Malta starthistle	<i>Centaurea melitensis</i>
Manna grass	<i>Glyceria acutiflora</i>
Manna grass	<i>Glyceria fluitans</i>
Mapleleaf goosefoot	<i>Chenopodium hybridum</i>

(Sheet 8 of 18)



Table E-1 (Continued)

Common Name	Scientific Name
Mapleleaf viburnum	<i>Viburnum acerifolium</i>
Marsh elder	<i>Iva frutescens</i>
Marsh hibiscus	<i>Hibiscus moscheutos</i>
Marsh pea	<i>Lathyrus palustris</i>
Marsh pepper	<i>Polygonum hydropiper</i>
Marsh smartweed	<i>Polygonum hydropiperoides</i>
Maximillian's sunflower	<i>Helianthus maximilliani</i>
Mexican tea	<i>Chenopodium ambrosioides</i>
Millets	<i>Echinochloa</i> spp.
Mockernut hickory	<i>Carya tomentosa</i>
Mountain blackberry	<i>Rubus allegheniensis</i>
Mud plantain	<i>Plantago reniformis</i>
Multiflora rose	<i>Rosa multiflora</i>
Muscadine grape	<i>Vitis rotundifolia</i>
Musk filaree	<i>Erodium moschatum</i>
Myrtle oak	<i>Quercus myrtifolia</i>
Narrowleaf vetch	<i>Vicia angustifolia</i>
Nodding smartweed	<i>Polygonum lapathifolium</i>
Northern bayberry	<i>Myrica pennsylvanica</i>
Nutsedges	<i>Cyperus</i> spp.
Oaks	<i>Quercus</i> spp.
Oats	<i>Avena sativa</i>
Oleander	<i>Nerium oleander</i>
Olney's three-square	<i>Scirpus olneyi</i>
Orache	<i>Atriplex patula</i>
Orchardgrass	<i>Dactylis glomerata</i>
Pacific bayberry	<i>Myrica californica</i>
Pacific cordgrass	<i>Spartina pacifica</i>

(Sheet 9 of 18)

Table E-1 (Continued)

Common Name	Scientific Name
Pacific dogwood	<i>Cornus nuttallii</i>
Pacific glasswort	<i>Salicornia pacifica</i>
Pacific sedge	<i>Carex obnupta</i>
Pacific wax myrtle	<i>Myrica californica</i>
Pacific willow	<i>Salix lasiandra</i>
Palmetto	<i>Serena repens</i>
Panic grasses	<i>Panicum</i> spp.
Paper mulberry	<i>Broussonetia papyrifera</i>
Partridge pea	<i>Cassia fasciculata</i>
Peach	<i>Persea</i> spp.
Peachleaf willow	<i>Salix amygdaloides</i>
Pear	<i>Persea</i> spp.
Pearl millet	<i>Pennisetum glaucum</i>
Peas	<i>Vigna</i> spp.
Pecan	<i>Carya illinoensis</i>
Pennsylvania smartweed	<i>Polygonum pensylvanicum</i>
Peppervine	<i>Ampelopsis arborea</i>
Perennial ryegrass	<i>Lolium perenne</i>
Persimmon	<i>Diospyros virginiana</i>
Pickleweeds	<i>Salicornia</i> spp.
Pignut hickory	<i>Carya glabra</i>
Poison ivy	<i>Rhus radicans</i>
Pokeberry	<i>Phytolacca americana</i>
Pondweeds	<i>Potamogeton</i> spp.
Possumhaw	<i>Ilex decidua</i>
Possumhaw viburnum	<i>Viburnum nudum</i>
Prairie cordgrass	<i>Spartina pectinata</i>
Proso millet	<i>Panicum miliaceum</i>

(Sheet 10 of 18)

Table E-1 (Continued)

Common Name	Scientific Name
Prostrate knotweed	<i>Polygonum aviculare</i>
Prostrate spurge	<i>Euphorbia supina</i>
Purple loosestrife	<i>Lythrum salicaria</i>
Purple nutsedge	<i>Cyperus rotundus</i>
Purple osier willow	<i>Salix purpurea</i>
Purple vetch	<i>Vicia americanus</i>
Pussy willow	<i>Salix discolor</i>
Potatoes	<i>Solanum tuberosum</i>
Quack grass	<i>Agropyron repens</i>
Quail brush	<i>Atriplex lentiformis</i>
Red alder	<i>Alnus rubra</i>
Redbay	<i>Persea borbonia</i>
Red buckeye	<i>Aesculus parvia</i>
Red clover	<i>Trifolium pratense</i>
Red mangrove	<i>Rhizophora mangle</i>
Red maple	<i>Acer rubrum</i>
Red mulberry	<i>Morus rubra</i>
Red osier dogwood	<i>Cornus stolonifera</i>
Red fescue	<i>Festuca rubra</i>
Red-rooted sedge	<i>Cyperus erythrorhizos</i>
Redroot pigweed	<i>Amaranthus retroflexus</i>
Redtop	<i>Agrostis alba</i>
Reed canary grass	<i>Phalaris arundinacea</i>
Reed grass	<i>Calamogrostis canadensis</i>
Reed manna grass	<i>Glyceria grandis</i>
Rescue grass	<i>Bromus catharticus</i>
Reseeding soybean	<i>Glycine ussuriensis</i>
Rice	<i>Oryza sativa</i>

(Sheet 11 of 18)

Table E-1 (Continued)

Common Name	Scientific Name
Rice cutgrass	<i>Leersia oryzoides</i>
River birch	<i>Betula nigra</i>
River bulrush	<i>Scirpus fluviatilis</i>
Riverflat hawthorn	<i>Crateagus opaca</i>
Rough-leaved dogwood	<i>Cornus drummondii</i>
Rushes	<i>Juncus</i> spp.
Russian olive	<i>Elaeagnus angustifolia</i>
Rusty blackhaw	<i>Viburnum rufidulum</i>
Rye	<i>Secale cereale</i>
Salal	<i>Gautheria shallon</i>
Salmonberry	<i>Rubus spectabilis</i>
Saltbush	<i>Atriplex polycarpa</i>
Saltcedar	<i>Tamarisk parviflora</i>
Saltgrass	<i>Distichlis spicata</i>
Saltmarsh aster	<i>Aster tenuifolius</i>
Saltmarsh bulrush	<i>Scirpus robustus</i>
Saltmarsh cattail	<i>Typha angustifolia</i>
Saltmarsh jaumea	<i>Jaumea carnosa</i>
Saltmeadow cordgrass	<i>Spartina patens</i>
Saltwort	<i>Salsola kali</i>
Sandbar willow	<i>Salix interior</i>
Sand blackberry	<i>Rubus cuneifolius</i>
Sand dropseed	<i>Sporobolus cryptandrus</i>
Sand pine	<i>Pinus clausa</i>
Sassafras	<i>Sassafras albidum</i>
Saw grass	<i>Cladium jamaicense</i>
Sawbrier	<i>Smilax glauca</i>
Sawtooth oak	<i>Quercus acutissima</i>

(Sheet 12 of 18)

Table E-1 (Continued)

Common Name	Scientific Name
Schweinitz's nutsedge	<i>Cyperus schweinitzii</i>
Scotch broom	<i>Cytisus scoparius</i>
Sea blite	<i>Suaeda maritima</i>
Sea lavender	<i>Limonium carolinianum</i>
Sea lavender	<i>Limonium vulgare</i>
Sea oats	<i>Uniola paniculata</i>
Sea ox-eye	<i>Borrichia frutescens</i>
Seaside arrowgrass	<i>Triglochin maritima</i>
Seaside dock	<i>Rumex maritima</i>
Seaside goldenrod	<i>Solidago sempervirens</i>
Seaside plantain	<i>Plantago maritima</i>
Seashore bluegrass	<i>Poa macantha</i>
Seashore lupine	<i>Lupinus littoralis</i>
Seashore paspalum	<i>Paspalum vaginatum</i>
Sedges	<i>Carex</i> spp.
Sericea lespedeza	<i>Lespedeza sericea</i>
Sharp-toothed blackberry	<i>Rubus argutus</i>
Sheep sorrel	<i>Rumex acetosella</i>
Shining sumac	<i>Rhus copallina</i>
Shoal grass	<i>Halodule wrightii</i>
Shoredune panic grass	<i>Panicum amarulum</i>
Shore pine	<i>Pinus contorta</i>
Showy tick-trefoil	<i>Desmodium candense</i>
Shrub verbena	<i>Lantana camera</i>
Silky dogwood	<i>Cornus amomum</i>
Silky willow	<i>Salix sericea</i>
Silverleaf croton	<i>Croton punctatus</i>
Sitka alder	<i>Alnus sinuata</i>

(Sheet 13 of 18)

Table E-1 (Continued)

Common Name	Scientific Name
Sitka spruce	<i>Picea sitchensis</i>
Sixweeks fescue	<i>Festuca octoflora</i>
Slash pine	<i>Pinus elliottii</i>
Slough grass	<i>Beckmannia syzigachne</i>
Slough sedge	<i>Carex trichocarpa</i>
Smartweeds	<i>Polygonum</i> spp.
Smooth cordgrass	<i>Spartina alterniflora</i>
Smooth crabgrass	<i>Digitaria ischaemum</i>
Smooth sumac	<i>Rhus glabra</i>
Soft rush	<i>Juncus effusus</i>
Softstem bulrush	<i>Scirpus validus</i>
Sorghum	<i>Sorghum vulgare</i>
Southern bayberry	<i>Myrica cerifera</i>
Southern bulrush	<i>Scirpus californicus</i>
Southern cutgrass	<i>Zizaniopsis mileacea</i>
Southern dewberry	<i>Rubus trivialis</i>
Southern ragweed	<i>Ambrosia bidentata</i>
Southern red oak	<i>Quercus falcata</i>
Southern smartweed	<i>Polygonum densiflorum</i>
Soybean	<i>Glycine max</i>
Sparkleberry	<i>Vaccinium arboreum</i>
Spatterdock	<i>Nympha lutum</i>
Spikerushes	<i>Eleocharis</i> spp.
Spirodella	<i>Spirodella polyrhiza</i>
Spotted burclover	<i>Medicago arabica</i>
Spotted spurge	<i>Euphorbia maculata</i>
Sprangletop	<i>Leptochloa fascicularis</i>
Squarestem spikerush	<i>Eleocharis quadrangulata</i>

(Sheet 14 of 18)

Table E-1 (Continued)

Common Name	Scientific Name
Squash	<i>Cucurbita</i> spp.
Squaw huckleberry	<i>Vaccinium stamineum</i>
Staghorn sumac	<i>Rhus typhina</i>
Sudan grass	<i>Sorghum sudanese</i>
Sugarberry	<i>Celtis laevigata</i>
Sugar maple	<i>Acer saccharum</i>
Summersweet	<i>Clethra alnifolia</i>
Sunflower	<i>Helianthus giganteus</i>
Supplejack	<i>Berchemia scandens</i>
Swamp privet	<i>Forestiera acuminata</i>
Swamp rose	<i>Rosa palustris</i>
Sweetbay	<i>Magnolia virginiana</i>
Sweet flag	<i>Acorus calamis</i>
Sweet gum	<i>Liquidambar styraciflua</i>
Switchgrass	<i>Panicum virgatum</i>
Tag alder	<i>Alnus serrulata</i>
Tall fescue	<i>Festuca arundinacea</i>
Tansy mustard	<i>Descurainia pinnata</i>
Tartarian honeysuckle	<i>Lonicera tatarica</i>
Telegraph weed	<i>Heterotheca graniflora</i>
Texas huisache	<i>Acacia smallii</i>
Texas millet	<i>Panicum texanum</i>
Thorny eleagnus	<i>Elaeagnus pungens</i>
Timothy	<i>Phleum pratense</i>
Tomato	<i>Lycopersicon esculentum</i>
Toothache tree	<i>Zanthoxylum clava-herculis</i>
Torpedo grass	<i>Panicum repens</i>
Tropic croton	<i>Croton glandulosus</i>

(Sheet 15 of 18)

Table E-1 (Continued)

Common Name	Scientific Name
Tufted hairgrass	<i>Deschampsia caspitosa</i>
Tulip poplar	<i>Liriodendron tulipifera</i>
Tumbleweed	<i>Amaranthus albus</i>
Tupelo gum	<i>Nyssa aquatica</i>
Turkey oak	<i>Quercus laevis</i>
Turtle grass	<i>Thlassia testudinum</i>
Vasey grass	<i>Paspalum urvillei</i>
Virginia creeper	<i>Parthenocissus quinquefolia</i>
Virginia dropseed	<i>Sporobolus virginicus</i>
Virginia pepperweed	<i>Lepidium virginicum</i>
Walter's millet	<i>Echinochloa walterii</i>
Water hemp	<i>Acnida cannabina</i>
Water hyssop	<i>Bacopa caroliniana</i>
Water lilies	<i>Nymphaea</i> spp.
Watermilfoils	<i>Myriophyllum</i> spp.
Water nymphs	<i>Najas</i> spp.
Water oak	<i>Quercus nigra</i>
Water plantain	<i>Plantago aquatica</i>
Water primrose	<i>Jussiaea leptocarpa</i>
Water shield	<i>Brasenia schriberi</i>
Water smartweed	<i>Polygonum amphibum</i>
Water willow	<i>Decodon verticillatus</i>
Wax myrtle	<i>Myrica cerifera</i>
Western blackberry	<i>Rubus vitifolia</i>
Western chokecherry	<i>Prunus virginiana dimissa</i>
Western dogwood	<i>Cornus occidentalis</i>
Western huckleberry	<i>Vaccinium ovatum</i>
Western ragweed	<i>Ambrosia psilostachya</i>

(Sheet 16 of 18)



Table E-1 (Continued)

Common Name	Scientific Name
Wheat	<i>Triticum aestivum</i>
White ash	<i>Fraxinus americana</i>
White clover	<i>Trifolium repens</i>
White mangrove	<i>Laguncluararia racemosa</i>
White oak	<i>Quercus alba</i>
White poplar	<i>Populus alba</i>
White sweetclover	<i>Melilotus alba</i>
Widgeongrass	<i>Ruppia maritima</i>
Wild apple	<i>Malus pumila</i>
Wild bamboo	<i>Smilax auriculata</i>
Wild bean	<i>Strophostyles helvola</i>
Wild black currant	<i>Ribes americanum</i>
Wild buckwheat	<i>Polygonum convolvulus</i>
Wild celery	<i>Vallisneria americana</i>
Wild cherry	<i>Prunus emarginata</i>
Wild indigo	<i>Baptisia leucophaea</i>
Wild rice	<i>Zizania aquatica</i>
Wild rose	<i>Rosa rugosa</i>
Wild rye	<i>Elymus virginicus</i>
Wild sensitive pea	<i>Cassia nictitans</i>
Wild strawberry	<i>Fragaria virginiana</i>
Willows	<i>Salix</i> spp.
Wingscale	<i>Atriplex canescens</i>
Winterberry	<i>Ilex verticillata</i>
Witch hazel	<i>Hammamelis virginiana</i>
Wolffias	<i>Wolffia</i> spp.
Woolly croton	<i>Croton capitata</i>
Woolly indianwheat	<i>Plantago purshii</i>

(Sheet 17 of 18)

Table E-1 (Continued)

Common Name	Scientific Name
Woolly panic grass	<i>Panicum lanuginosum</i>
Yaupon	<i>Ilex vomitoria</i>
Yellow bristlegrass	<i>Setaria lutescens</i>
Yellow flag	<i>Iris versicolor</i>
Yellow paloverde	<i>Centaurea solstitialis</i>
Yellow starthistle	<i>Cercidium microphyllum</i>
Yellow sweetclover	<i>Melilotus officinalis</i>

(Sheet 18 of 18)

E.2 Animals. Table E-2 identifies both the common and the scientific names of the animals mentioned in this manual.

Table E-1. Common and Scientific Names of the Animals Mentioned in this Manual

Common Name	Scientific Name
Bait shrimp	<i>Penaeus</i> spp.
Black-necked stilt	<i>Himantopus mexicanus</i>
Black skimmer	<i>Rynchops niger</i>
Blue crab	<i>Callinectes sapidus</i>
Brown pelican	<i>Pelenacus occidentalis</i>
California grunion	<i>Leuresthes tenuis</i>
Canada goose	<i>Branta canadensis</i>
Cat (feral)	<i>Felis catus</i>
Catfish	<i>Ictalurus</i> spp.
Cattle	<i>Bos taurus</i>
Clams	Pelecypoda
Clapper rail	<i>Rallus longirostris</i>
Common tern	<i>Sterna hirundo</i>

(Sheet 1 of 3)

Table E-2 (Continued)

Common Name	Scientific Name
Cormorants	<i>Phalacrocorax</i> spp.
Coyote	<i>Canis latrans</i>
Crayfish	Astacidae
Dog (feral)	<i>Canis domesticus</i>
Dusky jawfish	<i>Opistognathus whitehursti</i>
Fiddler crab	<i>Uca pugnax</i>
Foxes	<i>Vulpes</i> spp.
Goats (feral)	<i>Capra hircus</i>
Gull-billed tern	<i>Gelochelidon nolutica</i>
Gulls	<i>Larus</i> spp.
Killdeer	<i>Charadrius vociferus</i>
Laughing gull	<i>Larus atricilla</i>
Least tern	<i>Sterna albifrons</i>
Marsh rabbit	<i>Sylvilagus</i> spp.
Minnnows	Cyprinidae
Muskrat	<i>Ondatra zibethica</i>
Mussels	Pelecypoda
Nutria	<i>Myocastor coypus</i>
Oyster	<i>Crassostea virginica</i>
Peregrine falcon	<i>Falco peregrinus</i>
Prawns	Palaemonidae
Rabbits	<i>Syvalagus</i> spp.
Raccoon	<i>Procyon lotor</i>
Rails	<i>Rallus</i> sp.
Redfish	<i>Sebastes marinus</i>
Roseate spoonbill	<i>Ajaia ajaja</i>
Sheep	<i>Ovis aries</i>
Shrimp	<i>Penaeus</i> spp.

(Sheet 2 of 3)

Table E-2 (Continued)

Common Name	Scientific Name
Striped bass	<i>Morone saxatilis</i>
Terns	<i>Sterna</i> spp.
Trout	<i>Salmo</i> spp.
White pelican	<i>Pelecanus erythrorhynchos</i>
White shrimp	<i>Penaeus setiferus</i>
White-tailed deer	<i>Odocoileus virginiana</i>

(Sheet 3 of 3)

## APPENDIX F

### Automated Dredging and Disposal Alternatives Modeling System (ADDAMS)

F.1 Purpose. This appendix presents information from Technical Note EEDP-06-12 (Schroeder et al. 2004), which describes the capabilities and availability of the Automated Dredging and Disposal Alternatives Modeling System (ADDAMS). The technical note may be read in its entirety at <http://el.erdc.usace.army.mil/elpubs/pdf/eedp06-12.pdf>.

F.2 Background. Planning, design, and management of dredging and dredged material placement projects often require complex or tedious calculations or involve complex decision-making criteria. In addition, the evaluations must often be done for several placement alternatives or placement sites. ADDAMS is a PC-based system developed to assist users in making such evaluations in a timely manner. It includes a collection of applications designed to assist in managing dredging projects. This appendix describes the system, currently available applications, mechanisms for acquiring and running the system, and provisions for revision and expansion.

### F.3 Description of ADDAMS.

F.3.1 Objective. ADDAMS is an interactive PC-based design and analysis system for dredged material management. It is composed of individual modules or applications, each of which has computer programs designed to assist in the evaluation of a specific aspect of a dredging project. The system was developed in response to requests by USACE field offices for tools to evaluate dredged material management alternatives more quickly. The objective of ADDAMS is to provide state-of-the-art computer-based tools that will increase the accuracy, reliability, and cost-effectiveness of USACE dredged material management activities in a timely manner.

#### F.3.2 Available applications.

F.3.2.1 Reflecting the nature of dredged material management activities, the applications contained in ADDAMS and their methodologies are richly diverse in sophistication and origin. The contents range from simple algebraic expressions, both theoretical and empirical in origin, to numerically intense algorithms spawned by the increasing power and affordability of computers.

F.3.2.2 Figure F-1 shows the currently available applications under the ADDAMS umbrella. Initially, the ADDAMS applications were all written for DOS-based computers. The most frequently used applications have either been converted or are currently in the process of being converted for 64-bit Windows operating systems. Figure F-1 shows the current mix of DOS-based and Windows-based applications. They are divided into two groups: dredged material management and environmental effects evaluation.

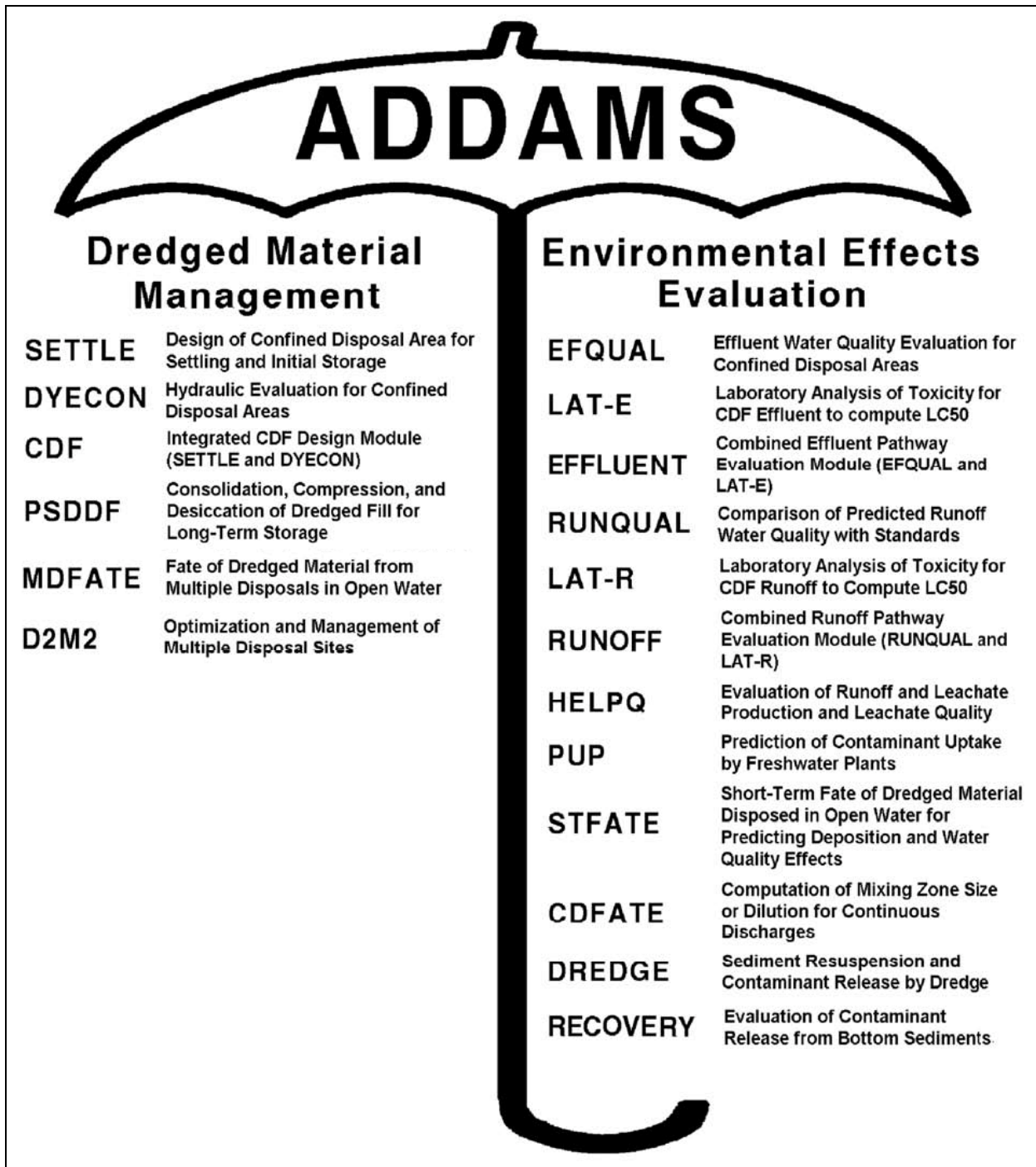

Figure F-1. Current Applications in ADDAMS

F.3.2.3 A summary description of each ADDAMS application, including a listing of capabilities and technical points of contact, is found in Section F-6. As applications are updated or new applications are added, Technical Note EEDP-06-12 will be updated by changes to this technical note. A demo that includes SETTLE, DYECON, PSDDF, STFATE, D2M2, EFQUAL,

RUNQUAL, and HELPQ is available at <http://el.erdc.usace.army.mil/products.cfm?Topic=model&Type=drpmat>.

F.3.2.4 Each ADDAMS application has documentation describing how to run that it; Schroeder et al. (2004) is intended to serve as the user's guide and documentation for the overall ADDAMS system. All ADDAMS files are available at <http://el.erdc.usace.army.mil/products.cfm?Topic=model&Type=drpmat>. A detailed list of references is provided both in Schroeder et al. (2004) and directly onscreen within the applications, including those concerned with the technical background and theory involved and documentation for the programming as appropriate. Points of contact for each application are also listed directly on the screens for answering questions regarding the respective applications.

#### F.4 General Instructions.

F.4.1 Target Hardware Environment. The strong preference of USACE field offices is for the system to reside in a commonly available desktop hardware environment. The system is, therefore, designed for PCs resident at USACE field offices, running Windows operating systems. Since components of ADDAMS have been developed over a number of years, different components were designed for different operating systems. Early components were designed to run in DOS; later components were designed for Windows 95 and 98 and, subsequently, Windows XP. Upgrades are currently being prepared for Windows 7.

##### F.4.2 Installation and Startup.

F.4.2.1 On the ADDAMS website, each ADDAMS application has a program file that is a self-extracting compressed archive of the application's installation routine. Download the file into a temporary subdirectory on your computer; then run the program file to extract the installation files. After the files have been extracted, double-click the INSTALL.EXE file to install the application. If you download more than one application program, you must both extract and install each application before extracting the next program file; otherwise, the program files should be downloaded to different subdirectories.

F.4.2.2 It is recommended that the ADDAMS files be saved in a directory dedicated for the ADDAMS system on your workstation's hard disk (for example, C:\ADDAMS).

F.4.2.2.1 To begin a session using one of the DOS-based applications, go to the DOS or command prompt, make the ADDAMS directory the current default directory, and type ADDAMS or the name of the application. In Windows, you can start a DOS-based application by using either the Run command or the Open option to execute the application batch file (\*.BAT). Menus will then be displayed.

F.4.4.2.2 To begin a session using one of the Windows-based applications, double-click the appropriate icon on the desktop.

F.4.2.3 Note that ADDAMS supporting documents are also available on the ADDAMS website. The available documents are in Adobe Acrobat format (PDF). Download the document files into any subdirectory. View or print the documents using Adobe Reader.

#### F.4.3 User Interface.

F.4.3.1 The DOS version applications are SETTLE, DYECON, PSDDF, STFATE, CDFATE, MDFATE, D2M2, EFQUAL, LAT-E, RUNQUAL, LAT-R, HELPQ, PUP, and RECOVERY.

F.4.3.2 These DOS applications employ a menu-driven environment and support full-screen data entry. Single keystrokes (usually the F1-F10 function keys, number keys, Esc key, cursor keys, and Enter key) select menu options in the system. The vast majority of these applications do not use mouse controls.

F.4.3.3 Cursor keys highlight input fields (displayed in reverse video) much like a spreadsheet program. To enter alphanumeric data, move the cursor to the cell of interest using the Up or Down arrows to move vertically and the Tab and Shift+Tab keys to move horizontally. The Enter key moves forward through the cells. The Left and Right arrow keys can be used to move the cursor within a selected cell in order to edit the cell contents. The Backspace key deletes characters in a cell. The space bar inserts spaces in a cell. The Delete and Insert keys, respectively, delete and insert a row of data on a screen of tabular data.

F.4.3.4 Page Down moves the cursor to the next screen of data entry and the Page Up key moves the cursor to the previous screen of data entry. The End key or Esc key allows you to quit data entry and exit the application without saving the data. The Home key exits the current data entry activity screen to the activity selection menu for the application and retains the entered data in memory.

F.4.3.5 More recent ADDAMS applications (DREDGE, CDF, EFFLUENT, and RUNOFF) have been written in Windows format with all the Windows programs except DREDGE supporting all Windows operating systems (95/98, NT, 2000 and XP). DREDGE operates only in Windows 95/98 and XP. Online help is available. In addition, Windows versions of STFATE, CDFATE, and RECOVERY are available, and a Windows version of PSDDF and CAP (a combination of RECOVERY and PSDDF) are being prepared. Results from computations are generally displayed in tabular or graphic format on the screen or written to print files or devices.

#### F.4.4 Applications and File Management.

F.4.4.1 Each ADDAMS application consists of one or more stand-alone computer programs or numerical models to perform a specific analysis. ASCII files store input data from previous runs and are used to store output of results. The DOS version of ADDAMS displays an initial menu of applications. Once an application is selected, an activity selection menu will be displayed at several levels for entering and editing data, executing the application, printing the results, performing file operations, and exiting the program.



F.4.4.2 The File Manager is accessible within each application. The File Manager acts only on data files for the selected application. The File Manager can select, name, or copy files, or display a directory listing the files.

F.4.4.3 The Windows applications of ADDAMS employ standard Windows file management methods including a File option drop-down menu and icons on the toolbar to open new or existing files and print or save data.

F.4.5 Printing. A hard copy of input data, output of results, data files, and file directories can be printed in both DOS and Windows applications. The DOS commands Control+Print Screen and Shift+Print Screen can also be used to print, respectively, all information written to the screen or currently on the monitor. Many of the print functions of the DOS applications do not work in a Windows environment; however, the Print Screen functions operate when the DOS applications are run from a window as opposed to full screen. The screen captures can be printed in word processing or presentation/graphics software. The output files from the DOS applications can be printed from any Windows application for ASCII files, such as Notepad, Wordpad, or Word using fixed (non-scalable) fonts.

F.4.6 Ending. Normal termination is recommended at all times to avoid data loss.

a. For DOS applications, terminate data entry by paging from the data entry screens or pressing the Home key to return to the activity selection menu. Press the Esc key or the function key for file operations to save the data, and then press the Esc key to exit each menu and return, ultimately, to DOS. Note that it is sometimes necessary to wait for lengthy computations to complete before exiting. A program can also be terminated by pressing Control+Break, ending the task, closing the window, or turning off the computer, but these methods of ending are not recommended because data may be lost.

b. For Windows applications, use the Save or Save As command in the File menu before closing a window or exiting the application.

F.5 Availability of ADDAMS. The ADDAMS system and applications are available on the Internet at <http://el.erdc.usace.army.mil/products.cfm?Topic=model&Type=drmat>. For users who do not have Internet access, a request form for obtaining the ADDAMS applications on CD is provided in Schroeder et al. (2004).

#### F.6 Revisions, Updates, and Workshops.

F.6.1 The ADDAMS applications will be revised and updated as new technical approaches become available, and new applications will be developed to address additional management needs. Each application is designed as a module so that revisions or the addition of new applications can be easily accomplished. The ADDAMS website has the most current version of each application. Version numbers are displayed on-screen for the ADDAMS system and the various applications. Periodically, a new version of the entire system may be required.

31 Jul 15

F.6.2 Changes to Schroeder et al. (2004) will provide information on new applications. In addition, workshops are held on an as-needed basis to familiarize USACE personnel with use of the ADDAMS system. Also, upon request, workshops can be held within a District to provide training on specific applications needed for a particular project. Requests for additions to the mailing list for the technical note series and inquiries regarding the scheduling of ADDAMS workshops should be sent to the following address:

USACE Research and Development Center, Waterways Experiment Station  
ATTN: CEERD-EM-D  
3909 Halls Ferry Road  
Vicksburg, MS 39180-6199

#### F.7 Description of ADDAMS Applications.

F.7.1 Design of Confined Disposal Facilities for Suspended Solids Retention and Initial Storage Requirements (SETTLE) application (DOS).

F.7.1.1 Description. Confined disposal facilities (CDFs) must be designed to provide both the storage volume required for the dredged solids and the hydraulic retention time for removal of suspended solids from the effluent discharged from the area during hydraulic filling operations. Various settling processes occurring in the CDF control the initial storage during filling, clarification, and effluent suspended solids. This application assists users in designing a CDF for solids retention and initial storage in accordance with the design procedures in this EM. Laboratory column settling tests are an integral part of these design procedures, and the data from these tests are required in order to use this application. The SETTLE application analyzes laboratory data from the settling tests and calculates design parameters for CDFs.

F.7.1.2 Major Capabilities. SETTLE has the following capabilities:

- a. Analyzes laboratory settling test data for zone, flocculant, and compression settling.
- b. Determines the maximum allowable in situ volume that can be dredged and placed in a CDF with a given available storage volume.
- c. Determines the maximum allowable dredge size (or inflow rate) that can be used with a given CDF surface area and ponding volume to obtain clarification and maintain satisfactory retention of suspended solids.
- d. Determines the required CDF surface area and volume to accommodate a given dredge size and a given in situ volume to be dredged.
- e. Determines the required weir crest length for a given dredge size.

F.7.1.3 Current Version: 3.00 updated October 1995.

F.7.1.4 Point of Contact: Dr. Paul R. Schroeder, CEERD-EP-E, (601) 634-3709.

## F.7.2 Determination of Hydraulic Retention Time and Efficiency of Confined Disposal Facilities (DYECON) application (DOS).

F.7.2.1 Description. This application determines mean hydraulic retention time and hydraulic efficiency of a CDF from a dye tracer slug test. Determination of retention time of ponded water is an important aspect of CDF design. Dye tracer studies may be undertaken to provide retention time data for large sites or those with unusual characteristics. Procedures for conducting such dye tracer tests are presented in Appendix P, "Dye Tracer Technique to Estimate Mean Residence Time and Hydraulic Efficiency." In the absence of dye tracer data, the hydraulic efficiency can be estimated empirically.

F.7.2.2 Major Capabilities. DYECON has the following capabilities:

- a. Determines the theoretical and mean retention times of a CDF and the resulting hydraulic efficiency.
- b. Determines the mean and maximum dye concentrations, time of peak dye concentration, and related characteristics of the dye concentration curve.

F.7.2.3 Current Version: 3.00 updated June 1993.

F.7.2.4 Point of Contact: Dr. Paul R. Schroeder, CEERD-EP-E, (601) 634-3709.

## F.7.3 CDF Design Module (CDF) application (Windows).

F.7.3.1 Description. The CDF application has all the basic components of both the SETTLE and DYECON modules already described, but it was written for Windows operating systems. CDF has an intuitive, easy-to-use graphical user interface for data entry, an on-line help system, and a design wizard for evaluating various design scenarios.

F.7.3.2 Major Capabilities. CDF has the following capabilities:

- a. Determines the theoretical and mean retention times of a CDF and the resulting hydraulic efficiency.
- b. Analyzes laboratory settling test data for zone, flocculant, and compression settling.
- c. Determines the maximum allowable in situ volume that can be dredged and placed in a CDF with a given available storage volume.
- d. Determines the maximum allowable dredge size (or inflow rate) that can be used with a given CDF surface area and ponding volume to obtain clarification and maintain satisfactory retention of suspended solids.
- e. Determines the required CDF surface area and volume to accommodate a given dredge size and a given in situ volume to be dredged.

- f. Determines the required weir crest length for a given dredge size.

F.7.3.3 Current Version: 1.00.

F.7.3.4 Point of Contact: Dr. Paul R. Schroeder, CEERD-EP-E, (601) 634-3709.

F.7.4 Evaluation of Primary Consolidation, Secondary Compression, and Desiccation of Dredged Fill (for Determining Long-Term Storage Requirements) (PSDDF) Application (DOS).

F.7.4.1 Description. This application provides a mathematical model to estimate the storage volume occupied by a layer or layers of dredged material in a CDF as a function of time. Management of CDFs to provide maximum storage capacity is becoming more necessary as both the storage capacity of existing sites and availability of land for new sites decrease. Maximum site capacity is achieved through densification of the dredged material by removal of interstitial water. The volume reduction and the resulting increase in storage capacity are obtained through both consolidation and desiccation (drying) of the dredged material. PSDDF can also simulate underwater placement of cohesive or noncohesive soil. PSDDF relies on the results of laboratory consolidation tests to estimate the magnitude and rate of consolidation and on climatic data for estimation of the rates of drying at a given site. The predictive procedures are described in Appendix L, "Estimation of Dredged material Consolidation by Finite Strain Technique," and Appendix N, "Monthly Standard Class 'A' Pan Evaporation for the Continental United States."

F.7.4.2 Major Capabilities. PSDDF has the following capabilities:

- a. Determines the final or ultimate thickness and elevation of multiple lifts of dredged material placed at given time intervals.

- b. Determines the time rate of settlement for multiple lifts and, therefore, the surface elevation of the dredged material fill as a function of time.

- c. Determines the water content, void ratio, total and effective stress, and pore pressure for multiple lifts as a function of time.

F.7.4.3 Current Version: 2.1 updated November 1996; an update is currently being prepared.

F.7.4.4 Point of Contact: Dr. Paul R. Schroeder, CEERD-EP-E, (601) 634-3709.

F.7.5 System Optimization for Regional Dredging and Dredged Material Disposal (D2M2) application (DOS).

F.7.5.1 Description. This application provides the Dredged-Material Disposal Management Model (D2M2), developed by the U.S. Army Engineer Hydrologic Engineering Center (HEC), a simulation-optimization model for systematic analysis of long-term operation and expansion of multiple placement sites. The model provides a means of determining the optimum usage of multiple placement areas to meet the dredging requirements at multiple dredging sites, for example, along the length of a navigation channel. D2M2 uses a linear-optimization approach in

determining the optimum usage based on input data for dredging volumes, location, frequencies, transportation facilities, and associated costs.

F.7.5.2 Major Capabilities. D2M2 has the following capabilities:

a. Determines the optimum usage of multiple placement sites to meet dredging requirements at multiple dredging locations.

b. Identifies the minimum-net-cost, short-term operation policy for a system of placement sites and dredging areas.

c. Analyzes placement capacity expansion alternatives and determines the minimum cost placement site acquisition schedule.

F.7.5.3 Current Version: CESP (U.S. Army Engineer District, San Francisco), updated August 1995.

F.7.5.4 Points of Contact: Hydrologic Engineering Center, CEWRC-HEC, (916) 756-1104; Dr. Paul R. Schroeder, CEERD-EP-E, (601) 634-3709.

F.7.6 Prediction of Contaminant Uptake by Freshwater Plants (PUP) application (DOS).

F.7.6.1 Description. This application predicts metals uptake from dredged material by freshwater plants using DTPA (diethylenetriaminepentaacetic acid) extract data. The application compares the predictions with reference sites to determine the acceptability of the uptake in upland and flooded environments.

F.7.6.2 Major Capabilities. PUP has the following capabilities:

a. Provides a quick screening tool for metals uptake by freshwater plants by comparing database values to sediment test results.

b. Indicates contaminants of concern for further evaluation.

F.7.6.3 Current Version: 1.0 updated January 1990.

F.7.6.4 Points of Contact: Dr. Bobby L. Folsom, Jr., CEERD-EP, (601) 634-4297; Dr. Paul R. Schroeder, CEERD-EP-E, (601) 634-3709.

F.7.7 Hydraulic Evaluation of Leachate Production and Leachate and Quality (HELPO) application (DOS).

F.7.7.1 Description. This application couples the U.S. Environmental Protection Agency (USEPA) Hydrologic Evaluation of Landfill Performance (HELP) model with an equilibrium partitioning model for contaminant transport. The model estimates leachate production, collection, and leakage from upland confined dredged material disposal facilities and also estimates contaminant concentrations and mass fluxes in the leachate.

F.7.7.2 Major Capabilities. HELPQ has the following capabilities:

- a. Balances the water budget at the ground surface and then routes the infiltrated water and the available contaminants throughout the soil profile.
- b. Uses sand or gravel layers for lateral drainage or leachate collection and clay and synthetic materials as liners.
- c. Provides special treatment for estuarine sediments to simulate salt washout effects on contaminant partitioning.
- d. Accepts user-supplied sequential partitioning coefficients or calculates partitioning coefficients from user-supplied sequential batch leach data or column leach data.
- e. Calculates contaminant concentrations in the CDF profile, contaminant concentration and mass releases through the bottom of the CDF, and contaminant masses captured by leachate collection systems.

F.7.7.3 Current Version: 2.1 updated October 1999.

F.7.7.4 Point of Contact: Dr. Paul R. Schroeder, CEERD-EP-E, (601) 634-3709.

F.7.8 Analysis of Modified Elutriate Test Results for Prediction of Chemical Effluent Quality and Dilution Requirements for Confined Disposal Facilities—Effluent (Water) Quality (EFQUAL) application (DOS)

F.7.8.1 Description. This application provides a computer program to analyze the results of modified elutriate tests and predict the chemical quality of effluent discharged from CDFs during hydraulic filling operations. Such predictions are necessary to evaluate the acceptability of the effluent discharge under Section 404 of the Clean Water Act. The effluent may contain both dissolved and particle-associated contaminants. The modified elutriate test was developed for use in predicting both the dissolved and particle-associated concentrations of contaminants in the effluent. Results of the modified elutriate and column settling tests may be used to predict the total concentrations of contaminants for a given set of CDF operational conditions.

F.7.8.2 Major Capabilities. EFQUAL has the following capabilities:

- a. Computes predicted dissolved, particle-associated, and total concentrations of contaminants of the effluent.
- b. Compares predicted concentrations with given water quality criteria and standards and determines the required dilution, if any, in a mixing zone to meet the standards.

F.7.8.3 Current Version: 3.00 updated October 1995.

F.7.8.4 Point of Contact: Dr. Paul R. Schroeder, CEERD-EP-E, (601) 634-3709.

F.7.9 Laboratory Analysis of Toxicity for CDF Effluent to Compute LC50 (LAT-E) application (DOS).

F.7.9.1 Description. The Decision-Making Framework (DMF) for the management of dredged material has been developed and used at several sites (Lee et al. 1991). Among the many components of the DMF is effluent water quality, which is one pathway that is investigated when confined placement is considered. The LAT-E Program compares survival data for various aquatic organisms at several elutriate dilutions and computes the LC50 for the effluent. Using the LC50 and a mixing zone model, the toxicity of the discharge can be evaluated for compliance with water quality regulations.

F.7.9.2 Major Capability. LAT-E statistically analyzes survival data for various aquatic organisms from a suite of water column bioassay tests for acute toxicity in accordance with the guidance in the Inland Testing Manual (USEPA/USACE 1994).

F.7.9.3 Current Version: 1.00 updated February 1997.

F.7.9.4 Points of Contact: Dr. Dennis L. Brandon, CEERD-EP-R, (601) 634-2807; Dr. Paul R. Schroeder, CEERD-EP-E, (601) 634-3709.

F.7.10 Combined (EFQUAL and LAT-E) Effluent Pathway Evaluation Module—EFFLUENT application (Windows).

F.7.10.1 Description. The EFFLUENT application has all the basic components of both the EFQUAL and LAT-E modules already described and was written for Windows operating systems.

F.7.10.2 Major Capabilities. EFFLUENT has the following capabilities:

- a. Computes predicted dissolved, particle-associated, and total concentrations of contaminants of the effluent.
- b. Compares predicted concentrations with given water quality criteria and standards and determines the required dilution, if any, in a mixing zone to meet the standards.
- c. Statistically analyzes the survival data from a suite of water column bioassay tests for acute toxicity in accordance with the guidance in the Inland Testing Manual (USEPA/USACE 1994).

F.7.10.3 Current Version: 1.00 updated January 2000.

F.7.10.4 Points of Contact: Dr. Paul R. Schroeder, CEERD-EP-E, (601) 634-3709; Dr. Dennis L. Brandon, CEERD-EP-R, (601) 634-2807.

F.7.11 Comparison of Predicted Runoff Water Quality with Standards (RUNQUAL) application (DOS).

F.7.11.1 Description. This application provides a computer program to analyze the results of surface runoff quality tests and to predict the chemical quality of the surface runoff discharged from CDFs. Such predictions are necessary to evaluate the acceptability of the surface runoff under Section 404 of the Clean Water Act. The surface water runoff may contain both dissolved and particle-associated contaminants. Results of the surface runoff quality tests and the column settling tests may be used to predict the dissolved and total concentrations of contaminants for a given set of CDF operational conditions.

F.7.11.2 Major Capabilities. RUNQUAL has the following capabilities:

- a. Computes predicted dissolved and total contaminant concentrations in the surface runoff discharged from a confined placement site using surface runoff quality test data.
- b. Compares predicted surface runoff concentrations with specified water quality standards.
- c. Computes required dilutions of surface runoff discharge to meet specified water quality standards, considering background concentrations in the receiving water.

F.7.11.3 Current Version: 1.00 August 1993.

F.7.11.4 Point of Contact: Dr. Paul R. Schroeder, CEERD-EP-E, (601) 634-3709.

F.7.12 Laboratory Analysis of Toxicity for CDF Runoff to Compute LC50 (LAT-R) application (DOS).

F.7.12.1 Description. The Decision-Making Framework (DMF) for the management of dredged material has been developed and used at numerous USACE projects (Lee et al. 1991). Among the many components of the DMF is surface runoff water quality, which is one of the pathways investigated when confined placement is considered. Evaluation of surface runoff quality, like the evaluation of effluent quality, is based on the chemical composition of the discharge as well as the biological effects (toxicity). To perform these evaluations, surface runoff tests are performed on wet, anaerobic sediment and oxidized, aerobic sediment to generate representative samples of the runoff immediately after placement and later when the dredged material has dried out. The LAT-R program compares survival data for various aquatic organisms at several runoff dilutions and computes the LC50 for the runoff under both wet and dried conditions. Using the LC50 and a mixing zone model, the toxicity of the discharge can be evaluated for compliance with water quality regulations.

F.7.12.2 Major Capability. LAT-R statistically analyzes the survival data from a suite of water column bioassay tests for acute toxicity in accordance with the guidance in the Inland Testing Manual (USEPA/USACE 1994).

F.7.12.3 Current Version: 1.00 updated February 1997.



F.7.12.4 Points of Contact: Dr. Dennis L. Brandon, CEERD-EP-R, (601) 634-2807; Dr. Paul R. Schroeder, CEERD-EP-E, (601) 634-3709.

F.7.13 Combined (RUNQUAL and LAT-R) Runoff Pathway Evaluation Module (RUNOFF) application (Windows).

F.7.13.1 Description. The RUNOFF application has all the basic components of both the RUNQUAL and LAT-R modules already described and was written for Windows operating systems.

F.7.13.2 Major Capabilities. RUNOFF has the following capabilities:

a. Computes predicted dissolved and total contaminant concentrations in the surface runoff discharged from a confined placement site using surface runoff quality test data.

b. Compares predicted surface runoff concentrations with specified water quality standards.

c. Computes required dilutions of surface runoff discharge to meet specified water quality standards, considering background concentrations in the receiving water.

d. Statistically analyzes the survival data from a suite of water column bioassay tests for acute toxicity in accordance with the guidance in the Inland Testing Manual (USEPA/USACE 1994).

F.7.13.3 Current Version: 1.00 updated January 2000.

F.7.13.4 Points of Contact: Dr. Dennis L. Brandon, CEERD-EP-R, (601) 634-2807; Dr. Paul R. Schroeder, CEERD-EP-E, (601) 634-3709

F.7.14 Computation of Mixing Zone Size or Dilution for Continuous Discharges Fate (CDFATE) application (DOS and Windows).

F.7.14.1 Description. This application predicts (1) mixing zone requirements to meet water quality standards and (2) compliance with water quality standards given a mixing zone. It is applicable for continuous discharges from dredged material placement operations. The operations considered by the module include discharge of effluents or runoff from upland confined placement from a weir, pipe, or stream; leakage through porous dikes; overflows from hopper dredges or barges; and discharges of dredged material from a pipeline.

F.7.14.2 Major Capabilities. CDFATE has the following capabilities:

a. Accommodates 6 types of surface or near-surface discharges.

b. Predicts mixing zone requirements to meet water quality standards.

c. Predicts compliance with water quality standards given a mixing zone.

F.7.14.3 Current Version: 1.0 updated November 1994 (Windows conversion September 2001).

F.7.14.4 Point of Contact: Dr. Paul R. Schroeder, CEERD-EP-E, (601) 634-3709.

F.7.15 Short-Term Fate of Dredged Material Disposal in Open Water (STFATE) application (DOS and Windows).

F.7.15.1 Description. This application mathematically models the physical processes determining the short-term fate of dredged material disposed at open-water sites (that is, within the first few hours after disposal). It was developed from the DIFID (DISposal From an Instantaneous Dump) model. In STFATE, the behavior of the material is assumed to be separated into three phases: convective descent, dynamic collapse, and passive transport-dispersion. The model estimates receiving water concentrations of suspended sediment and dissolved constituent and the initial deposition of material on the bottom. Estimates of water column concentrations are often needed to determine mixing zones whereas the initial deposition pattern of material on the bottom is required in long-term sediment transport that assesses the potential for erosion, transport, and subsequent redeposition of the material. This model can also serve as a valuable aid in field monitoring programs, and it can be used in evaluating water column effects of open-water disposal of dredged material in accordance with Section 103 of the Marine Protection, Research, and Sanctuary Act and Section 404(b)(1) of the Clean Water Act.

F.7.15.2 Major Capabilities. STFATE has the following capabilities:

- a. Estimates receiving water concentrations of suspended solids, dredged material liquid and suspended phases, and dissolved contaminants as a function of time and location and compares contaminant concentrations with water quality standards.
- b. Estimates the percentage of suspended solids deposited on the bottom as a function of time and location and the thickness of deposition.
- c. Estimates mixing zone requirements to meet water quality standards.

F.7.15.3 Current Version: 5.01 May 2000 (Windows Version December 2004)

F.7.15.4 Points of Contact: Dr. Paul R. Schroeder, CEERD-EP-E, (601) 634-3709; Jarrell Smith, CEERD-HC-CT, (601) 634-4310

F.7.16 Multiple Disposal Fate of Dredged Material in Open Water (MDFATE) application (DOS).

F.7.16.1 Description. MDFATE, a multiple dredged material placement model, predicts post-disposal bathymetry for ocean dredged material disposal sites. This PC-driven numerical simulation incorporates existing numerical models to simulate the overall (short- and long-term) behavior of dredged material placed within an open-water disposal site. The MDFATE model spatially accounts for bathymetric changes within an offshore disposal area and can be used to

assist with selection of the most efficient layout for a proposed disposal site or provide guidance for optimizing dredged material placement operations.

F.7.16.2 Major Capabilities. MDFATE has the following capabilities:

- a. Simulates multiple placement events at one site to predict mound buildup.
- b. Simulates the effects of local currents and waves on the sediment as it falls through the water column and settles on the mound.
- c. Accounts for effects of grain size and bulk density on settling, changes in volume during deposition, and various dredging and placement methods.

F.7.16.3 Current Version: 1.1 updated August 1996.

F.7.16.4 Point of Contact: Jarrell Smith, CEERD-HC-CT, (601) 634-4310.

F.7.17 Sediment Resuspension and Contaminant Release by Dredge (DREDGE) application (Windows).

F.7.17.1 Description. This application assists users in making a priori assessments of environmental impacts from proposed dredging operations. DREDGE estimates the mass rate at which bottom sediments become suspended into the water column as the result of hydraulic and mechanical dredging operations and the resulting suspended sediment concentrations. These are combined with information about site conditions to simulate the size and extent of the resulting suspended sediment plume. DREDGE also estimates particulate and dissolved contaminant concentrations in the water column based upon sediment contaminant concentrations and equilibrium partitioning theory.

F.7.17.2 Major Capabilities. DREDGE has the following capabilities:

- a. Provides rapid calculation of dredge plume concentrations resulting from mechanical and hydraulic dredging operations.
- b. Contains an extensive toxic organic chemical and heavy metal database system plus default Kow (octanol-water partitioning coefficient) values for over 200 chemicals.
- c. Has source strength models for mechanical and hydraulic dredging operations.
- d. Provides a 2-D analytical transport model to predict the fate of resuspended sediments without particle flocculation in a water column.

F.7.17.3 Current Version: 1.1 updated October 1997.

F.7.17.4 Points of Contact: Dr. Paul R. Schroeder, CEERD-EP-E, (601) 634-3709; Thomas D. Borrowman, CEERD-EP-E, (601) 634-4048.

F.7.18 Evaluation of Contaminant Release from Bottom Sediments (RECOVERY) application (DOS).

F.7.18.1 Description. This application is a screening-level model to assess the long-term impact of contaminated bottom sediments on surface waters. The model couples contaminant interaction between the water column and the bottom sediment, as well as between the contaminated and clean bottom sediments. The analysis is intended primarily for organic contaminants with the assumption that the water column is well mixed. Processes incorporated in the model are sorption, decay, volatilization, burial, resuspension, settling, bioturbation, and pore-water diffusion. The solution couples contaminant mass balance in the water column and in the mixed sediment layer along with diffusion and bioturbation in the deep sediment layers.

F.7.18.2 Major Capabilities. RECOVERY has the following capabilities:

- a. Allows for a rapid analysis of recovery scenarios for contaminated sediments and cap evaluations.
- b. Simulates behavior of organics in a real system with a limited amount of data.
- c. Predicts desorption of contaminants from sediments.

F.7.18.3 Current Version: 3.00 updated December 1999.

F.7.18.4 Points of Contact: Dr. Carlos E. Ruiz, CEERD-EP-W, (601) 634-3784; Dr. Paul R. Schroeder, CEERD-EP-E, (601) 634-3709.

APPENDIX G

Plans and Specifications for Settling Columns

G.1 Purpose. This appendix contains figures showing plans and specifications for settling columns.

G.2 Side-View Sedimentation Column Plan and Specifications. Figure G-1 presents a side view plan and specifications for a settling column.

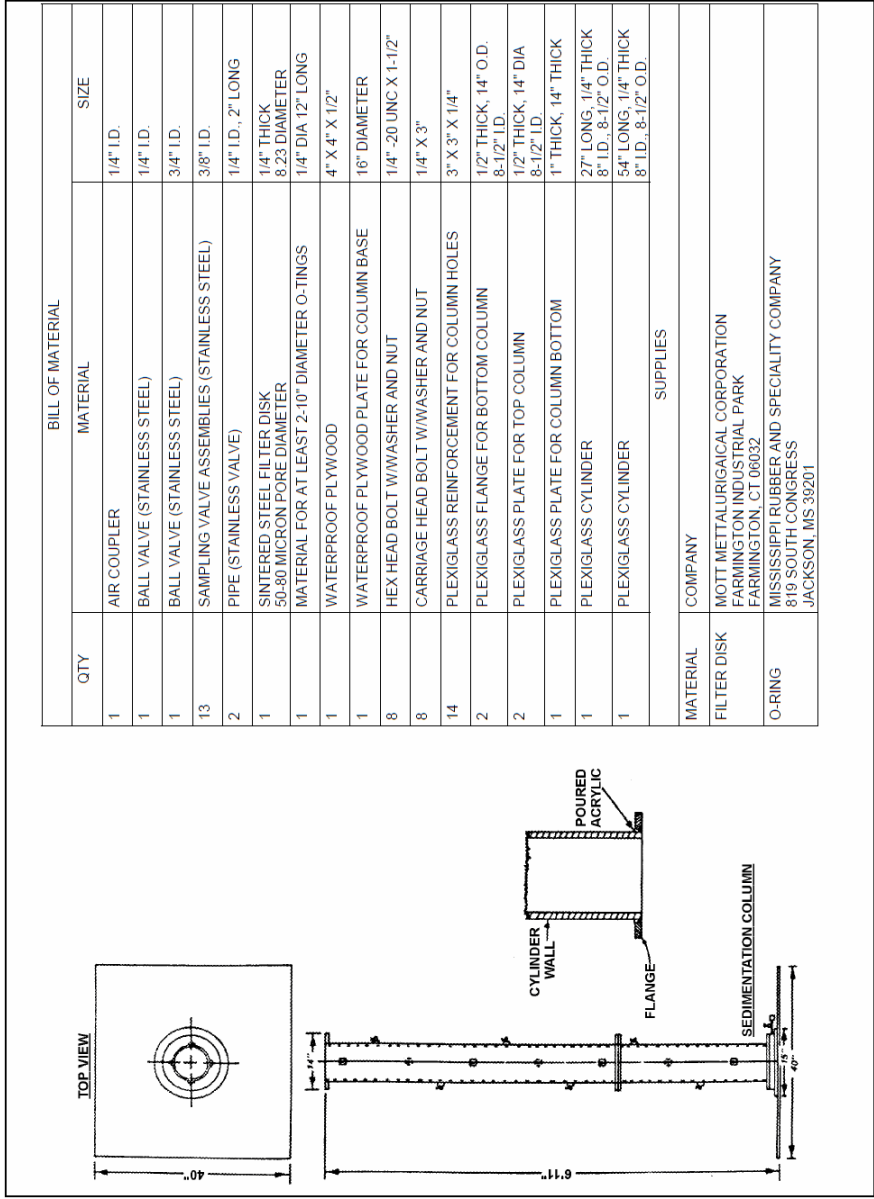

Figure G-1. Plan for Sedimentation Column and Specifications for Settling Column

G.3 Top and Bottom Sedimentation Column Plans. Figure G-2 presents plans for top and bottom columns.

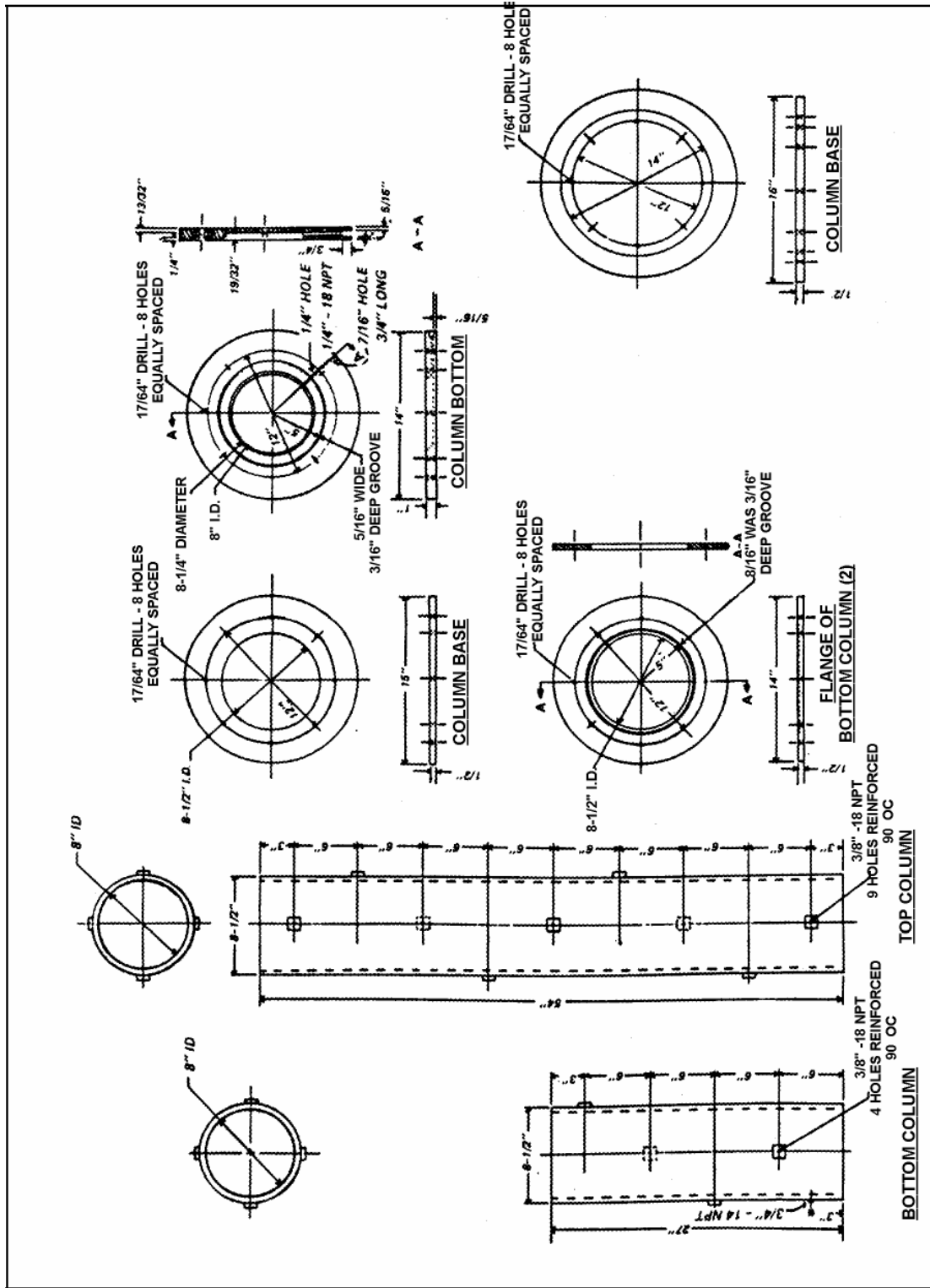

Figure G-2. Plans for Top and Bottom Columns

## APPENDIX H

### Column Settling Test Procedures

H.1 General. A Confined Disposal Facility (CDF) must be designed and operated to provide adequate initial storage volume and surface area to hold the dredged material solids during an active filling operation and, if hydraulically filled, to retain suspended solids such that clarified water is discharged. The required initial storage capacity and surface area are governed by zone, flocculant, and compression-settling processes that occur in a CDF during placement of fine-grained dredged material. Procedures to evaluate the required surface area and volume during active filling operations, to estimate effluent suspended solids concentrations, and to design other features for CDFs are described in Chapter 4, “Confined (Diked) Placement” of this EM.

### H.2 Settling Processes.

H.2.1 Settling types. The settling process can be categorized according to four basic classifications:

- a. Discrete settling, where the particle maintains its individuality and does not change in size, shape, or density during the settling process.
- b. Flocculant settling, where particles agglomerate during the settling period with a change in physical properties and settling rate.
- c. Zone settling, where the flocculant suspension forms a lattice structure and settles as a mass (the high solids concentration partially blocks the release of water and hinders settling of neighboring particles), and a distinct interface between the slurry and the supernatant water is exhibited during the settling process.
- d. Compression settling, where settling occurs by compression of the lattice structure. All of the above sedimentation processes may occur simultaneously in a placement area, and any one may control the design of the placement area.

H.2.2 Governing factors. Discrete settling describes the sedimentation of coarse particles. The important factors governing the sedimentation of fine-grained dredged material are the initial concentration of the slurry, the salinity of the carrier water, and the flocculating properties of the solid particles. Because of the high influent solids concentration and the tendency of fine-grained particles to flocculate, either flocculant or zone settling behavior normally describes sedimentation in containment areas. Sedimentation of freshwater sediments at slurry concentrations of 100 g/L can generally be characterized by flocculant settling properties. As slurry concentrations or salinity is increased, the sedimentation process may be characterized by zone settling properties. Compression settling occurs in the lower layers of settled material for both the flocculant and zone settling cases. As more settled material accumulates, excess pore pressures develop in the lower layers, and further consolidation occurs as water is expelled and the excess pore pressures dissipate.

H.2.3 Zone versus flocculant settling as a function of salinity. The tendency of a fine-grained dredged material slurry to settle by zone or flocculant behavior in the initial stages of settling is strongly influenced by the presence of salt as a coagulant. If salinity is less than 1 ppt, indicative of freshwater conditions, flocculant processes normally describe the initial settling, and no clearly defined interface is seen. If salinity is greater than 1 ppt, indicative of brackish or saltwater conditions, zone settling processes normally describe the initial settling, and a clear interface between the clarified supernatant water and the more concentrated slurry is evident. For the zone settling case, some of the fine particles remain in the supernatant water as the interface falls. Flocculant processes, then, describe the settling of these fine particles from the supernatant.

### H.3 Testing Equipment and Procedures.

H.3.1 Test objective. The objective of running settling tests on sediments to be dredged is to define their settling behavior in a dredged material containment area. The tests provide numerical values for the design criteria that can be projected to the size and design of the containment area. Procedures for computer-assisted plotting and reduction of settling column data are available as discussed in Appendix F, "Automated Dredging and Disposal Alternatives Modeling System (ADDAMS)."

H.3.2 Settling column. The settling column shown in Figure H-1 should be used for dredged material settling tests. The column is constructed of 20 cm (8 in.) diameter Plexiglas tubing and can be sectioned for easier handling and cleaning. Ports are provided for extraction of samples at various depths during sampling. A bottom-mounted AirStone is also provided for agitation and mixing of slurries in the column by using compressed air. Shop drawings of the column with bills of material are shown in Appendix G, "Plans and Specifications for Settling Column."

H.3.3 Samples. Samples used to perform settling tests should consist of fine-grained (<No. 200 sieve) material. Any coarse-grained (>No. 200 sieve) material present in the sample would normally be hydraulically separated when the sample is mixed prior to sedimentation testing. A composite of several sediment samples may be used to perform the tests if this is thought to be more representative of the dredged material. Approximately 55 L (15 gal) of sediment is usually required for the tests. Water used to mix the slurries can be taken from the proposed dredging site or can be prepared by mixing tap water and salt to the known salinity of the dredging site water.

H.3.4 Pilot test. A pilot test conducted in a graduated cylinder (4 L is satisfactory) is a useful method for determining if flocculant or zone process will describe the initial settling. The pilot test should be run at a slurry concentration of approximately 150 g/L. If an interface forms within the first few hours of the test, the slurry mass is exhibiting zone settling, and the fall of the interface versus time should be recorded. The curve will appear as shown in Figure H-2. The break in the curve defines the concentration at which compression settling begins. Only lower concentrations should be used for the zone settling test in the 20 cm (8 in.) column. If no break in the curve is evident, the material has begun settling in the compression zone, and the pilot test should be repeated at a lower slurry concentration. It should be emphasized that use of a small cylinder as in the pilot test is not acceptable for use in design. Wall effects for columns of small



diameter affect zone settling velocities and data obtained using small diameter columns will not accurately reflect field behavior. If no interface is observed in the pilot test within the first few hours, the slurry mass is exhibiting flocculant settling. In this case, the pilot test should be continued until an interface is observed between the turbid water above and more concentrated settled solids below. The concentration of the settled solids (computed assuming zero concentration of solids above) is an indication of the concentration at which the material exhibits compression settling.

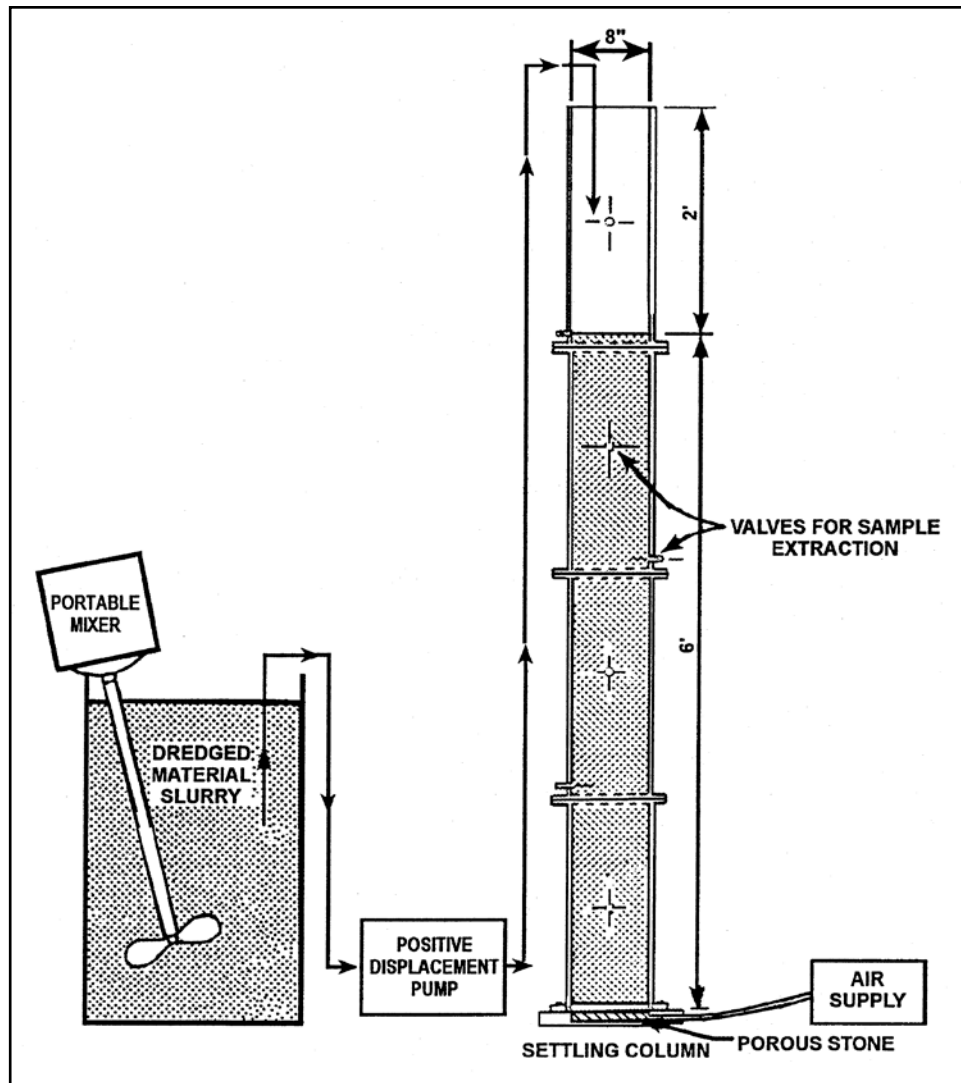

Figure H-1. Schematic of the Apparatus Used for Settling Tests

31 Jul 15

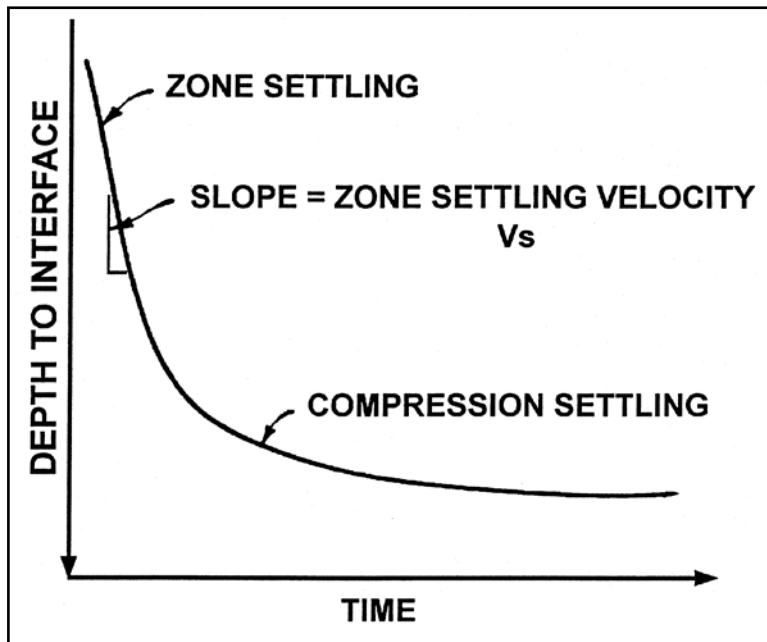

Figure H-2. Conceptual Plot of Interface Height Versus Time

H.3.5 Required number of column loadings for tests. Three types of settling tests in the 20 cm (8 in.) column may be needed to fully define the settling properties of the dredged material. However, in most cases the 20 cm (8 in.) settling column used for the settling tests needs to be loaded with slurry only once. A compression settling test is needed to define the volume that will be occupied in the placement area by a newly deposited dredged material layer at the end of the placement operation. A flocculant settling test for either the slurry mass or for the supernatant water above any interface is required to predict effluent suspended solids concentrations. A zone settling test is required to define the minimum surface area needed for effective zone settling. These tests should be conducted at a slurry concentration equal to the expected influent concentration; therefore, only one loading of the test column is required to collect data for all purposes.

#### H.4 Flocculant Settling Test.

H.4.1 The flocculant settling test consists of measuring the concentration of suspended solids at various depths and time intervals in a settling column. If an interface forms near the top of the settling column during the first day of the test, sedimentation of the material below the interface is described by zone settling. In that case, the flocculant test procedure should be continued only for that portion of the column above the interface.

H.4.2 Information required to design a containment area for the flocculant settling process can be obtained using the following procedure:

H.4.2.1 Use a settling column such as that shown in Figure H-1. The slurry depth used in the test column should approximate the effective settling depth of the proposed containment area. A

practical limit on depth of test is 1.8 m (6 ft). The column should be at least 20 cm (8 in.) in diameter with sample ports at 0.15 m (0.5 ft) intervals (minimum). The column should have provisions for slurry agitation with compressed air from the bottom to keep the slurry mixed during the column filling period.

H.4.2.2 Mix the sediment slurry to a suspended solids concentration  $C$  equal to the expected concentration of the dredged material influent  $C_i$ . The slurry should be mixed in a container with sufficient volume to fill the test column. Field studies indicate that for maintenance dredging of fine-grained material, the placement concentration average about 150 g/L. This concentration should be used in the test if better data are not available.

H.4.2.3 Pump or pour the slurry into the test column using compressed air or mechanical agitation to maintain a uniform concentration during the filling period.

H.4.2.4 When the slurry is completely mixed in the column, cut off the compressed air or mechanical agitation, immediately draw off samples at each sample port, and then determine the suspended solids concentration of each sample. Use the average of these values as the initial slurry concentration at the start of the test. The test is considered initiated when the first samples are drawn.

H.4.2.5 If an interface has not formed on the first day, flocculant settling is occurring in the entire slurry mass. Allow the slurry to settle and withdraw samples from each sampling port at regular time intervals to determine the suspended solids concentrations. Substantial reductions of suspended solids will occur during the early part of the test, but reductions will lessen at longer retention times. Therefore, the intervals can be extended as the test progresses. Recommended sampling intervals are 1, 2, 4, 6, 12, 24, 48, 96 hours, and so on, until the end of the test. As a rule, a 50 mL (1.7 oz) sample should be taken from each port. Continue the test until an interface can be seen near the bottom of the column and the suspended solids concentration in the fluid above the interface is 1 g/L. Test data are tabulated and used to plot a concentration profile diagram, as shown in Figure H-3. Examples are shown in Appendix I, "Design Calculations for Retention of Solids and Initial Storage."

H.4.2.6 If an interface forms the first day, zone settling is occurring in the slurry below the interface, and flocculant settling is occurring in the supernatant water. For this case, samples should be extracted from all side ports above the falling interface. The first of these samples should be extracted immediately after the interface has fallen sufficiently below the uppermost port to allow extraction. This sample can usually be extracted within a few hours after the beginning of the test, depending on the initial slurry concentration and the spacing of ports. Record the time of extraction and the port height for each port sample taken. As the interface continues to fall, extract samples from all ports above the interface at regular time intervals. As an alternative, samples can be taken above the interface at the desired depths using a pipette or syringe and tubing. As before, a suggested sequence of sampling intervals would be 1, 2, 4, 6, 12, 24, 48, 96 hours, and so on. The samples should be taken continuously until the suspended solids concentration of the extracted samples shows no decrease. For this case, the suspended solids in the samples should be less than 1 g/L, and filtration is required to determine the concentrations.

31 Jul 15

The data should be expressed in milligrams per liter for these samples. Tabulate the data and plot a concentration profile diagram, as shown in Figure H-3. In reducing the data for this case, the concentration of the first port sample taken above the falling interface is considered the initial concentration  $C_o$ . Examples are shown in Appendix I, "Design Calculations for Retention of Solids and Initial Storage."

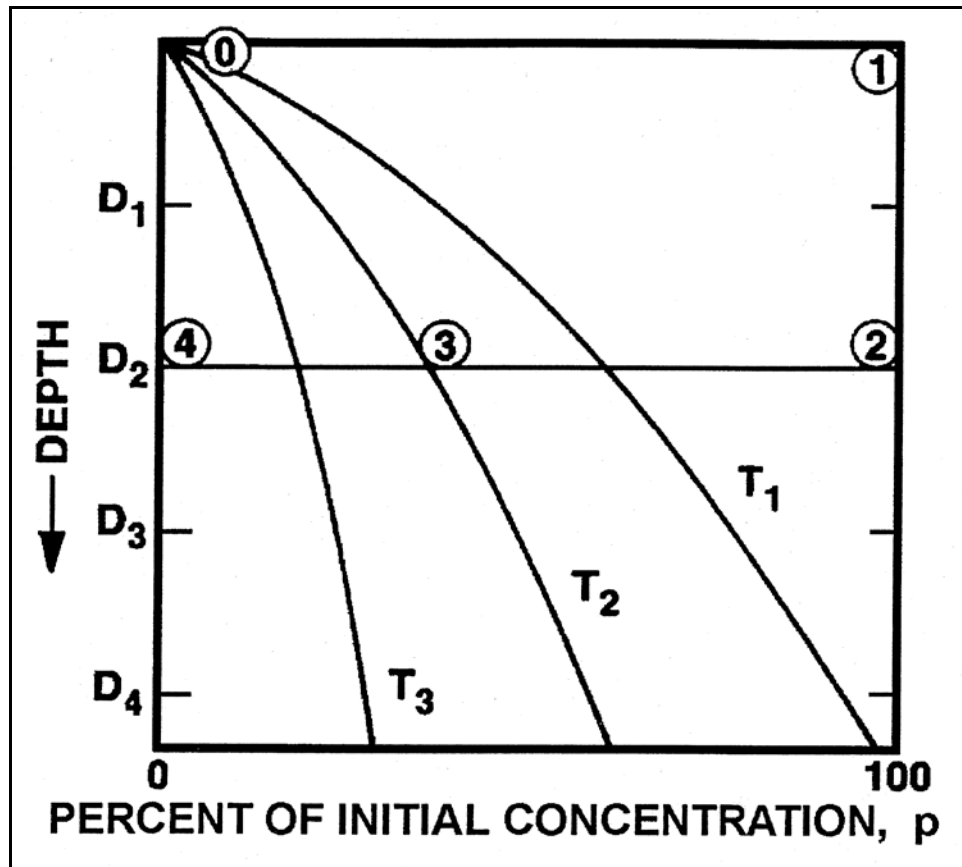

Figure H-3. Conceptual Concentration Profile Diagram

### H.5 Zone Settling Test.

H.5.1 The zone settling test consists of placing a slurry in a sedimentation column and then reading and recording the fall of the liquid-solids interface with time. These data are plotted as depth to interface versus time. The slope of the constant velocity settling zone of the curve is the zone settling velocity, which is a function of the initial test slurry concentration. This test is required if the material exhibits an interface within the first day. The test should be run at the expected influent slurry concentration, or the highest expected to persist for several hours if a range is expected.

H.5.2 Information required to design a containment area for the zone settling process can be obtained by using the following procedure:

- a. Use a settling column, such as that shown in Figure H-1. It is important that the column diameter be sufficient to reduce the “wall effect” and that the test be performed with a test slurry depth near that expected in the field. Therefore, a 1 L graduated cylinder should never be used to perform a zone settling test for sediment slurries representing dredging placement activities.
- b. Mix the slurry to the desired concentration and then either pump or pour it into the test column. Air may not be necessary to keep the slurry mixed if the filling time is less than 1 minute.
- c. Record the depth to the solid-liquid interface as a function of time. Readings must be taken at regular intervals to gain data for plotting the curve of depth to interface versus time, as shown in Figure H-2. It is important that enough readings be taken to clearly define this curve.
- d. Continue the readings until sufficient data are available to define the maximum point of curvature of the depth to interface versus time plot. The test may require from 8 to 48 hours to complete.
- e. Calculate the zone settling velocity ( $v_s$ ) as the slope of the constant velocity settling zone, as shown in Figure H-2 (straight-line portion of curve). The velocity should be in feet per hour.

## H.6 Compression Settling Test.

H.6.1 A compression settling test must be run to obtain data for estimating the volume required for initial storage of the dredged material. For slurries exhibiting zone settling, the compression settling data can be obtained from the zone settling test with interface height versus time recorded. The only difference is that the test is continued for a period of 15 days, so that a relationship of log of concentration versus log of time in the compression settling range, as shown in Figure H-4, can be obtained. For slurries exhibiting flocculant settling behavior, the test used to obtain flocculant settling data can be used for the compression settling test if an interface is formed after the first few days of the test. If an interface is not formed, an additional test is required, with the slurry concentration for the test sufficiently high to initially induce compression settling. This concentration can be determined by the pilot test.

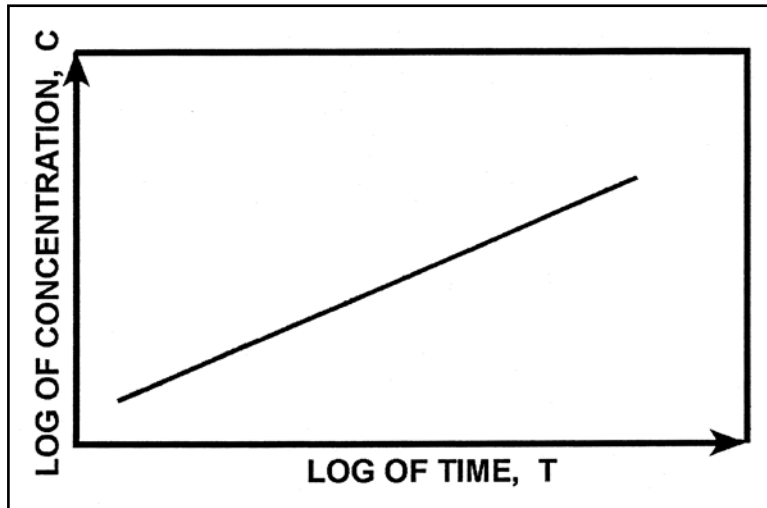

Figure H-4. Conceptual Time Versus Concentration Plot

H.6.2 Information required to design a containment area for the compression settling process can be obtained using the following procedure:

- a. Tabulate the interface height  $H_t$  for various times of observation during the 15-day test period.
- b. Calculate concentrations for various interface heights as follows:

$$C = \frac{C_o H_i}{H_t} \quad (\text{I-1})$$

where

$C$  = slurry concentration at time  $t$ , grams per liter

$C_o$  = initial slurry concentration, grams per liter

$H_i$  = initial slurry height, ft

$H_t$  = height of interface at time  $t$ , ft

Neglect solids in the water above the interface to simplify calculations.

- c. Plot concentration versus time on log-log paper, as shown in Figure H-4.
- d. Draw a straight line through the data points.

## APPENDIX I

## Design Calculations for Retention of Solids and Initial Storage

I.1 **General.** This appendix presents the procedures for designing a Confined Disposal Facility (CDF) for suspended solids retention and initial storage volume. Data from column settling tests described in Appendix H, “Column Settling Test Procedures,” are used in the design. The generalized flowchart shown in Figure I-1 illustrates the design procedures presented in the following paragraphs. These steps were adapted from procedures used in water and wastewater treatment and are based on field and laboratory investigations of sediments and dredged material at active dredged material containment areas. The procedures in this chapter are presented in the manner required to calculate the minimum required placement area geometry for a given inflow rate (dredge size) and dredged volume. The same procedures can be used in reverse fashion to calculate a maximum flow rate (dredge size) allowable for a given placement area geometry. Numerical examples of both approaches are presented in this appendix. Procedures for computer-assisted design for sedimentation and initial storage are also available as discussed in Appendix F, “Automated Dredging and Disposal Alternatives Modeling System (ADDAMS).”

I.2 Volume for Initial Storage.

I.2.1 **General.** Containment areas must be designed to meet volume requirements for a particular placement activity. The total volume required in a containment area includes volume for storage of dredged material, volume for sedimentation (ponding depths), and freeboard volume (volume above water surface). Volume required for storage of the coarse-grained (>No. 200 sieve) material must be determined separately since this material behaves independently of the fine-grained (<No. 200 sieve) material.

I.2.2 **Calculation of design concentration.** The design concentration  $C_d$  is defined as the average concentration of the dredged material in the containment area at the end of the placement activity and is estimated from the compression (15-day) settling test described in Appendix H, “Column Settling Test Procedures.” This design parameter is required both for estimating initial storage requirements and for determining minimum required surface areas for effective zone settling. The following steps can be used to estimate  $C_d$  from the compression settling test.

a. Step 1—Estimate the time of dredging by dividing the dredge production rate into the volume of sediment to be dredged. Use Figure I-2 for estimating the dredge production rate if no specific data are available from past dredging activities. (Note that curves in Figure I-2 were developed for sand.) The total time required for dredging should allow for anticipated downtime.

b. Step 2—Enter the concentration versus time plot, as shown in Figure I-3, and determine the concentration at a time  $t$  equal to one-half the time required for the placement activity determined in step 1.

The value computed in Step 2 is the design solids concentration  $C_d$ . Examples are shown in Section I.6.

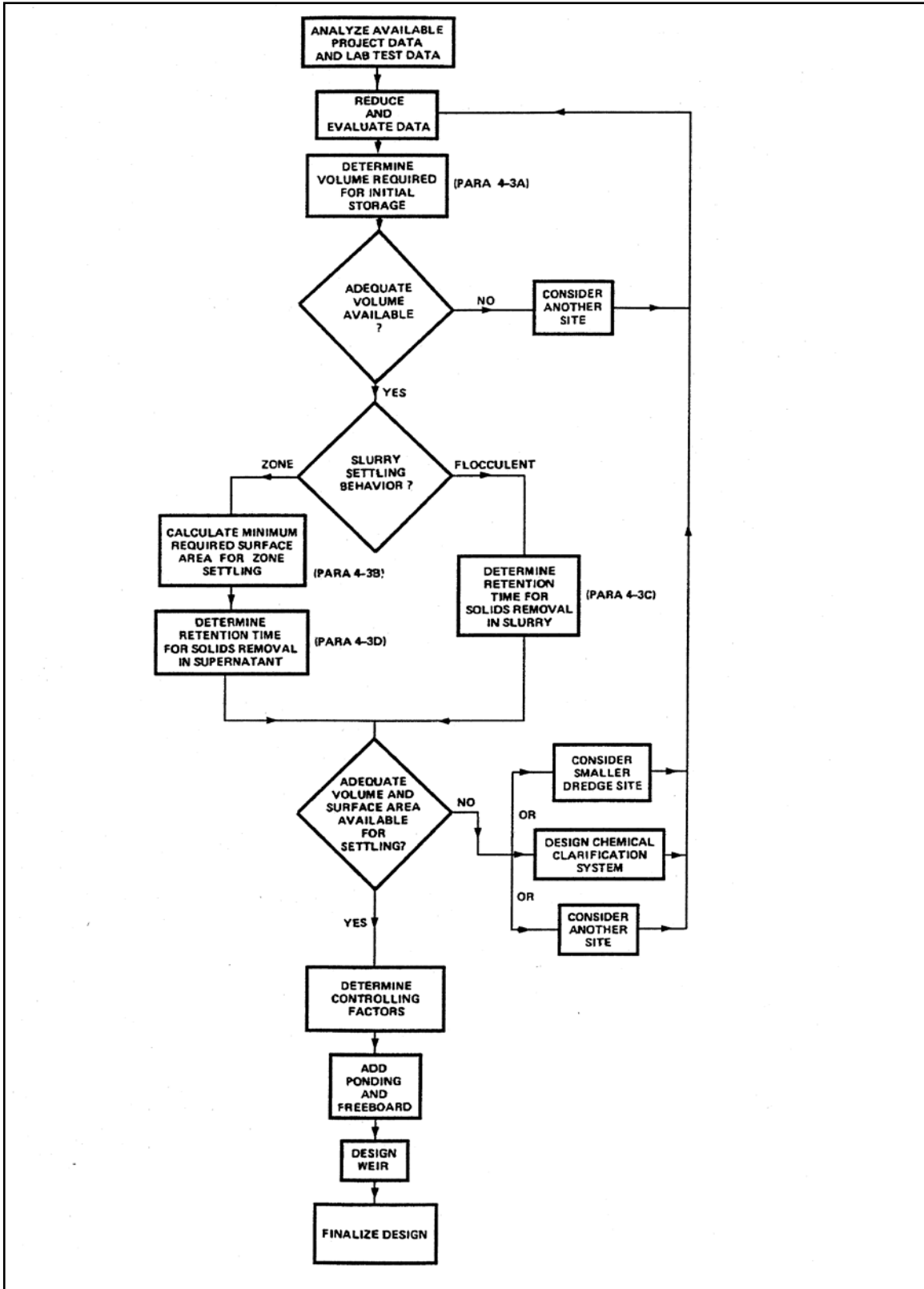

Figure I-1. Flowchart of the Design Procedure for Settling and Initial Storage



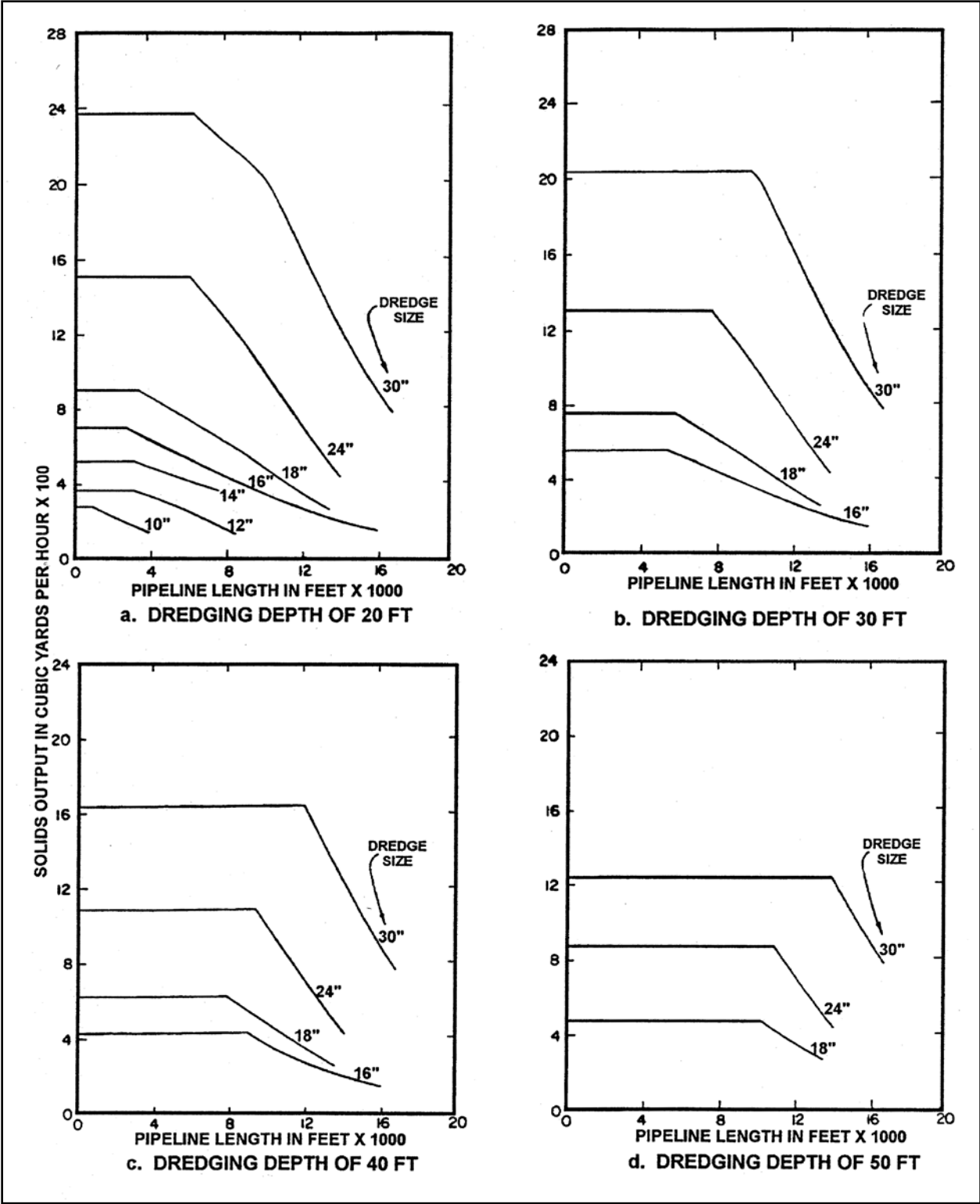

Figure I-2. Relationships Among Solids Output, Dredge Size, and Pipeline Length for Various Dredging Depths

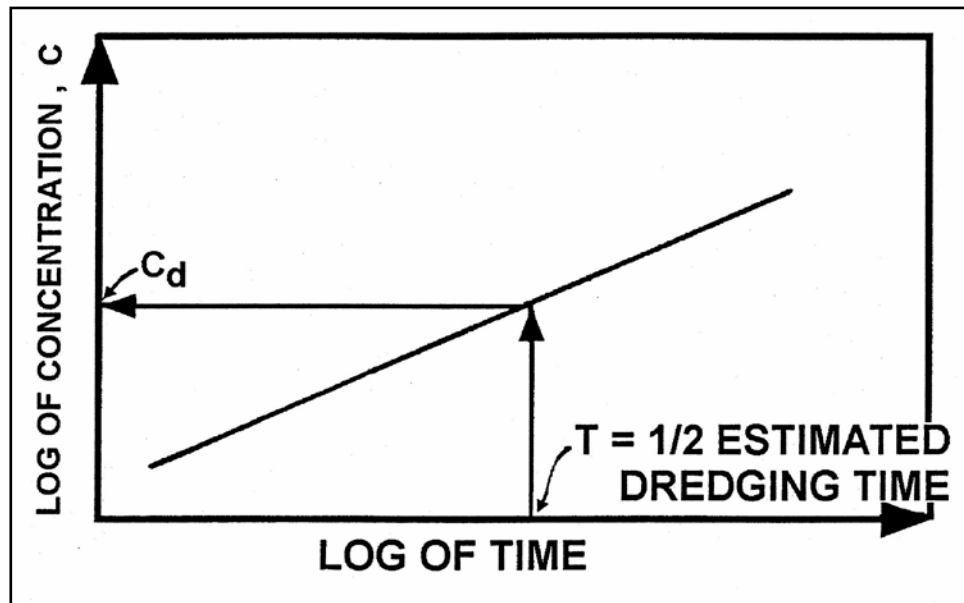

Figure I-3. Conceptual Time Versus Concentration Plot

I.2.3 Volume estimation. The volume computed in the following steps is the volume occupied by dredged material in the containment area immediately after the completion of a particular placement activity. This value is critical in determining the dike height requirements for the containment area. The volume is not an estimate of the long-term needs for multiple-placement activities. Estimates for long-term storage capacity can be made using the procedures outlined in Section 4.5. The design for initial storage may be a controlling factor regardless of the settling behavior exhibited by the material. If the material initially exhibits compression settling at the expected inflow concentration, the design for initial storage is the only consideration (this is expected to be an exceptional case).

a. Using the design concentration  $C_d$  determined in Figure I-3, compute the average void ratio of the fine-grained dredged material in the containment area at the completion of the dredging operation. Use the following equation to determine the void ratio:

$$e_o = \frac{G_s \gamma_w}{C_d} - 1 \quad (\text{I-1})$$

where

$e_o$  = average void ratio of the dredged material in the containment area at the completion of the dredging operation

$\gamma_w$  = density of water, g/L (normally 1,000 g/L)

b. Compute the volume of the fine-grained channel sediments after placement in the containment area:

$$V_f = V_i \left\{ \left( \frac{e_o - e_i}{1 + e_i} \right) + 1 \right\} \quad (\text{I-2})$$

where

$V_f$  = volume of the fine-grained dredged material after placement in the containment area, ft<sup>3</sup>

$V_i$  = volume of the fine-grained channel sediments, ft<sup>3</sup>

$e_i$  = average void ratio of the in situ channel sediments

c. Compute the volume required to store the dredged material in the containment area:

$$V = V_f + V_{sd} \quad (\text{I-3})$$

where

$V$  = total volume of the dredged material in the containment area at the end of the dredging operation, ft<sup>3</sup>

$V_{sd}$  = volume of sand (use 1:1 ratio), ft<sup>3</sup>

d. If there are limitations on the surface area available for placement or if an existing placement site is being evaluated, check whether the site conditions will allow for initial storage of the volume to be dredged. First, determine the maximum height at which the material can be placed  $H_{dm(\max)}$ , using the following equation:

$$H_{dm(\max)} = H_{dk(\max)} - H_{pd} - H_{fb} \quad (\text{I-4})$$

where

$H_{dm(\max)}$  = maximum height at which the material can be placed

$H_{dk(\max)}$  = maximum allowable dike height due to foundation conditions, ft

$H_{pd}$  = ponding depth, ft

$H_{fb}$  = freeboard (minimum of 2 ft can be assumed), ft

31 Jul 15

- e. Compute the minimum surface area that can be used to store the material:

$$A_{ds} = \frac{V}{H_{dm(\max)} (43,560)} \quad (\text{I-5})$$

where

$A_{ds}$  = design surface area for storage, acres

If  $A_{ds}$  is less than the available surface area, then adequate volumetric storage is available at the site.

### I.3 Minimum Surface Area for Effective Zone Settling.

I.3.1 General. If the sediment slurry exhibited zone settling behavior at the expected inflow concentration, the zone settling test results are used to calculate a minimum required ponded surface area in the containment for effective zone settling to occur. The method is generally applicable to dredged material from a saltwater environment, but it can also be used for freshwater dredged material if the laboratory settling tests indicate that zone settling describes the initial settling process. Additional calculations using flocculant settling data for the solids remaining in the ponded supernatant water are required for designing the containment area to meet a specific effluent quality standard for suspended solids.

I.3.2 Computation of area required for zone settling. The minimum surface area determined according to the following steps should provide removal of fine-grained sediments so that suspended solids levels in the effluent do not exceed several hundred milligrams per liter. The area is required for the zone settling process to remove suspended solids from the surface layers at the rate sufficient to form and maintain a clarified supernatant that can be discharged.

- a. Determine the zone settling velocity  $V_s$  at the influent suspended solids concentration  $C_i$ , as described in Appendix H, "Column Settling Test Procedures."

- b. Compute area requirements as

$$A_z = \frac{Q_i (3,600)}{V_s} \quad (\text{I-6})$$

where

$A_z$  = containment surface area requirement for zone settling,  $\text{ft}^2$

$Q_i$  = influent flowrate,  $\text{ft}^3/\text{sec}$

3,600 = conversion factor hours to seconds

$V_s$  = zone settling velocity at influent solids concentration  $C_i$ ,  $\text{ft}/\text{hr}$

c. Multiply the area by a hydraulic efficiency correction factor *HECF* to compensate for containment area inefficiencies:

$$A_{dz} = \frac{(HECF)A_z}{43,560} \quad (I-7)$$

where

$A_{dz}$  = design basin surface area for effective zone settling, acres

*HECF* = hydraulic efficiency correction factor (determined as described in Section I.5)

$A_z$  = area determined from Equation I-6, ft<sup>2</sup>

### I.3.3 Calculation of required retention for flocculant settling.

I.3.3.1 Sediments dredged from a freshwater environment normally exhibit flocculant settling properties. However, in some cases, the concentration of dredged material slurry is sufficiently high that zone settling will occur. The method of settling can be determined from the laboratory tests.

I.3.3.2 Sediments in a dredged material containment area are composed of a broad range of particle flocculant sizes and surface characteristics. In the containment area, larger particle flocculants settle at faster rates, thus overtaking finer flocculants in their descent. This contact increases the flocculant sizes and enhances settling rates. The greater the ponding depth in the containment area, the greater is the opportunity for contact among sediments and flocculants. Therefore, flocculant settling of dredged sediments is dependent on the ponding depth as well as the properties of the particles. For this reason, it is important that settling tests be performed with column heights corresponding to ponding depths expected under field conditions.

I.3.3.3 The concentration of suspended solids in the effluent depends on the total depth at which fluid is withdrawn at the weir, which is related to the hydraulic characteristics of the weir structure. The depth of withdrawal is equivalent to the depth of ponded water for weir configuration and the flow rates that are normally encountered in containment areas. For this reason, the term “ponding depth” is used interchangeably with “withdrawal zone” in this manual in the context of effluent quality evaluations.

I.3.3.4 Evaluation of the sedimentation characteristics of a sediment slurry exhibiting flocculant settling is accomplished, as discussed in Appendix H, “Column Settling Test Procedures.” The design steps to determine the required retention time for a desired effluent quality are as follows:

31 Jul 15

a. Calculate the removal percentage at the selected minimum average ponding depth  $H_{pd}$  for various times using the concentration profile plot as shown in Figure I-4. As an example, the removal percentage for  $H_{pd}$  = depth  $d_2$  and time  $t_2$  is computed as follows:

$$R = \frac{\text{Area right of profile}}{\text{Area Total}} (100) = \frac{\text{Area } 0, 1, 2, 3, 0^*}{\text{Area}} (100) \quad (\text{I-8})$$

where  $R$  is the removal percentage. Determine these areas by either planimetering the plot or by direct graphical measurements and calculations. This approach is used to calculate removal percentages for the selected ponding depth as a function of time.

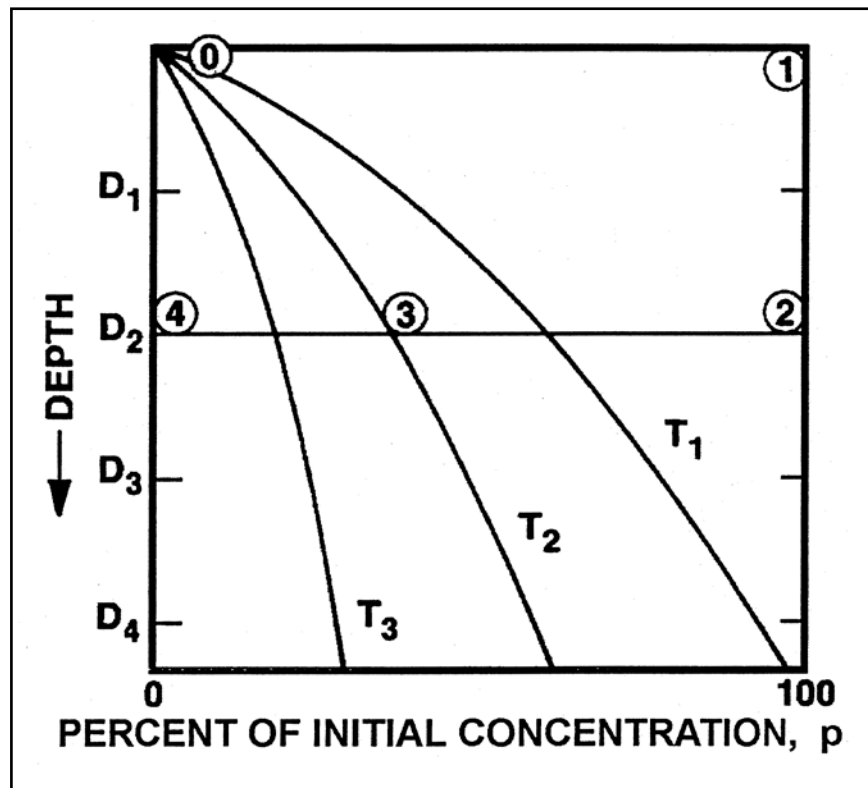

Figure I-4. Conceptual Concentration Profile Diagram

b. Plot the solids removal percentages versus time, as shown in Figure I-5.

c. Mean detention times can be selected from Figure I-5 for various solids removal percentages. Select the residence time  $T_d$  that gives the desired removal percentage.

d. Multiply the required mean residence time  $T_d$  by an appropriate hydraulic efficiency correction factor  $HECF$  to compensate for the fact that containment areas, because of inefficiencies, have field mean detention times less than theoretical (volumetric) detention times. The  $HECF$  is determined as described in Section I.5. The basin volumetric or theoretical residence time is estimated as follows:

$$T = HECF(T_d) \quad (I-9)$$

where  $T$  is the volumetric or theoretical residence time and  $T_d$  is selected from Figure I-5.

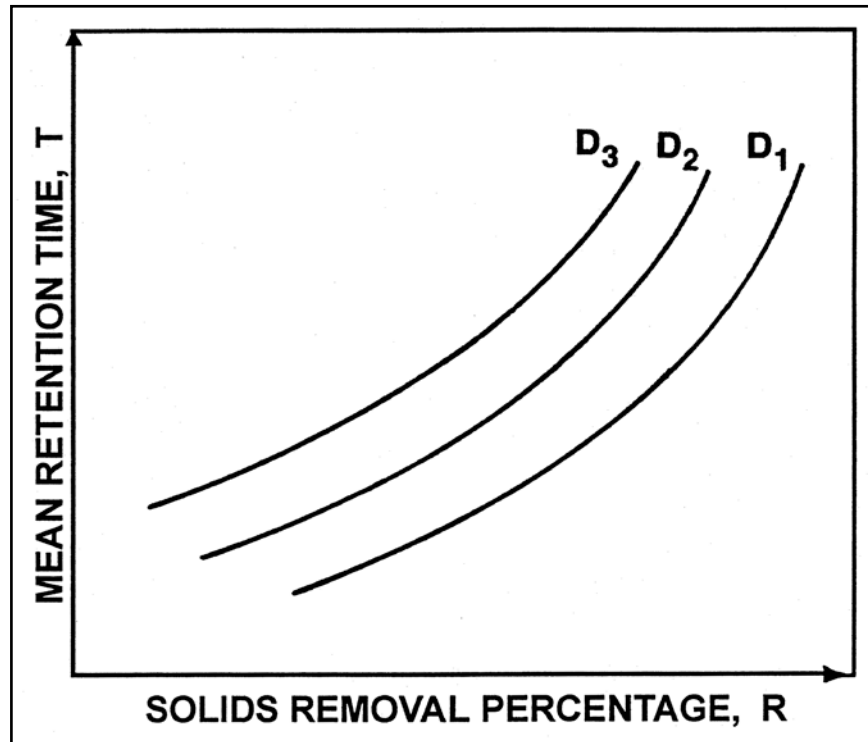

Figure I-5. Conceptual Plot of Solids Removal Versus Time for Slurries Exhibiting Flocculant Settling

e. Note that for the case of flocculant settling of the entire slurry mass, the solids are removed by gravity sedimentation to a level of 1-2 g/L. For this case, the selection of a required residence time for a percentage removal is more convenient. For the case of flocculant settling in the supernatant water, where the slurry mass is undergoing zone settling, selection of a required residence time for an effluent suspended solids standard is more appropriate. Examples are shown in Section I.6.

#### I.4 Required Retention Time of Suspended Solids.

I.4.1 Data analyses. For slurries exhibiting zone settling, flocculant settling behavior describes the process occurring in the supernatant water above the interface. Therefore, a

31 Jul 15

flocculant data analysis procedure as outlined in the following paragraphs is required. The steps in the data analysis are as follows:

a. Use the concentration profile diagram, as shown in Figure I-4, to graphically determine percentages removed,  $R$ , for the various time intervals and for the minimum ponding depth. This is done by graphically determining the area to the right of each concentration profile and its ratio to the total area above the depth, as described for the case of flocculant settling above.

b. Compute the percentages remaining as follows:

$$P = 100 - R \quad (\text{I-10})$$

c. Compute values for the average suspended solids concentration in the supernatant at each time of extraction as follows:

$$C_t = P_t C_o \quad (\text{I-11})$$

where

$C_t$  = suspended solids concentration at time  $t$ , mg/L

$P_t$  = percentage remaining at time  $t$

$C_o$  = initial concentration in the supernatant, mg/L

d. Tabulate the data and plot a relationship for suspended solids concentration versus time using the value for each time of extraction, as shown in Figure I-6. An exponential curve fitted through the data points is recommended.

I.4.2 Determination of retention time to meet an effluent suspended solids concentration. The relationship of supernatant suspended solids versus time developed from the column settling test is based on quiescent settling conditions found in the laboratory. The anticipated retention time in an existing placement area under consideration can be used to determine a predicted suspended solids concentration from the relationship. This predicted value can be considered a minimum value capable of being achieved in the field, assuming little or no resuspension of settled material. The relationship in Figure I-6 can also be used to determine the required retention time to meet a standard for effluent suspended solids. For dredged material slurries exhibiting flocculant settling behavior, the concentration of particles in the ponded water is 1 g/L or higher. The resuspension resulting from normal wind conditions does not significantly increase this concentration; therefore, an adjustment for resuspension is not required for the flocculant settling case. However, an adjustment for anticipated resuspension is appropriate for dredged material exhibiting zone settling. The minimum expected value and the value adjusted for resuspension would provide a range of anticipated suspended solids concentrations in the effluent. The following procedure should be used:



a. A standard for effluent suspended solids  $C_{eff}$  must be met, considering anticipated resuspension under field conditions. Calculate a corresponding maximum concentration under quiescent laboratory conditions as follows:

$$C_{col} = \frac{C_{eff}}{RF} \quad (I-12)$$

where

$C_{col}$  = maximum suspended solids concentration of effluent as estimated from column settling tests, milligrams suspended solids per liter of water

$C_{eff}$  = suspended solids concentration of effluent considering anticipated resuspension, milligrams suspended solids per liter of water

$RF$  = resuspension factor selected from Table I-1

Table I-1 summarizes recommended resuspension factors based on comparisons of suspended solids concentrations as predicted from column settling tests and field data from a number of sites with varying site conditions.

Table I-1. Recommended Resuspension Factors for the Zone Settling Case for Various Poned Areas and Depths

Anticipated Poned Area	Anticipated Average Poned Depth	
	Less than 2 ft	2 ft or Greater
Less than 100 acres	2.0	1.5
Greater than 100 acres	2.5	2.0

b. Using Figure I-6, determine the required minimum mean residence time corresponding to  $C_{col}$ .

c. As in the case for flocculant settling of the entire slurry mass, increase the mean residence time by an appropriate hydraulic efficiency correction factor  $HECF$  using Equation I-9. Then use the resulting minimum volumetric or theoretical residence time  $T$  to determine the required placement area geometry.

31 Jul 15

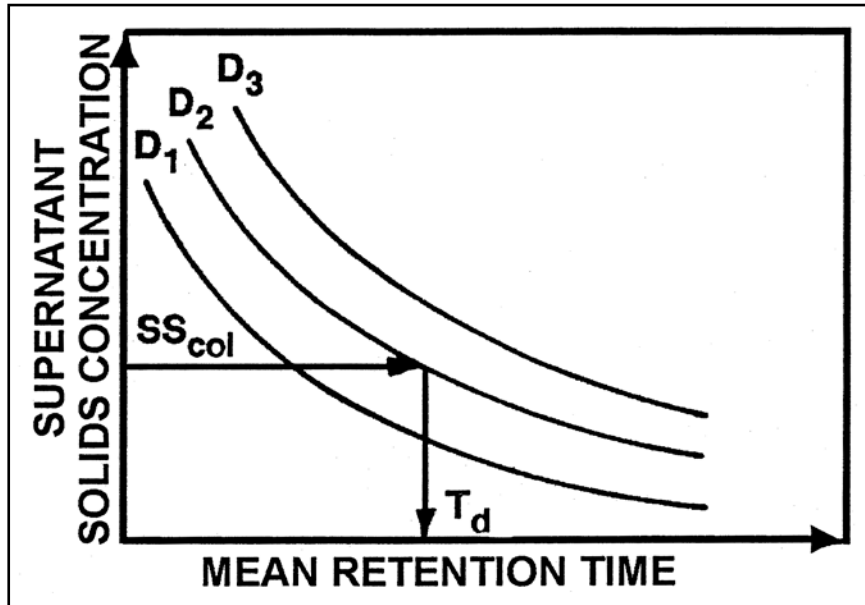

Figure I-6. Conceptual Plot of Supernatant Suspended Solids Concentration Versus Time from Column Settling Tests

I.4.3 Computation of design surface area for flocculant settling. Calculate the design surface area for flocculant settling as follows:

$$A_{df} = \frac{TQ_j}{H_{pd} (12.1)} \quad (\text{I-13})$$

where

$A_{df}$  = design surface area for flocculant settling, acres

$T$  = minimum mean residence time, hr

$Q_i$  = average inflow rate, ft<sup>3</sup>/sec

$H_{pd}$  = average ponding depth, ft

12.1 = conversion factor acre-ft/ft<sup>3</sup>/sec to hours

## I.5 Estimation of Hydraulic Efficiency Correction Factor.

I.5.1 Estimates of the field mean retention time for expected operational conditions are required for prediction of suspended solids concentrations in the effluent. These estimates must consider the hydraulic efficiency of the placement area, defined as the ratio of mean retention time to theoretical retention time. Field mean retention time  $T_d$  for given flow rate and ponding conditions and the theoretical residence time  $T$  are related by a hydraulic efficiency correction factor as follows:

$$T_d = \frac{T}{(HECF)} \quad (I-14)$$

where

$T_d$  = mean residence time, hr

$T$  = theoretical residence time, hr

HECF = hydraulic efficiency correction factor ( $HECF > 1.0$ ) defined as the inverse of the

$$\text{hydraulic efficiency, } T_d/T. \quad R_{14} = \frac{\text{area right of profile}}{\text{area Total}} = \frac{\text{area 1230}}{\text{area 1240}} = 0.78$$

I.5.2 The *HECF* can be estimated by several methods.

a. The most accurate estimate is that made from dye tracer studies to determine  $T_d$  at the actual site under operational conditions at a previous time, with the conditions similar to those for the operation under consideration (see Appendix P, “Dye Tracer Technique to Estimate Mean Residence Time and Hydraulic Efficiency”). This approach can be used only for existing sites.

b. Alternatively, the ratio  $T_d/T = 1/HECF$  can be estimated from the equation:

$$\frac{T_d}{T} = 0.9 \left[ 1 - \exp\left(-0.3 \frac{L}{W}\right) \right] \quad (I-15)$$

where  $\frac{L}{W}$  is the length-to-width ratio of the proposed basin. The  $\frac{L}{W}$  ratio can be increased greatly by the use of internal spur dikes, resulting in a higher hydraulic efficiency and a lower required total area.

I.5.3 Determination of placement area geometry. Previous calculations have provided the minimum required surface area for storage  $A_{ds}$ , a minimum required surface area for zone settling (if applicable)  $A_{dz}$ , and a minimum required surface area for flocculant settling  $A_{df}$ . A ponding depth  $H_{pd}$  was also assumed. These values are then used, as described in the following paragraphs, to determine the required placement area geometry. Throughout the design process, the existing topography of the containment area site must be considered since it can have a significant effect on the resulting geometry of the containment area. Any limitations on dike height

should also be determined based on an appropriate geotechnical evaluation of dike stability (see Chapter 4, “Confined [Diked] Placement”).

I.5.3.1 Select the design surface area. Select the design surface area  $A_d$  as the largest of  $A_{ds}$ ,  $A_{dz}$ , and/or  $A_{df}$ . If  $A_d$  exceeds the real estate available for placement, consider a smaller flow rate (dredge size), deeper average ponding depth, chemical clarification, or an alternate site, and repeat the design. If the surface area for an existing site exceeds  $A_d$ , the existing surface area may be used for  $A_d$ .

I.3.5.2 Use the following procedure to compute the height of the dredged material and dikes:

a. Estimate the thickness of the dredged material at the end of the placement operation:

$$H_{dm} = \frac{V}{A_d} \quad (\text{I-16})$$

where

$H_{dm}$  = thickness of the dredged material layer at the end of the dredging operation, ft

$V$  = volume of dredged material in the basin, ft<sup>3</sup> (from Equation I-3)

$A_d$  = design surface area, ft<sup>2</sup> (as determined above)

b. Add the ponding depth and freeboard depth to  $H_{dm}$  to determine the required containment area depth (dike height):

$$H_{dk} = H_{dm} + H_{pd} + H_{fb} \quad (\text{I-17})$$

where

$H_{dk}$  = dike height, ft

$H_{pd}$  = average ponding depth, ft (a minimum of 2 ft is recommended)

$H_{fb}$  = freeboard above the basin water surface to prevent wave overtopping and subsequent damage to confining earth dikes, ft (a minimum of 2 ft is recommended)

I.6 Example Design Calculations for Retention of Solids and Initial Storage. This section presents example manual calculations for containment area designs for the retention of suspended solids and initial storage. The examples are presented to illustrate the use of field and laboratory data, and they include designs for sedimentation, weir design, and requirements for initial storage capacity. Only those calculations necessary to illustrate the procedure are included in the examples.

### I.6.1 Example I: Containment Area Design Method for Sediments Exhibiting Flocculant Settling.

#### I.6.1.1 Project information.

a. Each year an average of 300,000 yd<sup>3</sup> of fine-grained channel sediment is dredged from a harbor. A new in-water containment area is being constructed to accommodate the long-term dredged material placement needs in this harbor. However, the new containment area will not be ready for approximately 2 years. One containment area in the harbor has some remaining storage capacity, but it is not known whether the remaining capacity is sufficient to accommodate the immediate placement requirements. Design procedures must be followed to determine the residence time needed to meet effluent requirements of 4 g/L and the storage volume required for the 300,000 yd<sup>3</sup> of channel sediment. These data will be used to determine if the existing containment area storage capacity is sufficient for the planned dredged material placement activity. The existing containment area is about 3 mi from the dredging activity.

b. Records indicate that for the last three dredgings, a 18 in. pipeline dredge was contracted to do the work. The average working time was 17 hr/day, and the dredging rate was 600 yd<sup>3</sup> of in situ channel sediment per hour. The project depth in the harbor is 50 ft.

I.6.1.2 Results of containment area survey. The existing containment area has the following dimensions:

- a. Size: 96 acres.
- b. Shape: length-to-width ratio of about 3.
- c. Volume: 1,548,800 yd<sup>3</sup> (average depth, from surveys, is 10 ft).
- d. Weir length: 24 ft (rectangular weir).
- e. Minimum ponding depth: 2 ft (assumed).

I.6.1.3 Results of laboratory tests and analysis of data. Sediment and dredging-site water characterization was conducted as described in Chapter 2, "Dredging and Navigation Project Management." A pilot settling test was conducted, and no interface was observed during the first 4 hr of the test. A 8 in. column test was then run to determine flocculant and compression settling properties. The following data were obtained from the laboratory tests:

- a. Salinity of dredging site water: <1 ppt.
- b. Channel sediment in situ water content  $w$ : 85%, equivalent to a void ratio  $e_i$  of 2.29.
- c. Specific gravity  $G_s$ : 2.69.
- d. Grain size analysis indicates approximately 20% of the sediment is coarse grained.

31 Jul 15

e. Observed flocculant settling concentrations as a function of depth (see Table I-2).

f. Determine the percent of initial concentration with time (see Table I-3):

(1) Column concentration at the beginning of tests is 132 g/L.

(2) Concentration at 1 ft level at time = 30 min. is 46 g/L (Table I-2).

(3) Percent of initial concentration =  $46 \div 132 = 0.35 = 35\%$ .

(4) These calculations are repeated for each time and depth to develop Table I-3.

g. Plot the percent of initial concentration versus the depth profile for each time interval from data given in Table I-3 (Figure I-7).

h. Determine concentration as a function of time (15-day settling column data) (Table I-4).

i. Plot time versus concentration from data in Table I-4 as shown in Figure I-8.

Table I-2. Observed Flocculant Settling Concentrations with Depth,<sup>1</sup> in Grams per Liter

Time, min	Depth from Top of Settling Column, ft						
	1	2	3	4	5	6	7
0	132.0	132.0	132.0	132.0	132.0	132	132
30	46.0	99.0	115.0	125.0	128.0	135	146
60	25.0	49.0	72.0	96.0	115.0	128	486
120	14.0	20.0	22.0	55.0	78.0	122	227
180	11.0	14.0	16.0	29.0	75.0	119	
240	6.8	10.2	12.0	18.0	65.0	117	
360	3.6	5.8	7.5	10.0	37.0	115	
600	2.8	2.9	3.9	4.4	14.0	114	
720	1.01	1.6	1.9	3.1	4.5	110	
1020	0.90	1.4	1.7	2.4	3.2	106	
1260	0.83	1.14	1.2	1.4	1.7	105	
1500	0.74	0.96	0.99	1.1	1.2	92	
1740	0.63	0.73	0.81	0.85	0.94	90	

<sup>1</sup> Although a 6 ft (1.8 m) test depth is recommended, an 8 ft (2.4 m) depth was used in this test.

Table I-3. Percent of Initial Concentration with Time<sup>1</sup>

Time T, min	Depth from Top of Settling Column, ft		
	1	2	3
0	100.0	100.0	100.0
30	35.0	75.0	87.0
60	19.0	37.0	55.0
120	11.0	15.0	17.0
180	8.0	11.0	12.0
240	5.0	8.0	9.0
360	3.0	4.0	6.0
600	2.0	2.2	3.0
720	1.0	1.2	1.4

<sup>1</sup> Initial suspended solids concentration = 132 g/L.

Table I-4. Concentration of Settled Solids as a Function of Time

Time, days	Concentration, g/L
1	190
2	217
3	230
4	237
5	240
6	242
7	244
9	249
10	247
15	256

31 Jul 15

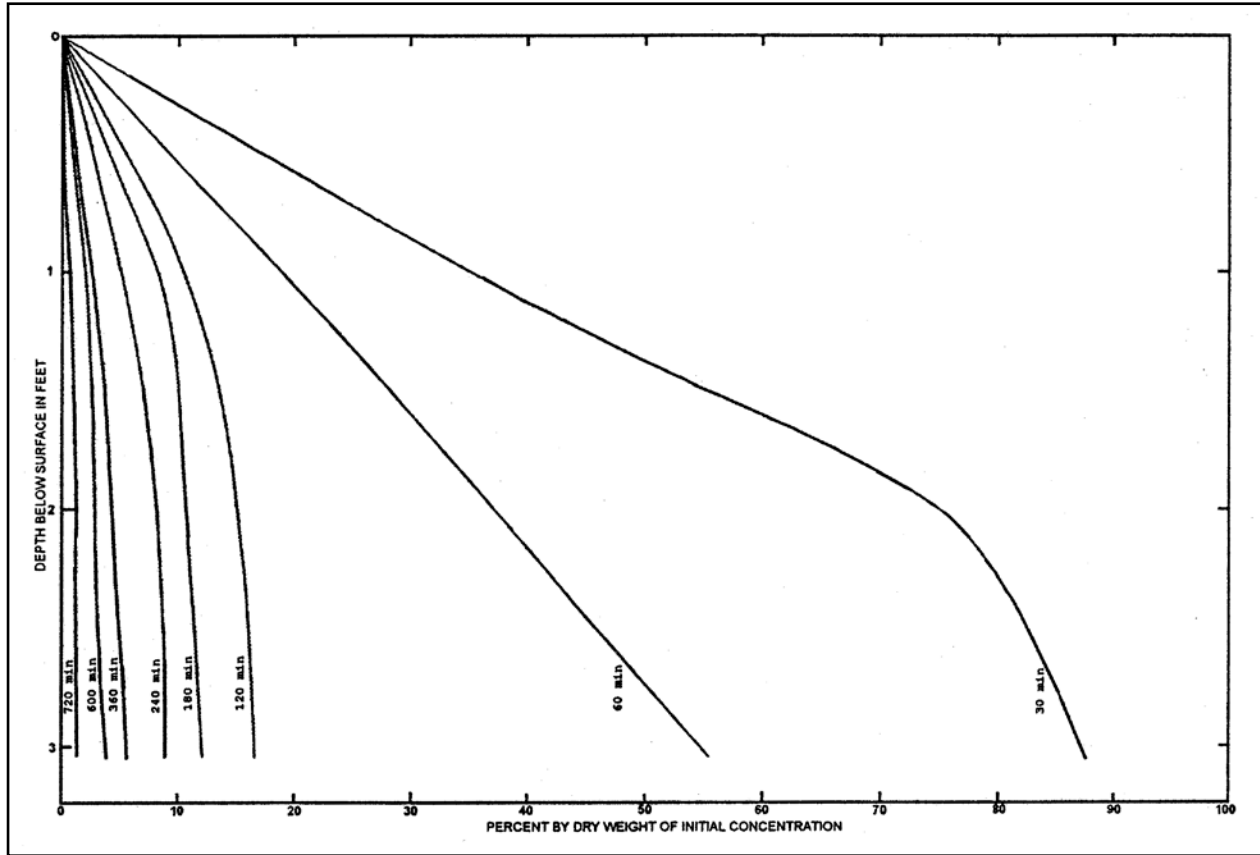

Figure I-7. Percent of Initial Concentration Versus Depth Profile

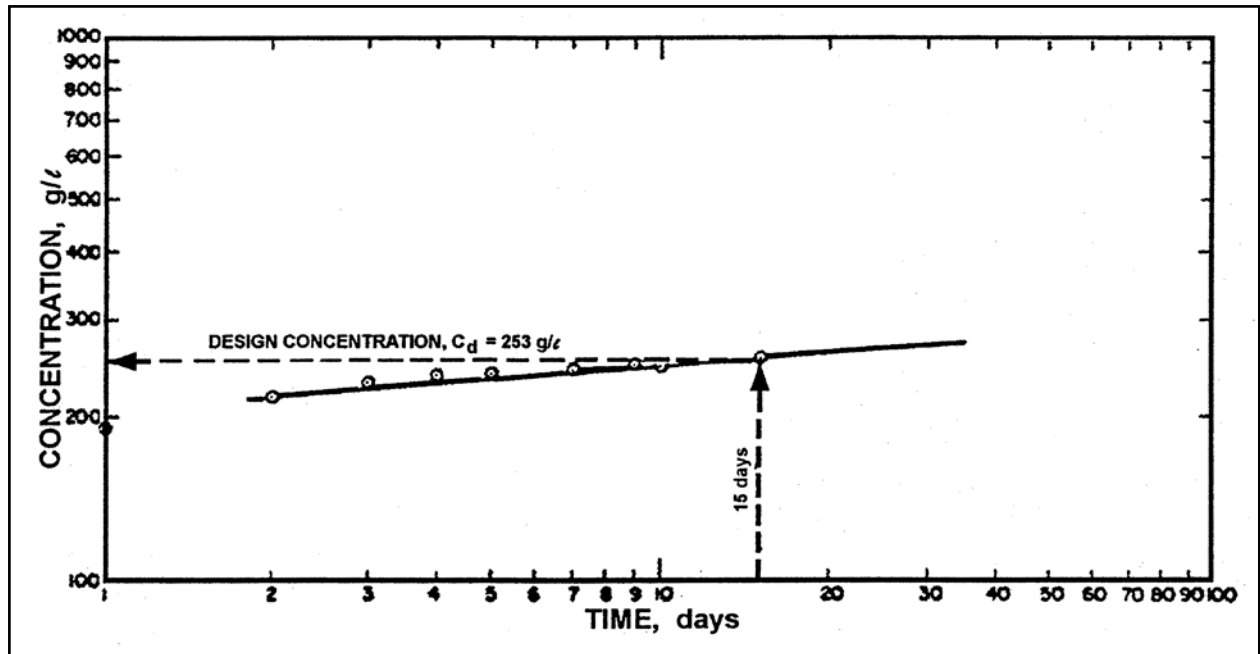

Figure I-8. Time Versus Concentration



I.6.1.4 Design concentration. Compute the design concentration as follows:

a. The project information is as follows:

- (1) Dredge size: 18 in.
- (2) Volume to be dredged: 300,000 yd<sup>3</sup>.
- (3) Average operating time: 17 hr/day.
- (4) Production: 600 yd<sup>3</sup>/hr.

b. Estimate the time of dredging activity:

$$\frac{300,000 \text{ yd}^3}{600 \text{ yd}^3/\text{hr}} = 500 \text{ hr}$$

$$\frac{500 \text{ hr}}{17 \text{ hr/day}} = 29.4(30 \text{ days})$$

c. Average time for initial dredged material consolidation is:

$$\frac{30 \text{ days}}{2} = 15 \text{ days}$$

d. Design solids concentration  $C_d$  is the concentration shown in Figure I-8 at 15 days:

$$C_d = 253 \text{ g/L}$$

I.6.1.5 Volume required for dredged material. Estimate the volume required for dredged material as follows:

a. Compute the average void ratio  $e_o$  using Equation I-1:

$$e_o = \frac{G_s \gamma_w}{C_d} - 1$$

where  $G_s = 2.69$ ;  $\gamma_w = 1,000 \text{ g/L}$ ; and  $C_d = 253 \text{ g/L}$ . Thus,

$$e_o = \frac{2.69(1,000)}{253} - 1$$

$$e_o = 9.63$$

31 Jul 15

b. Laboratory tests indicate that 20% of the sediment is coarse-grained material; therefore, the volume of coarse-grained material  $V_{sd}$  is

$$V_{sd} = 300,000(0.20) = 60,000 \text{ yd}^3$$

and the volume of fine-grained material  $V_i$  is:

$$V_i = 300,000 - 60,000 = 240,000 \text{ yd}^3$$

c. Compute the volume of fine-grained channel sediments after placement in the containment area using Equation I-2:

$$V_f = V_i \left\{ \left( \frac{e_o - e_i}{1 + e_i} \right) + 1 \right\}$$

$$e_i = 2.29$$

$$V_i = 240,000 \text{ yd}^3$$

$$V_f = 775,440 \text{ yd}^3$$

$$V_f = \left[ \frac{9.63 - 2.29}{1 + 2.29} + 1 \right] (240,000)$$

d. Estimate the total volume required in the containment area using Equation I-3:

$$V = V_f + V_{sd}$$

$$V_{sd} = 60,000 \text{ yd}^3$$

$$V = 775,440 + 60,000$$

$$V = 835,440 \text{ yd}^3$$

e. Determine the maximum height of dredged material. Foundation conditions limit dike heights to 10 ft. A ponding depth of 2 ft is assumed using Equation I-4:

$$H_{dm(\max)} = H_{dk(\max)} - H_{pd} - H_{fb}$$

$$H_{dm(\max)} = 10 \text{ ft} - 2 \text{ ft} - 2 \text{ ft}$$

$$H_{dm(\max)} = 6 \text{ ft}$$

f. The minimum surface area that could be used must be compared to the available surface area of 96 acres. Using Equation I-5:

$$A_{ds(\min)} = \frac{V}{H_{dm(\max)}}$$

$$A_{ds(\min)} = \frac{835,440 \text{ yd}^3}{6 \text{ ft}} \times \frac{27 \text{ ft}^3}{\text{yd}^3}$$

$$A_{ds(\min)} = 3,739,480 \text{ ft}^2$$

g. Since the minimum required surface area is less than the available 96 acres, the dredged material can physically be stored during the dredging operation.

I.6.1.6 Residence time required for sedimentation. The design residence time is computed as in the following example:

a. Calculate removal percentages for the assumed ponding depth of 2 ft. Calculating the total area down to a depth of 2 ft from Figure I-7 gives an area of 200 (scale units). Calculating the area to the right of the 30 min timeline down to a depth of 2 ft gives 124 (scale units). These areas could also have been determined by planimetry of the plot. Compute removal percentages as follows (see Equation I-8):

$$R = \frac{124}{200} \times 100 = 62$$

For a settling time of 30 min, 62% of the suspended solids are removed from the water column above the 2-ft depth.

b. Repeat the calculations illustrated in Step a for each time. The results are tabulated in Table I-5.

c. Plot the data in Table I-5, as shown in Figure I-9.

31 Jul 15

$$\frac{T_d}{T} = 0.9 \left[ 1 - \exp\left(-0.3 \frac{L}{W}\right) \right]$$

$$= 0.9 [1 - \exp(-0.3(3))]$$

$$= 0.53$$

$$HCEF = \frac{T}{d}$$

$$= \frac{1}{0.53}$$

$$= 1.87$$

$$T = HECF (T_d)$$

$$= 1.87(365)$$

$$= 683 \text{ min}$$

The required theoretical or volumetric retention time equals 683 min or 11.4 hr.

Table I-5. Removal Percentages as a Function of Settling Time

Time, min	Removal, percentage
30	62.0
60	81.0
120	90.2
180	93.1
240	95.5
360	97.0
600	98.4
720	99.3

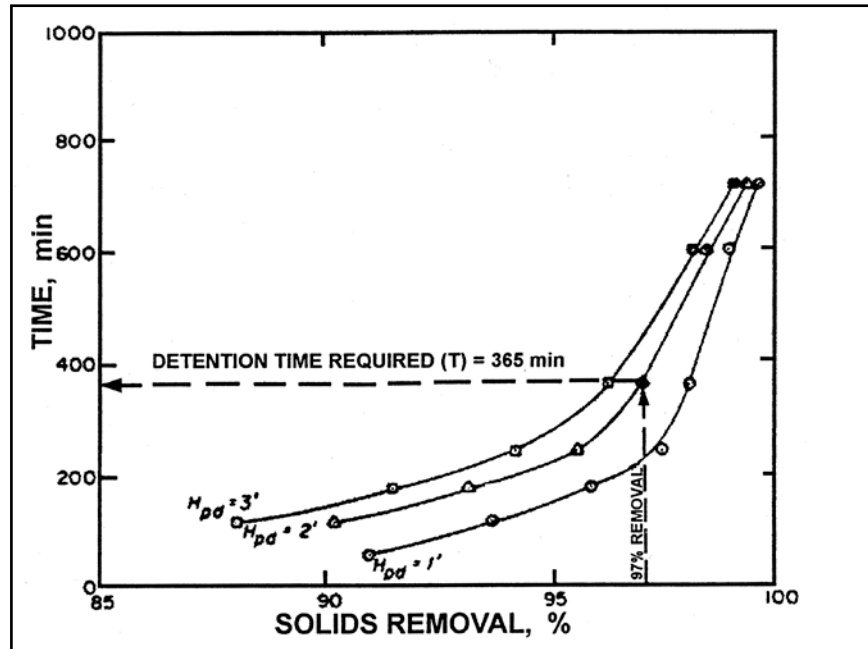

Figure I-9. Solids Removal Versus Time

I.6.1.7 Design surface area required for flocculant sedimentation. Compute this value using Equation I-13 as follows:

$$Q_i = \frac{\left(\frac{18\text{in.}}{12}\right)^{2\pi}}{4} \times 15 \frac{\text{ft}}{\text{sec}}$$

$$= 26.5 \frac{\text{ft}^3}{\text{sec}}$$

$$A_{df} = \frac{TQ_i}{H_{pd}(12.1)}$$

$$= \frac{11.4(26.5)}{2(12.1)}$$

$$= 12 \text{ acres}$$

31 Jul 15

I.6.1.8 Design surface area. Since both the  $A_{ds}$  and  $A_{df}$  are smaller than the available 96 acres, use 96 acres as the design surface area  $A_d$ .

$$A_d = 96 \text{ acres} \times 43,560 \frac{\text{ft}^2}{\text{acre}}$$

$$A_d = 4,181,760 \text{ ft}^2$$

I.6.1.9 Thickness of dredged material layer. Determine the thickness of the dredged material layer from as follows:

$$H_{dm} = \frac{V}{A_d}$$

$$= \frac{835,440 \text{ yd}^3 \times 27}{4,181,760 \text{ ft}^2}$$

$$H_{dm} = 5.4 \text{ ft}$$

I.6.1.10 Required containment area depth (dike height). Determine the required containment area depth as follows:

$$D = 9.4 \text{ ft is less than the maximum allowable dike height of 10 ft.}$$

I.6.1.11 Weir length.

a. The existing effective weir length  $L_e$  equals the weir crest length  $L$  for rectangular weirs:

$$L_e = 24 \text{ ft}$$

$$Q_i = 26.5 \frac{\text{ft}^3}{\text{sec}}$$

$$H_{pd} = 2 \text{ ft}$$

Using Figure I-10, a 2-ft ponding depth at the weir requires an effective weir length of approximately 60 ft. The existing 24-ft weir length is therefore inadequate, and additional weir length should be provided.

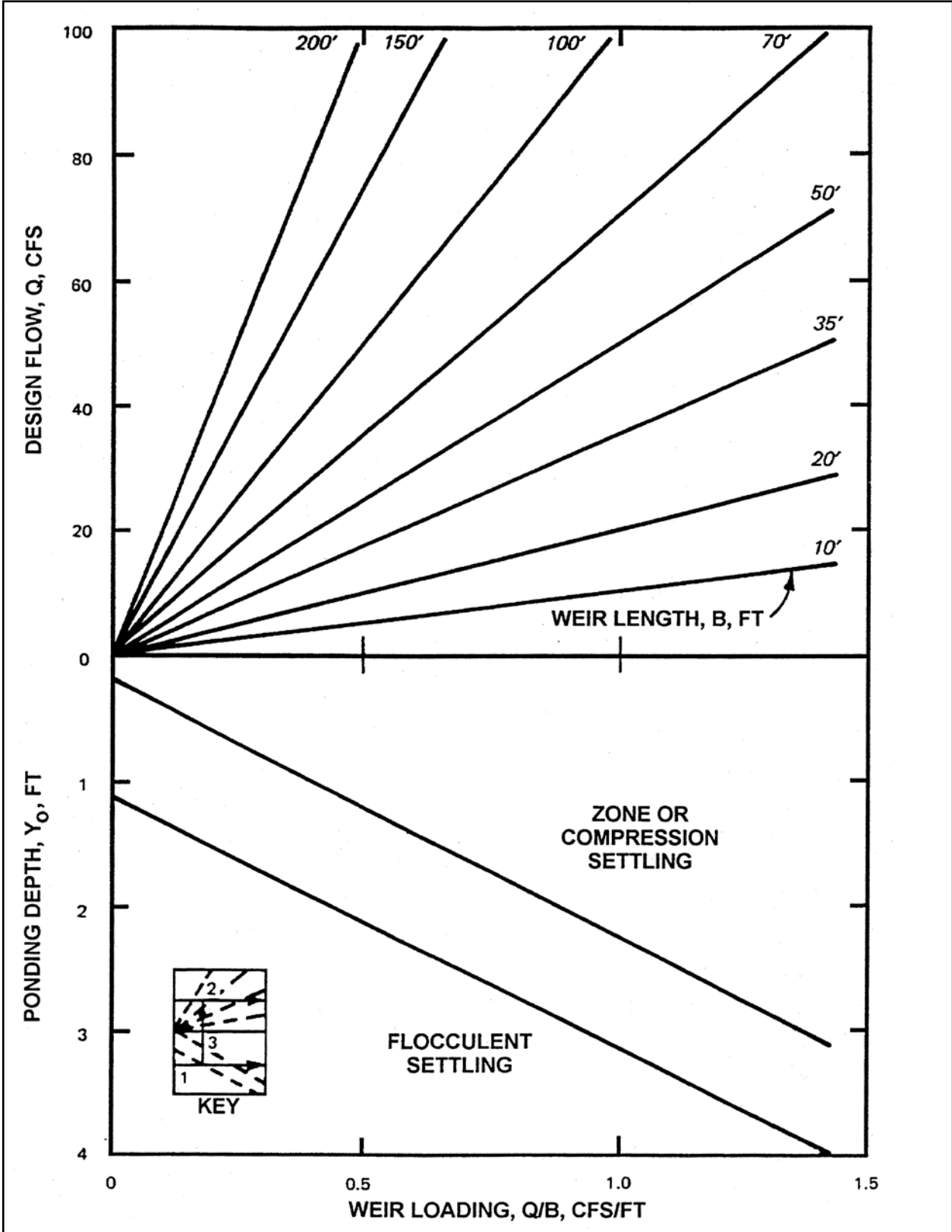

Figure I-10. Weir Design Nomograph

31 Jul 15

b. The remaining volume of 1,548,800 yd<sup>3</sup> in the existing containment area is sufficient to accommodate placement of the 300,000 yd<sup>3</sup> of maintenance channel sediment into the basin under a continuous placement operation. Since the required basin depth is less than the existing depth, no upgrading will be necessary to accommodate the first dredging operation.

#### I.6.2 Example II: Containment Area Design Method for Sediments Exhibiting Zone Settling.

I.6.2.1 Project information. Fine-grained maintenance dredged material is scheduled to be dredged from a harbor maintained to a project depth of 50 ft. Channel surveys indicate that 500,000 ft<sup>3</sup> of channel sediment must be dredged. All available placement areas are filled near the dredging activity, but an available tract of 80 acres is available for a new site 2 miles from the dredging project. An evaluation of the foundation conditions indicate that the maximum allowable dike height is 15 ft. The containment area must be designed to accommodate initial storage requirements while meeting effluent suspended solids levels of 75 mg/L. In the past, the largest dredge contracted for the maintenance dredging has been a 24-in. pipeline dredge. This is the largest size dredge located in the area.

I.6.2.2 Results of laboratory tests. Sediment and dredging site water characterization was conducted as described in Chapter 2, "Dredging and Navigation Project Management." A pilot settling test was conducted, and an interface was observed within a few hours. A column settling test for zone settling was then conducted as described in Appendix H. Flocculant settling data were collected above the interface. The test was also continued for 15 days for purposes of evaluating initial storage requirements. The following data were obtained from the laboratory tests:

- a. Salinity: 15 ppt.
- b. Channel sediment in situ water content  $w$ : 92.3%, equivalent to a void ratio  $e_i$  of 2.5.
- c. Specific gravity  $G_s$ : 2.71.
- d. Depth to suspended solids interface as a function of time for a series of zone settling tests (see Table I-6).
- e. Concentration of settled material as a function of time data (15-day settling column data) (Table I-7).
- f. Concentration of settled solids versus time curve (see Figure I-11).



Table I-6. Depth to Solids Interface as a Function of Settling Time at  $C_i = 150$  g/L

Time, hr	Depth, ft
0	0
0.25	0.050
0.50	0.090
0.75	0.170
1.0	0.230
2.0	0.420
3.0	0.475
4.0	0.505
5.0	0.530
6.0	0.553
7.0	0.565
8.0	0.575
10.0	0.595
20.0	0.655
30.0	0.690

Note: From plot of depth versus time  $V_s = 0.24$  ft/hr.

Table I-7. Concentration of Settled Solids as a Function of Time<sup>1</sup>

Time, days	Concentration, g/L
1	192
2	215
3	219
4	140
5	251
6	272
8	280
10	290
15	320

<sup>1</sup> See Figure I-9.

31 Jul 15

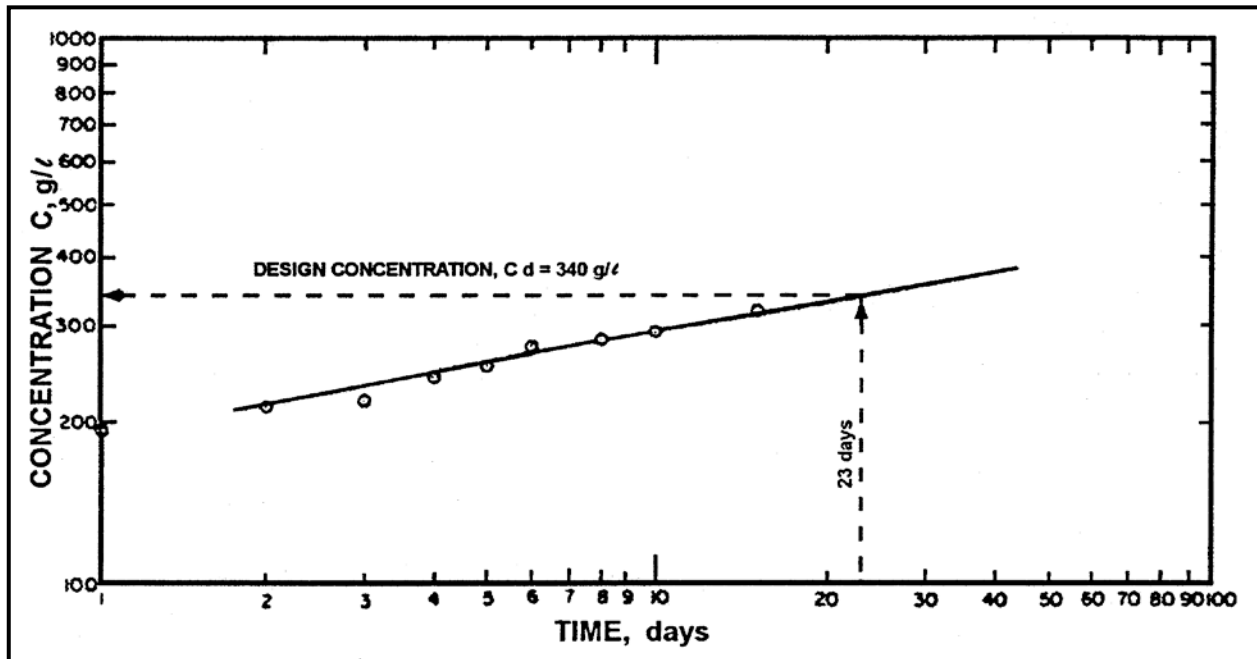

Figure I-11. Concentration of Settled Solids Versus Time

g. Representative samples of channel sediments tested in the laboratory indicate that 15% of the sediment is coarse-grained material (> No. 200 sieve).

$$V_{sd} = 500,000(0.15) = 75,000 \text{ yd}^3$$

$$V_i = 500,000 - 75,000 = 425,000 \text{ yd}^3$$

where

$V_{sd}$  = volume of sand (use 1:1 ratio),  $\text{ft}^3$  (Section I.2.3[3])

$V_i$  = volume of the fine-grained channel sediments,  $\text{ft}^3$  (Section I.2.3[2])

h. Suspended solids concentration data for port samples taken above the interface for the flocculant test (Table I-8).

Table I-8. Observed Flocculant Settling Data

Sample	Extraction Time t, hr	Depth of Sample Extraction z, ft	Total Suspended Solids C, mg/L	Fraction of Initial $\phi$ , %
	3	0.2	93	55
	3	1.0	169	100
	7	1.0	100	59
	7	2.0	105	62
	14	1.0	45	27
	14	2.0	43	25
	14	3.0	50	30
	24	1.0	19	11
	24	2.0	18	11
	24	3.0	20	12
	48	1.0	15	9
	48	2.0	7	4
	48	3.0	14	8

i. Concentration profile diagram plotted from data in Table I-8 (Figure I-12). The initial supernatant suspended solids concentration  $C_o$  was assumed equal to the highest concentration of the first port samples taken, 169 mg/L. The concentration profile diagram was, therefore, constructed using 169 mg/L as 100%.

31 Jul 15

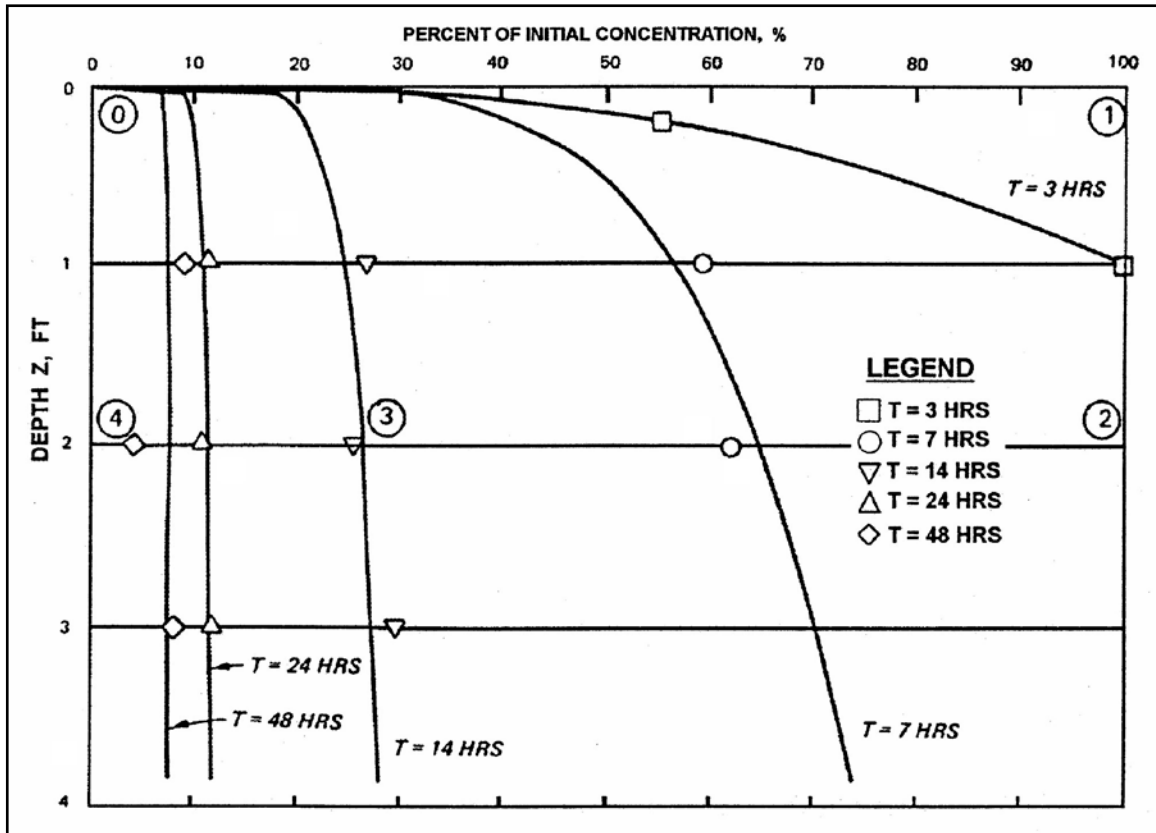

Figure I-12. Suspended Solids Concentration Profile Diagram

I.6.2.3 Design concentration. Compute this value as follows:

a. The project information is as follows:

- (1) Dredge size: 24 in.
- (2) Volume to be dredged: 500,000 yd<sup>3</sup>.

b. Good records are available from past years of maintenance dredging in this harbor. They show that each time a 24-in. dredge was used, the dredge operated an average of 12 hr/day and dredged an average of 900 yd<sup>3</sup>/hr.

c. Estimate the time of dredging activity:

$$\frac{500,000 \text{ yd}^3}{900 \frac{\text{yd}^3}{\text{hr}}} = 556 \text{ hr}$$

where operating time per day = 12 hr. Thus,

$$\frac{556 \text{ hr}}{12 \frac{\text{hr}}{\text{day}}} = 46 \text{ days}$$

d. Average time for dredged material consolidation:

$$\frac{46 \text{ days}}{2} = 23 \text{ days}$$

e. Design concentration is the solids concentration of settled solids shown in Figure I-11 at 23 days:

$$C_d = 340 \frac{\text{g}}{\text{L}}$$

$$\text{or } 21.1 \text{ lb/ft}^3$$

I.6.2.4 Volume required for dredged material. This volume is estimated as follows:

a. Compute the average void ratio using Equation I-1:

$$e_o = \frac{G_s \gamma_w}{C_d} - 1$$

$$G_s = 2.71$$

$$\gamma_w = 1,000 \frac{\text{g}}{\text{L}}$$

$$C_d = 340 \frac{\text{g}}{\text{L}}$$

$$e_o = \frac{2.71(1,000)}{340} - 1$$

$$e_o = 6.97$$

31 Jul 15

b. Compute the volume of fine-grained channel sediments after placement in containment area using Equation I-2:

$$V_f = V_i \left\{ \left( \frac{e_o - e_i}{1 + e_i} \right) + 1 \right\}$$

$$e_i = 2.5$$

$$V_i = 425,000 \text{ yd}^3$$

$$\begin{aligned} V_f &= \left( \frac{6.97 - 2.50}{1 + 2.50} \right) + (425,000) \\ &= 967,785 \text{ yd}^3 \end{aligned}$$

c. Estimate the volume required by dredged material in containment area using Equation I-3:

$$V = V_f + V_{sd}$$

$$V_{sd} = 72,000 \text{ yd}^3$$

$$V = 967,785 + 75,000$$

$$= 1,042,785 \text{ yd}^3$$

### I.6.2.5 Maximum possible thickness of dredged material at end of placement operation.

a. Because of foundation problems, dike heights are limited to 15 ft. Therefore, the placement area must be increased to accommodate the storage requirements. Use Equation I-4 to determine the allowable dredged material height:

$$H_{dm(\max)} = H_{dk(\max)} - H_{pd} - H_{fb}$$

$$H_{dk(\max)} = 15 \text{ ft}$$

$$H_{pd} = 2 \text{ ft}$$

$$H_{fb} = 2 \text{ ft}$$

$$H_{dm(\max)} = 15 - 2 - 2$$

$$H_{dm(\max)} = 11 \text{ ft}$$

b. Compute the minimum possible surface area using Equation I-5:

$$A_{ds} = \frac{V}{H_{d(\max)}}$$

$$A_{ds} = \frac{1,042,785 \text{ yd}^3 \times \frac{27 \text{ ft}^3}{\text{yd}^3}}{11 \text{ ft}}$$

$$A_{ds} = 2,559,563 \text{ ft}^2$$

$$A_{ds} = 59 \text{ acres}$$

Since this value is less than the 80-acre tract available, the dredged material can be physically stored.

I.6.2.6 Minimum area required for zone sedimentation. This value is computed as follows:

a. From data in Table I-6,  $V_s = 0.24 \text{ ft/hr}$ .

31 Jul 15

b. Compute the area requirement using Equation I-6:

$$A_z = \frac{Q_i(3,600)}{V_s}$$

$$Q_i = A_p V_d$$

$$V_p = 15 \frac{\text{ft}}{\text{sec}}$$

$$Q_i = \frac{\left(\frac{24\text{in.}}{12}\right)^{2\pi}}{4} \times 15 \frac{\text{ft}}{\text{sec}} = 47.12 \frac{\text{ft}^3}{\text{sec}}$$

$$A_z = \frac{47.12(3,600)}{0.24} = 706,800 \text{ ft}^2$$

$$A_z = \frac{706,800}{43,560} = 16.22 \text{ acres}$$

c. Increase the area by a factor of 1.87 (from Equation I-15) to account for hydraulic inefficiencies (assuming the containment area can be constructed with a length-to-width ratio of approximately 3):

$$A_{dz} = 1.87(16.22 \text{ acres})$$

$$A_{dz} = 30.3 \text{ acres}$$

Thus, the minimum area required for effective zone settling is 30.3, or approximately 30 acres. This is less than the 80 acres available at the site.

#### I.6.2.7 Retention time for suspended solids removal.

a. A relationship of suspended solids remaining versus retention time was developed using the laboratory data in Figure I-12. Ratios of suspended solids removed as a function of time were determined graphically using the step-by-step procedure described in Section I.3.3. The lower horizontal boundary for the determined areas corresponded to the minimum average ponding depth of 2 ft. An example calculation for removal ratio for the concentration profile at  $T = 14$  hr and ponding depth of 2 ft using Equation I-8 is as follows:

$$R_{14} = \frac{\text{area right of profile}}{\text{area Total}} = \frac{\text{area 1230}}{\text{area 1240}} = 0.78$$



The areas were determined by planimeter. The portion remaining at  $T = 14$  hr is found using Equation I-10 as follows:

$$P_{14} = 1 - R_{14} = 1 - 0.78 = 0.22$$

The concentration of suspended solids remaining is found using Equation I-11 as follows:

$$C_{14} = P_{14}C_o = 0.22 (169 \text{ mg/L}) = 37 \text{ mg/L}$$

Values at other times were determined in a similar manner. The data were arranged in Table I-9. A curve was fitted to the data for total suspended solids versus retention time and is shown in Figure I-13.

Table I-9. Percentage of Initial Concentration and Suspended Solids Concentration versus Time, Ponding Depth of 2 Ft

Sample Extraction Time $t$ , hr	Removal Percentage $R_t$	Remaining Percentage $P_t$	Suspended Solids, mg/L)
3	14	86	145
7	47	53	90
14	78	22	37
24	90	10	17
48	94	6	10

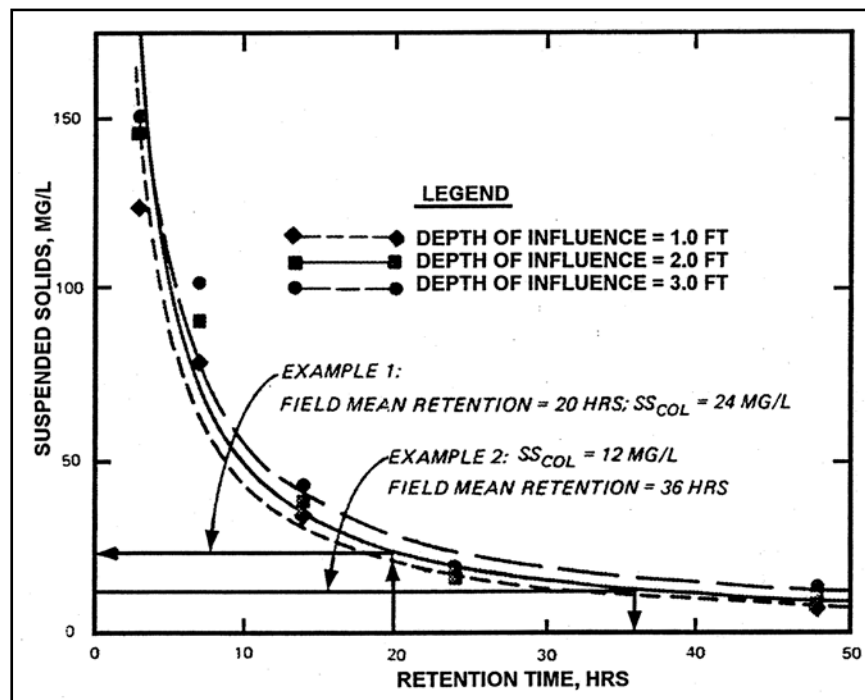

Figure I-13. Plot of Supernatant Suspended Solids Concentration Versus Time from Column Settling Tests

31 Jul 15

b. Since the final site configuration is not known beforehand, an appropriate value should be selected from Table I-1 for the resuspension factor. The minimum ponding depth of 2 ft required by the site design is used. A resuspension factor of 1.5 was selected corresponding to an available area <100 acres and ponding depth of 2 ft.

c. The value of effluent suspended solids of 75 mg/L, which must be met at the point of discharge, considers anticipated resuspension. The corresponding value for total suspended solids concentration under quiescent settling conditions is determined using Equation I-12 as follows:

$$C_{col} = \frac{C_{eff}}{RF} = \frac{75 \text{ mg/L}}{1.5} = 50 \text{ mg/L}$$

d. The required configuration of the placement area must correspond to a retention time that will allow the necessary sedimentation. Using Figure I-13, 50 mg/L corresponds to a field mean retention time of 10 hr. To determine the required placement site geometry, the theoretical retention time should be used. The hydraulic efficiency correction factor was calculated from Equation I-14 to be 1.87 for an L/W of 3. The theoretical retention time was calculated using Equation I-8 as follows:

$$T = T_d (HECF) = 10 (1.87) = 18.7 \text{ hr}$$

e. The placement area configuration can now be determined using data on the anticipated flow rate and the theoretical retention time. Since the dredging equipment available in the project area is capable of flow rates up to 47 ft<sup>3</sup>/sec, the high value should be assumed. The ponded area required is calculated using Equation I-13 as follows:

$$\begin{aligned} A_{df} &= \frac{TQ_i}{H_{pd} (12.1)} \\ &= \frac{18.7(47)}{2(12.1)} \\ &= 36 \text{ acres} \end{aligned}$$

The placement site should therefore encompass approximately 36 acres of ponded surface area if the dredge selected for the project has an effective flow rate not greater than 47 ft<sup>3</sup>/sec. In this case, the surface area of 36 acres required to meet the water quality standard is greater than the minimum surface area of 30 acres required for effective zone settling. However, the area required for storage, 59 acres, is the controlling surface area. The design surface area  $A_d$  is therefore 59 acres.

I.6.2.8 Determination of placement area geometry. From previous calculation, the minimum design area is 59 acres as required for initial storage. This corresponds to the following values as previously calculated:

$$H_{dm} = 11 \text{ ft}$$

$$H_{pd} = 2 \text{ ft}$$

$$H_{fb} = 2 \text{ ft}$$

$$A_d = 59 \text{ acres}$$

I.6.2.9 Design for the weir.

a. The design parameters are as follows:

$$Q_i = 47 \text{ ft}^3/\text{sec}$$

$$H_{pd} = 2 \text{ ft}$$

b. Using Figure I-10, approximately 55 ft of effective weir length is required.

EM 1110-2-5025  
31 Jul 15

THIS PAGE INTENTIONALLY LEFT BLANK

## APPENDIX J

### Dredged Material Consolidation Test Procedures

J.1 General. The accuracy of any calculation of the consolidation behavior of fine-grained dredged material is only as good as the soil parameters used. It is, therefore, very important that the necessary time and resources be allocated to field sample testing and interpretation of the results. Procedures for obtaining sediment samples are found in Chapter 2, “Dredging and Navigation Project Management.” This appendix describes methods of consolidation testing, recommended oedometer test procedures for dredged material, and test data interpretation.

#### J.2 Consolidation Testing.

J.2.1 General. There are essentially three methods of conducting consolidation tests on fine-grained dredged material. They are the self-weight settling test, the controlled rate of strain test, and the oedometer test. Each of these methods has its advantages and disadvantages, and a combination is usually desirable.

J.2.2 Self-weight settling test (Figure J-1). The self-weight settling test is advantageous in determining the void ratio-effective stress relationship at very low levels of effective stress. However, to cover the range of stresses encountered during the consolidation of a prototype dredged fill deposit, the settling column height must equal that of the prototype. If the settling column height equals that of the dredged fill layer, then the time required to complete the test could be on the order of years for typical layers. This is not practical in most situations; so for efficiency, the settling test should be supplemented with one of the other tests for the higher effective stresses.

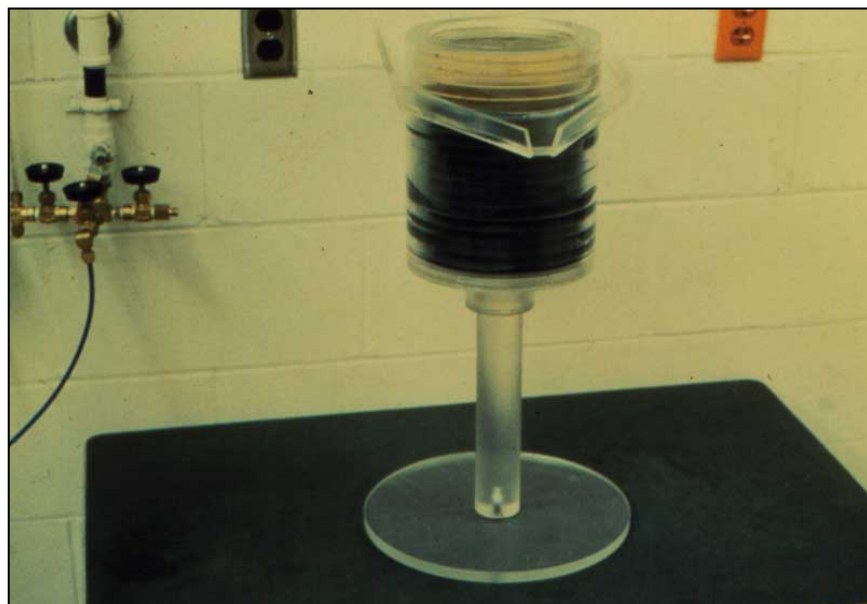

Figure J-1. Self-Weight Consolidation Device

31 Jul 15

J.2.3 Controlled rate of strain test (Figure J-2). A large-strain controlled rate of strain device specifically for the purpose of testing fine-grained dredged material is now under development. When such a device is available, it is recommended that it be routinely used to define consolidation properties at the high void ratios common to dredged fill.

J.2.4 Oedometer test (Figure J-3). The most common type of consolidation testing currently available is the oedometer test. The apparatus required by this test is found in all well-equipped soils laboratories, and the test has been used successfully on numerous dredged materials. Regardless of the disadvantages, because it is the most common and readily available test, the oedometer test is the most attractive for dredged material today. Disadvantages of the test include the following:

a. Void ratio-effective stress relationships at very low levels ( $<0.005 \text{ ton/ft}^2$ ) of effective stress are generally not possible.

b. The time required between load increments may sometimes be 2 weeks or more.

c. Large strains during a given load increment add to the uncertainties of test data analysis for coefficients of consolidation and permeabilities.

d. The question of whether a thin oedometer sample with no initial excess pore pressure when subjected to a sudden load increment reacts the same as an under-consolidated thick sample whose excess pore pressure is slowly decreased.

### J.3 Recommended Oedometer Test Procedure.

J.3.1 Oedometer testing of very soft dredged fill materials is accomplished essentially as specified in EM 1110-2-1906 for stiffer soils. The major difference is in the initial sample preparation and the size of the load increments. The majority of dredged fill samples are in the form of a heavy liquid rather than a mass capable of being handled and trimmed.

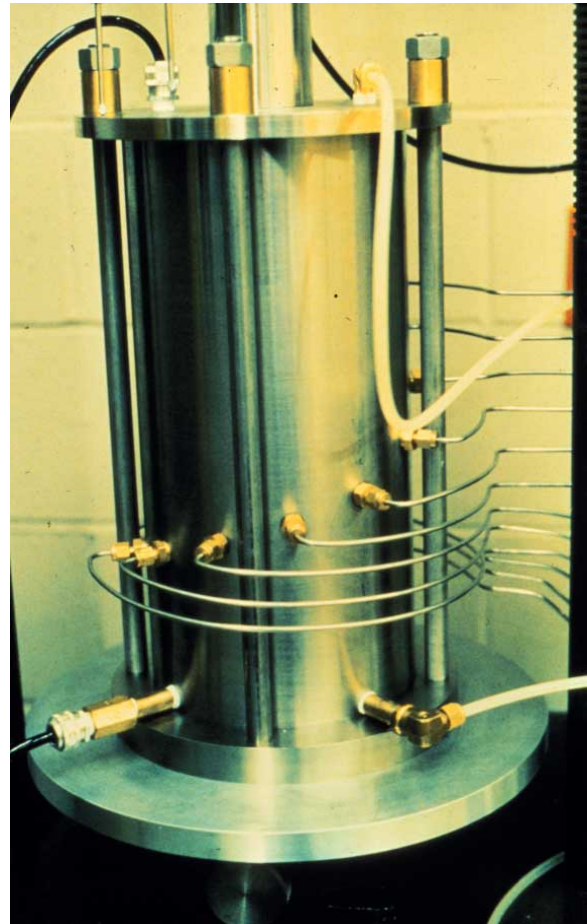

Figure J-2. Large-Strain, Controlled-Rate-of-Strain Test Chamber



Figure J-3. Oedometer Testing Apparatus

J.3.2 Before testing begins, both accurate and buoyant weights of the top porous stone and other items between the sample and dial gage stem should be determined because this will be a major part of the seating load. The force exerted by the dial indicator spring must also be determined for the range of readings initially expected because this will constitute the remainder of the seating load and will be considered the first consolidating load applied to the sample. The dial gage force is determined using a common scale or balance. Samples are prepared for testing by placing a saturated bottom porous stone, filter paper, and consolidometer ring on the scale and then recording their weights. Without removing this apparatus from the scale, material is placed in the ring with a spatula. The material is placed and spread carefully to avoid trapping any air within the specimen. After slightly overfilling the ring with material, the excess is screeded with a straightedge, with care being taken not to permit excess material to fall onto the scale. After a level surface flush with the top of the ring is obtained, the ring top is wiped clean and a final weight is recorded.

J.3.3 The ring with bottom stone is next assembled with the remainder of the consolidometer apparatus. Care must be taken not to jar or otherwise disturb the sample during this process. Once the consolidometer is ready, it is placed on the loading platform, and assembly is completed. As soon as the seating load is placed, the water level in the consolidometer should be brought level with the top of the top porous stone and held there through at least the first three load increments or until the difference in the actual weight and buoyant weight of the seating load is insignificant. Thereafter, the level of the water is not important so long as the sample is kept inundated.

31 Jul 15

J.3.4 Since some consolidation normally occurs very rapidly when the seating load is placed, it is important that this first load is placed very quickly to include the dial gage. If all induced settlement is not accounted for, later calculations may be inconsistent. It may be necessary to use a table level or some other measuring device to check the height of the top of the porous stone above the sample ring at some time during this first load increment. Of course, the thickness of the top porous stone and filter paper must have been measured previously. In this way, a reconciliation between deformation recorded by the dial gage and actual deformation can be made.

J.3.5 After the sample has been subjected to the seating load, dial gage readings are taken at 0.1, 0.2, 0.5, 1.0, 2.0, 4.0, 8.0, 15.0, and 30.0 minutes; 1, 2, 4, 8, and 24 hours; and then daily thereafter until primary consolidation is complete as determined by the time-consolidation curve. The first series of readings is valid for determination of the first point of the  $e$ -log- $\sigma'$  curve and may be used in coefficient of consolidation or permeability determinations if the seating load is placed quickly and in a manner so as not to induce extraneous excess pore pressures.

J.3.6 Consolidation of the sample is continued according to the following recommended loading schedule: 0.005, 0.01, 0.025, 0.05, 0.10, 0.25, 0.50, and 1.00 ton/ft<sup>2</sup>. Exactly what the first load increment will equal depends on the weight of the top porous stone, loading column, and dial gage force. To keep the dial gage force relatively constant throughout testing, the dial gage may have to be reset periodically. If so, it should be reset just before the next load increment is placed and not during a load increment. If consolidation behavior at loads much greater than about 1.0 ton/ft<sup>2</sup> is required, it is recommended that samples which have been preconsolidated to 0.5 ton per square foot be used, since most typical dredged fill samples will have undergone more than 50% strain by the time the above loading schedule is completed. Experience has shown that extrapolation of the  $e$ -log- $\sigma'$  curve produced from the recommended loading schedule to lower void ratios should yield reasonably accurate results, providing that the void ratios through the extrapolated range are greater than about 1.0.

J.3.7 When primary consolidation is completed under the final load of the schedule, the difference between the tops of the top porous stone and the top of the sample ring should again be determined by a table level or other measuring device as a second check on final sample height as determined from dial gage readings. This check is considered important, since the dial gage will probably have been reset several times during the loading schedule. Before the dial gage is removed, the sample should be unloaded and allowed to rebound under the seating load and dial gage force only. When the sample is fully rebounded, a final dial gage reading is made, and the sample is removed for water-content and weight-of-solids measurements.

J.3.8 The preceding recommended test procedure is not meant to replace the more comprehensive treatment of EM 1110-2-1906 or other soils testing manuals. Its purpose is merely to point out where the conventional procedure must be modified or supplemented to handle extremely soft dredged fill material. A final recommendation is that a specific gravity of solids test always be accomplished for the actual material consolidated since calculations are very sensitive to this value, and typical estimated values may lead to significant error.



J.4 Calculation of Permeability. Since the conditions of the oedometer test correspond very closely with those assumed in small strain consolidation theory when data are analyzed for each load increment, there is probably no advantage in using the more complicated finite strain theory in deducing permeability. Then the expression can be written as follows:

$$k = \frac{T_u \bar{H}^2 \gamma_w \bar{a}_v}{(1 + \bar{e})t} \quad (\text{J-1})$$

where

$k$  = coefficient of permeability, cm/sec

$T_u$  = time factor for specified percent consolidation

$\bar{H}$  = effective specimen thickness, cm

$\gamma_w$  = unit weight of water

$\bar{a}_v$  = coefficient of compressibility, cm<sup>3</sup>/g

$\bar{e}$  = void ratio

$t$  = time required to reach specified percent consolidation, sec

The bar indicates average values during the load increment. If 50% consolidation is assumed to occur simultaneously with 50% settlement, the equation can be written as follows:

$$k = \frac{0.197 \bar{H}^2 \gamma_w \bar{a}_v}{(1 + \bar{e})t_{50}} \quad (\text{J-2})$$

where  $t_{50}$  is the time required for 50% settlement from the compression-time curve for the particular load increment. The values for  $k$  are then plotted versus  $e$ , and a smooth curve is drawn through the points.

EM 1110-2-5025  
31 Jul 15

THIS PAGE INTENTIONALLY LEFT BLANK

## APPENDIX K

### Jar Test Procedures for Chemical Clarification

#### K.1 General.

K.1.1 Laboratory jar tests. Jar tests have been used to evaluate the effectiveness of various coagulants and flocculants under a variety of operating conditions for water treatment. The procedures and evaluation process (Black et al. 1957) and (Hudson 1981) have been adapted to dredged material (Schroeder 1983). However, conducting jar tests and interpreting the results to determine design parameters are not simple tasks because there are many variables that can affect the tests. Only experience can assist in applying the following jar test procedures to a specific project. Additional information (Jones, Williams, and Moore 1978) is available on equipment requirements and the importance of flocculant type, flocculant concentration, flocculant addition methods, temperature, mixing and test equipment, and intensity and duration of mixing on the jar tests results.

K.1.2 Jar test uses. Jar tests are used in these procedures to provide information on the most effective flocculant, optimum dosage, optimum feed concentration, effects of dosage on removal efficiencies, effects of concentration of influent suspension on removal efficiencies, effects of mixing conditions, and effects of settling time.

K.1.2.1 The general approach used in these procedures is as follows:

a. Using site-specific information on the sediment, dredging operation, containment areas, and effluent requirement, select mixing conditions, suspension concentration, settling time, and polymers for testing.

b. Prepare a stock suspension of sediment.

c. Test a small number (4-6) of polymers that have performed well on similar dredged material. The tests should be run on 2-g/L suspensions, which is a typical concentration for effluent from a well-designed containment area for freshwater sediments containing clays. If good removals are obtained at low dosages (10 mg/L or less), then select the most cost-effective polymer. If good removals are not obtained, examine the polymer under improved mixing and settling conditions and test the performance of other flocculants.

d. After selecting a polymer and its optimum dosage, examine the effect of polymer feed concentration over the range of 1-30 g/L, typical concentrations used in the field, at the optimum dosage.

e. Determine dosage requirements for the expected range of turbidity and suspended solids concentration to be treated at the primary weir.

f. Examine the effects of the range of possible mixing conditions on the required dosage of flocculant for a typical suspension.

31 Jul 15

g. Examine the effects of settling time on the removal of suspended solids and turbidity from a suspension of average concentration, using the selected dosage and likely mixing conditions.

K.1.2.2 The purpose of the approach described is to select an effective polymer for a suspension of a standard concentration, 2 g/L, which is a typical effluent solids concentration. In this manner, the effectiveness and dosage requirements of various polymers are easy to compare. The other test variables are set to simulate anticipated field conditions. After a polymer is selected, other variables are examined: polymer feed concentration, solids concentration of suspension to be treated, and mixing and settling time. The approach may be changed to fit the needs and conditions of the specific study.

K.1.2.3 Typically the details of each test are modified to satisfy the constraints and conditions of the project and test. This procedure generally requires judgment from experience with jar tests and chemical treatment. Detailed procedures are found in the following paragraphs.

## K.2 Selection of Test Conditions.

K.2.1 Mixing intensity and duration. Prior to testing, the mixing intensity and duration for the jar tests should be selected based on project conditions. Assuming that mechanical mixing will not be used in the treatment system, the amount of mixing should be based on the available head between the two containment areas (in other words, the difference between the water surfaces of the two areas that can be maintained throughout the project) (Figure K-1). The depth of the secondary area must be sufficient to provide 2-3 ft of storage and 2-3 ft of ponding for good settling. Preferably, 2-3 ft of head should be available for mixing. The object is to convert the head into mixing energy in the culverts joining the two containment areas. The amount of head loss is a function of flow rate, culvert diameter, and length. Table K-1 presents typical mixing values for good culvert mixing designs under a variety of conditions assuming a maximum of five culverts and a maximum culvert length of 100 ft. The net mixing  $G_t$  is the product of the mean velocity gradient (intensity) and the duration. The mixing intensity in terms of the mean velocity gradient  $G$  for the design conditions in Table K-1 varied from about 250 to 500  $\text{sec}^{-1}$ . The effectiveness of polymers increased as the mixing  $G_t$  increased to about 30,000.

a. The designer may select a  $G_t$  value from Table K-1 for an example with similar flow and mixing head, but preferably the designer should calculate the head loss, mixing intensity, and duration for the existing or designed culvert according to the following procedure for pipe flow (Streeter 1971). Assuming a submerged inlet and outlet and corrugated metal pipe,

$$H = \left( 1.5 + \frac{Lf}{D} \right) \frac{v^2}{2g} \quad (\text{K-1})$$

where

$H$  = head loss, ft

$L$  = culvert length, ft

$f$  = friction factor =  $185 n^2/D^{1/3}$  ( $n$  = Manning's coefficient, 0.024 for corrugated metal pipes)

$D$  = culvert diameter, ft

$v$  = maximum velocity through culvert, ft/sec =  $4 Q_{\max}/\pi D^2$

$Q_{\max}$  = maximum flow rate, ft<sup>3</sup>/sec

$g$  = gravity, 32.2 ft<sup>2</sup>/sec

Alternate methods and sources for friction factor and Manning's coefficient are available in Hydraulics Design Criteria 224-1/2 to 224/1/4. The mean velocity gradient  $G$  can be calculated as follows:

$$G = \sqrt{\frac{\gamma_s f \bar{v}^3}{2gD\mu_s}} \quad (\text{K-2})$$

where

$G$  = mean velocity gradient, sec<sup>-1</sup>

$\gamma_s$  = specific weight, 62.4 lb/ft<sup>3</sup>

$\bar{v}$  = average velocity, ft/sec

$\mu_s$  = absolute viscosity,  $2.36 \times 10^{-5}$  lb/sec/ft<sup>2</sup> at 60 °F

The duration  $t$  of the mixing in seconds is determined by

$$t = \frac{L}{\bar{v}} \quad (\text{K-3})$$

The mixing increases with increases in head loss, culvert length, and duration and with decreases in culvert diameter. Long, multiple, small-diameter, corrugated culverts provide the best mixing conditions. Good mixing requires a  $G_t$  of about 30,000, though a  $G_t$  of about 8,000 provides adequate mixing.

31 Jul 15

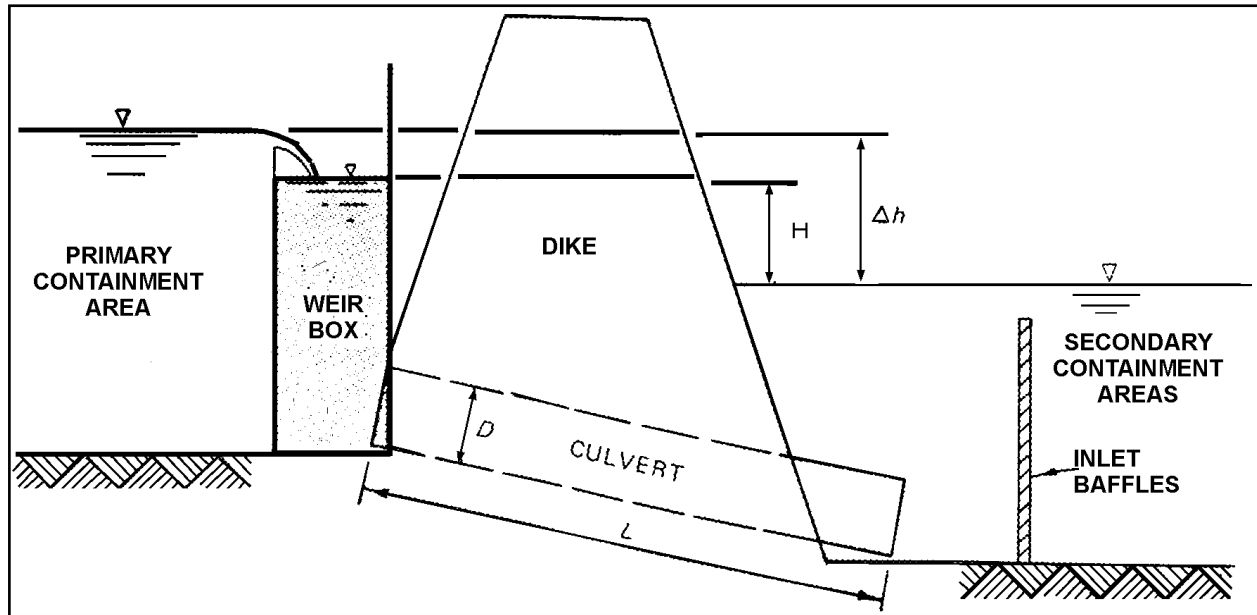

Figure K-1. Example of a Weir Mixing System

Table K-1. Design Mixing Values  $G_t$ 

Flow ft <sup>3</sup> /sec	Available Head, ft				
	2	3	4	5	6
5	8,200	9,800	11,300	12,200	12,900
8	7,800	9,300	10,800	11,600	12,300
12	7,500	9,000	10,400	11,200	11,900
16	7,200	8,700	10,000	10,800	11,500
21	7,000	8,400	9,700	10,500	11,100
27	6,800	8,200	9,500	10,200	10,800
36	6,600	7,900	9,100	9,800	10,400
47	6,400	7,600	8,800	9,500	10,100
60	6,200	7,400	8,500	9,200	9,800
74	6,000	7,200	8,300	8,900	9,500
106	5,700	6,800	7,900	8,500	9,000

b. After determining  $G$  and  $t$  for field conditions, use the same  $G$  and  $t$  for rapid mixing conditions in the laboratory jar test. If the  $G$  is greater than the  $G$  available on the jar test apparatus, mix at maximum speed and increase the duration to obtain the same  $G_t$ . The relationship between  $G$  and revolutions per minute of a jar test apparatus is shown in Figure K-2. For slow mixing, mix at 20 rpm ( $G = 10 \text{ sec}^{-1}$ ) for 300 sec to simulate the exit loss conditions as the water dissipates its kinetic energy upon entering the secondary cell.

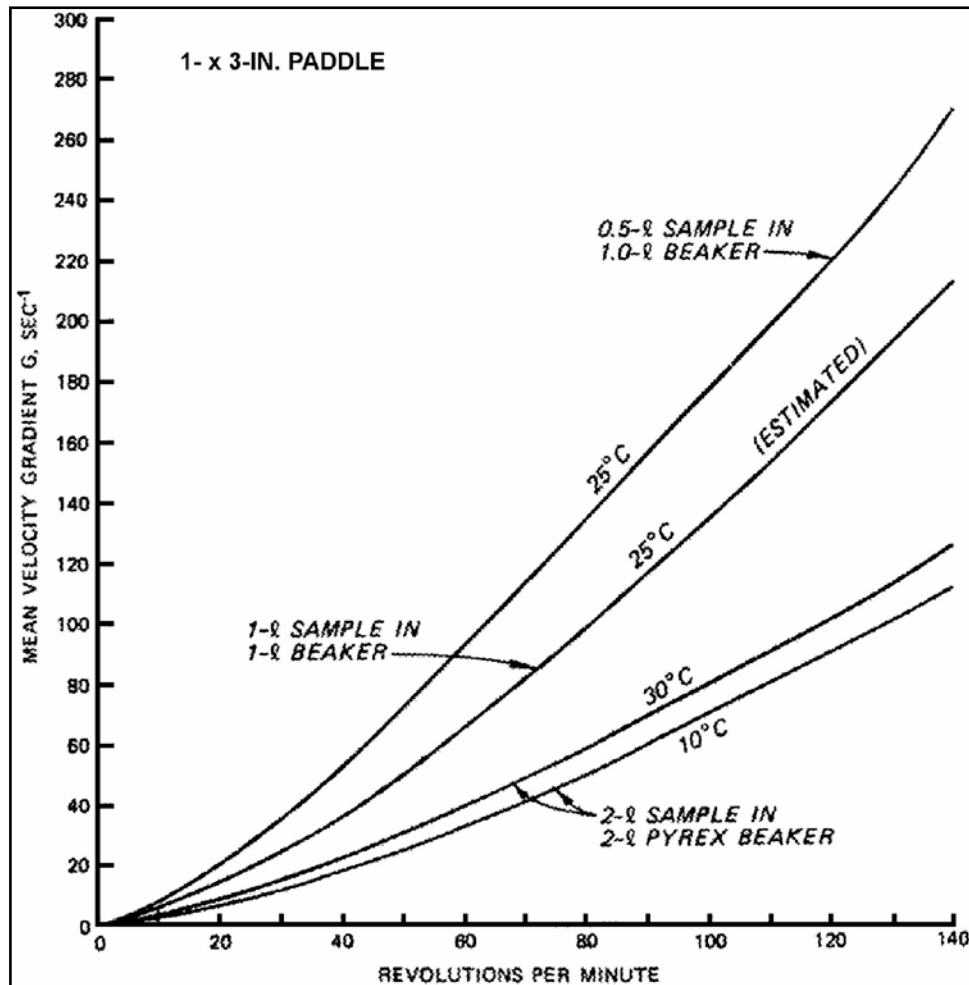

Figure K-2. Velocity Gradient  $G$  Calibration Curves for Jar Test Apparatus

K.2.2 Suspension concentration. The next step is to predict the average solids concentrations and turbidity of the suspension to be treated at the primary weir. This can be estimated from past records of dredging at the site or flocculant settling tests. Procedures for containment area design considering both flocculant and zone settling are found herein. The results of flocculant settling tests, when available, should be used to determine the suspension concentration.

K.2.3 Settling time for flocculated material. The next variable to establish is settling time. Flocculated (chemically treated) material settles at a rate of about 0.25 ft/min. The required ponding depth for good settling is about 2-3 ft; therefore, a minimum of 10 min is needed for settling. Also, due to basin inefficiencies, some of the water will reach the secondary weir in 10-20% of the theoretical residence time. For secondary containment areas, this may be as short as 10-20 min, though the mean residence time may be about 50 min. Based on this information, the settling time in the jar test should be set at 10 min. The effect of settling time on suspended solids removal can be evaluated in the jar test procedures.

31 Jul 15

K.2.4 Selection of polymers for testing. The final consideration before starting the jar tests is the selection of polymers to be tested. To simplify the operation of feeding and dispersing the polymer at the project, a low viscosity liquid polymer should be used. The following list identifies some polymers effective on dredged material:

a. Betz	1180 1190
b. Calgon	M-503
c. Hercofloc	815 849 863 876
d. Magnifloc	573C 577C
e. Nalco	7103 7132

Polymer manufacturers may be able to suggest others. They can also recommend maximum polymer feed concentrations. Polymer selected for testing should be nontoxic, nonhazardous, and unreactive. Polymer manufacturers can provide detailed information on the properties of their products. Also, the U.S. Environmental Protection Agency (USEPA) has approved many polymers for use on potable water at the desired dosages. Very little of an applied dosage is expected to be discharged from the containment area since the polymer adsorbs on the solids and settles in the containment area. Therefore, polymers should not be detrimental to the quality of the receiving waters. Polymers do not increase the long-term release of contaminants or nutrients from treated dredged material (Wang and Chen 1977).

K.2.5 Suspension preparation. Dredged material that is discharged over the weir is composed of only the finest fraction of the sediment. In many cases, this material has been suspended and mixed in the primary containment area for several days while the coarser material settled. Therefore, to obtain representative suspensions for testing, the following procedure is recommended:

a. Thoroughly mix each sediment sample to ensure homogeneity. Then, blend equal portions of each sample to form a representative composite of the sediment. Grain size analysis and soil classification may be performed on this material to characterize the mixture and to compare it with previous characterizations of the sediment.

b. If the sediment mixture contains more than 10% (dry weight basis) coarse-grained (>No. 200 sieve) material, the material should be sieved through a standard U.S. series No. 200 sieve. The fines can be washed through the sieve using water from the bottom of the water



column at the dredging site. If this water is unavailable, tap water may be used in its place, but the salinity of the suspension of fines (<No. 200 sieve) must be adjusted to naturally occurring salinity of the bottom waters at the project site.

c. Prepare a supply of 2.0-g/L suspensions by diluting a well-mixed portion of the slurry of fines with water from the dredging site or with tap water adjusted with salt to the same salinity. Suspensions at other concentrations would be prepared in the same manner.

K.2.6 Jar test procedures. Having established the test variables, the designer is ready to start the laboratory jar test procedures. Care must be exercised in the tests to ensure that each sample is handled uniformly. The tests must be performed in a standard manner to evaluate the results. The following variables must be controlled: identical test equipment and setup, suspension preparation, sample temperature, polymer feed concentration and age, polymer dosage, sample premix time and intensity, polymer addition method, duration and intensity of rapid mixing, duration and intensity of slow mixing, settling time, sampling method, and laboratory analyses of samples. All of the following procedures are not necessary for every project. The required tests are dependent on the purpose of the study, and some tests can be eliminated based on past experience of treating dredged material under similar circumstances.

K.2.6.1 Selection of polymer. The laboratory jar test procedures are as follows:

- a. Step 1—Fill a 1- or 2-L beaker with a 2.0-g/L suspension of fine-grained dredged material.
- b. Step 2—Mix at 100 rpm and incrementally add polymer at a dosing of 2 mg/L until flocs appear. Note the total dosage applied. (Use a polymer feed concentration of 2 g/L or 2 mg/mL.)
- c. Step 3—Fill six 1- or 2-L beakers with a 2.0-g/L suspension of dredged material and measure the suspended solids concentration and turbidity of the suspension.
- d. Step 4—Mix at 100 rpm for 1 min and then rapidly add the desired polymer dosage to each beaker. Use a range of polymer dosages from 0 mg/L to about twice the dosage determined in Step (2).
- e. Step 5—Immediately adjust the mixing to the desired  $G$  for rapid mixing as determined earlier. Mix for the desired duration  $t$  also determined earlier.
- f. Step 6—Reduce the mixer speed to a  $G$  of  $10 \text{ sec}^{-1}$  and slow mix for 300 sec.
- g. Step 7—Turn off the mixer and allow to settle for 10 min.
- h. Step 8—Withdraw the samples from the 700-mL level of 1-L beakers and from the 1,400-mL level of 2-L beakers.
- i. Step 9—Measure the suspended solids concentration and turbidity of the samples. Record the test data on a report form similar to the one shown in Figure K-3. Also record any significant

observations such as nature, size, and settling characteristics of the flocs, time of floc formation, and any peculiarities.

j. Step 10—Repeat Steps (3) through (9) as needed to adequately define the effects of dosage on clarification.

k. Step 11—Repeat Steps (1) through (10) for the other polymers. A dosage of 10 mg/L should reduce the solids concentrations by 95% if the polymer is effective. Examine enough polymers to find at least two effective ones.

l. Step 12—Select the most cost-effective polymer that can be easily fed and dispersed.

K.2.6.2 Selection of polymer feed concentration. After selecting the best polymer, the effects of polymer feed concentration and polymer solution age on the removals can be evaluated. Some polymers require great dilution and aging following dilution to maximize their effectiveness. This test is not required if adequate dilution water and solution aging are provided in the design to meet the manufacturer's recommendations. Often, to simplify the treatment system design, these recommendations are not met. The test is performed as follows:

a. Step 1—Prepare 6 fresh solutions of the selected polymer ranging in concentration from about 1 to 40 g/L.

b. Step 2—Fill 6 beakers as in Step (3) of paragraph K.2.6.1.

c. Step 3—Mix at 100 rpm for 1 min and then rapidly add the polymer solutions at the effective dosage established earlier and in the same manner.

d. Step 4—Continue to follow the procedures outlined in Steps (5) through (9) of paragraph K.2.6.1.

e. Step 5—Allow two solutions to age as desired (between 1 hr and 1 day) and repeat Steps (2) through (4) of this paragraph.

### JAR TEST REPORT FORM

TEST NO. \_\_\_\_\_ DATE \_\_\_\_\_ SAMPLE SOURCE \_\_\_\_\_

COAGULANT \_\_\_\_\_ DOSING METHOD \_\_\_\_\_ TURBIDITY \_\_\_\_\_ pH \_\_\_\_\_

CONC. \_\_\_\_\_ SALINITY \_\_\_\_\_ SS \_\_\_\_\_ TEMP \_\_\_\_\_

JAR NO.		1	2	3	4	5	6
RAPID MIX	RPM						
	TIME, SEC						
SLOW MIX	RPM						
	TIME, SEC						
POLYMER DOSE	mg/l						
	ml						
SAMPLE VOLUME	ml						
SETTLING TIME	MIN						
SUSPENDED SOLIDS AFTER SETTLING	mg/l						
TURBIDITY AFTER SETTLING	NTU'S						

WES FORM 1 DEC 81 2243

Figure K-3. Jar Test Report Form

31 Jul 15

K.2.6.3 Determination of required dosage. The dosage requirements of the selected polymer for the anticipated average solids concentration of the primary effluent suspension to be treated at the primary weir should be evaluated. This concentration was determined previously from past records or flocculant settling tests. The procedure is as follows:

a. Step 1—Fill 6 beakers with suspensions at the desired concentration of the fine-grained fraction of dredged material. Measure the suspended solids concentration and turbidity of the suspension.

b. Step 2—Mix at 100 rpm for 1 min and then rapidly add the desired polymer dosage to each beaker. The range of dosages should be proportional to the solids concentration.

c. Step 3—Continue to follow the procedures outlined in Steps (5) through (10) of paragraph K.2.6.1. Other suspensions with different solids concentrations may be examined in the same manner to determine the possible range of dosages required for the project and the possible range of effluent quality obtainable under conditions of variable primary effluent solids concentration to be treated.

K.2.6.4 Effects of mixing. Other mixing conditions can be examined to determine the impact of low flow conditions and to evaluate whether the mixing is adequate. The effects of increasing the mixing by a  $Gt$  of 5,000 and 10,000 and of decreasing flow rate by 50%, 75%, and 90% on the polymer dosage requirements can be evaluated as follows:

a. Step 1—Calculate the new mixing intensity and duration.

b. Step 2—Fill 6 beakers with a suspension at the anticipated average solids concentration.

c. Step 3—Mix at 100 rpm for 1 min and then rapidly add the desired polymer dosage to each beaker. Select a range of dosages surrounding the optimum dosage determined in the last set of experiments on the same suspension.

d. Step 4—Immediately adjust the mixing to the  $G$  value calculated in paragraph K.2.1 for rapid mixing and mix for the calculated duration  $t$ .

e. Step 5—Follow the procedures outlined in Steps (6) through (9) of paragraph K.2.6.1.

K.2.6.5 Effects of settling time. The effects of settling time on effluent quality can be examined as follows:

a. Step 1—Determine the range of settling time of interest, bearing in mind that the secondary basin will be hydraulically inefficient and the settling conditions will not be quiescent.

b. Step 2—Follow the procedures outlined in Steps (3) through (9) of paragraph K.2.6.1, but adjust the settling time and sampling schedule to cover the range determined above.

## APPENDIX L

## Estimation of Dredged Material Consolidation by Finite Strain Technique

L.1 General. In this appendix, the method for estimating consolidation by finite strain techniques is described. Also, the practical problem of a single dredged fill layer deposited on a compressible foundation is solved for settlement as a function of time by both small strain and linear finite strain theories. The solutions involve only hand calculations and the appropriate percent consolidation curves given previously in this EM.

L.2 Estimation of Consolidation Using the Finite Strain Technique.

L.2.1 Laboratory test data. Consolidation of dredged material due to self weight must be estimated using results from appropriate laboratory tests. The following procedure for hand computation uses standard consolidation (oedometer) laboratory test data. Procedures for these tests are described in Appendix J, "Dredged Material Consolidation Test Procedures." The laboratory tests yield a relationship between void ratio and effective stress as shown in Figure L-1. An exponential form for the relationship should be determined by curve fitting techniques. The fit should be of the form

$$e = (e_{oo} - e_{\infty})\exp(-\lambda\sigma') + e_{\infty} \quad (\text{L-1})$$

where  $e_{oo}$  is void ratio at zero effective stress and  $e_{\infty}$  is the void ratio at infinite effective stress. Such a curve is also shown in Figure L-1, where  $\lambda$ ,  $e_{oo}$ , and  $e_{\infty}$  were chosen to give the best apparent fit to the test data.

L.2.2 Determination of layer thicknesses. The void ratio at the end of the sedimentation phase as well as initial thickness of the deposited layer will be determined from column settling tests as described in Appendix H, "Column Settling Test Procedures." The layer thickness in reduced coordinates for each deposited layer should be calculated as follows:

$$\ell = \frac{h}{(1 + e_{oo})} \quad (\text{L-2})$$

where  $h$  is the layer thickness as deposited, and  $e_{oo}$  is the initial void ratio since the effective stress is assumed initially zero throughout the layer. In a normally consolidated layer or layer having any other than uniform void ratio distribution,  $\ell$  can be calculated to sufficient accuracy by dividing the layer into a number,  $m$ , of sublayers and using

$$\ell = \sum_{i=1}^m \ell_i = \sum_{i=1}^m \frac{h_i}{1 + e_i} \quad (\text{L-3})$$

where  $h_i$  is the sublayer height, and  $e_i$  is the average void ratio in the sublayer. The sublayer void ratio is obtained from the  $e - \log \sigma'$  curve for the material by considering the effective weight of

31 Jul 15

all material and surcharge above the center of the sublayer or by direct measurement of the saturated water content of the sublayer.

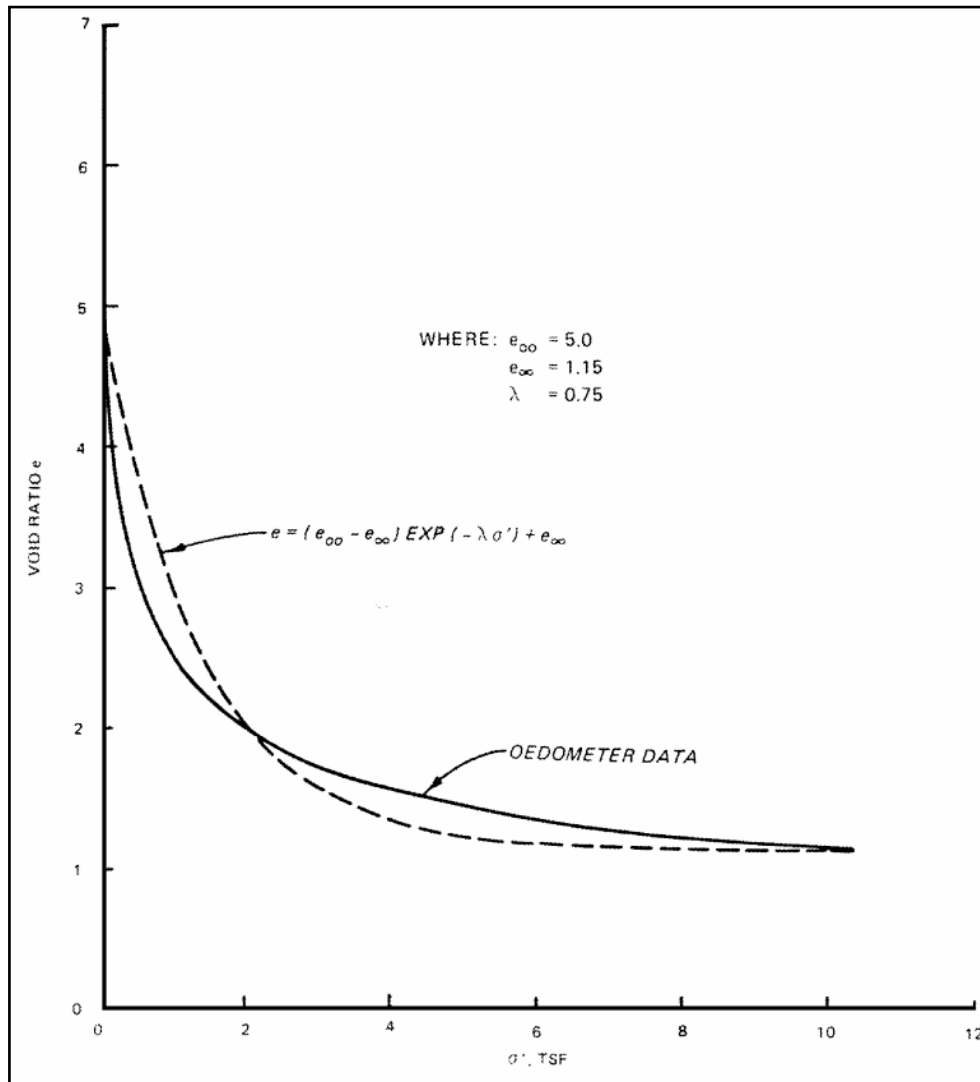

Figure L-1. Exponential Void Ratio-Effective Stress Relationship Compared to Oedometer Data, 0-12.0 tons/ft<sup>2</sup>

### L.2.3 Calculation of ultimate settlement.

a. The ultimate settlement of a consolidating fine-grained layer is defined as that which has occurred after all excess pore pressures have dissipated. Within the layer, the material assumes a void ratio distribution due to the buoyant weight of material above plus any surcharge, and this void ratio is related to the effective stress by the material's  $e$ - $\log$ - $\sigma'$  curve as determined by laboratory testing. Therefore, initial and final void ratio distributions are known or can be calculated.

b. Ultimate settlement is calculated by dividing the total layer into a number,  $m$ , of sublayers such that

$$\delta(\infty) = \sum_{i=1}^m \delta_{i,\infty} = \sum_{i=1}^m (e_{i,o} - e_{i,\infty}) \ell_i \quad (\text{L-4})$$

where  $\delta$  is the settlement,  $\ell_i$  is defined in Equation L-3, and  $e_{i,o}$  and  $e_{i,\infty}$  are the average initial and final void ratios of each sublayer, respectively. The ultimate average effective stress is then calculated for each sublayer by

$$\sigma'_i = \frac{1}{2} \ell_i (\gamma_s - \gamma_w) + \left( \begin{array}{c} \text{effective weight} \\ \text{of all sublayers} \\ \text{above it} \end{array} \right) + (\text{surchage}) \quad (\text{L-5})$$

where the effective weight of each sublayer is  $\ell_i (\gamma_s - \gamma_w)$ . Then, using this average effective stress, an average void ratio is picked from the oedometer test data and substituted into Equation L-4.

#### L.2.4 Calculation of settlement versus time.

a. The coefficient of consolidation for finite strain,  $g$ , should be determined from a plot such as shown in Figure L-2 for the void ratio corresponding to an average effective stress during the consolidation process if the coefficient is relatively constant over the range of expected void ratios. If there is substantial variation in the coefficient of consolidation over the expected range of void ratios, the coefficient can be periodically updated during the calculation to conform to the average void ratio in the layer at the time consolidation is calculated.

b. Calculate nondimensional time factor for the real time in question as follows:

$$T_{fs} = \frac{gt}{\ell^2} \quad (\text{L-6})$$

c. Calculate the dimensionless parameter  $N$  as follows:

$$N = \lambda \ell (\gamma_s - \gamma_w) \quad (\text{L-7})$$

d. Read the percent consolidation,  $U$ , from Figures L-3 through L-6, depending on the value of  $N$  and both initial conditions and boundary conditions for the calculated time factor.

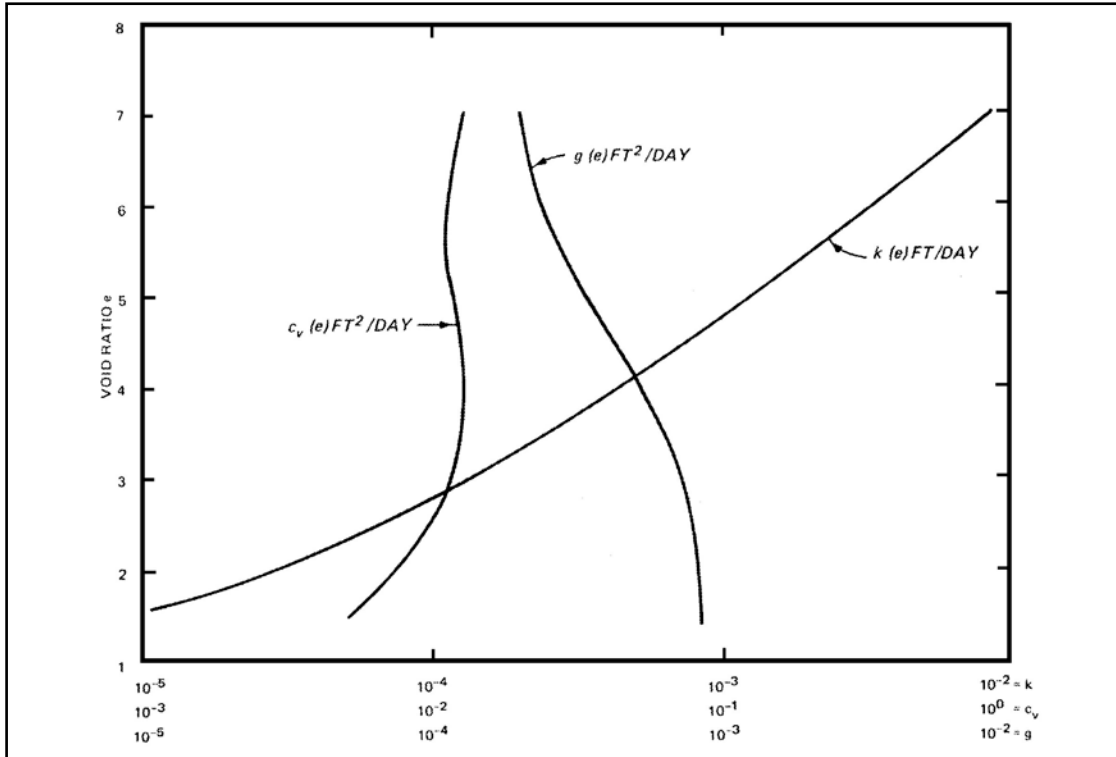

Figure L-2. Typical Permeability and Coefficients of Consolidation as a Function of Void Ratio

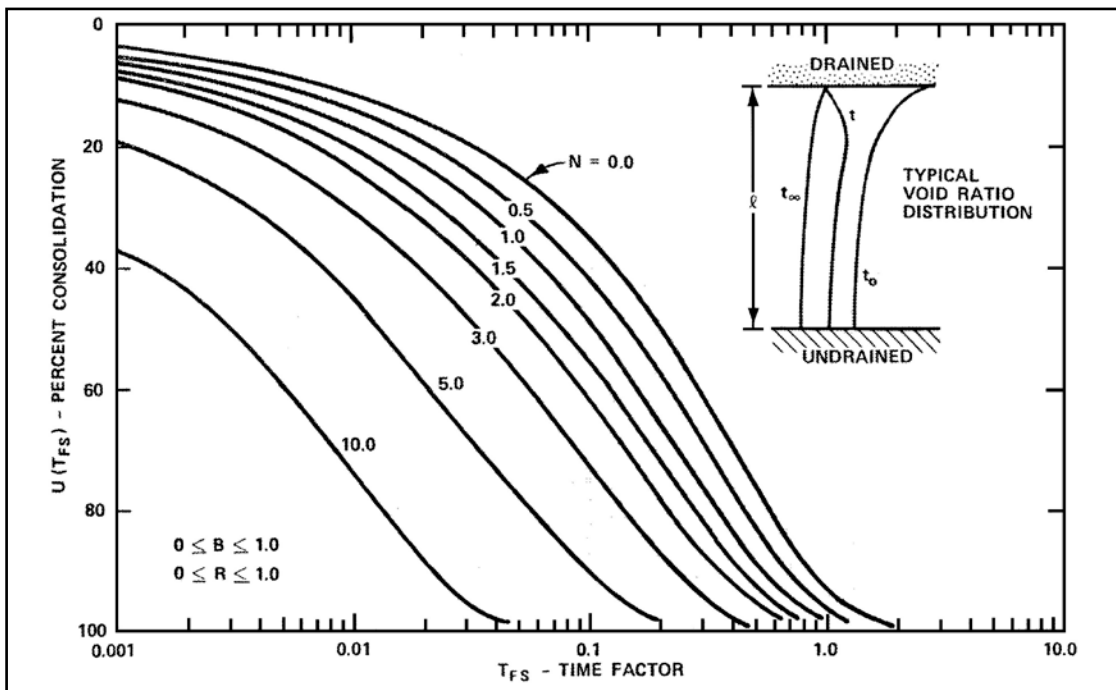

Figure L-3. Degree of Consolidation as a Function of the Time Factor for Normally Consolidated, Singly Drained Layers by Linear Finite Strain Theory



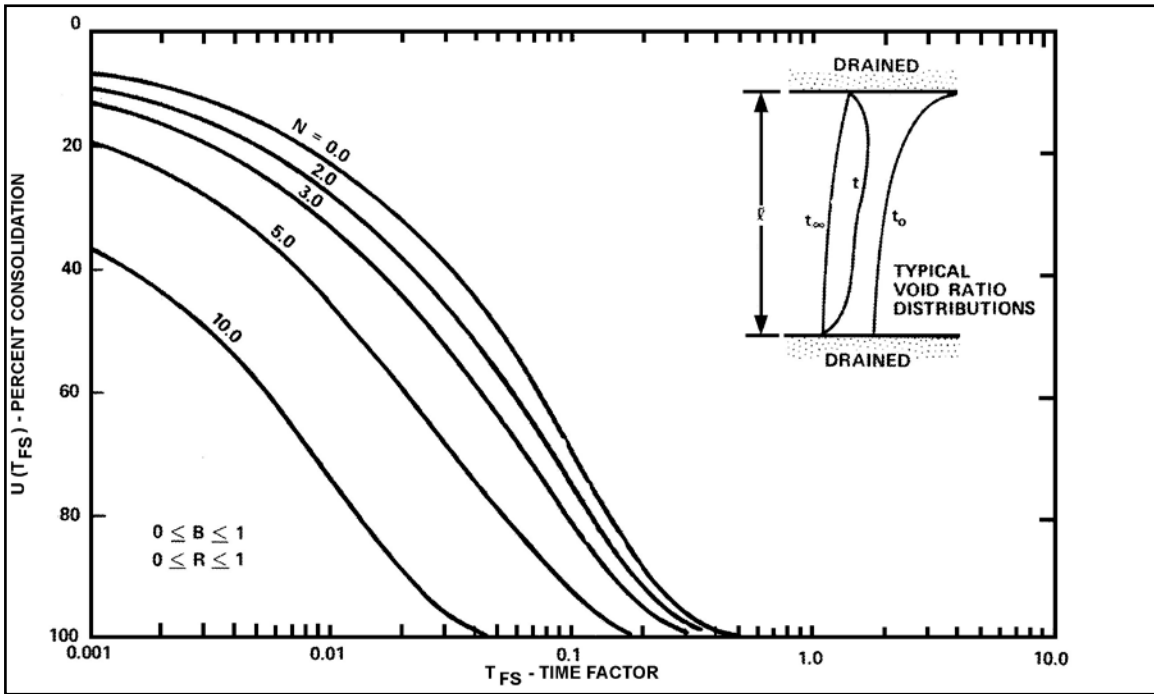

Figure L-4. Degree of Consolidation as a Function of the Time Factor for Normally Consolidated, Doubly Drained Layers by Linear Finite Strain Theory

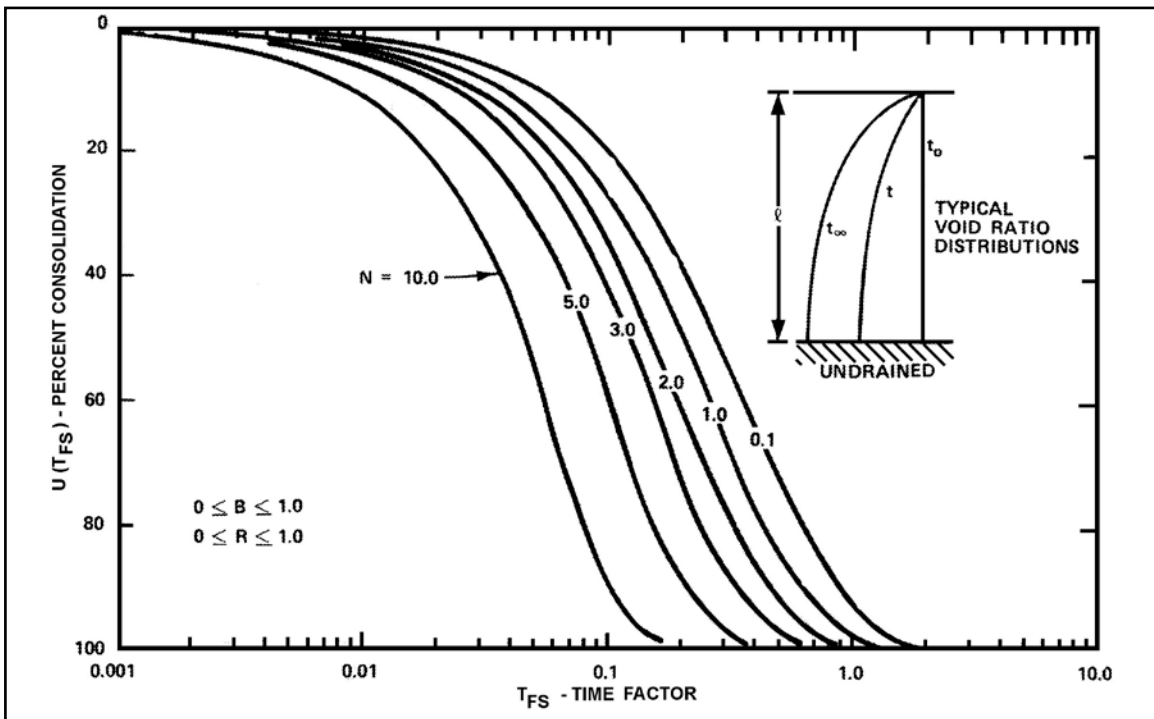

Figure L-5. Degree of Consolidation as a Function of the Time Factor for Dredged Fill, Singly Drained Layers by Linear Finite Strain Theory

31 Jul 15

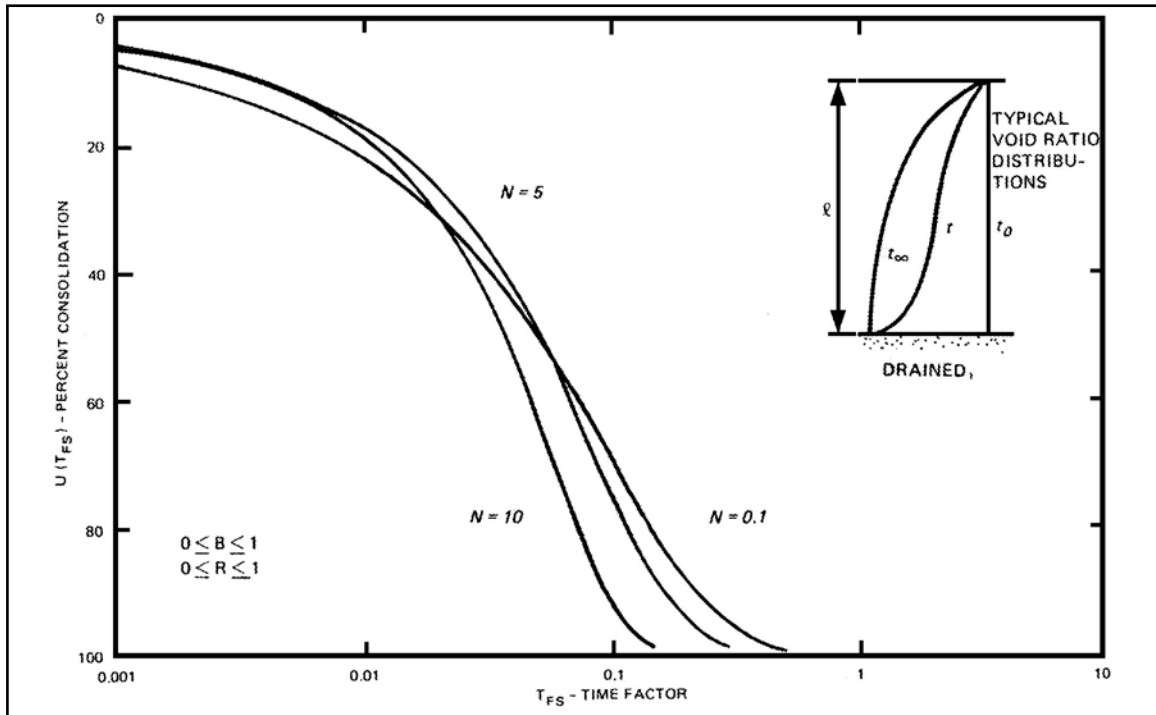

Figure L-6. Degree of Consolidation as a Function of the Time Factor for Dredged Fill, Doubly Drained Layers by Linear Finite Strain Theory

e. With the percent consolidation known, settlement is then at the real time  $t$  chosen in calculating  $T_{fs}$ .

$$\delta(T_{fs}) = \delta_{\infty} \cdot U(T_{fs}) \quad (\text{L-8})$$

f. An example of this procedure for a single dredged fill layer deposited on a compressible foundation is solved in Equation L-4 by both a small strain and linear finite strain formulation. In the example, an updated coefficient of consolidation and layer height are used in calculating the dimensionless time factor.

### L.3 Empirical Estimate of Settlement due to Desiccation.

#### L.3.1 Determination of void ratio at saturation and desiccation limits.

a. The void ratio at the saturation limit,  $e_{SL}$ , can be determined empirically as follows:

$$e_{SL} = \frac{1.8LL G_s}{100} \quad (\text{L-9})$$

where

$e_{SL}$  = void ratio at saturation limit

$LL$  = Atterberg liquid limit of dredged material in percent

$G_s$  = specific gravity at the dredged material

b. The void ratio at the desiccation limit can be determined empirically as:

$$e_{DL} = \frac{1.2PL G_s}{100} \quad (\text{L-10})$$

where

$e_{DL}$  = void ratio of desiccation limit

$PL$  = Atterberg plastic limit of dredged material in percent

### L.3.2 Calculation of desiccation depths.

c. As long as the material remains saturated and the free water table is at the surface, the effects of evaporative drying cannot extend deeper than the intersection of the ordinate denoting  $e_{SL}$  and the ultimate void ratio distribution curve (Figure L-7). Thus, the maximum depth to which first-stage drying can occur is

$$h_{1st} = (\ell - z_{SL}) (1 + e_{SL}) \quad (\text{L-11})$$

where

$h_{1st}$  = maximum depth of first-stage drying

$z_{SL}$  = material coordinate at intersection of  $e_{SL}$  and ultimate void ratio distribution curve

While void ratios lower than  $e_{SL}$  may exist in the dredged material below  $z_{SL}$ , they are due to self-weight consolidation and not surface desiccation during first-stage drying.

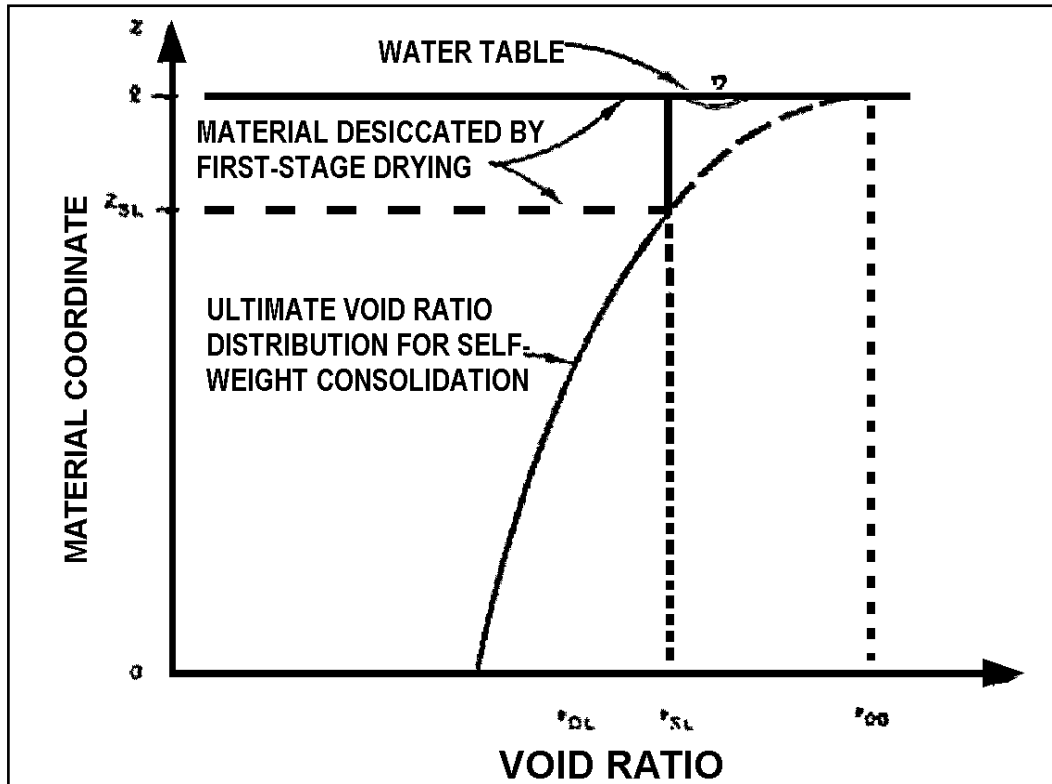

Figure L-7. Maximum Depth of Material Desiccated by First-Stage Drying

d. The absolute maximum depth to which second-stage drying can occur is the water table depth (which sometimes can be measured in the field) or the intersection of the ordinate denoting  $e_{DL}$  with the ultimate void ratio distribution curve that is based on the surcharge induced (Figure L-8). In equation form

$$h_{2nd} = (\ell - z_{DL}) (1 + e_{DL}) \quad (\text{L-12})$$

where

$h_{2nd}$  = maximum depth of second-stage drying

$z_{DL}$  = material coordinate at intersection of  $e_{DL}$  and ultimate void ratio distribution curve

Again it can be seen that void ratios lower than  $e_{DL}$  may exist below  $z_{DL}$  due to consolidation effects. It is also important to note that  $h_{1st}$  can be larger than  $h_{2nd}$  due to the low void ratio of a completely desiccated dredged material. A field indicator of the depth to which second-stage drying can be effective is the depth of cracks in the dredged material. Of course, cracks subjected to periodic rainfall are probably shallower than they would be under constant evaporative conditions.

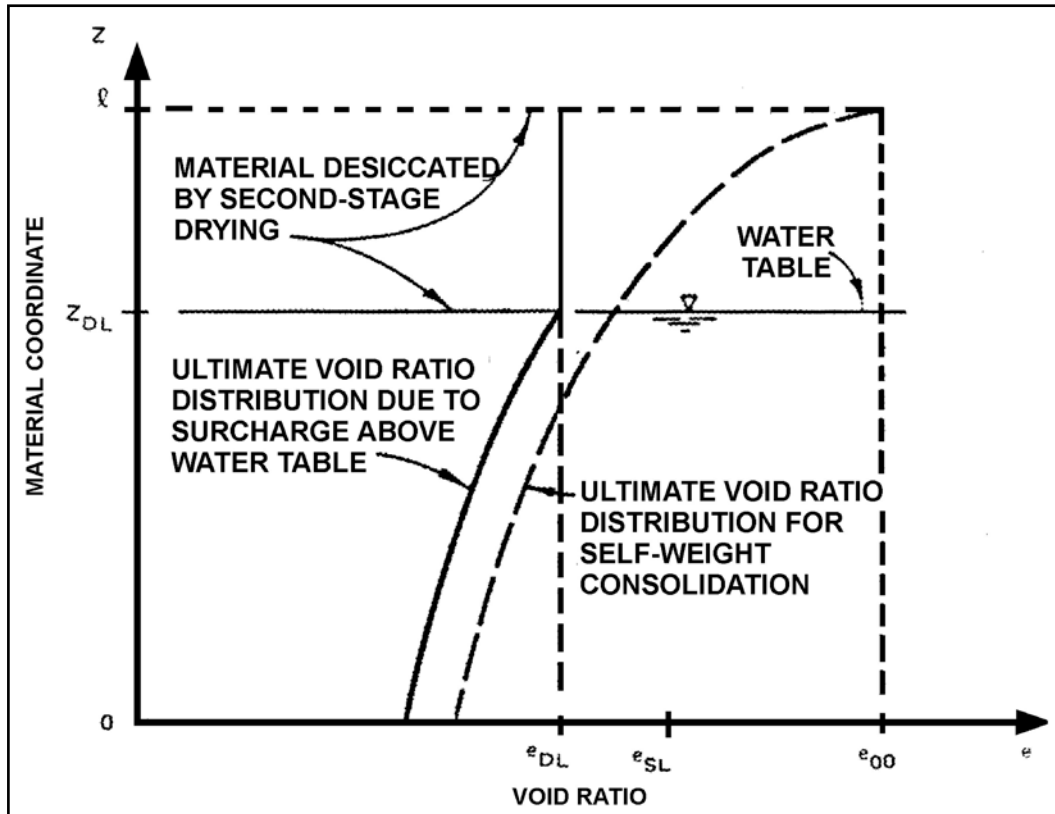

Figure L-8. Maximum Depth of Material Desiccated by Second-Stage Drying

e. The preceding two equations form a rational basis for estimating the depths of crust formation in dredged material under first- and second-stage drying. They should be applicable whenever sufficient dredged material is present to provide an intersection between the ultimate void ratio distribution and the appropriate limiting void ratio, and there is no external influence limiting the water table depth. If insufficient material is present, the entire dredged fill layer may be subjected to first- and second-stage drying processes in turn. If the water table depth is limited, the second-stage drying depth will be similarly limited. Again, the practical maximum depth of second-stage drying is best estimated from the maximum depth of desiccation cracks.

f. The maximum depth of first-stage drying as expressed in Equation L-11 should be a realistic measure for most fine-grained soils whose  $e_{SL}$  intersects the consolidated void ratio curve above the material coordinate defining the soil's maximum field crust thickness. For those soils with an  $e_{SL}$  so low that  $z_{SL}$  is greater than  $z_{DL}$  when based on the preceding considerations, the  $z_{SL}$  should be limited to no greater than  $z_{DL}$ .

L.3.3 Evaporation efficiencies. The expression for defining the drying rate during second-stage evaporation is simply a linear function of the water table depth:

$$C_E = C_E' \left( 1 - \frac{h_{wt}}{H_{2nd}} \right) \text{ for } h_{wt} \leq h_{2nd} \quad (\text{L-13})$$

where

$C_E$  = evaporation efficiency

$C_E'$  = maximum evaporation efficiency for soil type

$h_{wt}$  = depth of water table below surface

$h_{2nd}$  = maximum depth of second-stage drying

L.3.4 Water loss and desiccation settlement.

a. The water lost from a dredged material layer during first-stage drying can be written

$$\Delta W' = CS - C_E' \cdot EP + (1 - C_D) RF \quad (\text{L-14})$$

where

$\Delta W'$  = water lost during first-stage drying

$CS$  = water supplied from lower consolidating material

$EP$  = pan evaporation rate

$C_D$  = drainage efficiency

$RF$  = rainfall

Even though some minor cracks may appear in the surface during this stage, the material will remain saturated, and vertical settlement is expected to correspond with water loss or

$$\delta_D' = \Delta W' \quad (\text{L-15})$$

where  $\delta_D'$  = settlement due to second-stage drying.

b. Water lost during second-stage drying can be written

$$\Delta W'' = CS - C_E' - \frac{h_{wt}}{h_{2nd}} \cdot EP + (1 - C_D) RF \quad (L-16)$$

where

$\Delta W''$  = water lost during second-stage drying.

c. Two things prevent an exact correspondence between water loss and settlement during second-stage drying. First is the appearance of an extensive network of cracks that may encompass up to 20% of the volume of the dried layer. Second is the probable loss of saturation within the dried material itself. Combining these two occurrences into one factor enables the vertical settlement to be written

$$\delta_D'' = \Delta W'' - 1 - \frac{PS}{100} h_{wt} \quad (L-17)$$

where

$\delta_D''$  = settlement due to second-stage drying

$PS$  = gross percent saturation of dried crust that includes cracks

In determining the second-stage drying settlement, there are three unknowns and only two equations. Therefore, hand calculation involves an iterative procedure.

d. The empirical approach as outlined and interaction of consolidation and desiccation are incorporated in the computer solutions described in Appendix F, "Automated Dredging and Disposal Alternatives Modeling System (ADDAMS)." Use of the computer solutions is recommended for evaluation of the long-term storage capacity of confined disposal areas.

#### L.4 Example Consolidation Calculations.

L.4.1 Problem statement. It is required to determine the time rate of surface settlement of a 10.0-foot-thick, fine-grained dredged fill material having a uniform initial void ratio after sedimentation of 7.0. The layer will be deposited on a normally consolidated compressible foundation 10.0 ft thick that overlies an impermeable bedrock. Laboratory oedometer testing of the dredged material resulted in the  $\sigma'$ - $e$  relationship shown in Figure L-1 and  $k(e)$ ,  $c_v(e)$ , and  $g(e)$  relationships as shown in Figure L-10. Laboratory oedometer testing of the foundation material resulted in the relationships shown in Figures L-9 and L-10. Laboratory testing also revealed specific gravity of solids  $G_S = 2.75$  in the dredged material and  $G_S = 2.65$  in the foundation material.

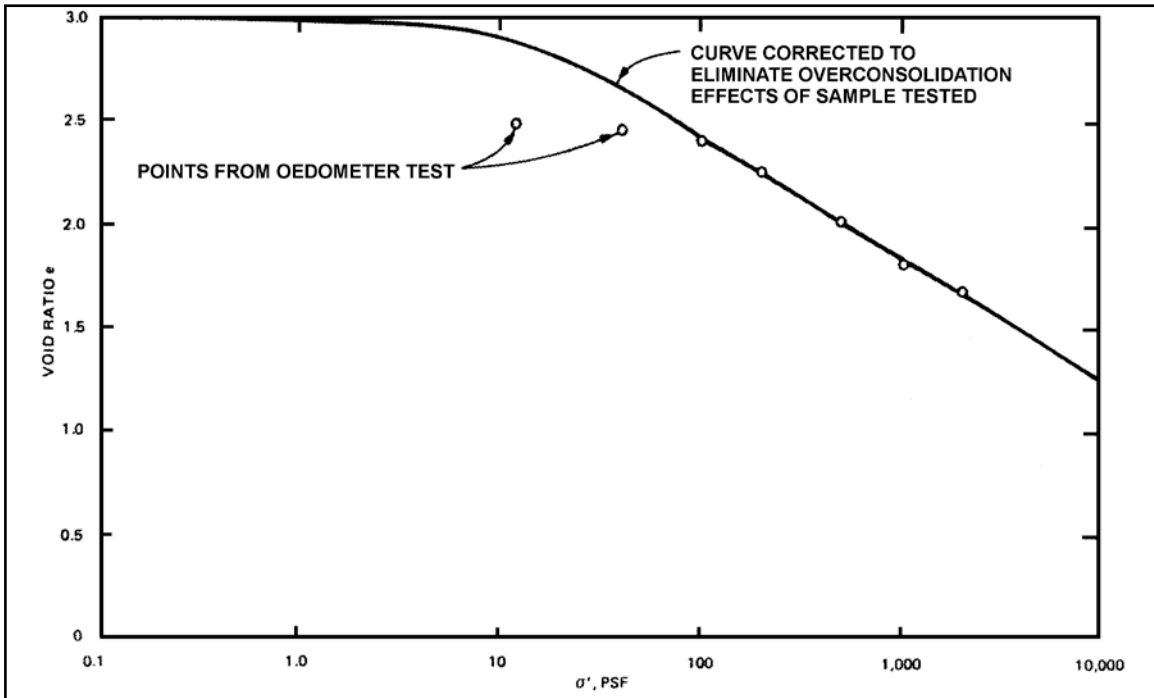

Figure L-9. Relationship Between Void Ratio and Effective Stress,  $e$ -log- $\sigma'$  Curve, for Compressible Foundation for Eedometer Testing

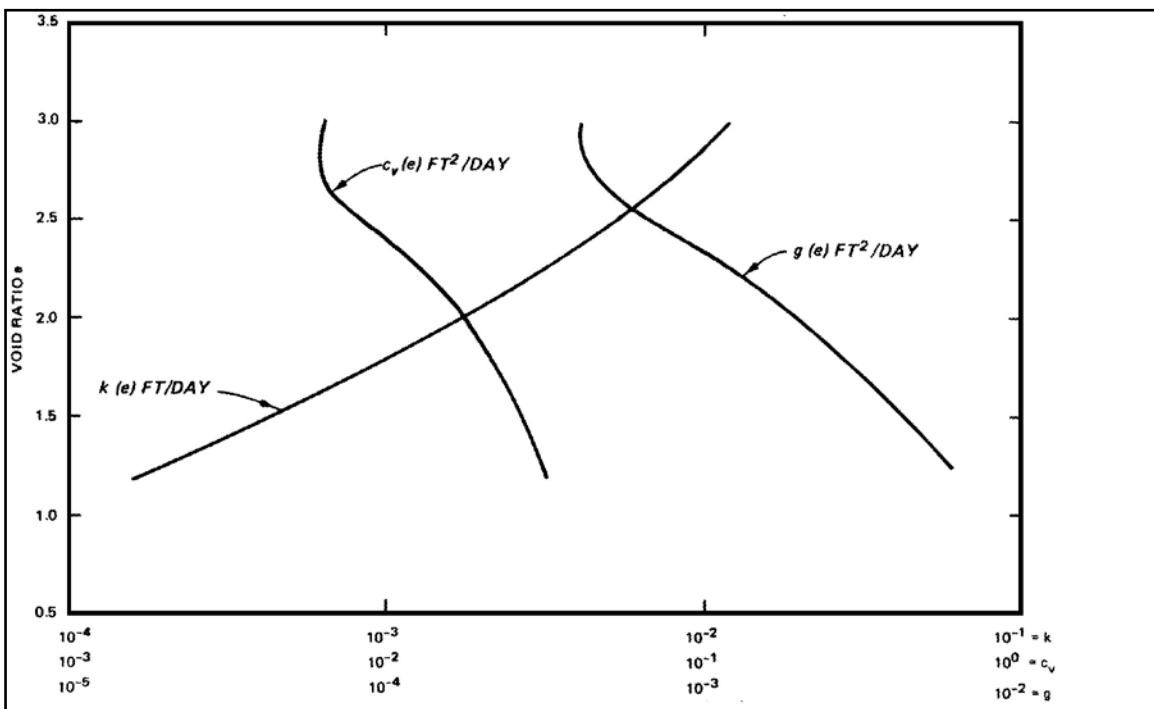

Figure L-10. Permeability and Coefficients of Consolidation as a Function of Void Ratio for a Compressible Foundation



## L.4.2 Void ratio distributions.

a. For the most accurate calculations, it is necessary to know the distribution of void ratios throughout the consolidating layers both before consolidation begins and after it ends. As an aid in this and later calculations, Table L-1 is set up where the layers are subdivided into ten increments each. Entries in the table correspond to average conditions at the center of each sublayer.

Table L-1. Void Ratio Distribution and Ultimate Settlement Calculations<sup>1</sup>

$i$	$h_{i,o}$ , ft	$\ell_i$ , ft	$\sigma'_{i,o}$ , p/ft <sup>2</sup>	$e_{i,o}$	$\sigma'_{i,4}$ , p/ft <sup>2</sup>	$e_{i,\infty}$	$h_{i,\infty}$ , ft	$\delta_{i,\infty}$ , ft
Dredged Fill								
1	1.0	0.125	0.0	7.0	6.8	6.52	0.94	0.06
2	1.0	0.125	0.0	7.0	20.5	5.93	0.87	0.13
3	1.0	0.125	0.0	7.0	34.1	5.57	0.82	0.18
4	1.0	0.125	0.0	7.0	47.8	5.34	0.79	0.21
5	1.0	0.125	0.0	7.0	61.4	5.14	0.77	0.23
6	1.0	0.125	0.0	7.0	75.1	4.98	0.75	0.25
8	1.0	0.125	0.0	7.0	102.4	4.75	0.72	0.28
9	1.0	0.125	0.0	7.0	116.0	4.65	0.71	0.29
10	1.0	0.125	0.0	7.0	129.7	4.57	0.70	0.30
	$\Sigma = 10$	$\Sigma = 1.250$					$\Sigma = 7.80$	$\Sigma = 2.20$
Foundation								
1	1.0	0.259	13.3	2.86	149.8	2.31	0.86	0.14
2	1.0	0.275	40.9	2.64	177.4	2.26	0.90	0.10
3	1.0	0.286	69.7	2.50	206.2	2.23	0.92	0.08
4	1.0	0.293	99.5	2.41	236.0	2.20	0.94	0.06
5	1.0	0.299	130.0	2.35	266.5	2.17	0.95	0.05
6	1.0	0.305	161.1	2.28	297.6	2.14	0.95	0.04
7	1.0	0.308	192.6	2.25	329.1	2.11	0.95	0.04
8	1.0	0.312	224.6	2.21	361.1	2.09	0.96	0.04
9	1.0	0.314	256.8	2.18	393.3	2.07	0.96	0.03
10	1.0	0.317	289.2	2.15	425.7	2.05	0.90	0.03
	$\Sigma = 10$	$\Sigma = 2.968$					$\Sigma = 9.38$	$\Sigma = 0.61$

<sup>1</sup> Symbols are defined in the main text.

b. Completion of the table is a straightforward exercise for the dredged fill layer. The column for  $e_{i,o}$  is given in the problem statement and the initial effective stress  $\sigma'_{i,o}$  will always be zero by definition. The sublayer depth in reduced coordinates is calculated directly from Equation L-2.

$$\ell_i = \frac{h_{i,o}}{1 + e_{i,o}} = \frac{1.0}{1 + 7.0} = 0.125 \text{ ft}$$

The ultimate effective stress  $\sigma'_{i,\infty}$  column is computed from Equation L-5.

Thus

$$\sigma'_{1,\infty} = \frac{1}{2} \ell_1 (\gamma_s - \gamma_w) = \left( \frac{0.125}{2} \right) (2.75 - 1.0) 62.4 = 6.8 \text{ lb/ft}^2$$

and

$$\sigma'_{2,\infty} = \frac{1}{2} \ell_2 (\gamma_s - \gamma_w) + \ell_1 (\gamma_s - \gamma_w) = 20.5 \text{ lb/ft}^2$$

The final void ratio  $e_{i,\infty}$  is read from the laboratory oedometer test curve. The usual  $e$ -log- $\sigma'$  curve is more accurate for this purpose than the curve given in Figure L-3. The final sublayer height  $h_{i,\infty}$  is also calculated by substitution into Equation L-3:

$$h_{1,\infty} = \ell_1 (1 + e_{1,\infty}) = 0.125 (1 + 6.52) = 0.94 \text{ ft}$$

c. Completion of the table for the compressible foundation layer is not quite as simple since the initial void ratio is not usually known. However, it can be calculated given its  $e$ -log- $\sigma'$  curve in the normally consolidated state as shown in Figure L-9. An iterative process is required. First assume an initial void ratio for the first layer,  $e_{1,o}$ . Based on this void ratio, calculate  $\ell$  from Equation L-2. Thus, assuming  $e_{1,o} = 3.0$

$$\ell_i = \frac{h_1}{1 + e_{1,o}} = \frac{1.0}{1 + 3.0} = 0.250 \text{ ft}$$

Using this value of  $\ell_1$ ,  $\sigma'_{1,o}$  is calculated from Equation L-5 as

$$\sigma'_{1,o} = \frac{1}{2} \ell_1 (\gamma_s - \gamma_w) = \left( \frac{0.250}{2} \right) (2.65 - 1.0) 62.4 = 12.9 \text{ lb/ft}^2$$

Based on this value of  $\sigma'_{1,o}$ , a new estimate of  $e_{1,o}$  is made from Figure L-9 and the process is repeated until no further iterations are required. (Usually three iterations are required for an accuracy  $\pm 0.01$  in the void ratio.) Using the total effective weight of the first layer, a first estimate of the void ratio in the second layer is made from Figure L-1 and its true average void ratio is determined as was done with the first sublayer. The first estimate of each following sublayer is based on the effective weight of those above it.

d. Once the initial void ratios and effective stresses have been determined throughout the compressible foundation, the final void ratios and effective stresses are easily found. The final effective stress  $\sigma'_{1,\infty}$  is its initial value plus the effective weight of the dredged fill layer. Thus if

$$\sigma'_{\text{dredged fill}} = \ell_{\text{d.f.}} (\gamma_s - \gamma_w) = 136.5 \text{ lb/ft}^2$$

then

$$\sigma'_{i,\infty} = \sigma'_{i,o} + 136.5$$

for the foundation. The final sublayer void ratio can then be read from the  $e$ -log- $\sigma'$  curve, and the final sublayer height  $h_{i,\infty}$  can be calculated from Equation L-3.

L.4.3 Ultimate settlement. Ultimate settlements for the compressible layers are calculated directly from Equation L-4 or from the difference in the sum of the sublayer heights initially and finally. As shown in Table L-1, for the dredged fill,  $\delta_\infty = 2.20$  ft, and for the foundation,  $\delta_{,\infty} = 0.61$  ft. The fact that ultimate settlement plus total sublayer final heights in the foundation does not equal the initial total sublayer heights is due to round-off errors in the calculations.

#### L.4.4 Settlement as a function of time.

a. A prerequisite to determining settlement as a function of time is the selection of an appropriate coefficient of consolidation during the course of consolidation, and in the case of linear finite strain theory, appropriate values for  $\lambda$  and  $N$ .

b. For the dredged fill layer, a look at Table L-1 shows the void ratio will vary between the extremes 7.00 to 4.57. Figure L-2 is used to determine the appropriate coefficient of consolidation for the average void ratio during consolidation. For the foundation, where the void ratio extremes are 2.86 to 2.05, Figure L-10 is used.

c. The value of  $\lambda$  must be determined by approximating the laboratory-determined curve with one of the forms of Equation L-1. Figure L-11a shows that an appropriate value for the dredged fill is

$$\lambda = 0.026 \frac{\text{ft}^3}{\text{lb}}$$

and Figure L-11b shows that an appropriate value for the foundation is

$$\lambda = 0.009 \frac{\text{ft}^3}{\text{lb}}$$

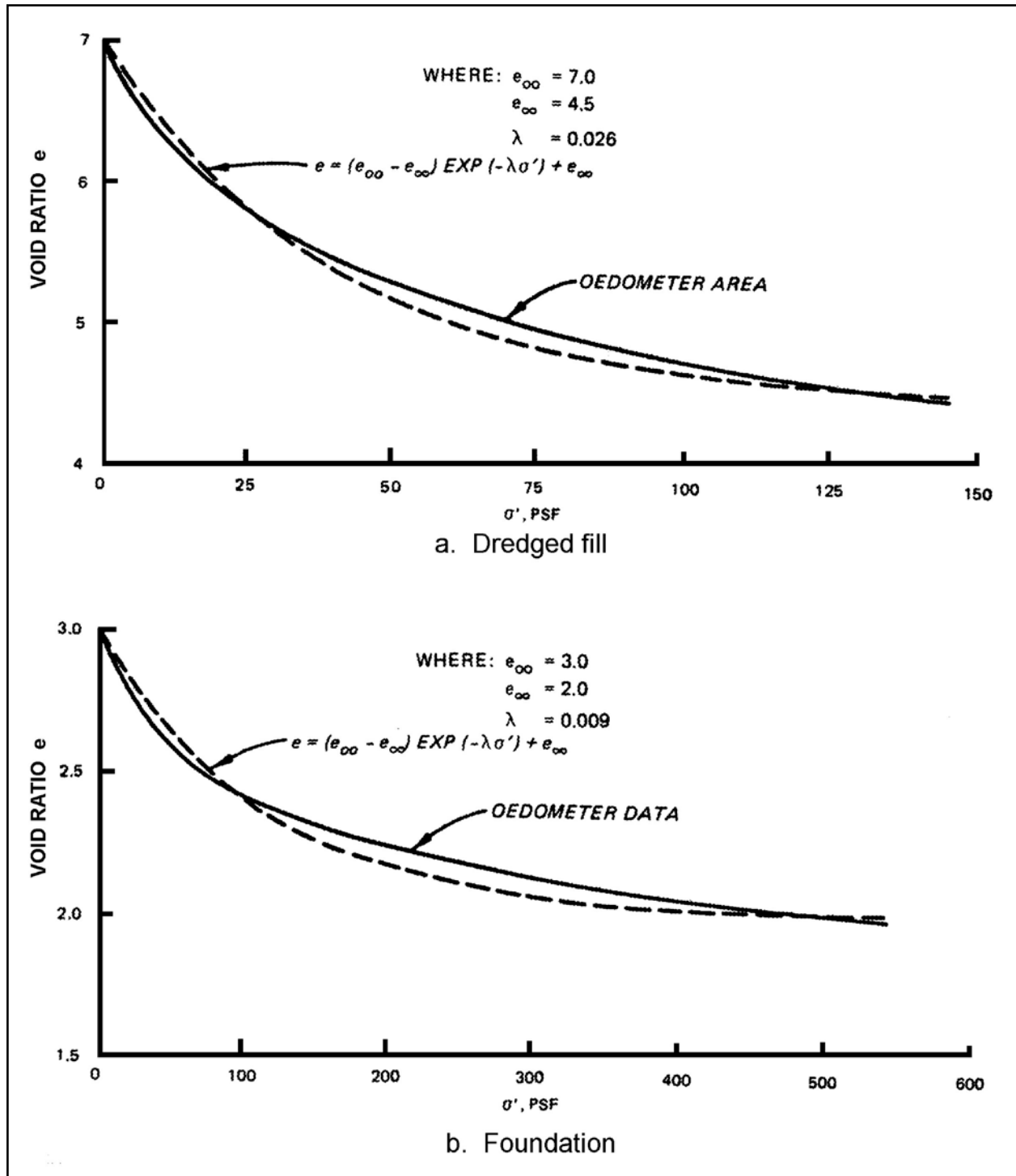

Figure L-11. Exponential Void Ratio-Effective Stress Relationship Fitted to Oedometer Data

These curves were fitted in the range of expected void ratios only and should not be used in computations outside those ranges.

d. All that remains is to calculate the dimensionless time factor from Equation L-6 where  $H = 10.0$  ft initially for both layers with appropriate constants. By small strain theory, Figure L-12 is used to determine percent consolidation. Curve Type I is used for the foundation and Type III for the dredged fill. By linear finite strain theory, Figure L-3 is used for the foundation and Figure L-5 for the dredged fill. The calculations are organized in Table L-2, and the results are plotted in Figures L-13 and L-14.

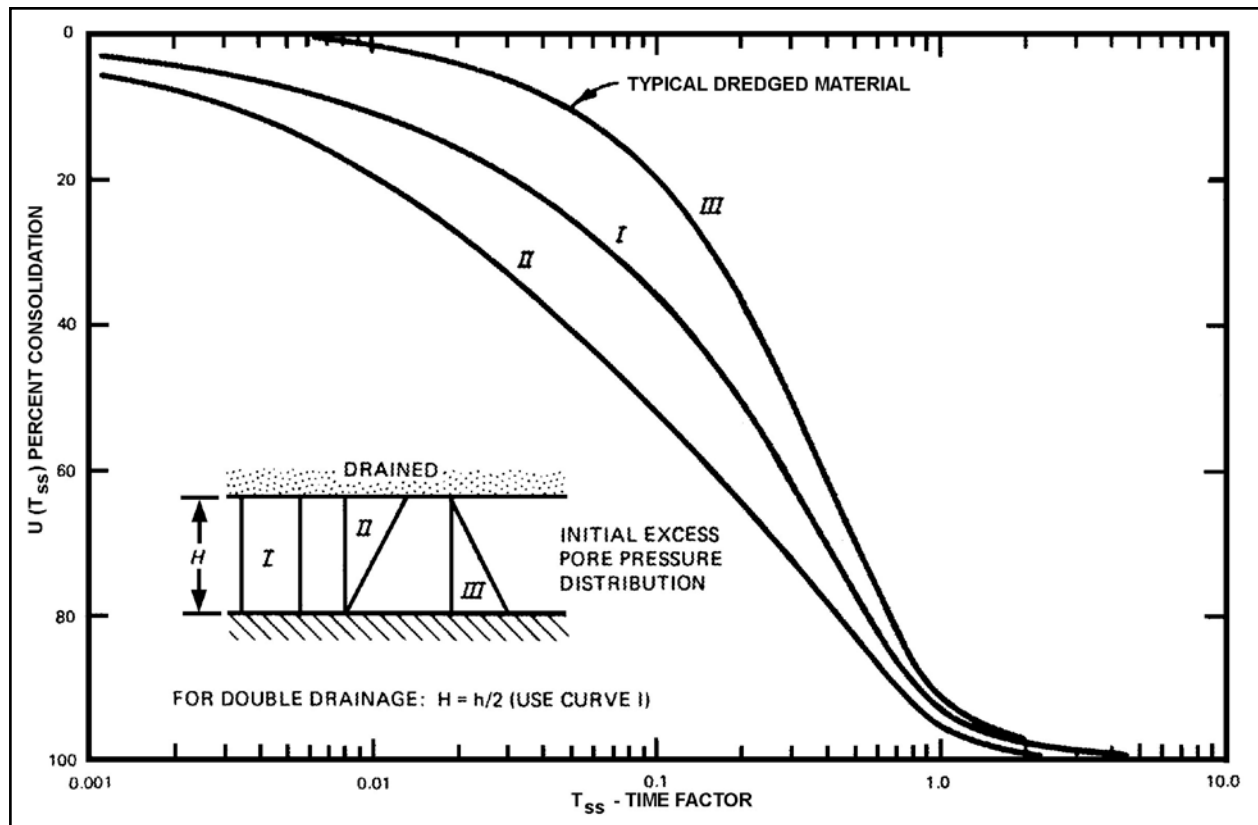

Figure L-12. Degree of Consolidation as a Function of the Time Factor for Various Initial Conditions by Small Strain Theory

Table L-2. Percent Consolidation and Settlement Calculations

$t$ , days	$\bar{e}$	$\bar{H}$ , ft	$c_v$ , ft <sup>2</sup> /day	Small Strain Theory						Linear Finite Strain Theory		
				T	U, %	$\delta$ , ft	$\bar{e}$	$\bar{H}$ , ft	$g$ , ft <sup>2</sup> /day	T	U, %	$\delta$ , ft
Dredged Fill												
500	6.8	9.75	$1.25 \times 10^{-2}$	0.066	14	0.31	6.4	9.25	$2.16 \times 10^{-4}$	0.069	33	0.73
1,000	6.5	9.38	$1.20 \times 10^{-2}$	0.136	26	0.57	5.9	8.63	$2.41 \times 10^{-4}$	0.154	64	1.41
1,500	6.3	9.13	$1.17 \times 10^{-2}$	0.211	39	0.86	5.5	8.13	$2.73 \times 10^{-4}$	0.262	85	1.87
2,000	6.1	8.88	$1.15 \times 10^{-2}$	0.292	50	1.10	5.3	7.87	$2.96 \times 10^{-4}$	0.379	94	2.07
2,500	5.9	8.63	$1.14 \times 10^{-2}$	0.383	60	1.32	5.3	7.87	$2.96 \times 10^{-4}$	0.474	97	2.13
3,000	5.8	8.50	$1.13 \times 10^{-2}$	0.469	68	1.50	5.3	7.87	$2.96 \times 10^{-4}$	0.57	99	2.18
3,500	5.7	8.38	$1.13 \times 10^{-2}$	0.56	74	1.63	5.3	7.87	$2.96 \times 10^{-4}$	0.66	100	2.20
4,000	5.6	8.25	$1.13 \times 10^{-2}$	0.66	80	1.76					100	2.20
4,500	5.5	8.13	$1.13 \times 10^{-2}$	0.77	85	1.87					100	2.20
5,000	5.4	8.00	$1.14 \times 10^{-2}$	0.89	89	1.96					100	2.20
Foundation												
500	2.30	9.79	$1.15 \times 10^{-2}$	0.060	28	0.17	2.25	9.65	$1.19 \times 10^{-3}$	0.068	62	0.38
1,000	2.30	9.79	$1.15 \times 10^{-2}$	0.120	40	0.24	2.20	9.50	$1.30 \times 10^{-3}$	0.148	78	0.48
1,500	2.25	9.65	$1.24 \times 10^{-2}$	0.200	51	0.31	2.20	9.50	$1.30 \times 10^{-3}$	0.221	87	0.53
2,000	2.25	9.65	$1.24 \times 10^{-2}$	0.266	58	0.35	2.15	9.35	$1.45 \times 10^{-3}$	0.329	93	0.57
2,500	2.25	0.65	$1.24 \times 10^{-2}$	0.333	65	0.40	2.15	9.35	$1.45 \times 10^{-3}$	0.412	96	0.59
3,000	2.20	9.50	$1.32 \times 10^{-2}$	0.439	73	0.45	2.15	9.35	$1.45 \times 10^{-3}$	0.494	98	0.60
3,500	2.20	9.50	$1.32 \times 10^{-2}$	0.51	77	0.47	2.15	9.35	$1.45 \times 10^{-3}$	0.58	99	0.60
4,000	2.20	9.50	$1.32 \times 10^{-2}$	0.59	81	0.49	2.15	9.35	$1.45 \times 10^{-3}$	0.66	100	0.61
4,500	2.20	9.50	$1.32 \times 10^{-2}$	0.66	84	0.51					100	0.61
5,000	2.20	9.50	$1.32 \times 10^{-2}$	0.73	87	0.53					100	0.61

Note: Dredged material:  $\delta_{\infty} = 2.20$  ft;  $N = 3.55$ ; Foundation:  $\delta_{\infty} = 0.61$  ft;  $N = 2.75$

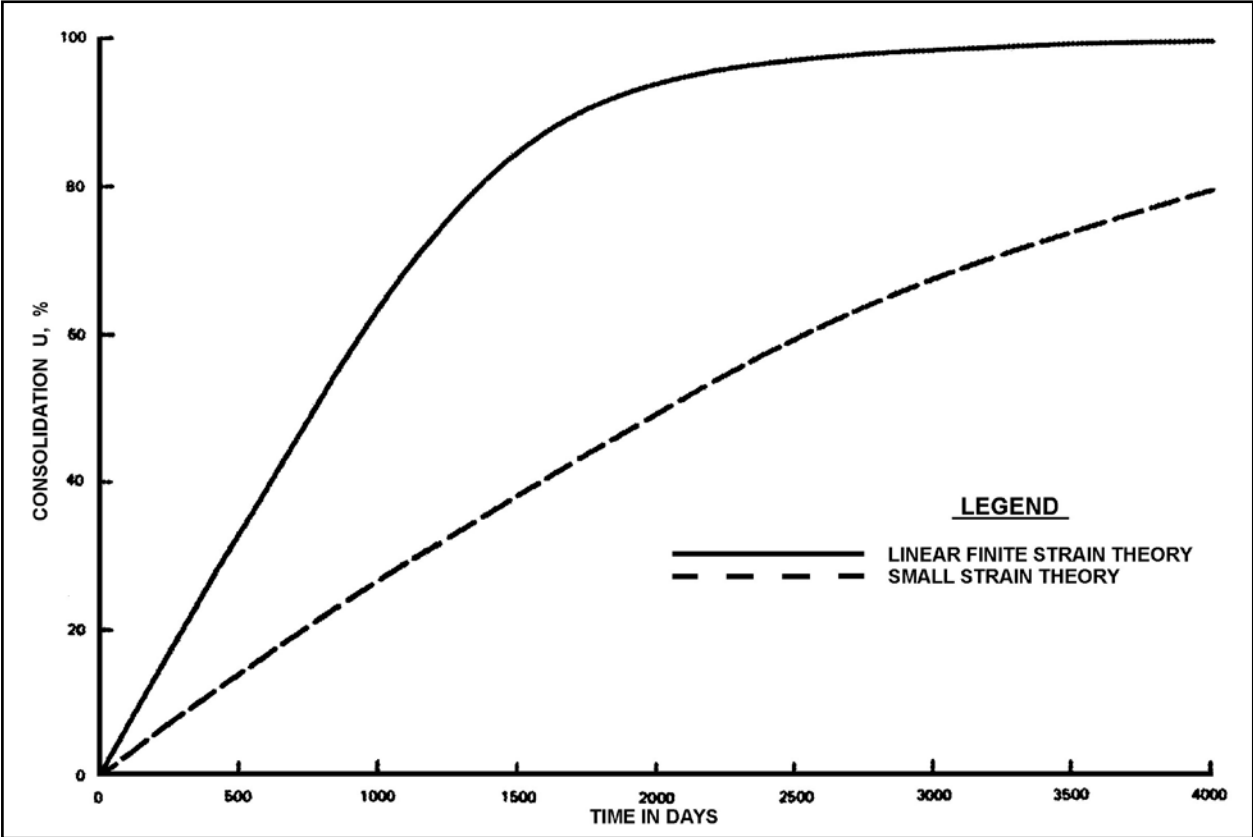

Figure L-13. Comparison of Consolidation Percentages in the Dredged Fill Layer as a Function of Time

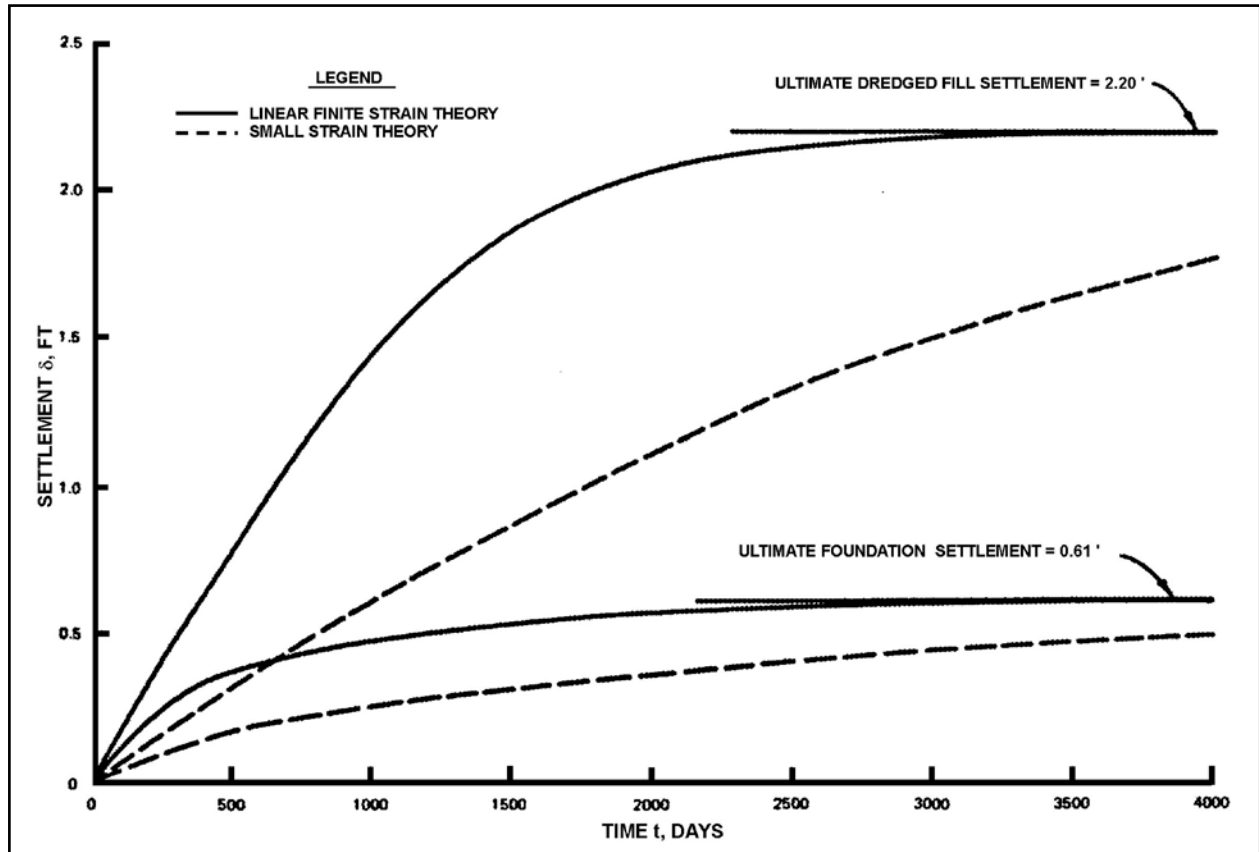

Figure L-14. Comparison of Settlement Predictions by Small Strain and Linear Finite Strain Theories



## APPENDIX M

## Procedures and Example Calculations for Design of a Chemical Clarification System

M.1 Design Procedures.

## M.1.1 Polymer feed system.

M.1.1.1 This design assumes that a low- to medium-viscosity liquid polymer is being used to minimize handling, pumping, and dilution problems. In most cases, the simplest system (shown in Figure M-1) is adequate. Polymer manufacturers should be able to inform the designer if this system is adequate. The experiments on polymer feed concentrations and aging should also indicate its adequacy. If the viscosity of the polymer is high or if low polymer feed concentrations are needed, systems like those shown in Figures M-2 and M-3 should be used. If the polymer requires aging prior to being fed, the two-tank system should be used. These systems are suitable for all but the smallest projects. Polymers requiring predilution should be avoided in systems like those in Figures M-2 and M-3 because they increase the equipment and operating labor requirements.

M.1.1.2 The polymer can be stored at the site in the delivery containers, either 55-gal drums or bulk shipping tanks. The polymer can be fed directly from these containers or transferred to a polymer feed tank. Provisions should be made to guard against freezing. The feed tank may need to be heated or stored in a heated shelter to lower the viscosity and facilitate pumping on cold days. The size of the feed tanks and storage facilities is project dependent.

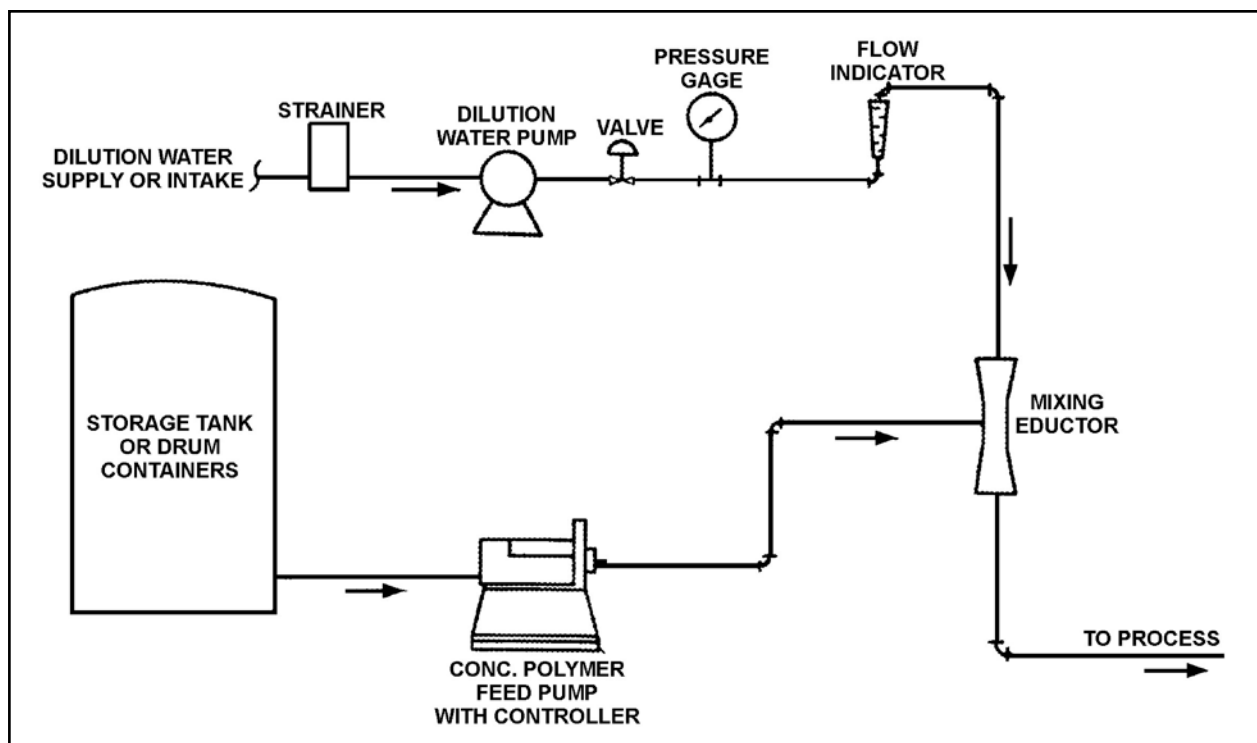

Figure M-1. Schematic of a Simple Liquid Polymer Feed System

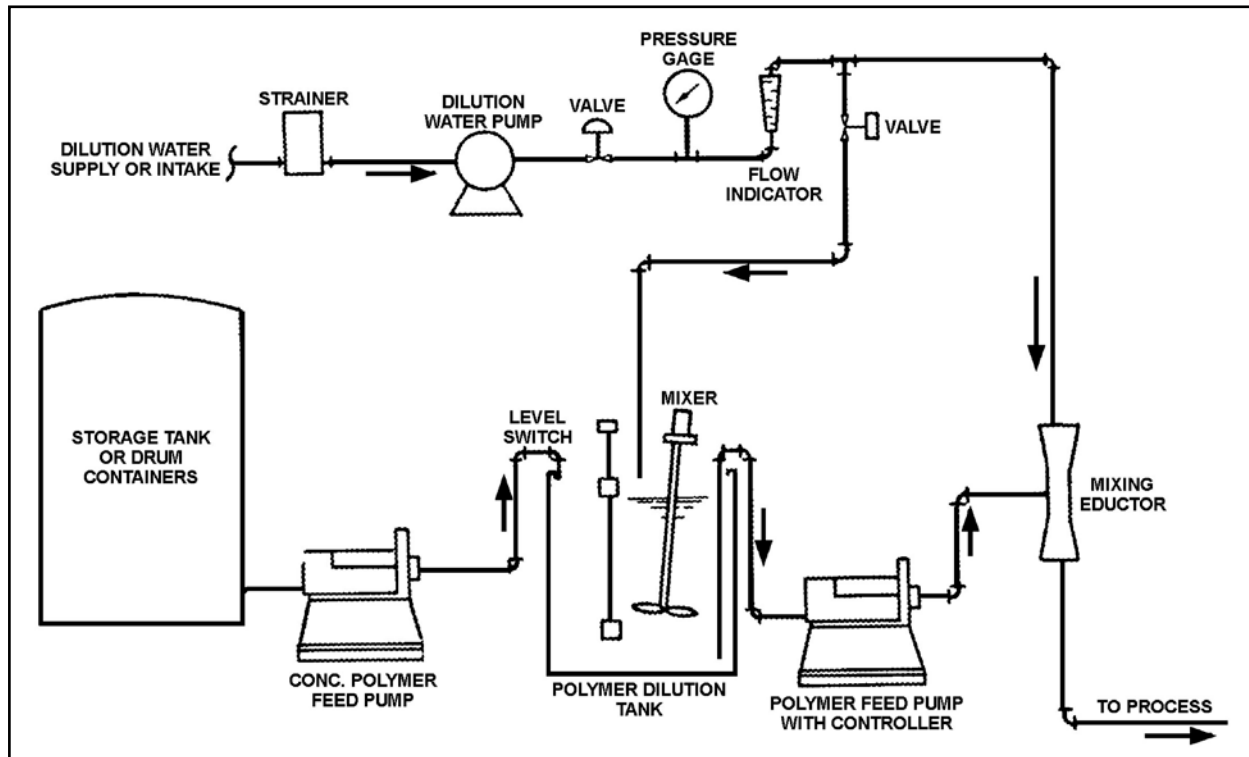

Figure M-2. Schematic of a Single-Tank Liquid Polymer Feed System

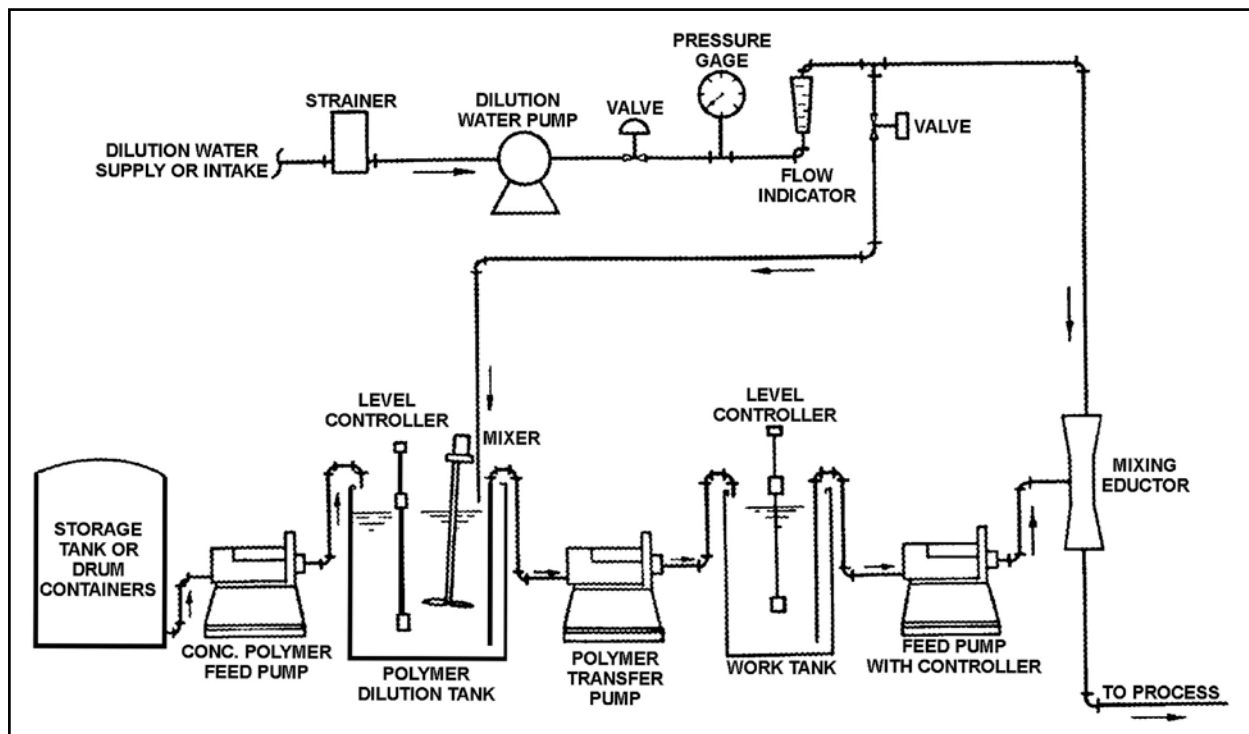

Figure M-3. Schematic of a Two-Tank Liquid Polymer Feed System

M.1.1.3 The volume of polymer required for the project is calculated as follows:

$$\begin{aligned} \text{total volume of inflow, L} &= (\text{volume to be dredged, yd}^3) \\ &\times (\text{in situ sediment conc., g/L}) \\ &\times 764.4 \text{ L/yd}^3 \\ &\div (\text{dredged material slurry conc., g/L}) \end{aligned} \quad (\text{M-1})$$

$$\begin{aligned} \text{total volume of settled material, L} &= (\text{total volume of inflow, L}) \\ &\times (\text{influent slurry conc., g/L}) \\ &\div (\text{conc. of settled material, g/L}) \end{aligned} \quad (\text{M-2})$$

If the concentration of settled material is unknown, it is generally conservative to let

$$\begin{aligned} \text{total volume of settled material, L} &= 2 \times (\text{volume to be dredged, yd}^3) \\ &\times 764.4 \text{ L/yd}^3 \end{aligned} \quad (\text{M-3})$$

Then,

$$\begin{aligned} \text{total volume to be treated, L} &= (\text{total volume of inflow, L}) \\ &- (\text{total volume of settled material, L}) \end{aligned} \quad (\text{M-4})$$

$$\begin{aligned} \text{total volume of polymer required, gal} &= (\text{required dosage, mg/L}) \\ &\times (\text{total volume to be treated, L}) \\ &\div (\text{specific weight of polymer, kg/L}) \\ &\div 106 \text{ mg/kg} \div 3.785 \text{ L/gal} \end{aligned} \quad (\text{M-5})$$

$$\begin{aligned} \text{total poundage of polymer, lb} &= (\text{total volume of polymer, gal}) \\ &\times 3.785 \text{ L/gal} \\ &\times (\text{specific weight of polymer, kg/L}) \\ &\times 2.205 \text{ lb/kg} \end{aligned} \quad (\text{M-6})$$

M.1.1.4 Concentrated polymer solutions should be fed using a positive displacement pump. The pump speed should be regulated by either a manual or automatic controller, and the pump should be capable of discharging a wide range of flows to handle the possible range of required polymer dosages and flow rates of water to be treated. The pump capacity should be at least twice the maximum anticipated polymer feed rate or four times the average feed rate. The minimum pumping rate must be less than 10% of the average anticipated polymer feed rate to handle low flow conditions. The average polymer feed rate is

31 Jul 15

$$\begin{aligned}
 \text{avg. feed rate, mL/sec} &= (\text{avg. flow rate, ft}^2/\text{sec}) \\
 &\quad \times (\text{avg. required dosage, mg/L}) \times 28.31 \text{ L/ft}^3 \\
 &\quad \div (\text{specific weight of polymer, g/mL}) \\
 &\quad \div 1,000 \text{ mg/g}
 \end{aligned}
 \tag{4-30}$$

The polymer pump flow capabilities should range from about

$$\text{pump range, mL/sec} = (0.1 \text{ to } 4) \times (\text{avg. feed rate, mL/sec})
 \tag{M-7}$$

Two polymer pumps operated in parallel may be required to provide the desired range of feed rates.

M.1.1.5 If the polymer requires a tank for predilution, as in Figures M-2 and M-3, it should be diluted by a factor of 10 or 20 in the tank. The polymer feed rate would then increase by this same factor.

M.1.1.6 The polymer feed tanks and dilution tanks should be large enough to feed polymer for 1-2 days under average conditions. The average daily concentrated polymer feed volume is

$$\text{daily volume, gal/day} = (\text{avg. feed rate, mL/sec}) \times 86,400 \text{ sec/day} \div 3,785 \text{ mL/gal}
 \tag{M-8}$$

M.1.1.7 The polymer must be diluted to aid feeding and dispersion. The amount of dilution required can be determined from the manufacturer or experimentally. As a practical limitation, the dilution factor should not exceed 200 under average conditions due to excessive requirements for water at higher dilutions.

M.1.1.8 Supernatant from the containment area, preferably treated supernatant from the secondary cell, can be used for dilution water. However, if the polymer is to be prediluted in a tank, water of good quality should be used to minimize deposition of material in the tank and to maintain the effectiveness of the polymer. The dilution water can be collected from a screened intake suspended near the surface at a place free of debris, resuspended material, and settled material.

M.1.1.9 The dilution water may be pumped by any water pump. The pump capacity should be about 200 times the average polymer feed rate of concentrated polymer. A controller is not needed to regulate the dilution water flow rate since maximizing the dilution aids in dispersion. The polymer and dilution water may be mixed in-line using a mixing eductor.

M.1.1.10 Any injection system can be used as long as it distributes the polymer uniformly throughout the water to be treated. It may consist of a single nozzle or a perforated diffuser pipe running along the weir crest. The system should be as maintenance-free as possible. Fine spray nozzles should be avoided because suspended material from the dilution water may clog them.

M.1.1.11 The feed lines may be constructed of rubber hoses or PVC pipe. They must be designed to carry the design flows of the viscous polymer solution at low temperatures. Provisions must be made to prevent freezing, particularly when the system is not operating.

M.1.2 Mixing system. The weir box and discharge culvert(s) should, if possible, be designed to provide adequate mixing. A 2-ft drop between the water surface of the first basin and the second basin is sufficient energy for mixing if efficiently used. Mechanical mixers should be considered if sufficient energy is unavailable. The design of mechanical mixing systems has been presented in Jones, Williams, and Moore (1978) and, therefore, is not be duplicated here.

M.1.2.1 Weir. The weir should be designed to collect supernatant from the primary containment area and to disperse the polymer thoroughly. The weir box does not provide efficient mixing, and, therefore, it is undesirable to lose all the energy of the water by a free fall into the weir box. The system should provide a small drop into the weir box and high head loss through the discharge culvert(s) between the primary and secondary containment areas.

a. The weir box should be designed to prevent leakage; the bottom of the box should be sealed. To minimize leakage, only one section of the box needs to be adjustable to the bottom of the box. Weir boards with tongue and groove joints also decrease leakage. The weir box should be submersible without the weir boards floating from their positions, and all sections of the weir should be level and at the same elevation. An example is shown in Figure M-4.

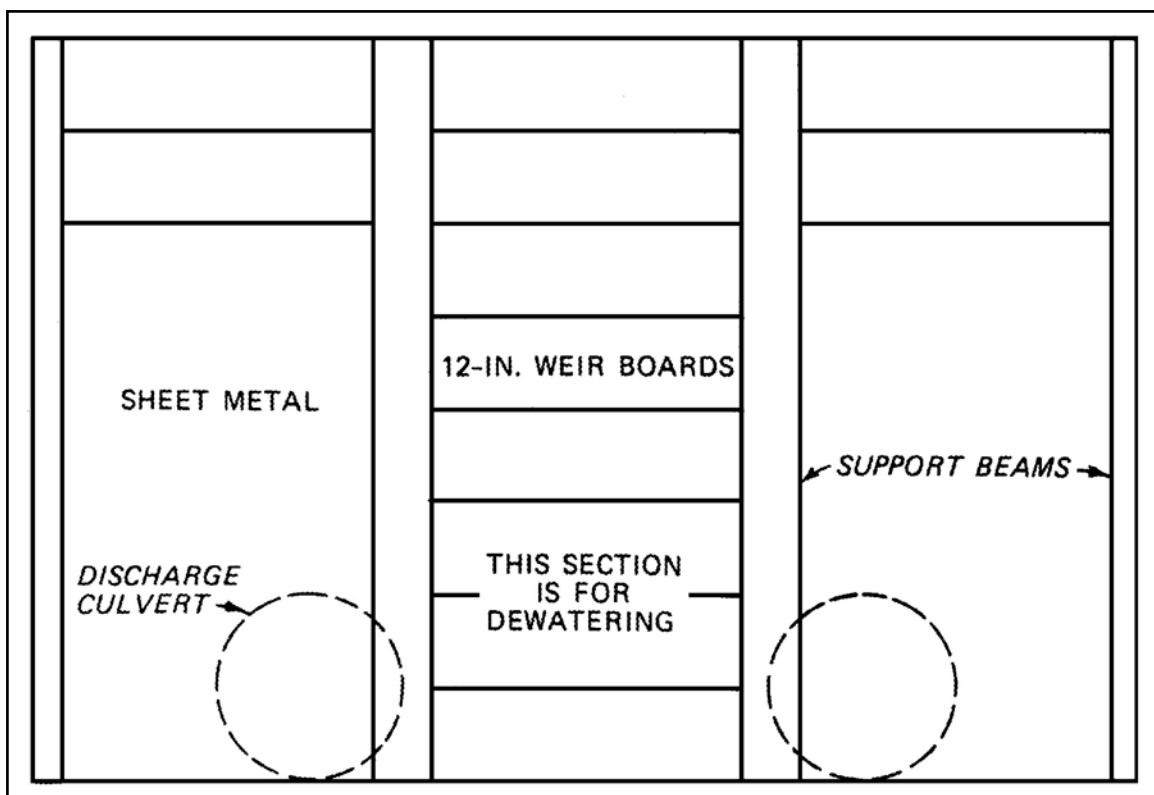

Figure M-4. Frontal View of a Weir

b. The height of the weir crest should be adjustable, so the flow can be stopped when it is too low to treat or so it can be maintained in order to keep treating it when the dredge has stopped. The depth of flow over the weir must be controlled by increments of 1-2 in. to maintain a fairly constant flow rate. The weir must also be able to stop the flow when the treatment system is down for maintenance or repair. The simplest mode of operation is to stop the flow over the weir by adding weir boards when the flow rate is low and then to remove the added weir boards and resume operation after the elevation of the water surface returns to its height at average flow.

M.1.2.2 Discharge culvert. Discharge culverts must be designed to provide the required mixing and to discharge the design flow rate safely. The design procedure presented here determines the length, diameter, and number of culverts that maximize mixing within the constraints of most projects. Frictional head loss provides the mixing and increases with increasing culvert length and decreasing diameter. Multiple culverts increase the duration of mixing but decrease its intensity. Static mixers may be used in-line to increase the head loss of a culvert without increasing its length or decreasing its diameter. The use and design of static mixers is not discussed here, but information on their use is available from their manufacturers.

a. The design approach is to size culverts for the maximum flow rate and the minimum available head and then to calculate the available mixing under average flow conditions. The maximum flow rate is assumed to be the average dredge flow rate with continuous, 24-hr/day production. The designer should also consider other possible sources of inflow. The average flow at the weir is assumed to be the product of average dredge flow rate and fractional production time ratio (generally about 0.75 or 18 hr/day). In this manner, culverts will be able to discharge the design flow safely. It is important to estimate the flow rates fairly accurately in order to properly size culverts. Undersizing can result in overtopping the dikes or in forcing the dredge to operate intermittently, and oversizing can result in inadequate mixing. The amount of mixing can be compared with the mixing requirements determined experimentally to evaluate the design. If the amount of mixing is inadequate, the designer may want to change the containment area design to provide a greater head for mixing. The required head can be determined using the design equations.

b. The design procedure is as follows (Figure M-5 presents an example weir mixing system). Assume that the maximum flow rate is the average dredge flow rate with continuous production, 24 hr/day. Also assume a 0.5-ft drop into the weir box under maximum flow. Then determine the difference in elevation ( $\Delta h$ ), in feet, between the water surface of the basins at their highest operating levels from the design. Let  $H$ , in feet, =  $\Delta h - 0.5$  where  $H$  is the maximum permissible head loss through the culvert at maximum flow. Assuming a submerged inlet and outlet and a corrugated metal culvert (though less head loss and better mixing for low flows would be realized if the outlet were not submerged), then

$$H = \left( 1.5 + \frac{Lf}{D} \right) \frac{v^2}{2g} \quad (\text{M-9})$$

where

$f$  = friction factor

$D$  = culvert diameter, ft

Select the range of culvert lengths from containment area layouts.

$$H = \left( 1.5 + \frac{185(0.025)^2 L}{D^{4/3}} \right) \frac{8Q^2}{g\pi^2 N_c^2 D^4} \quad (\text{M-10})$$

where

$Q$  = maximum flow rate, ft<sup>3</sup>/sec

$N_c$  = number of parallel culverts

Rearranging the above equation gives

$$D = \left( \frac{8Q^2 1.5 D^{4/3} + 185(0.025)^2 L}{g\pi^2 H N^2} \right)^{3/16} \quad (\text{M-11})$$

This equation converges to the minimum diameter in three or four iterations by using 2 ft for the initial  $D$  and then substituting the calculated  $D$  for the next iteration. Solve the above equation using the minimum and maximum culvert length based on the containment area layout for up to five culverts. For each number of culverts, choose the largest commercially available diameter between the calculated diameters for the minimum and maximum culvert lengths. If there are not any commercial sizes between these diameters, select the next larger commercial size and the maximum length. Calculate the culvert length for the selected commercial sizes.

$$L = \left( \frac{g\pi^2 H N^2 D^4}{8Q^2} - 1.5 \right) \left( \frac{D^{4/3}}{185(0.025)^2} \right) \quad (\text{M-12})$$

Calculate  $\bar{v}$  and  $f$  for the selected sizes at average flow.

$$\bar{v} = 4\bar{Q} / \pi D^2 \quad (\text{M-13})$$

$$f = \frac{185(0.025)^2}{D^{1/3}}$$

31 Jul 15

where

 $\bar{v}$  = mean velocity at average flow, ft/sec $\bar{Q}$  = average flow rate, ft<sup>3</sup>/sec $f$  = friction factorCalculate the mixing  $Gt$  of each design at average flow.

$$Gt = \sqrt{\frac{\gamma_s f \bar{v} L^2}{2G\mu_s D}} \quad (\text{M-14})$$

where

 $Gt$  = mixing effort $\gamma_s$  = specific weight, 62.4 lb/ft<sup>3</sup> $\mu_s$  = absolute viscosity,  $2.36 \times 10^{-5}$  lb/sec/ft<sup>2</sup>

Calculate the head loss at average flow and the maximum carrying capacity of the culvert at a head of  $Dh$  to determine the limits of the design. Select the best overall design based on mixing, cost, operating flexibility, and so on.

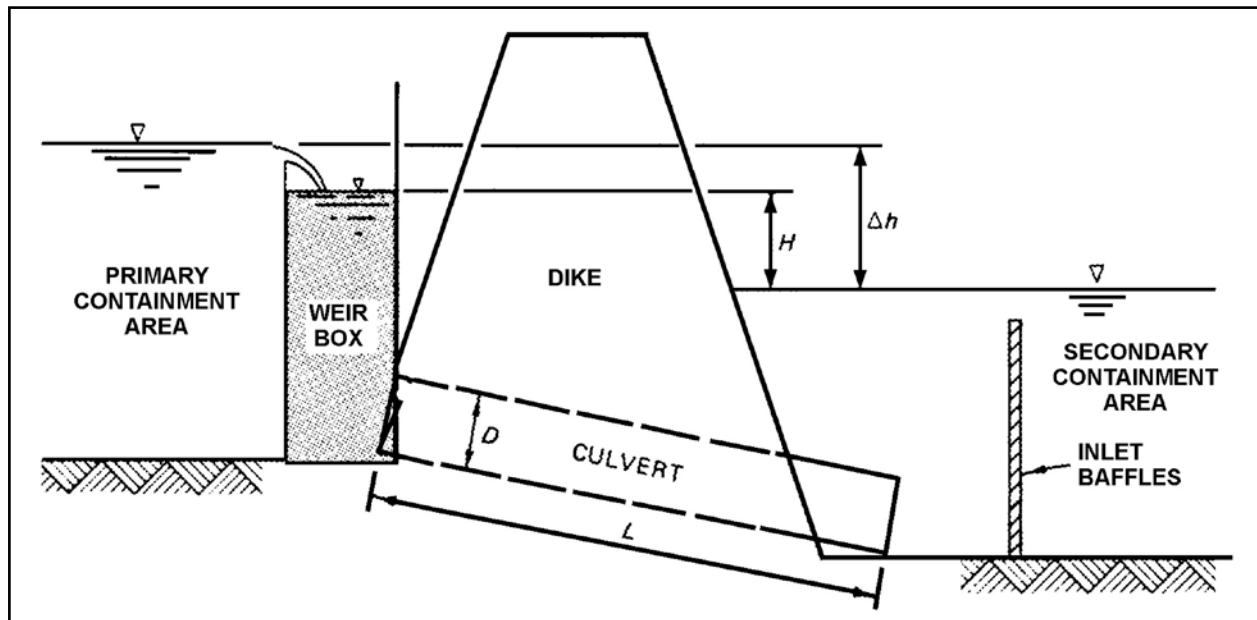

Figure M-5. Example Weir Mixing System



### M.1.3 Secondary containment area.

M.1.3.1 Design approach. The secondary area must be designed to provide adequate residence time for good settling and sufficient volume for storage of settled material. The total volume of the cell is the sum of the ponded volume and storage volume. The required ponded volume is a function of the hydraulic efficiency of the cell and the flow rate. The storage volume depends on the solids concentration entering the basin, the depth of the cell, the total volume to be treated, the flow rate, and the mud pumping schedule.

M.1.3.2 Ponded volume. Effective settling requires a ponded depth of 2-3 ft and a minimum of 20 min of detention. Due to short-circuiting, the mean residence time should be at least 60 min and the theoretical residence time of the ponded volume should be at least 150 min. The shape of the cell should have a length-to-width ratio of at least 3:1 to reduce short-circuiting.

M.1.3.3 Storage volume. The settling properties of flocculated dredged material resulting from chemical clarifications have not been well defined. Solids concentration or density profiles have been measured at only one field site. The settled material was very fluid and, as such, did not clog the inlet culvert, even though settled material accumulated near the inlet to a depth 1 ft higher than the top of the culvert. The kinetic energy of the inflow was capable of keeping the inlet clear of material. Resuspended material settled rapidly in the basin. The concentration of settled material at the interface between the supernatant and settled layer was 50 g/L, and the concentration increased with increasing depth at a rate of 25 g/L/ft. Therefore, deeper basins stored more material in a given volume due to compaction. The concentration of the material increased rapidly upon dewatering.

M.1.3.4 Storage requirements estimation. Knowing the average available depth of the secondary basin, the total storage requirements can be estimated as follows:

- a. The total mass of material to be stored or pumped from the secondary area ( $M$ ) is

$$M, g = (\text{primary effluent conc.} - \text{secondary effluent conc.}, g/L) \times (\text{volume to be treated}, L) \quad (M-15)$$

- b. The average concentration of settled material ( $C_s$ ) is

$$C_s, g/L = [2 \times 50 g/L + 25 g/L - ft \times (\text{average depth of storage}, ft)] \div 2 \quad (M-16)$$

- c. Total volume of settled treated material ( $V_s$ ) is

$$V_s, L = (M, g) \div (C_s, g/L) \quad (M-17)$$

$$V_s, ft^3 = (V_s, L) \div 28.32 L/ft^3$$

31 Jul 15

d. The maximum area required ( $A_s$ ) is

$$\begin{aligned}
 A_s, \text{ acre} &= (V_s, \text{ ft}^3) \\
 &\div (\text{average depth of storage, ft}) \\
 &\div 43,560 \text{ ft}^2/\text{acre} \quad (4.42)
 \end{aligned}
 \tag{M-17b}$$

M.1.3.5 Poned area. The required area and volume for ponding ( $A_p$  and  $V_p$ , respectively) is

$$A_p = V_p \div (\text{average depth of ponding, ft}) \tag{M-18}$$

$$V_p = (\text{average flow rate, ft}^2/\text{sec}) \times 9,000 \text{ sec} \tag{M-19}$$

M.1.3.6 Design area. The containment area should be designed to have a total depth of the sum of the ponded depth and the depth of storage. The area of the cell should be the larger of the areas required for ponding and for storage. If the area required for storage is greater than the area required for ponding, the depth of ponding can be reduced to a minimum depth of 2-3 ft, thereby increasing the available depth of storage. If the area for storage is still greater, the only way to reduce the area requirements further would be to decrease the required storage volume by transferring settled treated material from the basin to the primary containment area. In the overall basin design, it is important to use the greatest practical depth and to optimize its use to provide good mixing through the discharge culvert, ponding for good settling, and storage for treated material. To minimize the size of the secondary area and to maximize the energy available for mixing, the secondary area should be used only for temporary storage, except for small one-time projects. Therefore, the settled treated material should be regularly removed from the basin. This approach would also facilitate dewatering and recurring use of the area for chemical treatment.

M.1.3.7 Mud pumping. If the settled material is to be pumped, the required pumping rate would be

$$\begin{aligned}
 \text{mass pumping rate, g/day} &= (\text{influent conc., g/L} - \text{effluent conc., g/L}) \\
 &\times (\text{average flow rate, ft}^2/\text{sec}) \times 28.31 \text{ L/ft}^3 \\
 &\times (\text{seconds of production per day})
 \end{aligned}
 \tag{M-20}$$

$$\begin{aligned}
 \text{volumetric pumping rate, ft}^3/\text{day} &= (\text{mass pumping rate, g/day}) \\
 &\div [2 \times 50 \text{ g/L} + 25 \text{ g/L} - \text{ft} \\
 &\times (\text{average depth of storage, ft})] \times 2
 \end{aligned}
 \tag{M-21}$$

M.1.3.8 Inlet baffles. The inlet hydraulics of the secondary area can have a significant effect on settling performance. Inlet baffles can reduce the effects of short-circuiting and turbulent flow and assist in distributing the flow laterally. The baffles should be placed about one culvert diameter directly in front of the inlet. The baffle should be at least two diameters wide and may be either slotted or solid. Slotted baffles are better and may be made of 4 in. x 4-in. wooden posts

spaced several inches apart. The main purpose of the inlet baffles is to dissipate the kinetic energy of the incoming water and reduce the velocity of the flow toward the weir.

M.1.3.9 Effect on dewatering. Design of the secondary area must consider dewatering of the primary area. If the primary area is to be dewatered using the primary weir box to drain the water, the elevation of the surface of the water or stored material in the secondary area must be lower than the final elevation of the stored material to be attained during dewatering. The elevation difference should be at least 2 ft if the drainage is to be treated. The point is demonstrated in Figure M-6.

M.1.3.10 Alternatives. There are several alternatives that can be used to provide for dewatering:

- a. The secondary area can be constructed at a lower elevation.
- b. The settled, treated material stored in the secondary area can be dewatered and thereby consolidated first.
- c. The material can be pumped out of the secondary area.
- d. The water can be pumped out of the primary area.
- e. A special drainage structure can be constructed to drain the primary cell.
- f. A channel can be cut through the settled material in the secondary area to permit drainage through the basin. The best approach depends on site- and project-specific considerations. The effect of treatment on dewatering of the primary area is just one example showing that the designer should consider the entire placement operation when designing the treatment system. Treatment should not be added to a placement operation as an afterthought.

#### M.1.4 General design considerations.

M.1.4.1 Shelter. A building should be provided to house the equipment and to furnish shelter for the operators. An 8-ft x 12-ft portable building is sufficient unless the polymer storage tank and dilution tanks must be housed.

M.1.4.2 Equipment. The equipment should be simple, rugged, heavy-duty, continuous-duty, and low-maintenance. Backup equipment must be provided for all essential components.

M.1.4.3 Safety. Good lighting must be provided for the entire work area. The weir must be furnished with a walkway and railings. Provisions should be made for safe, simple adjustments of the weir boarding.

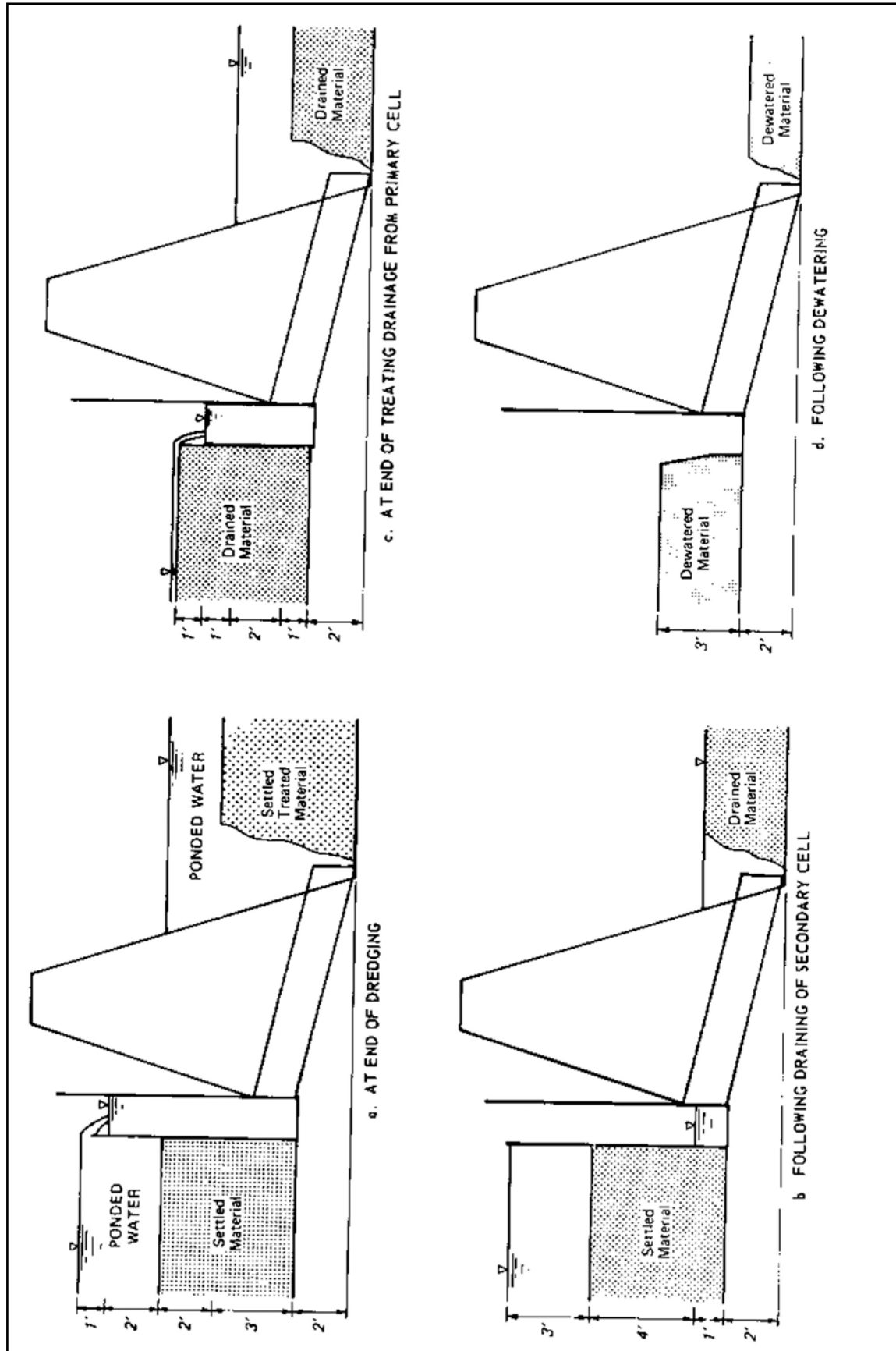

Figure M-6. Example Elevations in Containment Areas During the Dewatering Sequence

M.1.5 Operating guidelines. Prior to the start of the project, an operator's manual and treatment log book should be prepared to minimize problems during the operation of the treatment system. The operator's manual should contain the maintenance schedule, procedures for operating each piece of equipment and the weir, and the procedures for adjusting the polymer dosage. The treatment log book should be used to keep a complete record of the treatment operation. The record should include hours of operation, flow rate, polymer dosage, influent and effluent turbidity, basin depths, depth of settled treated material, maintenance actions, problems, and significant observations.

M.1.5.1 Maintenance schedule. The maintenance schedule and operating procedures for the equipment are dependent on the equipment selection and should be developed specifically for the selected pieces. To set the polymer dosage, it is first necessary to calibrate the polymer pump. The polymer flow rate should be measured for the range of controller settings. Next, based on the laboratory results, a table should be prepared that gives the required dosage as a function of influent turbidity. Then, a table of controller settings should be prepared for a variety of dosages and flow rates. At low flow rates, there is less mixing, and the polymer is less effective. Therefore, higher dosages are often required at low flow. If a relationship between mixing and the required dosage was developed in the laboratory, that relationship should be converted to relate the flow rate and the dosage so the operator can readily adjust the dosage. The required dosages must be verified during the start of operation, and the values in the tables must be adjusted accordingly. After verification of the dosages, the operator has only to measure the influent turbidity and flow rate to determine the controller setting for the polymer pump.

M.1.5.2 Field dosage verification. During verification of the required dosages, the effectiveness of a particular dosage can be evaluated immediately by grabbing a sample of treated suspension from the end of the discharge culvert connecting the two containment areas and running a column settling test on the sample. If the supernatant is clear after 10 min of settling, the dosage should be decreased until the supernatant is slightly cloudy. Better clarification is achieved in the settling basin, where the material can flocculate. This is especially true when the system has been operating continuously for a long period. After a dosage is selected, the effluent turbidity should be monitored to determine whether the dosage should be adjusted further. The dosage should be minimized to reduce chemical costs, but the effluent quality should not be allowed to deteriorate beyond the effluent requirements.

#### M.1.5.3 Flow measurement.

a. The flow rate can be estimated by measuring the weir length and the depth of water flowing over the weir crest, as described in Chapter 4, "Confined (Diked) Placement."

b. A table relating the depth of flow over the weir  $h$  and the flow rate  $Q$  should be generated and included in the operator's manual. The weir length should be measured, not taken from design drawings, to ensure accuracy. Using this table, the operator can easily estimate the flow rate by measuring the depth of flow without performing any difficult computations or requiring additional information. The operator should measure the depths at several locations along the weir crest and average the resulting flow rates to determine the overall flow rate. This method minimizes the estimating errors caused by an unlevel or uneven weir crest.

31 Jul 15

c. The weir crest may become submerged at flow greater than 20% above the average. The actual flow rate that submerges the weir is dependent on the weir length and culvert design. The flow rate over submerged weirs is controlled by the discharge capacity of the culvert.

#### M.1.5.4 Weir operation.

a. The weir must be properly operated to maintain good mixing conditions. The weir crest must be kept sufficiently high to maintain the required difference in elevation between the water surfaces of the two containment areas. The weir should also be used to maintain the required flow rate for good mixing. When the flow decreases below the minimum rate for good mixing, the operator should either lower the weir crest by 1 or 2 in. to increase the flow to its average rate or raise the weir crest sufficiently to stop the flow.

b. The minimum flow rate is based on the experimentally determined minimum acceptable mixing ( $Gt$ ) for effective treatment. The minimum flow can be determined as follows:

$$Q_{\min} = Q_{\text{avg}} \frac{Gt_{\min}^2}{Gt_{\text{avg}}} \quad (\text{M-22})$$

An example computation is provided below:

Given:           Average flow = 25 ft<sup>3</sup>/sec  
                        $Gt$  of average flow = 9,000  
                       Minimum acceptable  $Gt$  = 6,000

The minimum allowable flow is

$$Q_{\min} = 25 \frac{\text{ft}^3}{\text{sec}} = \left( \frac{6,000^2}{9,000} \right) = 11.1 \frac{\text{ft}^3}{\text{sec}}$$

c. In general, the weir crest should be operated at the highest practical elevation, and the primary containment area should be allowed to fill to this elevation before any water is discharged over the weir and treatment is started. This maximizes the depth and provides the best conditions for mixing, settling, and storage. Maintaining the maximum ponded depth in the primary area also minimizes the turbidity of the discharge to be treated and, therefore, reduces the required polymer dosage.

#### M.1.5.5 Other considerations.

a. General operation. During the project, the primary and secondary effluent turbidities and the flow rate should be measured at least six times per day, and the polymer flow rate should be adjusted as needed. Each piece of equipment should be inspected regularly, particularly the water intake, injection rig, and pumps. The fuel and chemical levels should also be checked as

required. Regular maintenance must be performed throughout the project. The buildup of settled treated material should be followed, and the material should be pumped out of the basin as the storage volume is depleted.

b. Leakage. The operator should try to eliminate leakage through the weir when the treatment system is turned off. The flow rate of the leakage is too low to treat, but after a couple of days of downtime, the leakage can completely exchange the contents of the secondary area if left unchecked. Since it is untreated, the effluent quality will deteriorate markedly.

c. Dewatering. At the end of the project, the treatment system can be used to treat the drainage from the primary containment area during dewatering. The elevation of the interface of the settled material in the primary area must be greater than the elevation of the water surface of the secondary area. Therefore, the secondary area must be dewatered first to compact the settled treated material and then to provide the depth required to treat the drainage at the lower weir height. It is possible that treated material may need to be pumped from the secondary area before the primary area can be dewatered through the weir.

**M.2 Polymer Feed System Design Example.** Given the following project information and laboratory results, the design would proceed as follows:

**M.2.1 Project information:**

In situ sediment volume	200,000 yd <sup>3</sup>
In situ sediment concentration	900 g/L
Specific gravity of sediment	2.68
Dredged material slurry concentration	150 g/L
Dredge discharge pipe size	14 in.
Production time	100 h/week
Average concentration of settled material	400 g/L
Mean daily temperature	50 °F

**M.2.2 Laboratory results:**

Selected polymer	low viscosity liquid
Specific weight of polymer	1.0 kg/L
Required dosage at average flow and turbidity	10 mg/L
Polymer feed concentration	20 g/L

**M.2.3 Polymer requirements:**

$$\begin{aligned} \text{volume of inflow, L} &= 200,000 \text{ yd}^3 \times 900 \text{ g/L} \times 764.4 \text{ L/yd}^3 \div 150 \text{ g/L} \\ &= 9.17 \times 10^8 \text{ L} \end{aligned} \quad (\text{M-23})$$

$$\begin{aligned} \text{volume of settled material, L} &= 9.17 \times 10^8 \text{ L} \times 150 \text{ g/L} \div 400 \text{ g/L} \\ &= 3.44 \times 10^8 \text{ L} \end{aligned} \quad (\text{M-24})$$

31 Jul 15

$$\begin{aligned} \text{volume to be treated, L} &= 9.17 \times 10^8 \text{ L} - 3.44 \times 10^8 \text{ L} \\ &= 5.733 \times 10^8 \text{ L} \end{aligned} \quad (\text{M-25})$$

$$\begin{aligned} \text{volume of polymer required, gal} &= 10 \text{ mg/L} \times 5.733 \times 10^8 \text{ L} \\ &\div 1.10 \text{ kg/L} \div 10^6 \text{ mg/kg} \\ &\div 3.785 \text{ L/gal} = 1,380 \text{ gal} \end{aligned} \quad (\text{M-26})$$

$$\begin{aligned} \text{pounds of polymer required, lb} &= 1,380 \text{ gal} \times 3.785 \text{ L/gal} \\ &\times 1.10 \text{ kg/L} \times 2.205 \text{ lb/kg} \\ &= 12,640 \text{ lb} \end{aligned} \quad (\text{M-27})$$

M.2.4 Storage. Since less than 2,000 gal of polymer is required, drums should be used for storage instead of a bulk tank. The drums may be stored outside since they are not expected to freeze during the project. However, barrel warmers should be used to aid in transferring the polymer to the feed tank due to the cool temperature. A hand pump or a small electric positive displacement pump should be used for the transfer from storage.

M.2.5 Polymer pump. The feed system shown in Figure M-1 should be used since the selected polymer is a liquid of low viscosity requiring a fiftyfold dilution. The average polymer flow rate is

$$\text{avg. dredge flow rate} = 15 \text{ ft/sec} \times \pi/4 \times (14 \text{ in.} \div 12 \text{ in./ft})^2 = 16.04 \text{ ft}^3/\text{sec}$$

$$\begin{aligned} \text{avg. polymer flow rate} &= 16.04 \text{ ft}^3/\text{sec} \times 10 \text{ mg/L} \times 28.31 \text{ L/ft}^3 \\ &\div 1.10 \text{ g/mL} \div 1,000 \text{ mg/g} = 4.13 \text{ mL/sec} \\ &= 0.065 \text{ gal/min or } 94.2 \text{ gal/day} \end{aligned}$$

The polymer pump capacity should be about four times the average rate or 0.25 gal/min. The pump should be capable of pumping as low a flow as 0.4 mL/sec or 0.0065 gal/min.

M.2.6 Polymer feed tank. The polymer feed tank should be sized to hold a 2-day supply of polymer. The tank should be kept in a heated shelter with the pumping equipment.

$$\begin{aligned} \text{tank volume} &= 94.2 \text{ gal/day} \times 2 \text{ days} \times (0.8, \text{ the production efficiency}) \\ &= 150 \text{ gal} \end{aligned}$$



M.2.7 Dilution water pump. To reduce the polymer feed concentration below 20 g/L, the dilution factor must be 55. At average polymer flow rate, the required dilution water flow rate would be 3.6 gal/min. The dilution water pump capacity should be twice this rate to dilute higher polymer flow adequately. Therefore, the dilution water flow rate should be

$$\begin{aligned} \text{dilution water pump rate} &= [(1.1 \times 1,000 \text{ g/L}) / 20 \text{ g/L}] \\ &\quad \times 2 \times 0.0654 \text{ gal/min} = 7.20 \text{ gal/min} \end{aligned}$$

The pump must deliver this flow rate and produce high pressure (60 lb/in.<sup>2</sup>) to force the viscous polymer solution through the eductor, feed lines, and injector.

M.2.8 Feed lines. The size of the feed lines should be determined by head loss analysis for pipe flow. This subject is discussed in any fluid mechanics textbook or hydraulics handbook. The pipe diameter is dependent on the viscosity, flow rate, length of line, minor losses, and losses through the eductor and injector. One-inch inside diameter (ID) rubber hose or PVC pipe should be used for this example. The head loss would be less than 30 lb/in.<sup>2</sup>.

M.3 Example Culvert Design. Given an 18-in.-diam dredge pipeline, a minimum head difference of 3 ft between the primary and secondary cells, and a range of culvert lengths between 50 and 100 ft based on the containment area design, the culvert design would proceed as follows:

$$\begin{aligned} \text{M.3.1 } Q_{\max} &= 15 \text{ ft/sec} \times \pi(18 \text{ in.}/12 \text{ in./ft})^2 \div 4 \\ &= 26.5 \text{ ft}^3/\text{sec} \end{aligned}$$

$$\begin{aligned} Q_{\text{ave}} &= 26.5 \text{ ft}^3/\text{sec} \times (\text{production ratio, } 0.75) \\ &= 19.9 \text{ ft}^3/\text{sec} \end{aligned}$$

$$\text{M.3.2 } Dh = 3 \text{ ft}$$

$$H = 3 \text{ ft} - 0.5 \text{ ft} = 2.5 \text{ ft}$$

31 Jul 15

M.3.3 Using Equation M-11, the calculated minimum diameters for given lengths and numbers of culverts are presented in the following tabulation.

$N$	$L$ , ft	$D$ , ft	$D$ , in.
1	50	2.23	26.8
1	100	2.44	29.3
2	50	1.67	20.0
2	100	1.85	22.2
3	50	1.42	17.0
3	100	1.57	18.8
4	50	1.26	15.1
4	100	1.41	16.9
5	50	1.15	13.8
5	100	1.29	15.5

M.3.4 Using Equation M-12, the selected commercial sizes and calculated lengths are as follows:

$N$	$D$ , in.	$L$ , ft
1	27	54.1
2	21	69.3
3	18	73.3
4	18	100.0
5	15	83.0

M.3.5 Using Equation M-13, the friction factor and velocity at average flow are as follows:

$N$	$D$ , in.	$v$ , ft/sec	$f$
1	27	5.00	0.0882
2	21	4.14	0.0959
3	18	3.75	0.1010
4	18	2.82	0.1010
5	15	3.24	0.1073

M.3.6 Using Equation M-14, the mixing  $Gt$ s at average flow are as follows:

$N$	$D$ , in.	$L$ , ft	$G$ , $\text{sec}^{-1}$	$t$ , sec	$Gt$
1	27	54.1	449	10.8	4,855
2	21	69.3	400	16.7	6,690
3	18	73.3	382	19.5	7,470
4	18	100.0	249	35.5	8,830
5	15	83.0	346	25.6	8,870

M.3.7 Head loss at average flow is calculated to be

$$H = 1.41 \text{ ft}$$

M.3.8 Flow through a completely submerged weir is calculated to be

$$Q = 29.0 \text{ ft}^3/\text{sec}$$

M.3.9 Generally, a  $Gt$  of about 8,000 provides adequate mixing for chemical treatment. In this example, either three 18-in.-diam, 73-ft-long culverts; four 18-in.-diam, 100-ft-long culverts; or five 15-in.-diam, 83-ft-long culverts could be used. However, four 18-in.-diam culverts would be the best design since it would provide considerably more mixing than three culverts and about the same mixing as five culverts. Also, this design would provide better mixing at lower flow rates.

M.4 Design Example. Given the following project information, the settling basin size would be determined as follows:

M.4.1 Project information.

Primary effluent solids concentration	2 g/L
Secondary effluent solids concentration	50 mg/L
Volume to be treated (as determined in the polymer feed system design)	$5 \times 10^8 \text{ L}$
Depth of basin	6 ft
Average flow rate	$16 \text{ ft}^3/\text{sec}$

M.4.2 Volume of settled treated material (assuming a ponded depth of 3 ft).

From Equation M-15

$$\begin{aligned} \text{mass of settled material} &= (2 - 0.05) \text{ g/L} \times 5 \times 10^8 \text{ L} \\ &= 9.75 \times 10^8 \text{ g} \end{aligned}$$

From Equation M-16

$$\begin{aligned} \text{avg. conc. of settled material} &= [(2 \times 50 \text{ g/L}) \\ &+ (25 \text{ g/L-ft} \times 3 \text{ ft})] \div 2 = 88 \text{ g/L} \end{aligned}$$

From Equation M-17

$$\begin{aligned} \text{volume of settled material} &= 9.75 \times 10^8 \text{ g} \div 88 \text{ g/L} = 1.11 \times 10^7 \\ &= 3.91 \times 10^5 \text{ ft}^3 \text{ or } 9.0 \text{ acre-ft} \end{aligned}$$

31 Jul 15

M.4.3 Required area based on storage.

From Equation M-18

$$\text{Area} = 9.0 \text{ acre-ft} \div 3 \text{ ft} = 3.0 \text{ acres}$$

M.4.4 Volume of ponding.

From Equation M-19

$$\text{Ponded volume} = 16 \text{ ft}^2/\text{sec} \times 9,000 \text{ sec} = 1.44 \times 10^5 \text{ ft}^3 \text{ or } 3.3 \text{ acre-ft}$$

M.4.5 Required area based on ponding.

From Equation M-20

$$\text{Area} = 3.3 \text{ acre-ft} \div 3 \text{ ft} = 1.1 \text{ acres}$$

M.4.6 Second trial. The areas based on storage and ponding are quite different. Therefore, the ponded depth should be decreased to reduce the area required for storage.

Using a ponded depth of 2 ft and, therefore, a storage depth of 4 ft,

From Equation M-15

$$\text{Avg. conc. of settled material} = [(2 \times 50 \text{ g/L}) + (25 \text{ g/L-ft} \times 4 \text{ ft})] \div 2 = 100 \text{ g/L}$$

From Equation M-17

$$\begin{aligned} \text{Volume of settled material} &= 9.75 \times 10^8 \text{ g} \div 100 \text{ g/L} \\ &= 9.75 \times 10^6 \text{ L} \\ &= 3.45 \times 10^5 \text{ ft}^3 \\ &= 7.9 \text{ acre-ft} \end{aligned}$$

From Equation M-17b

$$\text{Area for storage} = 7.9 \text{ acre-ft} \div 4 \text{ ft} = 1.98 \text{ acres}$$

From Equation M-18

$$\begin{aligned} \text{Ponded volume} &= 16 \text{ ft}^2/\text{sec} \times 9,000 \text{ sec} \\ &= 1.44 \times 10^5 \text{ ft}^3 \\ &= 3.3 \text{ acre-ft} \end{aligned}$$

From Equation M-19

$$\text{Area for ponding} = 3.3 \text{ acre-ft} \div 2 \text{ ft} = 1.65 \text{ acres}$$

M.4.7 Final design. The two areas in the second trial are similar, indicating a better design. Therefore, the secondary cell should have the following characteristics:

Volume	12 acre-ft or $5.2 \times 10^5 \text{ ft}^3$
Area	2 acres
Depth	6 ft
Storage depth	4 ft
Ponded depth	2 ft

#### M.5 Mud Pumping.

M.5.1 If the basin is not used for storage (that is, if the settled material is pumped out regularly, the area and depth of the basin can be reduced further to about an area of 1.0 acre and a depth of 5 ft. With a shallow storage depth, the solids concentration of the settled material would be about 60 g/L.

M.5.2 The mud pumping rate, assuming 16 hr of production per day would be

From Equation M-20

$$\begin{aligned} \text{solids pumping rate} &= (2.0 - 0.05) \text{ gal/L} \\ &\times 28.31 \text{ L/ft}^3 \times 16 \text{ ft}^3/\text{sec} \\ &\times 16 \text{ hr/day} \times 3,600 \text{ sec/hr} \\ &= 5.09 \times 10^7 \text{ gal/day} \end{aligned}$$

From Equation M-21

$$\begin{aligned} \text{volumetric pumping rate} &= 5.09 \times 10^7 \text{ gal/day} \div 60 \text{ gal/L} \\ &= 8.5 \times 10^5 \text{ L/day} \\ &= 0.347 \text{ ft}^3/\text{sec} \text{ or } 156 \text{ gal/min} \end{aligned}$$

EM 1110-2-5025  
31 Jul 15

THIS PAGE INTENTIONALLY LEFT BLANK

## APPENDIX N

### Monthly Standard Class "A" Pan Evaporation for the Continental United States

N.1 Purpose. This appendix presents evaporation charts for the Continental United States.

N.2 Evaporation Charts. The evaporation charts in figures N-1 through N-12 are based on U.S. National Weather Service (NWS) data.

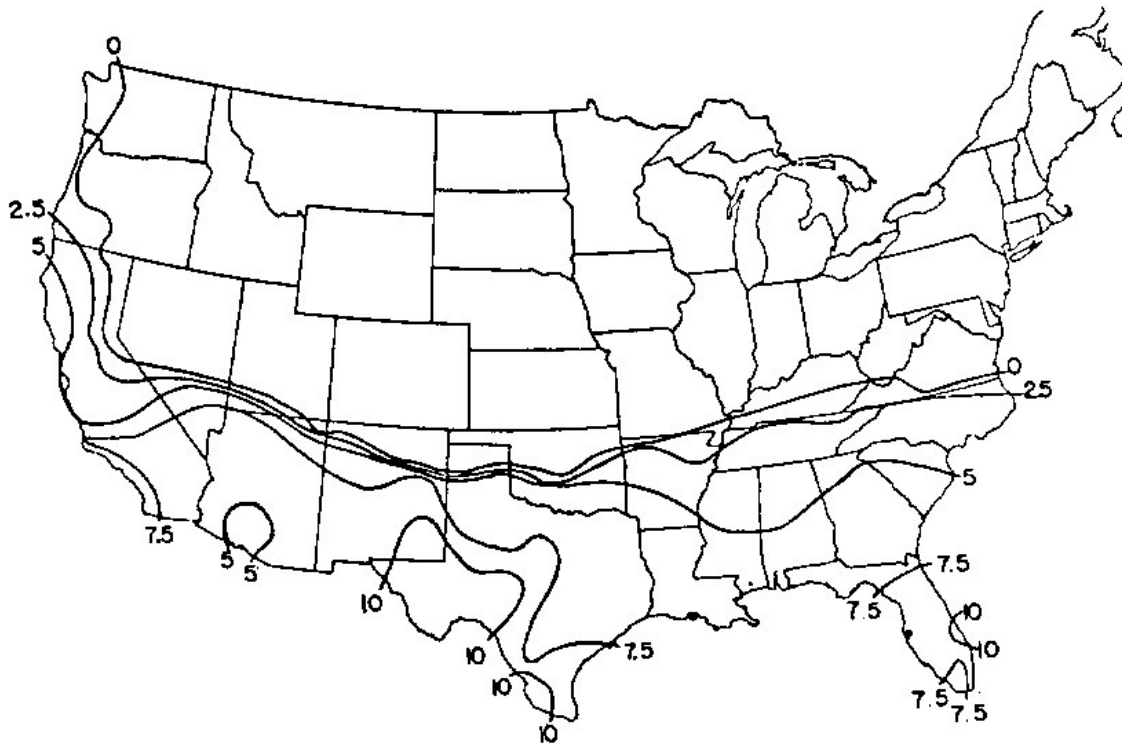

Figure N-1. Average Pan Evaporation, in Centimeters, for the Continental United States for the Month of January, Based on Data Taken from 1931 to 1960

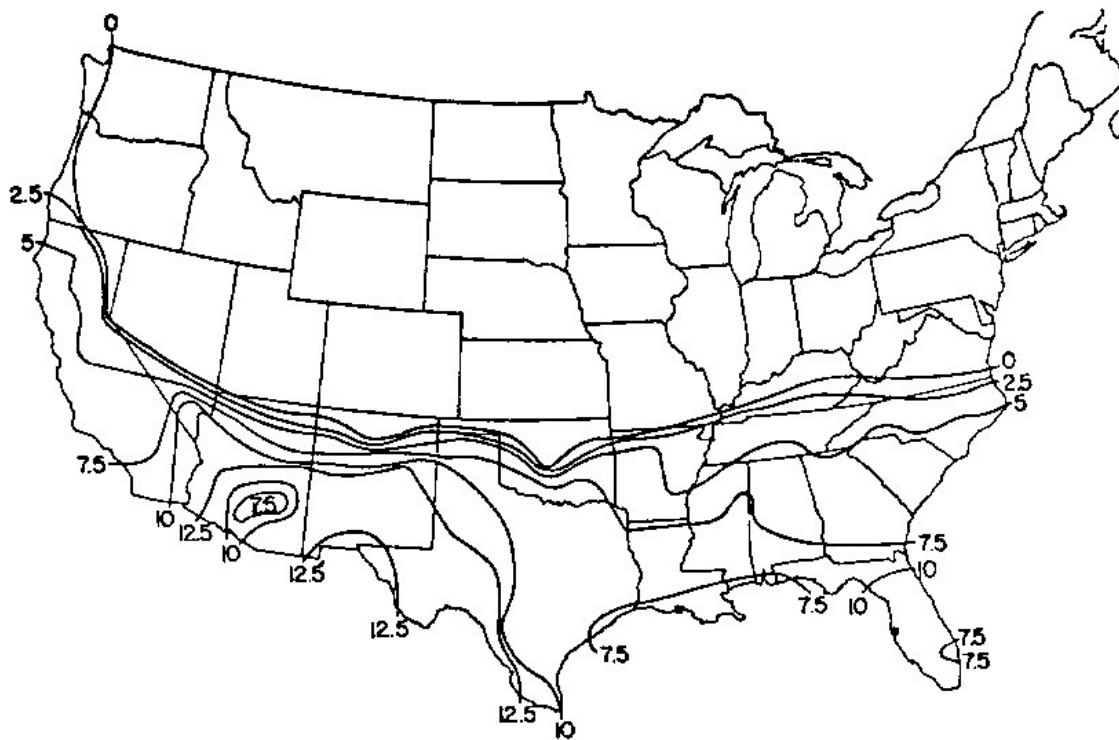

Figure N-2. Average Pan Evaporation, in Centimeters, for the Continental United States for the Month of February, Based on Data Taken from 1931 to 1960

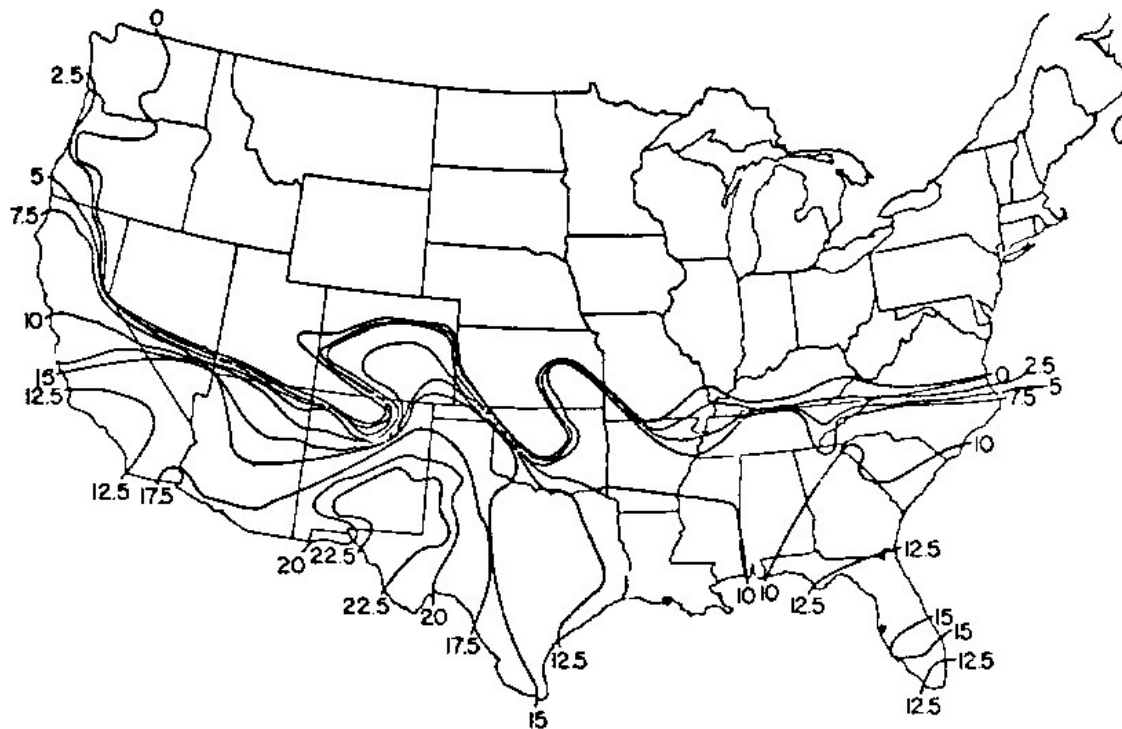

Figure N-3. Average Pan Evaporation, in Centimeters, for the Continental United States for the Month of March, Based on Data Taken from 1931 to 1960



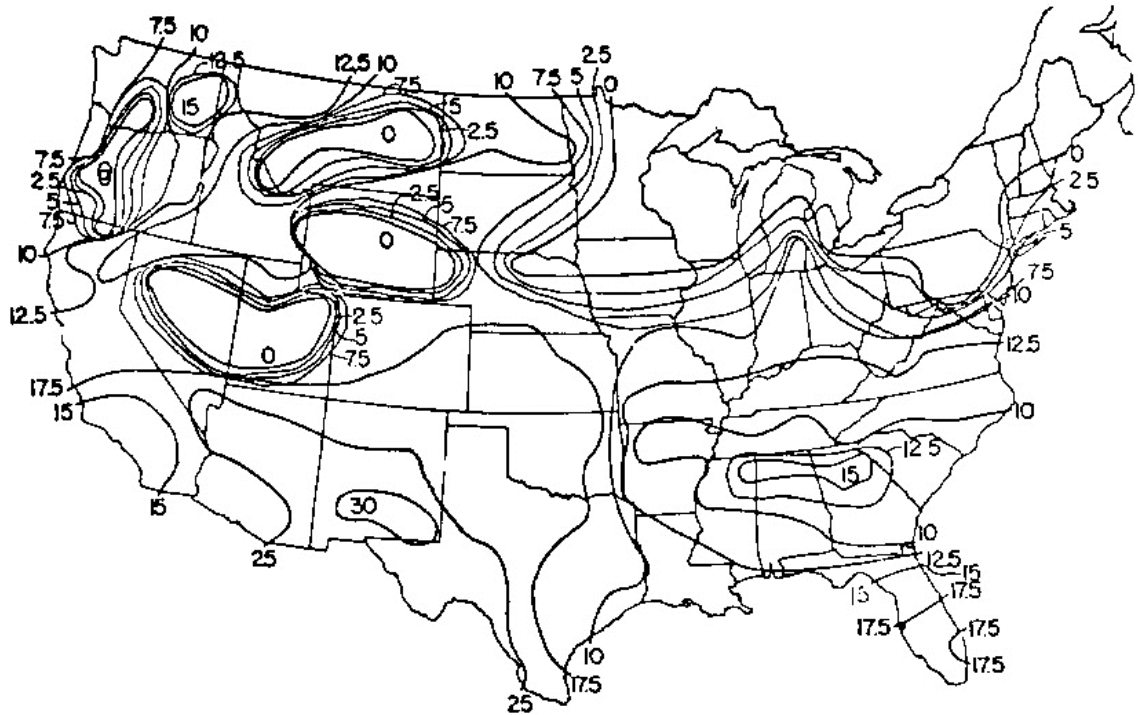

Figure N-4. Average Pan Evaporation, in Centimeters, for the Continental United States for the Month of April, Based on Data Taken from 1931 to 1960

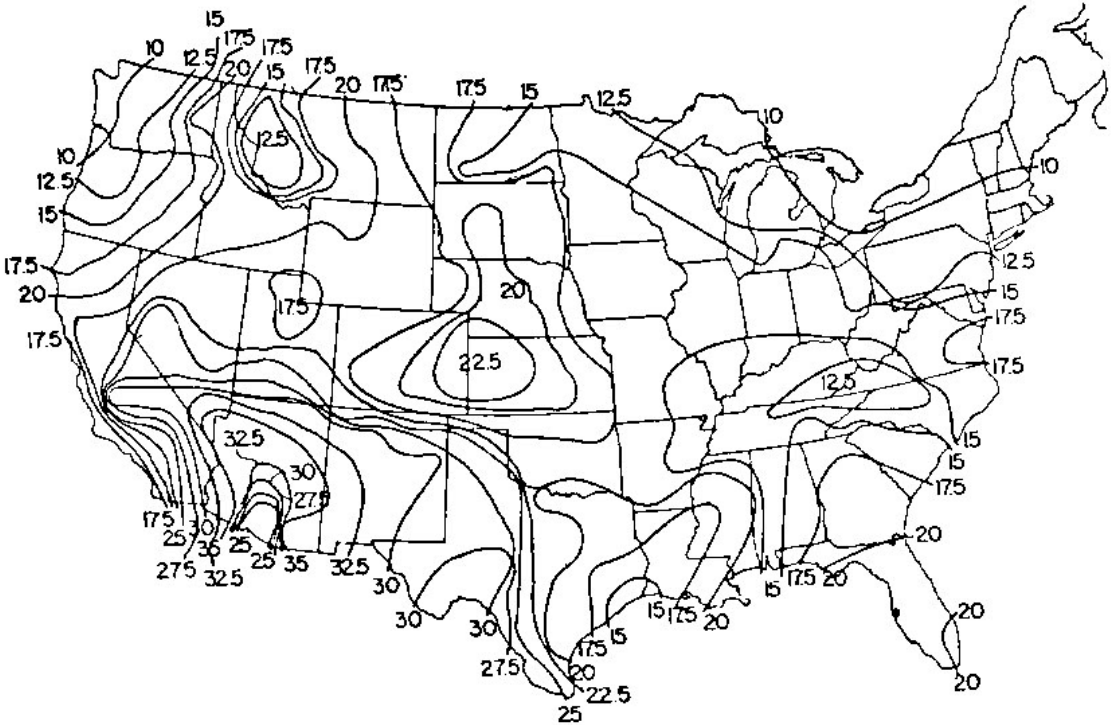

Figure N-5. Average Pan Evaporation, in Centimeters, for the Continental United States for the Month of May, Based on Data Taken from 1931 to 1960

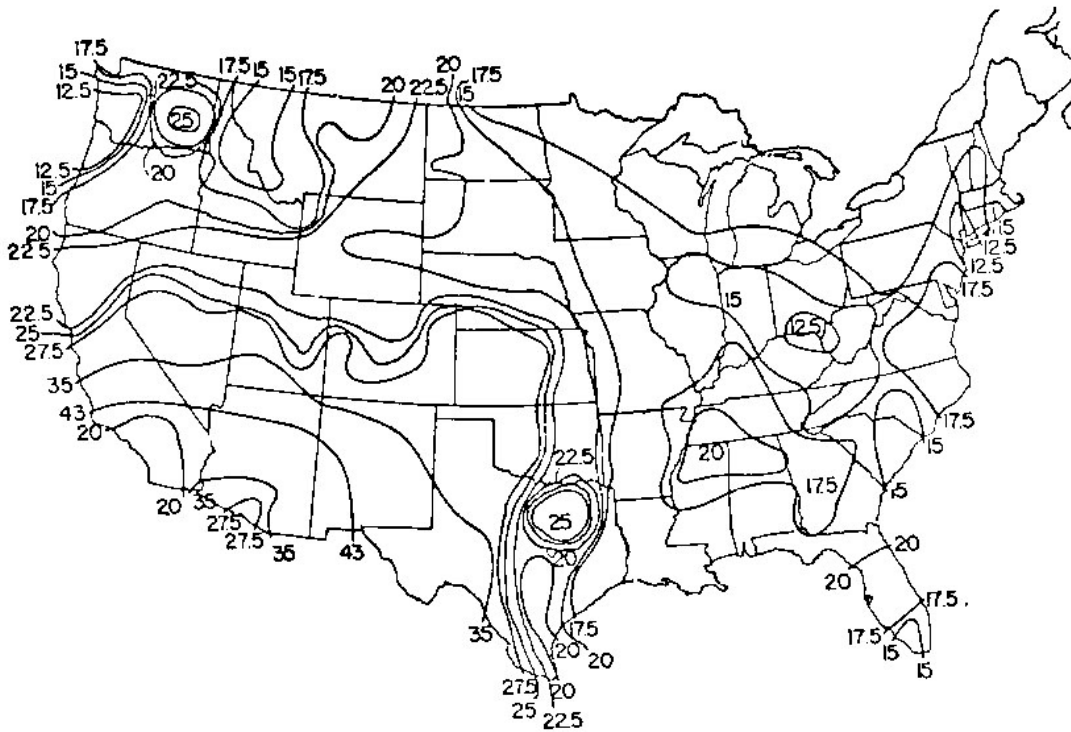

Figure N-6. Average Pan Evaporation, in Centimeters, for the Continental United States for the Month of June, Based on Data Taken from 1931 to 1960

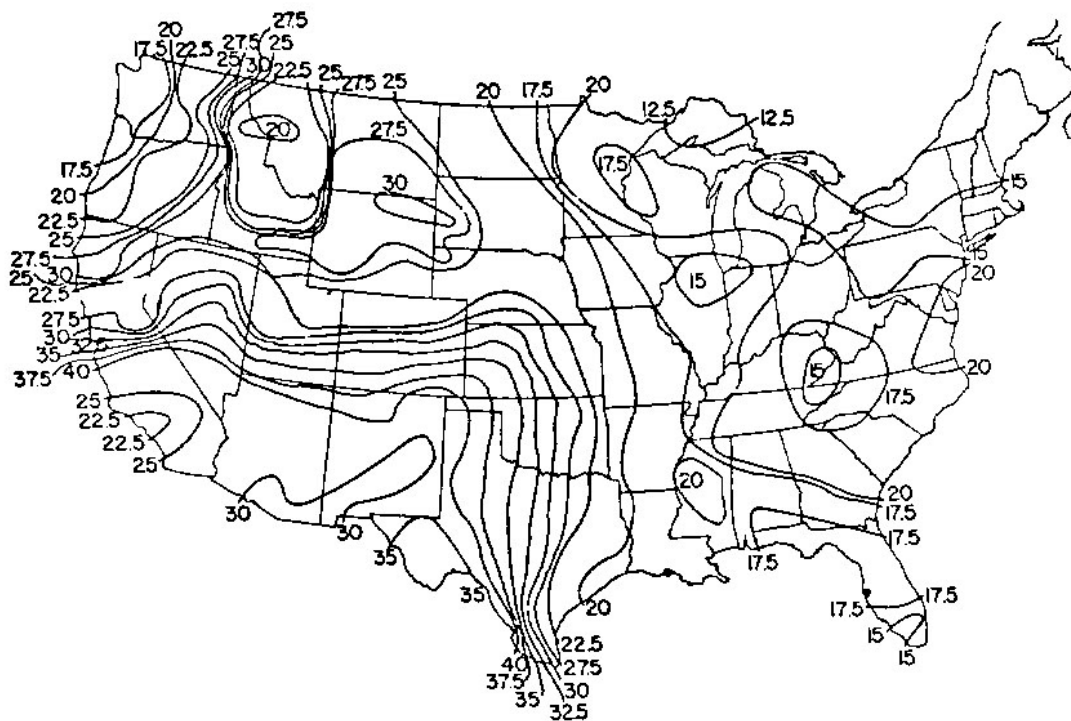

Figure N-7. Average Pan Evaporation, in Centimeters, for the Continental United States for the Month of July, Based on Data Taken from 1931 to 1960

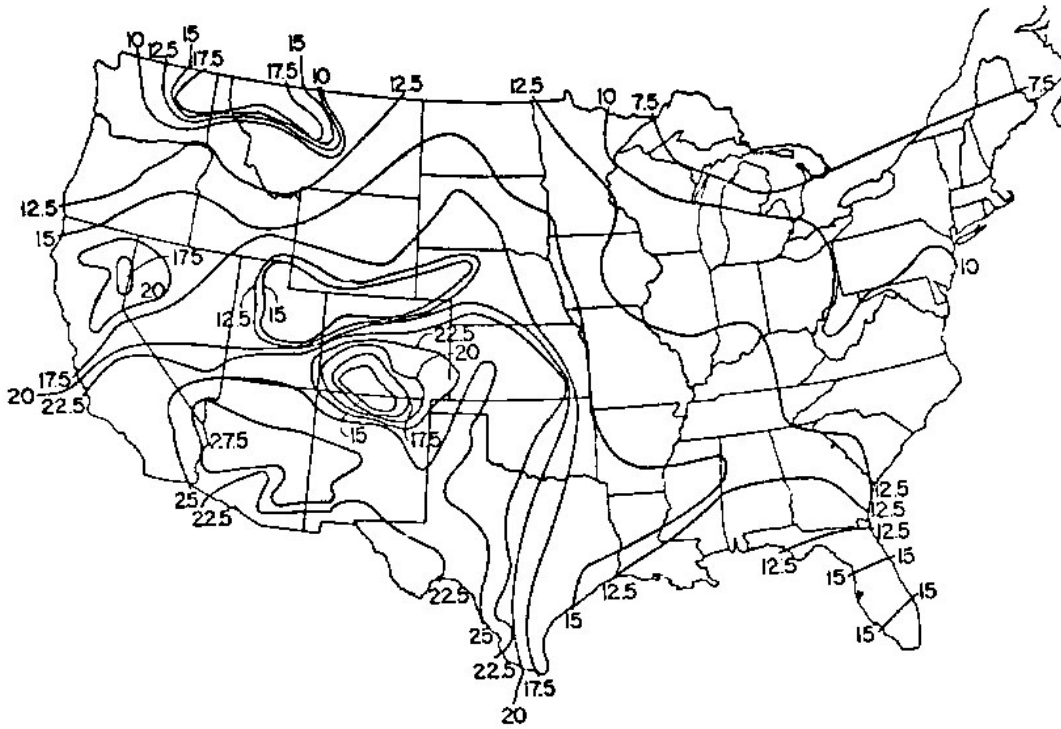

Figure N-8. Average Pan Evaporation, in Centimeters, for the Continental United States for the Month of August, Based on Data Taken from 1931 to 1960

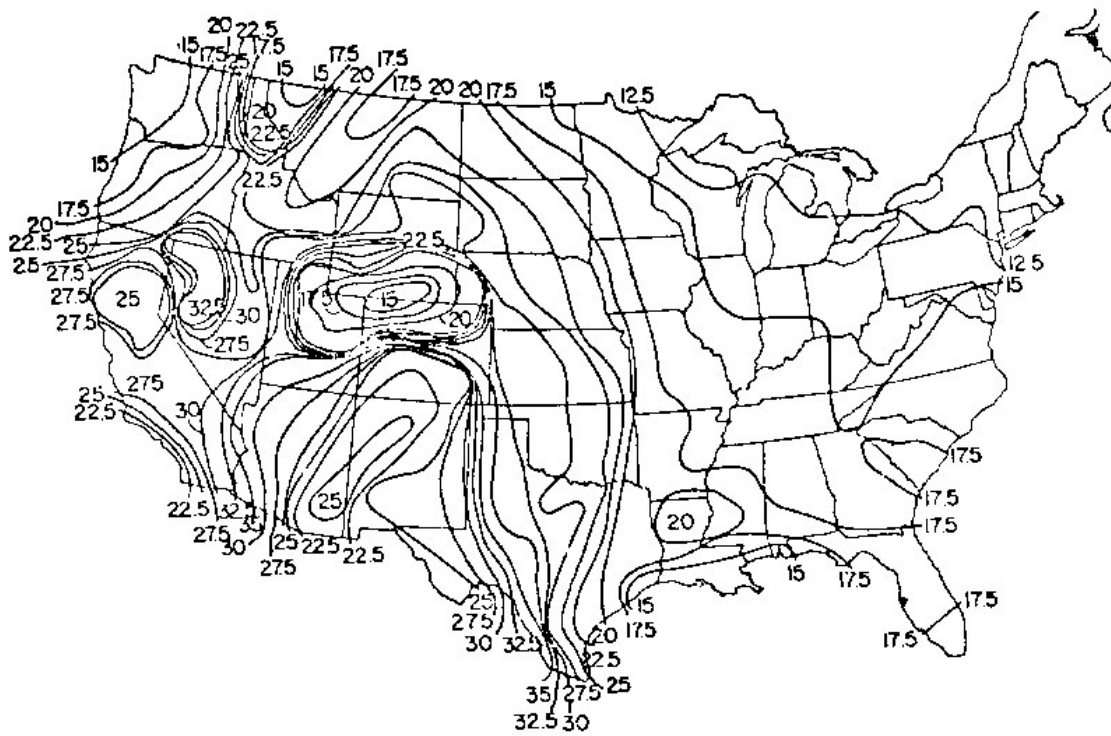

Figure N-9. Average Pan Evaporation, in Centimeters, for the Continental United States for the Month of September, Based on Data Taken from 1931 to 1960

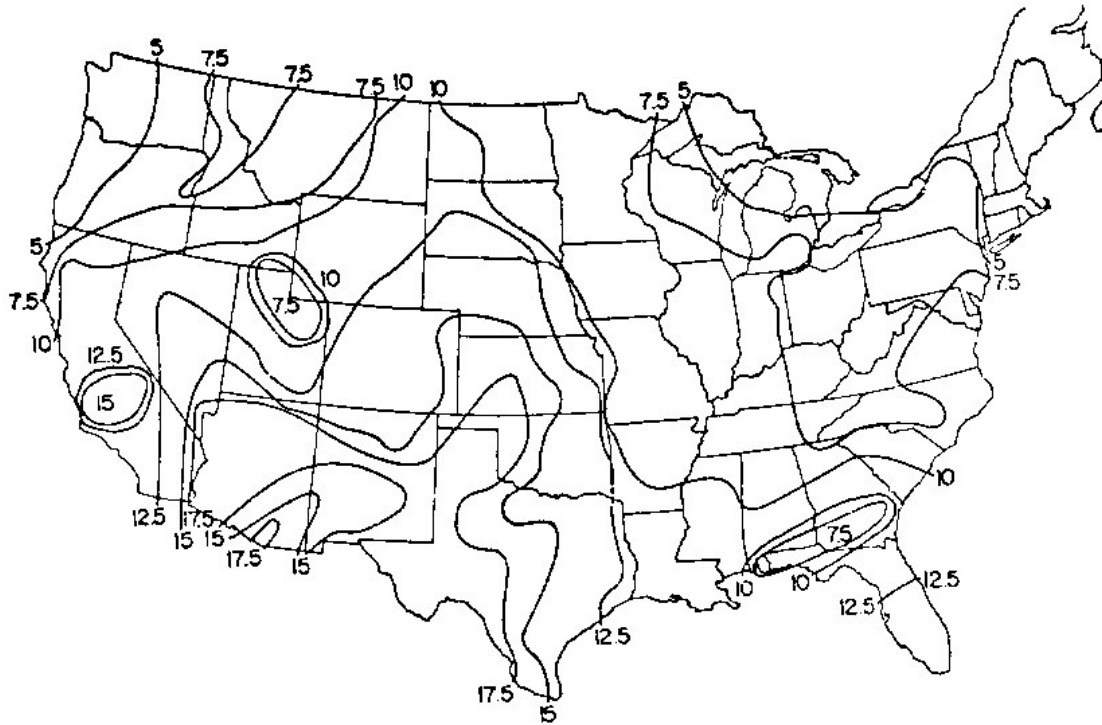

Figure N-10. Average Pan Evaporation, in Centimeters, for the Continental United States for the Month of October, Based on Data Taken from 1931 to 1960

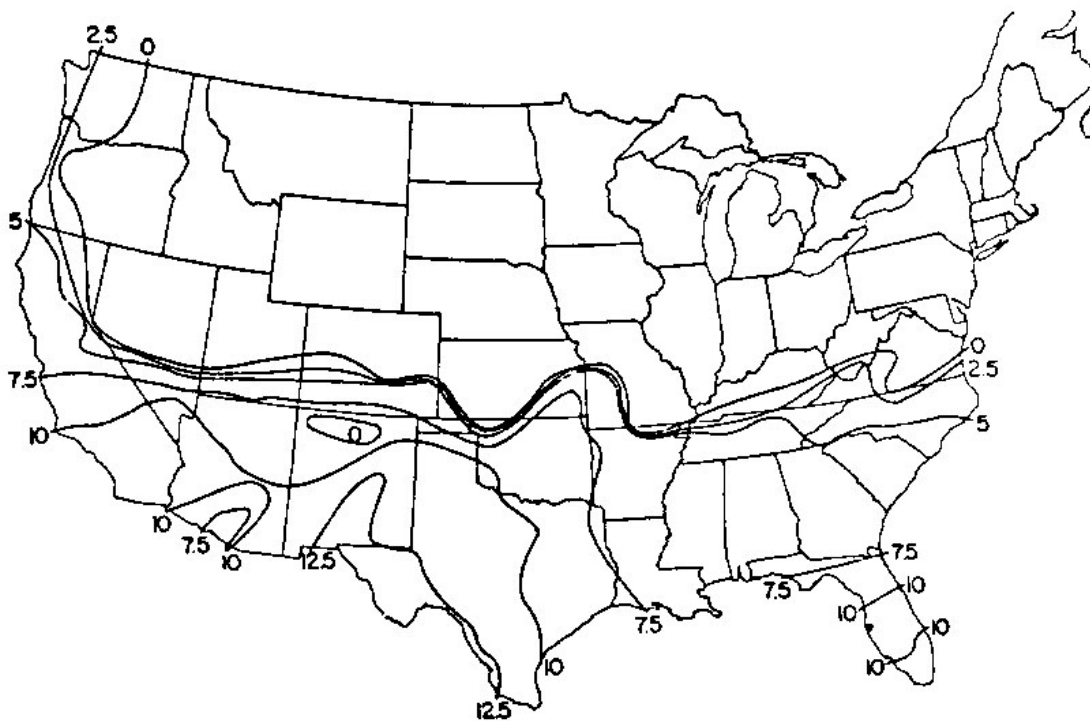

Figure N-11. Average Pan Evaporation, in Centimeters, for the Continental United States for the Month of November, Based on Data Taken from 1931 to 1960

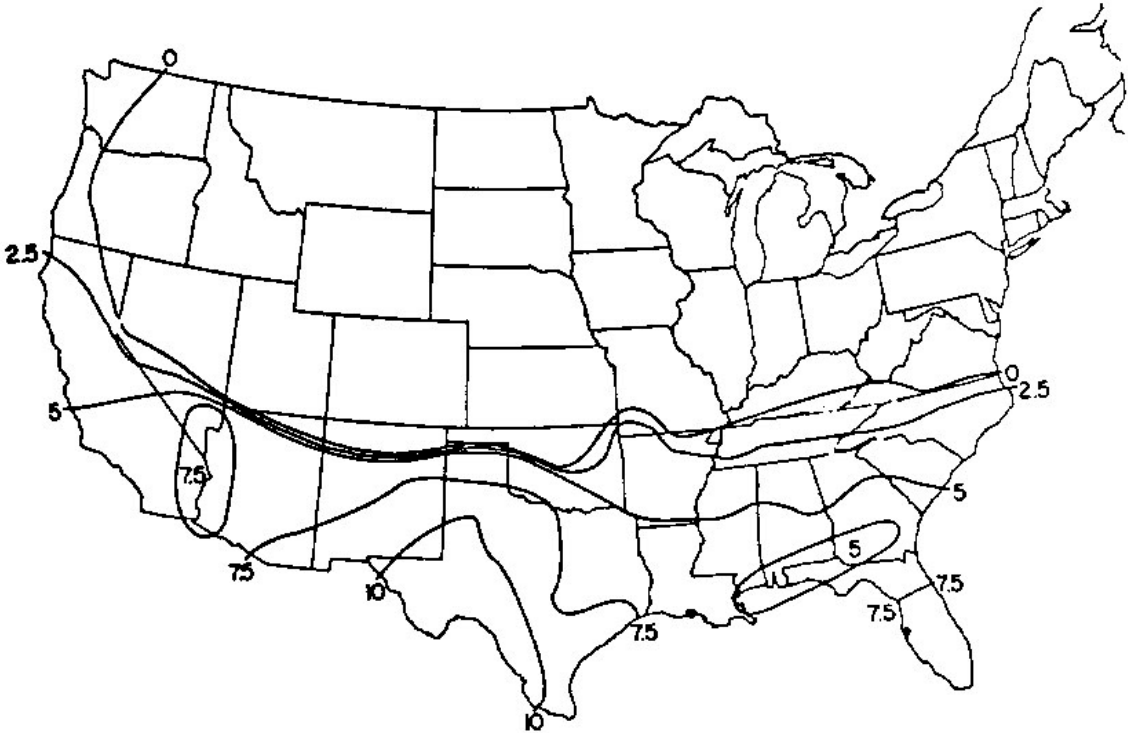

Figure N-12. Average Pan Evaporation, in Centimeters, for the Continental United States for the Month of December, Based on Data Taken from 1931 to 1960

EM 1110-2-5025  
31 Jul 15

THIS PAGE INTENTIONALLY LEFT BLANK

## APPENDIX O

## Procedures for Selecting Equipment for Dewatering Operations

O.1 General Procedures. In order to predict whether draglines and other equipment can operate successfully on perimeter dikes, on interior berms composed of dewatered dredged material, or inside placement sites, criteria have been developed relating vehicle ground pressure, with or without mats, and the rating cone index (RCI) of the supporting soil, as shown in Figure O-1. One or two technicians can rapidly obtain the RCI in the field by hand-pushing a small cone penetrometer through the soil and determining the resistance to penetration. (Under some conditions, field penetration resistance data for remolded material must also be determined.) The critical layer RCI is the lower of the 0-15 cm (0-6 in.) or 15-30 cm (6-12 in.) layer resistance values encountered in the field because if the dragline (or other type of vehicle or equipment) breaks through these layers, soil strength usually decreases even further, and the vehicle becomes immobilized. Caution should be exercised when selecting a vehicle whose ground pressure just equals that obtained from Figure O-1 for the available RCI because of possible undetected soft spots in the area or possible vehicle operation errors that could cause immobilization. WES Technical Report D-77-7 (Willoughby 1977) should be consulted for more exact procedures.

O.2 Effects of Trenching. Once the dragline has moved onto the interior berms to continue the periodic trench deepening operation, criteria are also available, as shown in Figure O-2, to predict the rate at which trenching operations may be conducted. In this figure, which shows linear trenching in feet per hour versus RCI, the RCI is for the soil supporting the dragline. The relationships in Figure O-2 are, at this stage, based on limited data. However, in the absence of better data, they may be used for approximate preliminary estimates of expected behavior.

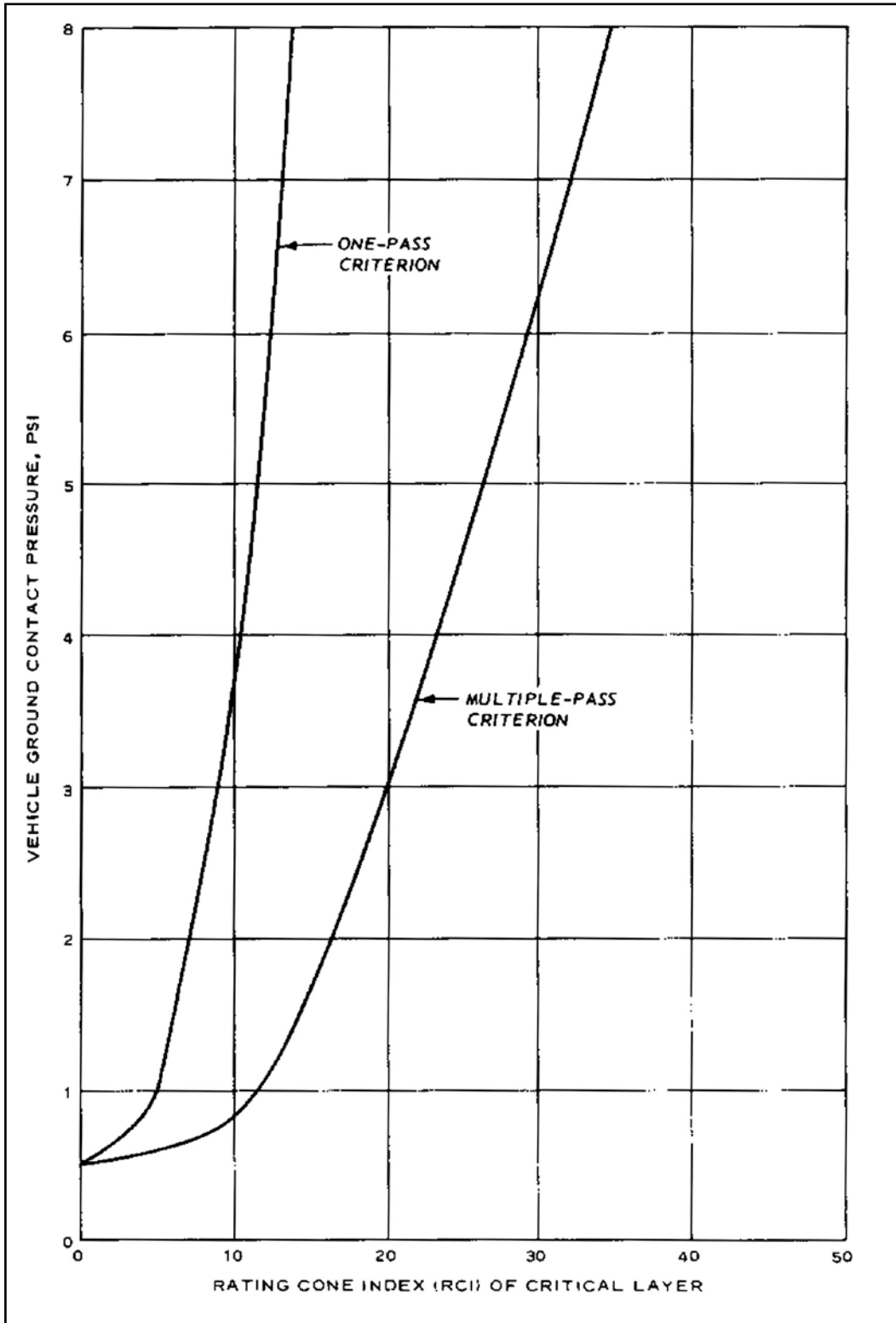

Figure O-1. Relationship Between the RCI Necessary to Ensure Adequate Mobility and the Vehicle Ground Pressure for Single- and Multiple-Pass Operations in Confined Dredged Material Placement Areas



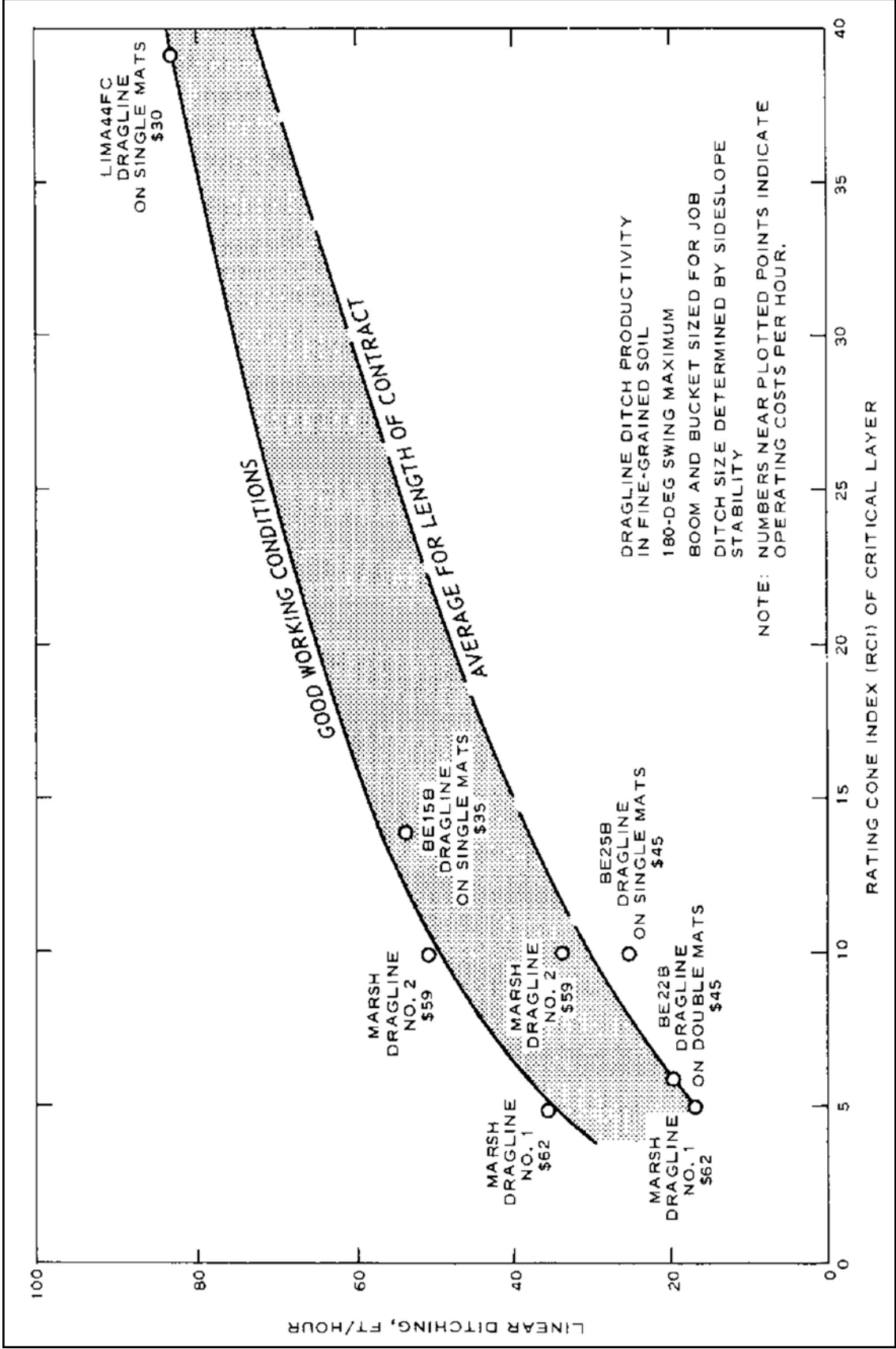

Figure O-2. Relationship Between the RCI of the Confined Disposal Area Surface Crust and the Linear Trenching Rate Obtainable by Dragline Equipment

EM 1110-2-5025  
31 Jul 15

THIS PAGE INTENTIONALLY LEFT BLANK

## APPENDIX P

Dye Tracer Technique to Estimate Mean Residence  
Time and Hydraulic EfficiencyP.1 Fluorescent Dyes.

P.1.1 General. Determination of retention time of ponded water is an important aspect of containment area design for retention of solids. Dye tracer studies may be undertaken to provide retention time data for better operation or management of existing dredged material containment areas. Various artificial tracers have been used to generate inflow and settling data characteristics. Radioactive tracers are effective; however, their use involves troublesome special handling and safety precautions. Commercially produced fluorescent dyes are easier and safer to handle and have been used extensively in inflow studies. Fluorescent materials used in tracing are unique in that they efficiently convert absorbed light into emitted light with a separate characteristic spectrum. Using the proper light source and filters, a fluorometer can measure small amounts of fluorescent material in a sample. Thus, when a fluorescent dye is mixed with a given parcel of water, that parcel may be identified and traced through a water system. The mean residence time and the amount of mixing of the water parcel in the system can be quantified by measuring the time variation of dye concentrations of the water leaving the system.

P.1.2 Physical-chemical considerations. For a given fluorescent dye, the interaction of the dye with surrounding environmental conditions should be considered. Use of a dye in nature's water normally is not affected by chemical changes. However, if the dye were to be used in waters having high chloride concentrations, the dye loss could be significant. Photochemical decay of dye concentration must also be considered when planning a dye tracer study. Factors influencing photochemical decay are light intensity, cloud cover, water turbidity, and water column depth. Other physical-chemical impacts on dyes are related pH, temperature, and salinity. Under acidic conditions, adsorption occurs more strongly, resulting in a reduction in fluorescence. A general rule of thumb on temperature impacts is that fluorescence decreases 5% for every 2° C (3.6° F) increase in temperature. Tests have shown that dye decay occurs at a slower rate under saline conditions (7.02 m sodium chloride solution) (Smart and Laidlaw 1977). Additional guidance for designing dye tracer studies and details of physical-chemical effects on dyes are found in Abood, Lawler, and Disco (1969); Pritchard and Carpenter (1960); Feuerstein and Selleck (1963); Watt (1965); Smart and Laidlaw (1977); Yotsukura and Kilpatrick (1973); Wilson (1968); and Deaner (1973).

P.1.3 Dye types. Fluorescent dyes have been used since the early 1900s. Several have been developed and used with varying degrees of success in the tracing of surface and ground waters. Smart and Laidlaw (1977) evaluated eight dyes: Fluorescein, Rhodamine B, Rhodamine WT, Sulpho Rhodamine B, Lissamine FF, Pyramine, Amino G Acid, and Photine CU. Rhodamine B is stable in sunlight, but it is readily adsorbed to sediments in water. Rhodamine WT was developed specifically for water tracing and is recommended for such routine use.

## P.2 Measurement Techniques.

P.2.1 Theory of operation. Unlike sophisticated and complex analytical laboratory spectrofluorometers, filter fluorometers are relatively simple instruments. Basically, filter fluorometers are composed of six parts: a light (excitation energy) source, a primary or “excitation” filter, a sample compartment, a secondary or “emittance” filter, a photomultiplier, and a readout device.

P.2.1.1 When a fluorescent material is placed in a fluorometer, that spectral portion of the light source that coincides with the peak of the known excitation spectrum of the test material is allowed to pass through the primary filter to the sample chamber. This energy is absorbed by the fluorescent material, causing electrons to be excited to higher energy levels. In returning to its ground state, the fluorescent material emits light that is always at a longer wavelength and lower frequency than the light that was absorbed. It is this property that is the basis of fluorometry, the existence of a unique pair of excitation and emission spectra for different fluorescent materials. Finally, only a certain band of the emitted light, different from that used for excitation, is passed through the secondary filter to the photomultiplier, where a readout device indicates the relative intensity of the light reaching it. Thus, with different light sources and filter combinations, the fluorometer can discriminate between different fluorescent materials.

P.2.1.2 The selection of light sources and filters is crucial since they determine the sensitivity and selectivity of the analysis. Fluorometer manufacturers recommend and supply lamps and filters for most applications, including Rhodamine WT applications.

P.2.1.3 Two types of fluorometers are in common field use today. The standard instrument used in water tracing by many groups, including the USGS (Wilson 1968), has been the Turner Model III manufactured by G. K. Turner Associates. Turner Designs has capitalized on recent advances in electronics and optics and developed a fluorometer, the Model 10 series, that is better adapted to field use than the Turner Model III, but it is also more expensive.

P.2.2 Field use. Once a fluorometer is calibrated, it must be decided where and how field samples will be analyzed—in situ or in a laboratory, continuously or discretely. During in situ analysis, the operation of the fluorometer in flow-through mode (where water from a given discharge point in the containment area is pumped continuously through the sample chamber in the fluorometer) is advantageous over its operation in cuvette mode (where a discrete sample is analyzed). Specifically, in situ flow-through analysis allows the homogeneity of fluorescence in the discharge to be easily observed, and eliminates the need for handling individual samples. Also during in situ flow-through analysis, a strip chart recorder can be attached to the fluorometer, simplifying data collection by providing a continuous record of the fluorescence measured. During laboratory analysis, however, the flow-through system is seldom used, since discrete samples are homogeneous and usually lack the volume needed to fill the system. Instead, the fluorometer is operated in cuvette mode, where only a small portion of a sample is required for analysis.

P.2.2.1 Each method of analysis also has its inherent problems. Laboratory analysis requires that discrete samples be collected, bottled, labeled, stored in the field, and then transported to the

laboratory; this introduces many opportunities for samples to be lost through mislabeling, misplacement, or breakage. In addition, the frequency of sampling may be insufficient to clearly define the changes in dye concentration as a function of time.

P.2.2.2 In situ analysis, on the other hand, is usually performed under adverse environmental conditions, often at a fast pace, in a cramped and unsteady work space or in less than ideal weather conditions. Thus, it is more likely that an error will occur during in situ analysis than during analysis in the controlled environment of a laboratory. It is also usually necessary to compute and apply many more temperature correction factors to fluorescence values during in situ analysis than during a laboratory analysis since the samples to be analyzed in situ have not had a chance to reach a common temperature. This also increases the chances for error during analysis. In addition, in situ analysis is usually final. That is, if questions are raised about the validity of a measurement after the analysis, no sample is available for verification. In situ analysis may not be used when significant turbidity interference occurs.

P.2.2.3 To minimize the risk involved in relying on either method alone, a combination of the two may be employed—a preliminary in situ analysis to help guide the sampling effort and a final laboratory analysis to ensure accurate results for quantitative analysis.

P.2.2.4 Regardless of when and where fluorometric analysis takes place, several general precautionary measures should be taken to ensure that the analysis is reliable.

- a. The fluorometer should be accurately calibrated.
- b. Sample contamination should be avoided by rinsing or flushing the sample chamber between readings.
- c. The fluorometer operator should have experience with the instrument that is used. Experience can be gained through practice prior to the analysis.
- d. Sample temperatures should be observed and recorded during analysis to determine the necessary fluorescence correction factors.
- e. All information used to determine concentration units should be recorded (for example, scale and meter or dial deflection).
- f. The calibration should be checked on a regular basis (every hour or so). This is especially important if the fluorometer is powered by a battery. When the battery is drained, readings are no longer accurate.

P.2.2.5 For flow-through analysis in particular, all connections between the sampling hose, fluorometer, and pump must be tight to prevent air bubbles from entering the sample chamber. Air bubbles may also be introduced by a leaky pump seal. Thus, it is recommended that the pump be connected to the system so that water is drawn up through the fluorometer to the pump. A screen placed at the intake end of the sampling hose prevents sand and pebbles from altering

the optics of the system since they may scratch the glass in the sample chamber as they travel through the system.

P.2.2.6 When analyzing samples in cuvette mode, the optics of the system may be distorted by scratches or smudges on the cuvette, making it necessary to wipe the cuvette clean prior to its insertion in the sample chamber. Once the cuvette is inside the warm sample chamber, a reading must be made quickly to prevent warming of the sample or condensation forming on the cuvette. Warming reduces fluorescence, and condensation distorts the system optics.

P.2.2.7 A person who has handled dye should never touch the fluorometer, or else he/she should use rubber gloves to handle dye and then discard them. Extremely small traces of dye on cuvettes or sample tubes can cause extremely large errors.

### P.3 Sampling.

P.3.1 Sampling equipment. The basic equipment needed to perform a dye tracer study includes the following:

a. Fluorometers and accessories (filters, spare lamps, recorders, cuvettes, and sample holders). A spare fluorometer should be included, if available, since the entire field study centers around its operation.

b. Standard dye solutions for calibrating the fluorometers.

c. Generators or 12-volt deep-cycle marine batteries (with charger) to power fluorometers and pumps if the dye concentration is to be monitored continuously.

d. Sampling equipment: pump and hoses, automatic sampler or discrete sampler (for example, a Van Dorn sampler), bottles, labels, waterproof markers.

e. Temperature-measuring device for measuring sample temperatures if the temperature of the samples being analyzed will vary significantly.

f. Dye, dilution vessels, and injection equipment (for example, bucket, pump, and hoses).

g. Description and dimensions of the containment area and surveying equipment to measure dimensions of the containment area.

h. Equipment and records to determine the flow rate of the effluent from the containment area (for example, production records, dredge discharge rate, weir length, depth of flow over the weir, and head above the weir).

i. Miscellaneous equipment (for example, life jackets and tool kits).

j. Data forms.

Additional equipment might include cameras, radios, rope, and lights. All equipment should be checked for proper performance prior to transporting to the field.

### P.3.2 Preparatory tasks.

a. Prior to conducting the dye tracer study, the average discharge rate at all points of discharge from the containment area should be measured or estimated. Equipment should be prepared, calibrated, and installed to measure or estimate the discharge rate during the dye tracer study. If production records are to be used to estimate the discharge, the discharge should be correlated to production. The average discharge rate,  $Q$ , is equal to the sum of the average discharge rate at each discharge point,  $q$ .

b. A survey of the containment area should be performed to determine the area, depth, and volume of ponding,  $V_p$ , at the site for determination of the theoretical residence time,  $T$ . The volume can be estimated from as-built or design drawings of the site, but the depth of fill and ponding should be verified in the field to ensure that an accurate estimate of the hydraulic efficiency is determined from the dye tracer study. The ponded volume is needed to estimate dye requirements. An accurate determination of the volume is not needed to determine only the mean residence time.

c. Using the average discharge rate and the ponded volume, the theoretical residence time of the site should be computed to plan the duration of the dye tracer study and to determine the hydraulic efficiency.

$$T = \frac{V_p}{Q} \quad (\text{P-1})$$

d. The background fluorescence should be measured at the site. Background fluorescence is the sum of all contributions to fluorescence by materials other than the fluorescent dye. The best method to determine the background fluorescence is to measure the fluorescence of the discharge from the site several times prior to addition of dye at the inlet. If the background fluorescence is expected to be variable, the fluorescence of supernatant from the influent should be measured before and during the dye tracer study. The fluorescence of the water at the dredging site should not be used as the background fluorescence since some of the sediment that is mixed with the site water may remain suspended and exhibit fluorescence. Similarly, the sediment may release or adsorb fluorescent materials that would alter the fluorescence of the site water.

e. The effect of turbidity on the measurement of fluorescence should be examined to determine whether the discharge samples should be filtered prior to measuring their fluorescence. Turbidity reduces the fluorescence by absorbing and scattering the light from the fluorometer lamp. Filtering is necessary only when samples are highly turbid or when the turbidity varies significantly. The effect of turbidity can be tested very simply. A sample of the discharge is divided in half, and a small amount of dye is added to one of the portions. The fluorometer is blanked or zeroed on the portion without dye in it, and the fluorescence of the portion containing dye is measured. Next, both samples are filtered or centrifuged to remove the turbidity. The process is then repeated using the filtrates or supernatants blanking the fluorometer

on the portion without dye in it and measuring the fluorescence of the portion containing dye. If the measured fluorescence of the sample without turbidity differed from the measured fluorescence of the sample with turbidity, then it is evident that turbidity affected the analysis. Alternatively, distilled water could be used as the blank when the turbidity or the background fluorescence is expected to vary significantly during the study.

### P.3.3 Dye dosage requirements.

a. Dye is usually released instantaneously as a slug in studies performed to measure the mean residence time or hydraulic efficiency of a basin. The dye marks a small parcel of water that disperses as the parcel passes through the basin. Ideally, the dispersion in a settling basin is kept very low, and the parcel moves as a slug through the basin by plug flow. In practice, the net flow-through velocity is very low, sufficiently low that the parcel would move by plug flow in the absence of external forces. However, containment areas are subject to wind forces that transform the basins into partially mixed basins, where the velocities induced by wind are much greater than the net flow-through velocity. Consequently, the flow through the basin more closely represents completely mixed conditions than plug flow conditions. Therefore, the dye requirements are determined based on the assumption that the dye is completely mixed in the basin rather than longitudinally dispersed.

b. A typical dye tracer curve for a dredged material containment area (Figure P-1) shows a residence time distribution that is characteristic of a partially mixed basin. Dye appears quickly at the discharge point at time  $t_i$  and then shortly thereafter the peak concentration is discharged at time  $t_p$ . After the peak concentration reaches the discharge point, the dye concentration quickly decreases to about 30-60% of the peak concentration, depending on the wind and the theoretical residence time of the basin. The dye concentration then gradually decreases until all of the dye is finally discharged at time  $t_f$ . The mean residence time and theoretical residence time are shown in the figure as  $t$  and  $T$ , respectively. The residence time distribution indicates that some of the water short-circuits to the discharge point before the dye is completely mixed throughout the containment area. However, the dye becomes well mixed soon after the peak concentration is discharged, and then the dye concentration decreases gradually (instead of rapidly as it did before being completely mixed) to zero.

c. Before determining the dye dosage requirements for a study, a standard calibration curve should be developed for the dye and the fluorometers to be used. This consists of plotting the fluorometer response for at least five known concentrations of dye. The design dye concentration is based on the ability to measure the dye concentration accurately for the length of the study, while not exceeding the maximum fluorometer response or excessively coloring the water.



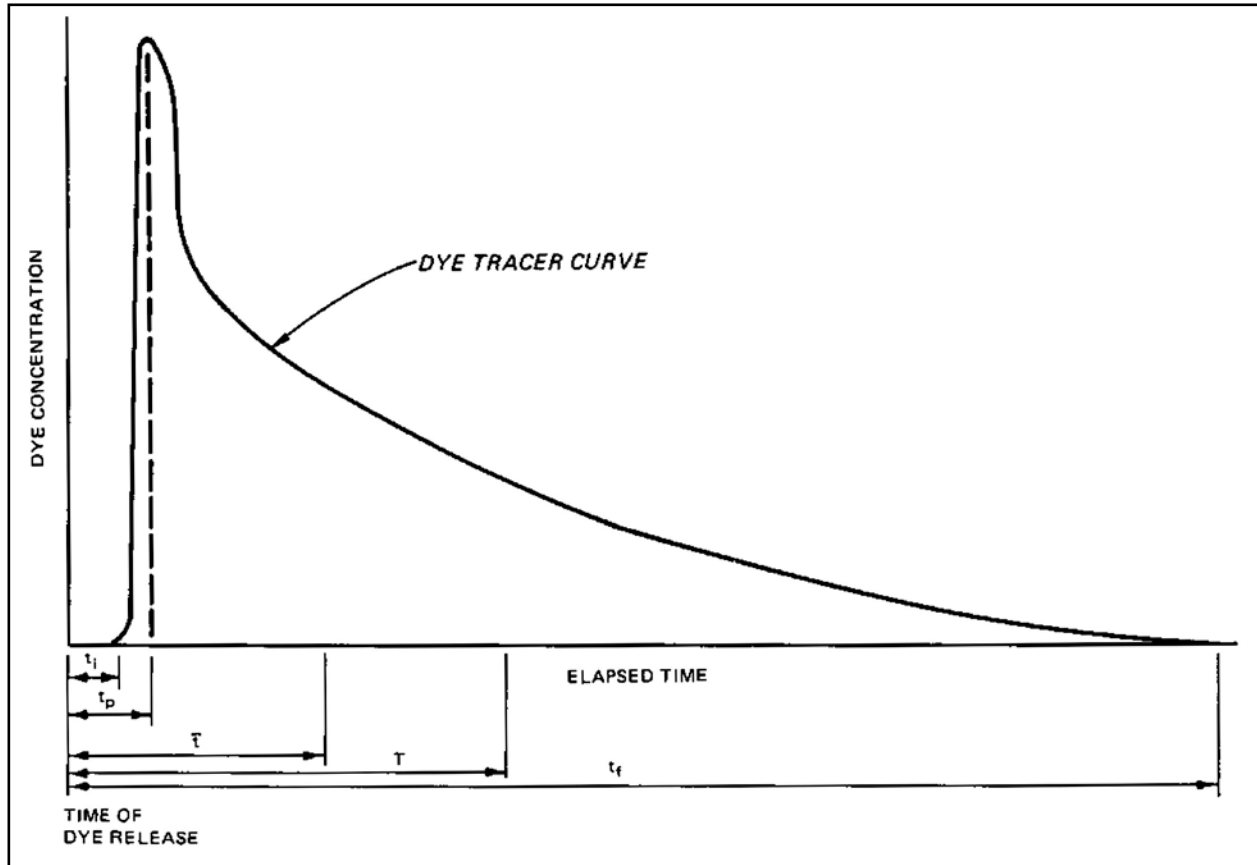

Figure P-1. A Typical Plot of the Residence Time Distribution for Dredged Material Containment Areas

d. The dye dosage requirements are based on achieving an initial concentration of 30 parts per billion (ppb) in a completely mixed basin. This concentration of Rhodamine WT corresponds to 30% of the full-scale deflection of many commonly used fluorometers. With this quantity of dye, the peak concentration will generally be less than 100 ppb (or 100% of the maximum fluorometer response) except for very small containment areas (<15 acres) or for areas with very bad channeling and short-circuiting. Since the peak concentration may exceed the capacity of the fluorometer, discrete samples should be taken during the period when the peak concentration is being discharged. These samples may be diluted to measure the peak concentration.

e. The dye dosage requirements are computed as follows:

$$\begin{aligned}
 \text{Dye Dosage, lb} &= 0.00272 (C_o, \text{ ppb})(V_p, \text{ acre-ft}) \\
 &= 6.24 \times 10^{-8} (C_o, \text{ ppb})(V_p, \text{ ft}^3) \\
 &= 2.21 \times 10^{-9} (C_o, \text{ ppb})(V_p, \text{ L})
 \end{aligned}
 \tag{P-2}$$

31 Jul 15

where

$C_o$  = desired dye concentration (generally 30 ppb for Rhodamine WT)

$V_p$  = ponded volume

Dye Dosage = quantity of pure dye to be added to containment area, pounds

f. Fluorescent dyes are not generally produced at 100% strength. For example, Rhodamine WT is typically distributed at 20% dye by weight. Consequently, the quantity of manufacturer stock dye would be five times as large as computed in Equation P-2. The stock dye dosage can be computed as follows:

$$\text{Stock Dye Dosage} = \frac{\text{Dye Dosage}}{\text{Stock Concentration}} \quad (\text{P-3})$$

where the stock concentration is the fractional dye content by weight.

g. The volume of stock dye required can be computed as follows:

$$\text{Volume of Stock Dye} = \frac{\text{Stock Dye Dosage}}{\text{Specific Weight}} \quad (\text{P-4})$$

The specific weight of liquid Rhodamine WT dye at a concentration of 20% by weight is about 1.19.

P.3.4 Dye addition. The dye should be added to the influent stream in liquid form in a quantity and manner that is easy to manage. If the dye comes in solid form, it should be dissolved prior to its addition. Solid dye is easier to transport, but it is often inconvenient to dissolve at field locations. The dye may be diluted to a volume that will ensure good mixing with the influent stream, but the quantity should not be so large that it takes more than about 5-10 min to add the dye. The dye may be pumped into the influent pipe or poured into the influent jet or pool. Greater dilutions should be used to ensure good mixing if the dye is to be poured into the influent. Care must be taken that the dye is distributed so that it flows into the containment area in the same manner that the influent does.

#### P.3.5 Sampling procedures.

a. Sampling should be conducted at all points of discharge from the containment area.

b. The dye concentration may be measured continuously at the discharge, or discrete samples may be collected throughout the test. Discrete samples must be taken when turbidity interference occurs since the samples must be filtered or centrifuged. Discrete samples should be taken when the dye is being measured continuously to provide a backup in the case of equipment malfunction and to verify the results of the continuous monitor.

c. The sampling frequency should be scheduled to observe any significant change in dye concentration (about 5-10% of the peak dye concentration). Sampling should be more frequent near the start of the test, when dye starts to exit from the containment area, and when the peak dye concentration passes the discharge points. About 40 carefully spaced samples should clearly define the residence time distribution or dye tracer curve.

d. The sampling duration should be sufficiently long to permit the dye concentration to decrease to 10% of the peak concentration or less. For planning purposes, the duration should be at least about 2.5 times the theoretical residence time.

e. The flow rate at all points of discharge from the containment area should be measured. If the flow rate varies significantly (more than 20% of average), it should be measured periodically throughout the test. Production records may be used to provide an indication of the variability of the flow rate. The flow rate over weirs may be estimated by measuring the depth of flow over the weir and the length of the weir crest and applying the weir formula for sharp-crested weirs:

$$Q = 3.3 LH^{3/2} \quad (\text{P-5})$$

or

$$Q = 2.6 Lh^{3/2} \quad (\text{P-6})$$

where

$Q$  = flow rate, ft<sup>3</sup>/sec

$L$  = weir crest length, ft

$H$  = static head above weir crest, ft

$h$  = depth of flow above weir crest, ft

#### P.4 Data Analysis.

P.4.1 Data reduction. The data should be tabulated in the following form:

Sample	Time from Dye Addition	Flow Rate	Dye Concentration Above Background	Time Interval
$I$	$t_i$	$Q_i$	$C_i$	$\Delta t_i$

a. Column 1 is the number of the sample,  $i$ . If the dye concentration was monitored continuously, discrete points on the dye concentration curve may be used as samples.

31 Jul 15

b. Column 2 is the amount of time,  $t_i$ , that elapsed between when the dye was added to the influent and when the sample was taken from the effluent.

c. Column 3 is the flow rate,  $Q_i$ , at the time the sample was taken. The flow rate is needed only when it is not constant during the test.

d. Column 4 is the dye concentration of the sample discounted for the background fluorescence,  $C_i$ ; that is

$$C_i = C_{si} - C_{bi} \quad (\text{P-7})$$

where

$C_i$  = dye concentration discounted for background fluorescence of sample  $i$

$C_{si}$  = measured fluorescence of sample  $i$

$C_{bi}$  = background fluorescence at time  $t_i$

If the background fluorescence does not vary,  $C_{bi}$  is a constant, and it may be eliminated from the expression for calculating  $C_i$  if the fluorometer is blanked or zeroed with the site water.

e. Column 5 is the interval of time,  $\Delta t_i$ , over which the sample is representative of the results. The value of this interval is one-half of the interval between the times when the samples immediately preceding and following the sample of interest were taken.

$$\Delta t_i = \frac{t_{i+1} - t_{i-1}}{2} \quad (\text{P-8})$$

where

$\Delta t_i$  = time interval over which sample  $i$  is representative

$t_{i+1}$  = time when the following sample was taken

$t_{i-1}$  = time when the preceding sample was taken

A data table is produced for each point of discharge.

#### P.4.2 Determination of mean residence time.

a. After generating the data tables, the mean residence time is computed as follows:

$$\bar{t} = \frac{\sum_{i=0}^n t_i C_i Q_i \Delta t_i}{\sum_{i=0}^n C_i Q_i \Delta t_i} \quad (\text{P-9})$$

where

$t$  = mean residence time

$n$  = total number of samples

b. If the flow rate is nearly constant throughout the test, the equation may be simplified to

$$\bar{t} = \frac{\sum_{i=0}^n t_i C_i \Delta t_i}{\sum_{i=0}^n C_i \Delta t_i} \quad (\text{P-10})$$

c. If the sampling interval is constant (that is,  $\Delta t_i = \text{constant}$ ) but the flow rate is not, the equation may be simplified to:

$$\bar{t} = \frac{\sum_{i=0}^n t_i C_i q_i}{\sum_{i=0}^n C_i q_i} \quad (\text{P-11})$$

d. If both the sampling interval and the flow rate are constant, the equation may be simplified to

$$\bar{t} = \frac{\sum_{i=0}^n t_i C_i}{\sum_{i=0}^n C_i} \quad (\text{P-12})$$

## P.4.3 Determination of hydraulic efficiency.

a. The hydraulic efficiency is the ratio of the mean residence time to the theoretical residence time where

$$\text{Hydraulic Efficiency} = \frac{\bar{t}}{T} \quad (\text{P-13})$$

b. The correlation factor for containment area volume requirements is equal to the reciprocal of the hydraulic efficiency. This correction is applied by multiplying the volume by the correction factor.

Hydraulic Efficiency Correction

$$\text{Factor for Volume Requirements} = \frac{1}{\text{Hydraulic Efficiency}} \quad (\text{P-14})$$

## GLOSSARY

## Abbreviations

AASHTO	American Association of State Highway and Transportation Officials
AC	Alternating Current
ADCIRC	Advanced CIRCulation model
ADCP	Acoustic Doppler Current Profiler
ADDAMS	Automated Dredging and Disposal Alternatives Modeling System
ADMODUS	Advanced MODular Ultrasound System
ALMO	Automatic Light Mixture Overboard
APHA	American Public Health Association
ASCE	American Society of Civil Engineers
ASCII	American Standard Code for Information Exchange
ASTM	American Society for Testing and Materials; American Soils Testing Manual
BBADCP	Broadband Acoustic Doppler Current Profiler
BRAT	Benthic Resources Assessment Technique
CAD	Contained Aquatic Disposal
CAIS	Center for Applied Isotope Studies
CAMP	Comprehensive Analysis of Migration Pathways
CDF	Confined Disposal Facility; CDF Design Module (ADDAMS application)
CDFATE	(Computation of Mixing Zone Size or Dilution for) Continuous Discharges Fate
CEC	Cation Exchange Capacity
CEDEP	Cost Estimating Dredge Estimating Program
CEERD	U.S. Army Engineer Research and Development Center
CEERD-EP	U.S. Army Engineer Research and Development Center, Environmental Laboratory
CEERD-EP-E	U.S. Army Engineer Research and Development Center, Environmental Laboratory, Environmental Engineering Branch
CEERD-EP-R	U.S. Army Engineer Research and Development Center, Environmental Laboratory, Environmental Risk Assessment Branch
CEERD-EP-W	U.S. Army Engineer Research and Development Center, Environmental Laboratory, Water Quality and Contaminant Modeling Branch
CEFMS	U. S. Army Corps of Engineers Financial Management System

CEMVN	U.S. Army Corps of Engineers, Mississippi Valley Division, New Orleans District
CESAM	U.S. Army Corps of Engineers, South Atlantic Division, Mobile District
CESPN	U. S. Army Corps of Engineers, South Pacific Division, San Francisco District
CEWRC-HEC	U.S. Army Corps of Engineers, Water Resources Support Center, Hydrologic Engineering Center
CH	inorganic Clay of High plasticity (USCS classification)
CHARTS	Compact Hydrographic Airborne Rapid Total Survey
CE-Dredge	U.S. Army Corps of Engineers-Dredge
CFR	Code of Federal Regulations
CHL	Coastal & Hydraulics Laboratory (U.S. Army Corps of Engineers, Engineer Research & Development Center)
CIRP	Coastal Inlets Research Program
CL	CLay (USCS classification)
CMS	Coastal Modeling System
CMS-Wave	Costal Modeling System Wave
CoP	Community of Practice
CORMIX	CORnell MIXing Zone Expert System
CPF	Confined Placement Facility
CPT	Cone Penetration Test
CS <sup>3</sup>	Continuous Sediment Sampling and Analysis System
CTD	Conductivity, Temperature, and Depth/pressure
CWA	Clean Water Act
D2M2	System Cost Optimization of Regional Dredging and Dredged Material Disposal (ADDAMS application)
DARM	Disposal Area Reuse Management
DC	Direct Current
dbh	Diameter Breast Height
DGPS	Differential Global Positioning System
DIFID	DISposal From an Instantaneous Dump
DIG	Dredging Innovations Group
DMF	Decision-Making Framework
DMM	Dredged Material Management



DMMP	Dredged Material Management Plan
DMRP	Dredged Material Research Program
DO	Dissolved Oxygen
DOD	Department of Defense
DOER	Dredging Operations and Environmental Research Program
DOS	Disk Operating System
DOT	Department of Transportation
DOTS	Dredging Operations Technical Support Program
DQM	National Dredging Quality Management Program
DQMOBS	Dredging Quality Management On-Board Software
DROPMIX	Dredging Operations Mixing Zone Model
DRP	Dredging Research Program
DTPA	Diethylenetriaminepentaaceticacid
DYECON	Determination of Hydraulic Retention Time and Efficiency of Confined Disposal Facilities (ADDAMS application)
E2-D2	Environmental Effects and Dredging and Disposal (DOTS literature database)
EA	Environmental Assessment
EC	Engineering Circular
eCoastal	Enterprise Coastal
EEDP	Environmental Effects of Dredging Program
EFQUAL	Effluent (Water) Quality (ADDAMS application)
eGIS	Enterprise Geographic Information System
Eh	Redox potential
EIS	Environmental Impact Statement
EM	Engineer Manual
EP	Engineering Pamphlet
EPA	Environmental Protection Agency
ER	Engineer Regulation
ERDC	U.S. Army Engineer Research and Development Center
ERP	Environmental Resources Protection
ESD	Environmental Services Division (U.S. Environmental Protection Agency)
ESTCP	Environmental Security Technology and Certification Program
ETL	Engineer Technical Letter

FDA	Food and Drug Administration
FONSI	Finding of No Significant Impact
FTU	Formazin Turbidity Units
FVP	Field Verification Program
FWS	U.S. Fish and Wildlife Service
FY	Fiscal Year
g/L	Grams per Liter
GFC	Geosynthetic Fabric Container
GIMS	Gamma Isotope Mapping System
GIMS/ CS <sup>3</sup>	Gamma Isotope Mapping System/Continuous Sediment Sampling System
GIS	Geographic Information System
GPS	Global Positioning System
GUI	Graphical User Interface
ha	hectare (about 2.5 acres)
HEC	U.S. Army Engineer Hydrologic Engineering Center
HECF	Hydraulic Efficiency Correction Factor
HELP	Hydrologic Evaluation of Landfill Performance
HELPQ	Hydraulic Evaluation of Leachate Production and Leachate and Quality
HQUSACE	Headquarters, U.S. Army Corps of Engineers
HRDP	High Resolution Density Profiler
IAG	Interagency Agreement
ID	Inside Diameter
IT	Innovative Technologies
ITM	Inland Testing Manual
JALBTCX	Joint Airborne Lidar Bathymetry Technical Center of Expertise
KGME	Potassium Glyme Methoxy Ethanol
kHz	kiloHertz
LAT-E	Laboratory Analysis of Toxicity (for CDF) Effluent (to Compute LC50) (ADDAMS application)
LAT-R	Laboratory Analysis of Toxicity (for CDF) Runoff (to Compute LC50) (ADDAMS application)
LBC	Level-Bottom Capping
LEDO	Long-Term Effects of Dredging Operations

LL	Liquid Limit
LPC	Limiting Permissible Concentration
LSCRS	Large Strain, Controlled Rate of Strain
LSST	Laser In Situ Scattering and Transmissometry
LTMS	Long-Term Management Strategy
MDFATE	Multiple Disposal Fate (of Dredged Material in Open Water)
MEC	Munitions and Explosives of Concern
mg/L	milligrams per Liter
MHHW	Mean High High Water
MOU	Memorandum of Understanding
MPRSA	Marine Protection, Research, and Sanctuaries Act
NAVOCEANO	U.S. Naval Oceanographic Office
NCDB	Navigation and Coastal Data Bank
NDC	Navigation Data Center
NEPA	National Environmental Policy Act
NM	Nautical Mile
NMFS	National Marine Fisheries Service
NOAA	National Oceanic and Atmospheric Administration
NRC	National Research Council; Nuclear Regulatory Commission
NRCS	Natural Resources Conservation Service
NRCTRB-MB	National Research Council's Transportation Research Board-Marine Board
nT	nanoTesla
NTU	Nephelometric Turbidity Units
NWP	Nationwide Permit
NWS	U.S. National Weather Service
O&M	Operations and Maintenance
OBS	Optical Back Scatter
ODD	Ocean Disposal Database
ODMDS	Ocean Dredged Material Disposal Site
OERR	Office of Emergency and Remedial Response
OMBIL	Operations and Management Business Information Link
OSHA	Occupational Safety and Health Administration

OTM	Ocean Testing Manual
PAH	Polycyclic Aromatic Hydrocarbons
PC	Personal Computer
PCB	Polychlorinated byphenyl
PCDDF	Primary Consolidation and Desiccation of Dredged Fill
PDF	Portable Document Format
PGL	Policy Guidance Letter
PI	Plasticity Index
PIANC	Permanent International Association of Navigation Congresses
PL	Plastic Limit; Public Law
PLUMES	PLUmes MEasurement System
ppt	parts per thousand
PROSPECT	PROponent-Sponsored Engineer Corps Training
PSDDF	Primary consolidation, Secondary compression, and Desiccation of Dredged Fill (ADDAMS application)
PTM	Particle Tracking Model
PUP	Prediction of contaminant Uptake by freshwater Plants (ADDAMS application)
PVC	PolyVinyl Chloride
R&D	Research and Development
RCI	Rating Cone Index
RCRA	Resource Conservation and Recovery Act
RGB	Red, Green, Blue
rpm	Revolutions Per Minute
RQD	Rock Quality Designation
RSM	Regional Sediment Management
RUC	Riverine Utility Craft
RUNQUAL	(Comparison of Predicted) RUNoff (Water) QUALity (with Standards) (ADDAMS application)
S/S	Solidification/Stabilization
SAM	South Atlantic Division, Mobile District (U.S. Army Corps of Engineers)
SAVEWS	Submersed Aquatic Vegetation Early Warning System
SDS	Spatial Data Standards

SETTLE	Design of Confined Disposal Facilities for Suspended Solids Retention and Initial Storage Requirements (ADDAMS application)
SHOALS	Scanning Hydrographic Operational Airborne Lidar Survey
SI	Silent Inspector (obsolete; see DQM); International System of Units
SMS	Surface water Modeling System
SPT	Standard Penetration Test
SS	Suspended sediment
STFATE	Short-Term Fate (of Dredged Material Disposal in Open Water)
STWAVE	STeady STate spectral Wave
TBP	Theoretical Bioaccumulation Potential
TDS	Tons Dry Solids
TM	Technical Manual
TOC	Total Organic Carbon
TSS	Total Suspended Solids
TVA	Tennessee Valley Authority
UCS	Unconfined Compressive Strength
USCS	Unified Soil Classification System
USACE	United States Army Corps of Engineers
USAEDH	United States Army Engineer Division, Huntsville
USC	United States Code
USCG	United States Coast Guard
USCS	Unified Soil Classification System
USDA	United States Department of Agriculture
USDOT	United States Department of Transportation
USEPA	United States Environmental Protection Agency
USFWS	United States Fish and Wildlife Service
USGS	United States Geological Survey
UTC	Coordinated Universal Time
UTM	Upland Testing Manual
UU	Undrained Unconsolidated
UV	UltraViolet light
UXO	Unexploded Ordnance
WABED	Wave-Action Balance Equation with Diffraction

EM 1110-2-5025

31 Jul 15

WES	U.S. Army Engineer Waterways Experiment Station
WID	Water Injection Dredge; Water Injection Dredging
WQS	Water Quality Standard
WRP	Wetlands Research Program
WRDA	Water Resources Development Act
XMDF	eXtensible Model Data Format
ZSF	Zone of Siting Feasibility