

US Army Corps
of Engineers

EM 1110-2-1003
30 November 2013

ENGINEERING AND DESIGN

Hydrographic Surveying

ENGINEER MANUAL

EM 1110-2-1003
30 Nov 13

THIS PAGE INTENTIONALLY LEFT BLANK

Engineering and Design
HYDROGRAPHIC SURVEYING

1. Purpose. This manual provides technical guidance for specifying requirements and performing hydrographic surveys of USACE river and harbor navigation projects, water control projects, and shore protection projects.
2. Applicability. This manual applies to all USACE commands having responsibility for civil works navigation, dredging, flood risk management, multi-purpose water supply/control, coastal storm damage reduction, hurricane protection, and hydropower projects.
3. Distribution Statement. This publication is approved for public release; distribution is unlimited.
4. Discussion. Hydrographic surveys are performed to provide underwater site plan data for nearly all USACE civil works activities. These projects primarily include channel condition, measurement, payment, and clearance surveys of coastal Federal navigation channels, inland river and intracoastal navigation projects, reservoirs, and underwater structural surveys at locks and dams. Also included are surveys for various coastal engineering projects, beach renourishment and restoration projects, shoreline protection structure construction (breakwaters and jetties), and river stabilization structures. Hydrographic survey systems developed during the past decade have become increasingly complex, requiring the integration of acoustic multibeam sonar systems with differential GPS positioning systems and inertial vessel orientation/alignment systems. Acoustic depth measurements now utilize sophisticated beam forming phase detection, interferometric, synthetic aperture, and backscatter signal processing methods. The quality control and quality assurance guidance in this manual is intended to increase the overall confidence in reported navigation project clearances and the measured elevations of water control and shore protection projects.

FOR THE COMMANDER:

18 Appendixes
(See Table of Contents)

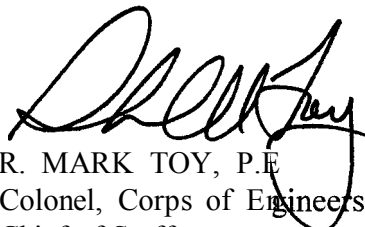
R. MARK TOY, P.E.
Colonel, Corps of Engineers
Chief of Staff

EM 1110-2-1003
30 Nov 13

THIS PAGE INTENTIONALLY LEFT BLANK

Engineering and Design
HYDROGRAPHIC SURVEYING

TABLE OF CONTENTS

	<u>Paragraph</u>	<u>Page</u>
Chapter 1. Introduction		
Purpose	1-1	1-1
Applicability	1-2	1-1
Distribution	1-3	1-1
References	1-4	1-1
Discussion	1-5	1-1
Abbreviations and Acronyms	1-6	1-1
Hydrographic Survey Support to Corps Civil Works Activities..	1-7	1-1
Use and Scope of Manual	1-8	1-3
Hydrographic Surveying Requirements during Project Phases ...	1-9	1-4
Geospatial Data Policy	1-10	1-4
Metrics	1-11	1-5
Trade Name Exclusions	1-12	1-5
Manual Development	1-13	1-5
Proponency	1-14	1-6
Chapter 2. Overview of Hydrographic Surveys for Civil Works Navigation and Water Control Projects		
Required Supplemental References	2-1	2-1
Section I: Overview of Hydrographic Survey Techniques		
General Hydrographic Survey Methods	2-2	2-1
Survey Coverage Options	2-3	2-2
Survey Line Spacing and Alignment Specifications	2-4	2-3
Horizontal Positioning Methods and Datum Specifications	2-5	2-5
Vertical Datum Specifications	2-6	2-6
Water Surface Elevation Measurement Specifications	2-7	2-6
Vessel Motion and Orientation Requirements	2-8	2-7
Quality Control and Quality Assurance	2-9	2-8
Miscellaneous Survey Requirements	2-10	2-8

	<u>Paragraph</u>	<u>Page</u>
Section II: General Planning Considerations		
General.....	2-11	2-9
Determining Project Accuracy Requirements.....	2-12	2-11
Determining Required Data Density.....	2-13	2-12
Section III: Vessel Selection Considerations		
General Considerations.....	2-14	2-13
Vessel and Equipment Acquisition.....	2-15	2-15
Section IV: Data Processing, Editing, Depth Selection, and Plotting Options		
Hydrographic Data Processing Flow	2-16	2-15
Initial Field Data Review and Editing	2-17	2-16
Office Data Editing and Processing.....	2-18	2-17
Depth Selection Options.....	2-19	2-18
Hard Copy Plot Options	2-20	2-20
Selecting Representative Depths on Plan Drawings.....	2-21	2-21
Terrain Modeling	2-22	2-22
Data Submittal to District Office Project/Design Engineer	2-23	2-22
Retention of Hard-Copy Depth Records	2-24	2-23
Section V: Estimating Costs for Hydrographic Surveys of Navigation Projects		
Factors to Consider in Estimating Survey Time	2-25	2-23
Plant Rental Rates	2-26	2-25
Crew Labor Rates.....	2-27	2-25
Effective Daily Field Survey Crew Rates	2-28	2-25
Survey Time and Cost Estimates	2-29	2-25
Section VI: Decision Matrix: Single Beam v Multibeam Surveys		
Chapter 3. Recommended USACE Accuracy Standards for Federal Navigation Projects		
Purpose and Scope	3-1	3-1
Discussion.....	3-2	3-2
Quality Assurance Performance Tests	3-3	3-2
Total Propagated Uncertainty Accuracy Estimates	3-4	3-4
Recommended USACE Depth Accuracy Standards for Engineering and Construction Surveys.....	3-5	3-4
Horizontal Accuracy Standards.....	3-6	3-7
IHO Standards for Hydrographic Surveys.....	3-7	3-7

	<u>Paragraph</u>	<u>Page</u>
Chapter 4. Single Beam Depth Measurement Systems		
General Scope and Applications	4-1	4-1
References.....	4-2	4-1
Section I: Principles of Acoustic Single Beam Depth Measurement		
Overview	4-3	4-1
Single Beam Transducer and Frequency Specifications.....	4-4	4-3
Echo-Sounder Control Settings	4-5	4-5
Single Beam Power and Receiver Sensitivity Effects	4-6	4-7
Section II: Single Beam Echo Sounders and Auxiliary Sensors		
Single Beam Echo Sounding Evolution in USACE.....	4-7	4-9
Single Beam Transducer Mounting Locations	4-8	4-10
Motion Correction on Single Beam Systems--Vessel Heave, Roll, Pitch, and Yaw	4-9	4-10
Section III: Single Beam Quality Control Calibrations		
Bar Check Calibration of Single Beam Echo Sounders.....	4-10	4-15
Depth Corrections Based on Bar Check Data	4-11	4-20
Velocity Meter Calibration	4-12	4-24
Squat and Settlement Calibration	4-13	4-27
Vessel Dynamic Draft Calibrations.....	4-14	4-29
Latency Calibrations	4-15	4-29
Section IV: Data Collection, Editing, and Processing		
Single Beam Survey Methods	4-16	4-30
Depth Collection Density and Bottom Coverage	4-17	4-30
Field Collection of Single Beam Survey Data.....	4-18	4-33
Editing and Processing Single Beam Data	4-19	4-34
Depth Selection and Thinning Options on Single Beam Data ...	4-20	4-34
Section V: Single Beam System Quality Assurance Performance Tests		
Depth Quality Assurance Techniques for Single Beam Surveys	4-21	4-36
Section VI: Summary of Quality Control and Quality Assurance Criteria for Single Beam Surveys		

	<u>Paragraph</u>	<u>Page</u>
Chapter 5. Multiple Transducer Channel Sweep Systems for Shallow Draft Navigation Projects		
General Overview.....	5-1	5-1
Background.....	5-2	5-1
Design of Channel Sweep Systems.....	5-3	5-2
General Survey Operation	5-4	5-4
Multiple Transducer System Quality Control and Quality Assurance.	5-5	5-5
Selecting Recorded Depths and Estimated Accuracies.....	5-6	5-8
Section I: Examples of Corps Multiple Transducer Survey Systems		
Mobile District Tuscaloosa Site Office Sweep Systems.....	5-7	5-9
St. Louis District Ross 875-4 Shallow Water Portable Sweep System.....	5-8	5-12
New York District Sweep System.....	5-9	5-13
St. Paul District Sweep System	5-10	5-13
Rock Island District Sweep System	5-11	5-15
Philadelphia District Sweep System.	5-12	5-15
Jacksonville District Raytheon 719 CSS (Channel Sweep System).....	5-13	5-16
Detroit District 120-Ft Strike Detection Systems.	5-14	5-16
Section II: Recommended Quality Control Checklist for Multiple Transducer Sweep Systems		
Chapter 6. Acoustic Multibeam Survey Systems		
General Scope and Applications	6-1	6-1
Background.....	6-2	6-1
General USACE Applications.....	6-3	6-2
Section I: Principles of Multibeam Depth Measurement		
General	6-4	6-2
Depth Measurement Principles.....	6-5	6-2
Overall System Requirements	6-6	6-7
References.....	6-7	6-8

	<u>Paragraph</u>	<u>Page</u>
Section II: Multibeam Applications and Utilization on USACE Civil Works Projects		
General	6-8	6-9
Project Condition Surveys	6-9	6-9
Dredging Measurement and Payment Surveys.....	6-10	6-9
Shoal or Strike Detection Applications.....	6-11	6-10
Underwater Structure Investigation Surveys.....	6-12	6-11
Multibeam Sidescan Imagery	6-13	6-11
Miscellaneous Considerations	6-14	6-11
Section III: Configuring Multibeam Transducers on Corps Floating Plant		
General	6-15	6-12
Fixed Hull-Mounted Systems.....	6-16	6-13
Through-Hull Transducer Mountings	6-17	6-14
Bow-Mounted Transducers	6-18	6-14
Side Mounted Transducers	6-19	6-15
Stern-Mounted Multibeam Transducers	6-20	6-20
Section IV: Quality Control Procedures for Multibeam Systems		
Background.....	6-21	6-22
Initial Installation Alignment and Static Offset Measurements .	6-22	6-23
Vessel Squat/Settlement, Draft, and Datum Variations.....	6-23	6-26
Patch Test (Residual Bias Calibration)	6-24	6-26
Velocity Measurements.....	6-25	6-30
Vessel Draft and Index Measurements (Bar Checks)	6-26	6-32
Beam Width Restrictions on Multibeam Systems.....	6-27	6-33
Section V: Multibeam Survey Data Collection, Editing, and Processing		
Determining Coverage and Overlap.....	6-28	6-34
Editing and Processing Multibeam Data.....	6-29	6-36
Editing and Filtering Data.....	6-30	6-37
Thinning and Binning Multibeam Datasets	6-31	6-38
Recommended Bin Sizes and Depth Selection for USACE Navigation Surveys	6-32	6-38
Depth Selection Options from Binned Multibeam Data	6-33	6-39

	<u>Paragraph</u>	<u>Page</u>
Section VI: Quality Assurance Performance Tests on Multibeam Systems		
General	6-34	6-39
Performance Test Procedures	6-35	6-42
Multibeam versus Single Beam Performance Tests.....	6-36	6-45
Real-time Quality Assurance Tests	6-37	6-45
Sample Performance Test—Survey Vessel Shuman (Philadelphia District)	6-38	6-45
Fixed Calibration Barge (Louisville District)	6-39	6-46
SECTION VII: Summary of Multibeam QC and QA Criteria		
Chapter 7. GPS Positioning, Orientation, and Water Surface Elevation Measurement		
Purpose	7-1	7-1
Scope	7-2	7-1
Required References	7-3	7-1
GPS Background and Applications in USACE	7-4	7-2
GPS Accuracies	7-5	7-3
Reference Datums	7-6	7-3
Section I: Code Phase Differential GPS Positioning		
Real-Time Code Phase DGPS	7-7	7-3
USCG Code Phase DGPS Radiobeacon Navigation Service	7-8	7-4
Commercial Differential Navigation and Positioning Systems	7-9	7-5
Position Quality Control Tolerance Checks	7-10	7-7
Section II: Real-Time Kinematic Carrier Phase GPS Positioning		
Real-Time Kinematic (RTK)	7-11	7-8
RTK System Requirements	7-12	7-9
Real-Time Networks (RTN)	7-13	7-10
Inertial-Aided Post-Processed Kinematic (IAPPK)		
Position and Elevation Computations	7-14	7-10
Section III: RTK Water Surface Elevation Measurement		
RTK Surface Elevation Requirements in		
Coastal Navigation Projects.....	7-15	7-12
RTK Tide Corrections.....	7-16	7-13
Heave Correction Options from RTK Measurements.....	7-17	7-16
KTD File Generation from VDatum	7-18	7-16

	<u>Paragraph</u>	<u>Page</u>
Section IV: Vessel Motion and Orientation Measurement		
Motion Reference Units (MRUs)	7-19	7-17
Inertial Aided GPS Motion Measurement	7-20	7-18
Vessel Heave Corrections and Considerations	7-21	7-20
Recommended Quality Control Criteria for GPS Positioning Methods	7-22	7-22
Chapter 8. Coastal Navigation Project Channel Condition Surveys		
Purpose	8-1	8-1
Scope	8-2	8-1
References	8-3	8-1
Overview	8-4	8-2
Condition Survey Standards and Specifications	8-5	8-2
Topographic Feature Standards for Condition Surveys	8-6	8-3
Hard Copy Map Scales and Formats	8-7	8-4
Feature Content and Digital Data File Standards	8-8	8-7
Internet Posting of Project Condition Surveys	8-9	8-7
Channel Framework Data	8-10	8-8
Channel Condition Survey Drawing Notes	8-11	8-8
Tabular Channel Condition and Controlling Depth Reports	8-12	8-10
HYPACK Channel Condition Reporter (CCR)	8-13	8-11
Chapter 9. Surveys of Navigable Inland Rivers, Locks and Dams, River Stabilization Structures, and Reservoir Surveys		
General Applications	9-1	9-1
Survey Equipment, Vessels, and Methods	9-2	9-2
Inland River Charting Surveys	9-3	9-4
River Lock and Dam Investigation Surveys	9-4	9-6
River Stabilization Structure Surveys	9-5	9-8
Underwater Structure and Revetment Surveys	9-6	9-8
Levee Breach Surveys	9-7	9-9
Mississippi River Sand Wave Mapping	9-8	9-9
Section I: Hydrographic Surveys for River Hydraulics Studies		
Background	9-9	9-11
Cross-Sections for Hydraulic Studies	9-10	9-12
Hydraulic Engineering Guidance on Cross-Section Locations	9-11	9-16
Hydraulic Cross-Sections Adjacent to Bridges or Culverts	9-12	9-18
Required Accuracy of Hydraulic Cross-Section Data	9-13	9-20

	<u>Paragraph</u>	<u>Page</u>
Section II: Hydrographic Surveys of Reservoirs and other Impounded Areas		
Reservoir Surveys.....	9-14	9-22
Surveys of an Earth and Rockfill Dam.	9-15	9-27
Section III: Summary of Recommended Accuracy and Performance Standards for Inland Surveys		
Chapter 10. Construction Dredging Measurement, Payment, and Clearance Surveys		
General Scope.....	10-1	10-1
Background.....	10-2	10-1
Types of Dredging Support Surveys.....	10-3	10-2
Dredge Contracting and Production Measurement Methods	10-4	10-4
Definitions of Dredging Grades	10-5	10-6
Factors Impacting Survey Coverage and Accuracy Requirements.....	10-6	10-8
Measurement, Payment, and Acceptance Survey Contract Specifications	10-7	10-9
Measurement and Payment Surveys Performed by Other than Corps Hired-Labor.....	10-8	10-11
Section I: Channel Clearance Surveys		
Definitions.....	10-9	10-12
Channel Clearance Bar Sweeps.....	10-10	10-13
Acoustic Evaluation of Clearances on Dredging Projects	10-11	10-16
Evaluating Clearance Grades in Unconsolidated Material	10-12	10-23
Side Scan Sonar.....	10-13	10-23
Combined Uncertainty and Bathymetry Estimator (CUBE)	10-14	10-23
Section II: Dredge Payment Volume Calculations		
Dredge Quantity Computation Techniques—Background.....	10-15	10-25
Average End Area Method	10-16	10-26
Surface Differencing Methods—“TIN Models”	10-17	10-27
Grid or Bin Vertical Projection Methods.....	10-18	10-27
Average End Area Computation	10-19	10-27
Reference Surfaces and Payment Templates used in Corps.....	10-20	10-28

	<u>Paragraph</u>	<u>Page</u>
Section III: Average End Area Computation Methods		
Background.....	10-21	10-30
Box Cut Allowance.....	10-22	10-31
Cross-Section End Area and Volume Computations.....	10-23	10-33
HYPACK Average End Area Dredge Volume Computations...	10-24	10-36
Average End Area Computations on Irregular Channels or Non-Parallel Sections.....	10-25	10-41
Section IV: Surface Differing Volume Computations (Triangulated Irregular Networks)		
Background.....	10-26	10-44
Computing Dredge Volumes from TIN Models.....	10-27	10-47
Overdepth Dredging Statistics (HYPACK DREDGESTATS) ..	10-28	10-57
Evaluation of Dredge Quantity Estimates Based on Depth Accuracy and Density.....	10-29	10-57
Section V: Recommended Guidance for Dredging Surveys and Quantity Computations		
Recommended Dredge Quantity Computation Procedures.....	10-30	10-63
Contract Guide Specifications for Multibeam Measurement and Payment.....	10-31	10-64
Chapter 11. Coastal Engineering Surveys for Beach Renourishment Projects and Shoreline Protection Structures		
Introduction.....	11-1	11-1
Required Supplemental Reference.....	11-2	11-1
General Procedures.....	11-3	11-2
Section I: Coastal Engineering Survey Techniques		
Differential Leveling Methods.....	11-4	11-7
Total Station Methods.....	11-5	11-9
Real Time Kinematic GPS Methods.....	11-6	11-10
Coastal Research Amphibious Buggy (CRAB).....	11-7	11-11
Survey Sled Methods.....	11-8	11-12
Nearshore and Offshore Profile		
Acoustic Measurement Methods.....	11-9	11-13
LIDAR Bathymetry and Topography Methods.....	11-10	11-15
Section II: Coastal Project Applications		
Beach Renourishment Measurement and Payment Surveys.....	11-11	11-17
Offshore Jetty, Breakwater, and Groin Surveys.....	11-12	11-20
Subsurface Probings.....	11-13	11-23

	<u>Paragraph</u>	<u>Page</u>
Offshore Confined Placement or Borrow Area Surveys.....	11-14	11-26
 Section III: General Guidance on Survey Requirements for Coastal Engineering Studies		
Coastal Engineering Studies.....	11-15	11-28
Accuracy Requirements for Studies.....	11-16	11-30
Data Density, Formats, Processing and Archiving	11-17	11-30
Coastal Processes Affecting Surveys.....	11-18	11-31
Overview of Coastal Processes	11-19	11-32
Profile Closure.....	11-20	11-35
Tides and Other Water Level Changes	11-21	11-35
Survey Planning Considerations	11-22	11-36

<u>Appendices</u>	<u>Page</u>
A	References.....A-1
B	Manual Depth Measurement Techniques.....B-1
C	Contracted Survey Procedures and Cost Estimates.....C-1
D	General Background on Hydrographic Survey Accuracy Estimates.....D-1
E	IHO Standards for Hydrographic Surveys (S-44).....E-1
F	Multibeam Quality Control and Quality Assurance Procedures (North Atlantic Division Multibeam User Group).....F-1
G	Terrestrial (Non-GPS) Positioning Methods.....G-1
H	Kings Bay Entrance Channel Tidal Modeling for RTK Surveys (Jacksonville District).....H-1
I	Implementation of Inertial-Aided Post-Processed Kinematic GPS Cape Canaveral, FL (Jacksonville District).....I-1
J	Field Survey Report: Project Condition Survey Tampa Harbor, Egmont Bar Channel and Mullet Key Channel (Jacksonville District).....J-1
K	Channel Framework Data for Coastal Navigation Projects.....K-1
L	Almond Lake Reservoir Survey and Area Capacity Curves (Baltimore District).....L-1
M	2010 Allegheny River Multibeam/Side Scan Sonar Scour Survey (Pittsburgh District).....M-1
N	Application Examples of Underwater Structural Investigation Surveys.....N-1
O	Howard Hanson Dam Monitoring Survey Report-Seattle District.....O-1
P	Depth Measurement and Construction Payment in Unconsolidated Material.....P-1
Q	Navigation Project Object Detection--Side Scan Sonar.....Q-1
	Glossary.....Glossary-1

EM 1110-2-1003
30 Nov 13

THIS PAGE INTENTIONALLY LEFT BLANK

CHAPTER 1

Introduction

1-1. Purpose. This manual provides technical guidance for specifying requirements and performing hydrographic surveys of USACE river and harbor navigation projects, water control projects, and shore protection projects.

1-2. Applicability. This manual applies to all USACE commands having responsibility for civil works navigation, flood risk management, multi-purpose water supply/control, coastal storm damage reduction, hurricane protection, multi-purpose water supply/control, and hydropower projects.

1-3. Distribution. This publication is approved for public release; distribution is unlimited.

1-4. References. Referenced USACE publications and related bibliographic information are listed in Appendix A. Where applicable, primary source material for individual chapters may be noted within that chapter. Any required supplemental references are noted in each chapter.

1-5. Discussion. Hydrographic surveys are performed to provide underwater site plan data in support of nearly all USACE civil works activities. These support surveys include periodic condition assessments of coastal Federal navigation channels, inland rivers, intracoastal navigation projects, water control reservoirs, and underwater structural surveys at locks and dams. Also included are surveys that support various coastal engineering studies, beach renourishment and restoration construction, shoreline protection structure construction (breakwaters and jetties), and river stabilization structures. Hydrographic survey systems developed during the past decade have become increasingly complex, requiring the integration of acoustic multibeam (swath) sonar systems with carrier-phase GPS positioning systems and inertial vessel orientation/alignment systems. Acoustic depth measurements now employ sophisticated beam forming phase detection, interferometric, synthetic aperture, and backscatter signal processing methods. To reflect these newer developments, this manual establishes recommended accuracy and quality control standards to ensure uniform hydrographic surveying products; especially for construction dredging measurement, payment, and channel clearance assessment. The guidance in this manual is intended to enhance the equitability of contracted construction administration, and increase the overall quality and confidence in reported clearance or protection elevations in federal navigation and related shore protection or water control projects.

1-6. Abbreviations and Acronyms. Abbreviations and acronyms used in this manual are listed in the Glossary. Some abbreviations may be spelled out in each chapter for clarity.

1-7. Hydrographic Survey Support to Corps Civil Works Activities. Hydrographic surveying activities covered in this manual supports a wide range of civil works engineering and construction activities, ranging from federal navigation project dredging to surveys of wetlands.

This section describes some of the more common USACE activities or projects requiring hydrographic survey support.

a. Project condition surveys of federal navigation projects. The Corps is responsible for operating and maintaining over 900 federally authorized coastal navigation projects plus another 12,000 miles of inland and intracoastal navigation system channels. Periodic hydrographic surveys are performed over these authorized projects to determine the current condition and clearance of the navigation channels. These condition surveys are primarily used to determine if project conditions (e.g., shoaling) have changed enough to warrant maintenance dredging, if condition surveys are required at more frequent intervals, or if a greater survey coverage density is necessary. Drawings and/or project condition reports derived from these surveys are furnished to local sponsors, pilots, commercial navigation interests, and to other federal agencies, such as the U.S. Coast Guard (USCG) and the NOAA National Ocean Service (NOS). Condition surveys of inland navigation projects are used to modify project depth conditions for the monthly updates to the Inland Electronic Navigational Charts (IENC).

b. Construction dredging measurement and payment surveys. Dredge measurement and payment surveys encompass all work associated with dredging construction activities in USACE, most particularly those surveys performed to measure the amount of excavated, deposited, and/or placed material in subsurface or upland confinement areas. These surveys also include investigative studies used for preparing contract bid documents (estimated quantities) and for directly monitoring and measuring subsequent contract performance, payment, and acceptance. These surveys require a high level of accuracy in both positioning and depth measurement so that payments will be equitable and consistent with the actual work performed. A significant portion of the Corps' in-house hydrographic survey resources are engaged in direct support of dredging operations; in particular on coastal navigation projects. A wide variety of vessels and survey equipment are used, depending on water depth, inland or coastal location, payment method (in-place or daily rate), and the type of material being dredged.

c. Underwater obstruction and investigation surveys. Hydrographic surveys are performed to locate and assist in the removal of obstructions in Federal navigation channels. Surveys of jetties, breakwaters, locks, revetments, dikes, levees, and other river control structures are performed at regular intervals to assess the subsurface condition of the structures, such as scour, shoal build up, rock voids, etc. They are used to support a variety of engineering requirements. Side-scan sonar and multibeam sonar are typically used to detect obstructions or objects on the navigation channel bottom; in particular, after major storm events or during search and rescue operations. Magnetometer surveys are performed to detect buried pipelines, locate archeological remains, and trace buried cables. Underwater investigation surveys are also performed adjacent to bridge piers, locks, and below hydroelectric power plants to assess scour or other conditions. Both acoustic and visual (camera) methods may be deployed.

d. Coastal engineering surveys. Coastal surveys are performed for a variety of engineering purposes. These surveys are used to evaluate the condition of beach renourishment and hurricane protection projects or to support coastal engineering research studies. Coastal surveys

are performed to study the effects of offshore protection structures (jetties, breakwaters, and groins), harbor entrances, estuaries, and coastlines in areas of suspected accretion, erosion, or other material movement or transport. They are also performed to develop, evaluate, and calibrate physical and numerical models used for planning and design of projects. During beach renourishment or offshore structure construction, coastal surveys are performed to measure placement and estimate payment.

e. Dam and reservoir sedimentation surveys. Periodic underwater condition surveys are performed at many of the 600 water control/supply dams managed by the Corps, including 75 hydropower projects. Reservoirs behind these dams are periodically surveyed to assess sedimentation rates and update area-capacity curves.

f. Inland navigation charting surveys. Hydrographic surveys are performed to update maps and charts of the Corps inland navigation projects--about 7,500 miles of waterways. Corps-wide, these charts involve hundreds of drawings. These surveys also include periodic updates to Inland Electronic Navigational Charts (IENC). IENC updates are performed as needed when river conditions warrant. Hydrographic, topographic, and facility features along the river are updated.

g. Miscellaneous surveys. Various other marine surveys are performed to support civil works water resources activities. These include: environmental/HTRW surveys/studies of underwater areas, periodic disposal area monitoring surveys during placement of material, offshore drill barge location, subsurface probings (wash or dry), tidal boundary surveys (e.g., MHW demarcation), river hydraulic section surveys, river current measurements, wetland surveys, and underwater archeological surveys.

1-8. Use and Scope of Manual. This manual should be used as a "best practices" technical guide in performing hydrographic surveys with USACE hired-labor forces or contracted survey forces. It is also intended to support project managers, project engineers, or construction inspectors in preparing specifications for these surveys. It should be directly referenced in specifications for contracted construction, dredging, or Architect-Engineer services. This manual focuses on quality control calibration and quality assurance testing standards for acoustic single beam and multibeam survey systems. Field operation of particular hydrographic survey positioning systems and acoustic instrumentation are only minimally covered when reference can be made to more current NOAA manuals, data collection software manuals, or manufacturer operational manuals. The recommended quality control and quality assurance criteria in this manual should be considered in developing technical specifications for surveys supporting dredging measurement, payment, and acceptance functions. This manual may be referenced should hydrographic surveying functions be required as part of a USACE military construction or environmental restoration activity. It may also be referenced for surveys performed or procured by local interest groups under various cooperative or cost-sharing agreements.

a. Scope. Chapters 2 through 7 cover basic hydrographic surveying principles, to include: an overview of general survey planning, data acquisition, and processing techniques (Chapter 2),

recommended accuracy standards (Chapter 3), single beam systems (Chapter 4), multiple transducer systems (Chapter 5), multibeam systems (Chapter 6), and GPS positioning systems (Chapter 7). The remaining chapters, along with their associated appendices, describe specific applications to Corps civil works projects. These include coastal navigation project condition surveys (Chapter 8), surveys of inland waterways, river control structures, locks, dams, and reservoirs (Chapter 9), dredging construction surveys (Chapter 10), and coastal engineering surveys (Chapter 11).

b. Recommended guidance versus mandatory standards. Previous versions of this manual contained rigid prescriptive criteria for performing all aspects of hydrographic surveys, including mandatory plant and survey instrumentation, equipment calibration procedures, accuracy standards, data collection procedures, and data plotting criteria. These "mandatory" requirements have been largely eliminated--this updated version now provides only recommended depth accuracy, quality control, and quality assurance criteria—i.e., best practices. This change recognizes the fact that each District's navigation or water control project may have unique site conditions, and that no single accuracy, quality control, or quality assurance performance standard fits all Corps civil works projects. In addition, acoustic and satellite positioning improvements are expected to occur well before future updates to this manual are scheduled, potentially rendering some of the current guidance obsolete.

c. Instrumentation theory and principles. Theory of operation for various acoustic, GPS positioning, and inertial orientation systems is only briefly outlined in this manual—references are provided to other USACE engineer manuals or technical publications for more detailed information. Equipment configuration, calibration, operation, and procedural methods for performing and processing field hydrographic surveys are now sufficiently detailed in operation manuals provided by the various equipment and software vendors.

d. PROSPECT training. This manual is the primary reference document for use in USACE Learning Center (ULC) PROSPECT Course 056 (Hydrographic Survey Techniques).

1-9. Hydrographic Surveying Requirements during Project Phases. Hydrographic surveying support is required throughout most phases of civil works navigation and water resource projects. During the early phases of a project, a comprehensive program should be developed to integrate and fund hydrographic surveying requirements throughout the various stages of a project's life. Procedures for accomplishing this are contained in ER 1110-2-1150, Engineering and Design for Civil Works Projects. Hydrographic surveying support may be required during any of the five project phases outlined in ER 1110-2-1150: Reconnaissance phase, Feasibility phase, Preconstruction Engineering and Design (PED) phase, Construction phase, and Operation and Maintenance phase. Most survey support effort is required during the later three phases.

1-10. Geospatial Data Policy. ER 1110-1-8156, Policies, Guidance, and Requirements for Geospatial Data and Systems, details Army and Corps policies for processing, displaying, transferring, sharing, publishing, and archiving hydrographic survey data. This regulation applies to hydrographic survey data generated in Computer Aided Design (CAD), Site

Information Modeling (SIM), or Geographic Information System (GIS) file formats. Supplemental implementation guidance is in EM 1110-1-2909, Geospatial Data and Systems.

1-11. Metrics. The use of both metric and English systems of measurement in this manual is predicated on the common use of both systems in engineering practice, and the exclusive use of English units by the navigation industry. Although most, if not all, electronic surveying and satellite measurement systems now acquire data in metric units, these data are readily converted to English units by the processing software. In the Corps, engineering project coordinates are normally in English units and water depths are expressed in feet and tenths. Construction units are normally measured in linear feet, square feet (sf), or cubic yards (cy). Exceptions may exist on some OCONUS or military construction projects.

a. Metric-English conversions. Due to the variety of mixed metric and English measurements, equivalent conversions are not shown in this manual; the most common measurement unit is used for example computations. Unless otherwise indicated, metric conversions are based on the U.S. Survey Foot, which equals (exactly) 1200/3937 m (or 3.280833333333 ft/m). Note that OCONUS (and some CONUS) jurisdictions, and some software platforms, use the SI conversion (30.48 m /100 International Foot exactly) instead of the U.S. Survey Foot conversion.

b. Statistics. Accuracy or uncertainty statistics, standards, and tolerances specified in this manual are defined at the 95% Root Mean Square (RMS) level (95% = 1.96-sigma for 1D depth measurements), unless otherwise indicated. The terms "Accuracy," "Error," and "Uncertainty" are often used interchangeably in this manual even though their precise statistical definitions may differ.

1-12. Trade Name Exclusions. The citation or illustration in this manual of trade names of commercially available products, including supporting surveying equipment, instrumentation, and software, does not constitute official endorsement or approval of the use of such products.

1-13. Manual Development. The original version of this manual was developed in the 1980s and first published in 1991, then revised in 1994, 2002, and 2004 (multibeam systems). Most of the standards and technical guidance in the 1991 and 1994 versions were designed to support older analog depth recording instruments, mechanical, visual, or microwave positioning, and manual data processing and drafting methods. The 2002 version added newer technologies, such as acoustic multibeam swath survey systems and differential GPS positioning techniques. Much of the visual/mechanical survey procedural methods in earlier versions was either eliminated or moved to appendices in this current version. This update covers the use of more advanced multibeam systems and enhanced vessel positioning and orientation systems using carrier phase GPS and inertial measurement systems. Field survey activities throughout the Corps participated in the development and review of this latest version of the manual.

EM 1110-2-1003

30 Nov 13

1-14. Proponency. The joint proponents for this manual in the HQUSACE Directorate of Civil Works are the Engineering and Construction Community of Practice (CECW-CE) and the Operations and Regulatory Community of Practice (CECW-CO). Technical development and compilation of the manual was coordinated by the U.S. Army Geospatial Center (CEAGC-GSA). Comments or recommended changes to this manual should be forwarded to HQUSACE (ATTN: CECW-CE). Technical issues dealing with dredging operations should be forwarded to HQUSACE (ATTN: CECW-OD).

CHAPTER 2

Overview of Hydrographic Surveys for Civil Works Navigation and Water Control Projects

This chapter provides a general overview of hydrographic surveys required for the engineering, construction, and maintenance of Corps civil works projects. It covers general survey planning, specification development, optional survey methods, vessel selection, reference datums, data processing and editing, and depth selection options. Time and cost estimating procedures are also outlined. The guidance in this chapter is primarily intended for USACE survey sections; however, portions are also applicable for use by project managers or design engineers specifying hydrographic surveys for civil works navigation or water control projects.

2-1. Required Supplemental References. The following reference manuals are required to supplement the material in this chapter.

- a. EM 1110-1-1003, NAVSTAR Global Positioning System Surveying.
- b. EM 1110-1-1005, Control and Topographic Surveying.
- c. EM 1110-1-2909, Geospatial Data and Systems.
- d. EM 1110-2-6056, Standards and Procedures for Referencing Project Elevation Grades to Nationwide Vertical Datums.

SECTION I

Overview of Hydrographic Survey Techniques

This section provides an overview of basic hydrographic survey techniques and systems used on Corps civil works projects. It covers both historical and current survey techniques. Details on these techniques are covered in the referenced chapters and appendices in this manual. The following paragraphs in this section contain general guidance on procedural and equipment options that must be considered in developing specifications for a hydrographic survey. These specifications will ultimately determine the required or resultant accuracy of a survey, as further detailed in Chapter 3.

2-2. General Hydrographic Survey Methods. Up until the 1960s, the primary method in USACE for measuring water depths utilized manual techniques. These included lead lines, sounding poles, and topographic surveys (levels and transits). Depth measurements were positioned using a variety of visual survey methods, e.g., transits, sextants, tag lines. Manual depth measurement procedures are described in Appendix B and visual positioning techniques in Appendix G. These manual and visual survey methods were gradually superseded when acoustic depth measurements (echo sounding) were implemented in the 1950s and GPS positioning in the 1990s. Echo sounders project a vertical beam from a single transducer to measure the water

depth. Single beam acoustic systems are described in Chapter 4. In the 1970s multiple transducer sweep systems were developed. These systems employ multiple single beam transducers on a boom array—see Chapter 5. Acoustic multibeam systems evolved in the early 1990s. These systems project an acoustic sweeping array beam from a single transducer. Multibeam system operation is covered in Chapter 6.

2-3. Survey Coverage Options. A primary survey specification must evaluate the density of bottom coverage required for a particular project. This specification affects the engineering use of the data and survey cost. There are two survey coverage methods that may be specified for a project: (1) Cross-Sectioning, or (2) Full Bottom Coverage. Cross-section surveys are performed by lead line, topographic survey methods, and single beam echo sounders. Full bottom coverage surveys are obtained by either multiple transducer systems or multibeam sweep systems. These different survey methods have advantages and disadvantages as outlined in the paragraphs below, and summarized in Table 2-5 at the end of this chapter.

a. Cross-Sectioning surveys. Surveys of navigation and other shore protection projects have traditionally been performed by running cross-sections at some predefined spacing, e.g., every 100 ft. Depths are measured using manual methods (lead line) or acoustic methods (single beam). Cross-section methods are most effective in shallow draft projects and in deep draft projects where the bottom topography in a channel is relatively uniform. Single beam cross-section surveys are typically the most economical method, requiring a minimal amount of survey instrumentation on the survey vessel. Smaller survey boats with low plant rental rates are used. Quality control calibration effort is usually minimal in comparison to multibeam systems. Data editing, processing, plotting, and volume computations are relatively easily and rapidly accomplished.

b. Full Coverage Surveys.

(1) Multiple transducer sweep systems. Multiple transducer boom systems provide full bottom coverage (technically ensonification). Multiple transducer sweep systems have application on shallow draft projects where full bottom coverage is required; thus, they are heavily used by USACE districts on inland navigation projects. The multiple transducer boom is designed to sweep a fixed width of the channel. Survey lines are run to ensure complete bottom coverage (or ensonification). See Chapter 5 of this manual for additional details on these multiple transducer sweep systems.

(2) Acoustic multibeam sweep systems. Multibeam systems can provide complete sweep coverage out to many times the depth of water. They have a particular application in deep draft projects where clearances are most critical, such as in new work or rock cut dredging. They are used in maintenance dredging surveys of deep draft projects and in underwater investigation surveys of underwater structures. Multibeam surveys are conducted on some shallow draft projects, particularly on some small, shallow rivers where bank-to-bank surveys are required to define the channel in rivers with moving sand beds. A full-coverage multibeam sweep will be more efficient than cross-sections in these environments. Multibeam surveys will generally cost

more than single beam methods due to the high-cost instrumentation required. Quality control calibrations and quality assurance testing are far more demanding (and time consuming) than for single beam systems. Multibeam systems require complex (and expensive) positioning and vessel orientation instrumentation. Not all projects require full bottom coverage—single beam cross sections are still adequate for many USACE projects. Therefore, project engineers must weigh the technical advantages of a full coverage survey versus sparser single beam cross-sections.

(3) In effect, multibeam systems are simply cross-sectioning systems. They can generate cross-sections of a channel many times a second, often generating a cross-section at 1-ft spacing along the channel. Hundreds or thousands of depths may be acquired each second. They can provide full-channel coverage surveys in near real-time, including on-board data processing, editing, color plots, and X-Y-Z "cloud" data files for direct import into a MicroStation or AutoCAD platform. Quantity computations using full digital terrain models acquired from multibeam data are significantly more accurate than average-end-area quantity take-offs from single beam cross-section surveys.

2-4. Survey Line Spacing and Alignment Specifications. A survey line spacing must be selected that will provide the necessary density of coverage--or overlapping coverage in the case of multi-transducer or multibeam sweep systems. On dredging projects, the survey line spacing will govern the amount of coverage over a given project area, regardless of whether lines are run as cross-sections or run parallel to the project alignment (profiles or longitudinal lines).

a. Single beam systems. For single-beam cross-section surveys run at a typical 100-ft spacing, the acoustic bottom coverage is typically less than five percent of the project by area. From this relatively low coverage density, quantity computations are estimated, the major assumption being uniformity of terrain between successive survey lines or sections. This is normally a valid assumption on many USACE navigation projects. It becomes invalid if abrupt changes occur between lines, in turn causing inaccuracies in quantity take-offs made using average end area methods. In areas undergoing construction, or where shoals or other irregularities occur, the line spacing should be made closer in order to detect and depict the full extent of irregularities. Far wider spacings are specified by project engineers for non-navigation surveys, such as river sections for hydraulic models, reservoir sedimentation studies, and coastal engineering transport studies. In general, cross-section spacing for navigation projects is 100 ft c/c and usually does not exceed 200 ft c/c.

(1) Alignments. Cross-sections are nearly always run normal to the project's centerline (baseline) alignment, a turning basin, or relative to a fixed baseline located ashore. These alignment references may also include levee baselines, beach construction baselines, or setback lines. Project alignments may be straight, circular curves, or transition curves--cross-sections are run normal to the line or curve tangent. Exceptions may occur in turning basins, wideners, or other irregular shaped areas. Figure 2-1 is an example of different cross-section alignments on a navigation project.

(2) Specifications. Most federal navigation projects have long-established (legacy) cross-section spacing and alignment specifications. Therefore, survey requests need only specify the overall survey limits and side slope coverage extensions.

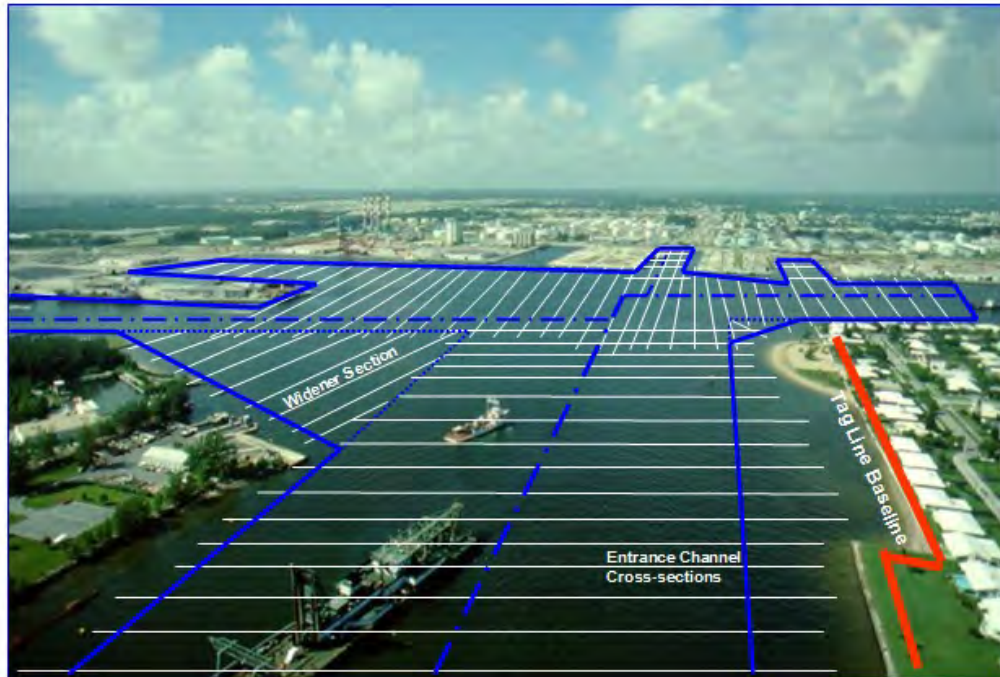

Figure 2-1. Cross-section coverage of a typical navigation project. Channel framework limits shown in blue. The red line on the right bank is a fixed baseline used on prior tag line surveys of the entrance channel. (Port Everglades Harbor, FL)

b. Multibeam systems. Acoustic multibeam systems generate a swath array from a single acoustic transducer. The coverage of this array on the bottom is dependent on water depth, manufacturer array limits, and outer beam quality degradation or loss. Some multibeam systems can be configured for over 180 deg coverage—"bank-to-bank." However, due to loss of data quality on the outer beams, the coverage array is limited based on past performance testing. Thus, the array is typically restricted to ± 45 to ± 50 deg off nadir. This restriction will determine the line spacing. Usually, an overlap is designed into the line spacing. This overlap can range from 20% to 100%, or more in critical areas. Multibeam lines are usually run parallel to the channel alignment, as shown in Figure 2-2. In heavily trafficked projects, running parallel to the channel is an advantage over cross sectioning.

(1) As stated earlier, the primary application for multibeam systems is for surveys of deep-draft navigation projects--typically those projects over 10 to 15 ft in depth. Multibeam swath widths typically range from twice to seven times the water depth. Thus, for a 40-ft project, an 80- to 300-ft swath can be obtained with a single pass, depending on the array limits set. In

Figure 2-2, the five parallel lines will provide full coverage of the channel. Additional lines may be required to detail the upper side slopes.

(2) Specifications. When multibeam surveys are requested by a project manager, they should consult with the vessel Party Chief on the capabilities of the particular system. This mainly involves the recommended array limits based on past performance tests and the amount of desired overlap. This array limit and overlap criteria will, in turn, determine the line spacing and resultant survey time and cost. Details on determining line spacing and overlaps for multibeam systems are covered in Chapter 6.



Figure 2-2. Multibeam survey line coverage on a 40x300 ft wide deep-draft navigation project.

2-5. Horizontal Positioning Methods and Datum Specifications. Prior to the implementation of GPS positioning in the early 1990s, a variety of vessel horizontal electronic and manual positioning methods were employed. These included tag line, sextant, triangulation, trilateration (electronic), and total station.

a. Each of the above methods is described in detail in Appendix G. Two of these methods are still occasionally used on isolated projects—Total Station and Tag Line. GPS positioning techniques (differential code or carrier phase RTK) are now employed on all USACE hydrographic survey systems. RTK positioning is specified on navigation projects with critical clearance requirements, marine structure construction, and underwater structure investigation surveys.

b. Specifications. Project Managers developing survey requirements can generally assume code-phase DGPS positioning will be performed and should specify carrier-phase RTK on special projects requiring sub-meter horizontal accuracy. GPS positioning methods are more fully detailed in Chapter 7 of this manual and in EM 1110-1-1003.

c. Horizontal reference datums. All USACE projects should be referenced to the National Spatial Reference System (NSRS) maintained by the National Geodetic Survey (NGS). Primary control monuments (PBMs) must be directly connected to the NSRS. GPS geocentric coordinate systems are easily (and directly in software) transformed to a local coordinate system, i.e., a local State Plane Coordinate System (SPCS). Most construction and dredging projects also establish a local station-offset grid system which is directly related to the SPCS. Project or construction specifications must clearly state the required horizontal reference datum—both the regional NSRS and the local construction station-offset system. Primary NSRS control and/or calibration monuments at the project site must be clearly identified.

2-6. Vertical Datum Specifications. EM 1110-2-6056 provides detailed guidance on establishing primary control for all types of civil works projects constructed and maintained by USACE. Coastal, inland river, the Great Lakes, and OCONUS regions are covered in EM 1110-2-6056. It provides technical instructions for connecting project control with the NOAA National Spatial Reference System (NSRS) and the NOAA National Water Level Observation Network (NWLON). EM 1110-2-6056 supplements ER 1110-2-8160, Policies for Referencing Project Elevation Grades to Nationwide Vertical Datums, that requires “controlling elevations and local datums on USACE projects shall be properly and accurately referenced to nationwide spatial reference systems used by other Federal, state, and local agencies responsible for flood forecasting, inundation modeling, water control, flood insurance rate maps, navigation charting, and topographic mapping.” In summary, survey specifications must indicate that the vertical reference datum can be related to the appropriate NSRS or NWLON system.

2-7. Water Surface Elevation Measurement Specifications. Hydrographic surveys measure depths relative to the local water surface and datum at the place of observation. The elevations on all federal navigation and water resource projects must be referenced to a specified tide or stage gage. This gage must, in turn, be referenced to an established vertical datum—hydraulic stage or tidal. Any variations between this gage datum and the project site must be modeled, interpolated, or extrapolated. Likewise, tidal phase variations must be modeled between the gage and the project site. Hydrographic surveys must be calibrated to this reference gage.

a. RTK surface elevation measurement. On projects with critical clearance grades, such as new work in rock cut channels, RTK elevation measurements should be specified in survey scopes of work. This requirement is also recommended for most construction dredging payment surveys. RTK methods are especially applicable to any navigation project where tidal phase differences between the reference tide gage and the project site are significant, as illustrated in Figure 2-3. RTK should also be used in scour surveys around locks, dams, and other structures.

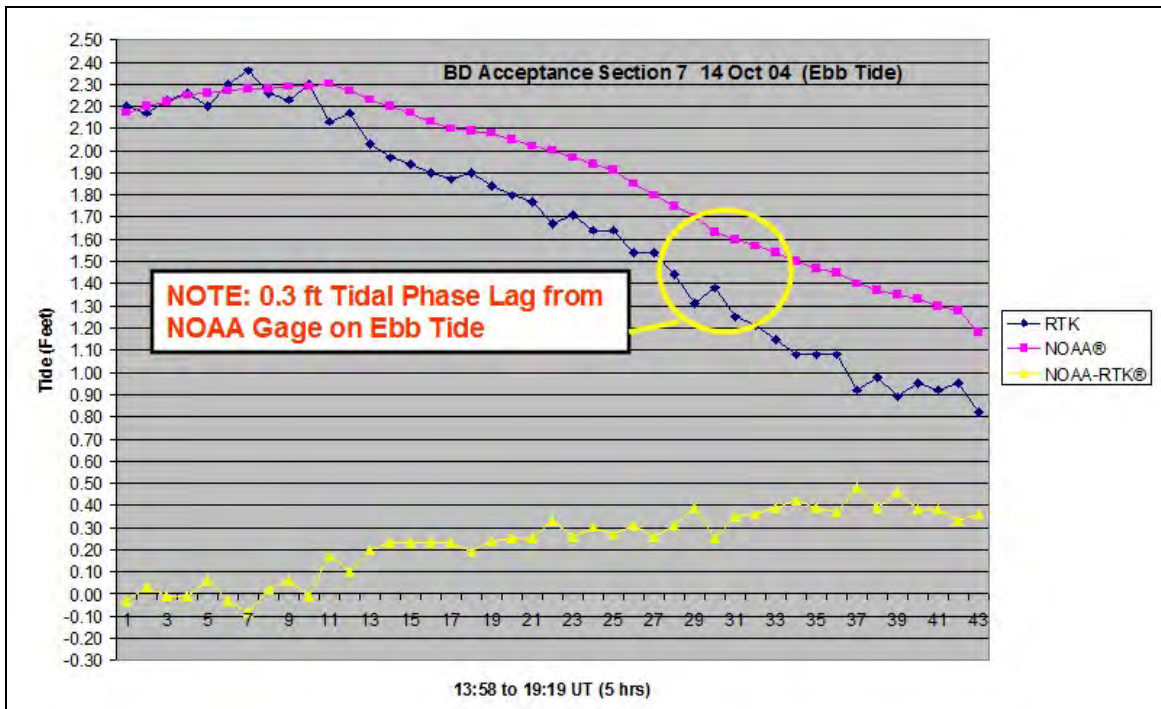

Figure 2-3. Five hours of water surface elevation differences between a NOAA tide gage at Key West, FL, and RTK surface measurements, 3 miles south in the main ship channel. This Pre-Dredge survey shows significant tidal phase differences that would be unaccounted for had only the gage been used. These constant phase differences (e.g., 0.3 ft) would adversely impact dredge clearance assessments and pay quantities if the NOAA gage were used rather than the on-site RTK surface elevations. On USACE projects with similar tidal phase and/or tidal range differences, use of RTK is essential to correct depths at the project site.

b. Specifications. Project or construction specifications should indicate the reference water level gage and datum parameters, along with any stage or tidal datum modeling requirements. RTK requirements should be specified on critical projects where direct gage data is inadequate.

2-8. Vessel Motion and Orientation Requirements. Most USACE survey vessels now are equipped with some type of motion compensation instrument. These inertial measurement instruments are generally referred to as "motion reference units," or MRUs. This instrumentation provides correction for vessel roll, pitch, yaw, and/or heave. The type, complexity, and cost of this equipment are dependent on the typical sea states encountered and specified data quality requirements for the survey. On shallow draft inland projects, motion compensation may not be required for single beam surveys. Motion compensation is essential for multibeam systems and single beam systems operating in high sea states. Motion compensation systems can exceed the cost of an acoustic depth measurement system. High-end (accurate) inertial-aided GPS motion

systems can cost up to \$200,000. Basic motion compensation systems are less than \$50,000. Details on MRUs are covered in Chapter 7 of this manual. Project engineers specifying survey requirements should be cognizant of their district's survey capabilities, and whether the lack of motion sensing equipment will adversely affect the resultant data quality.

2-9. Quality Control and Quality Assurance. QC and QA calibration and performance testing requirements are critical for all hydrographic surveys. Most of the guidance in this manual is focused on these requirements. Hired labor, A-E, or construction specifications should reference this manual for recommended QC and QA test requirements. Survey specifications should indicate whether formal Performance Tests are required in order to validate resultant accuracies.

2-10. Miscellaneous Survey Requirements. In house hydrographic survey vessels or A-E contractors may be required to perform ancillary data collection on some projects. Some of the more typical requirements are listed in Table 2-1. Project Managers developing specifications for one of these projects should contact the equipment manufacturers, data collection software vendors, or other USACE districts for current applications and guide specifications. USACE district "subject matter experts," external contacts, or reference guidance are shown in Table 2-1.

Table 2-1. Supplemental Data Collection Requirements.

<u>Data</u>	<u>Recommended Contacts</u>
Side scan sonar	Manufacturer, Norfolk District, HYPACK 2011, NOAA
Current measurements (Acoustic Doppler Current Profilers-ADCP)	Manufacturer, HYPACK 2011, St. Louis District
Bottom classification or seafloor characterization	HYPACK 2011 (Geocoder) Norfolk District
Sub-bottom profiling	Manufacturer, HYPACK 2011
Sub-bottom probings (wash/dry)	Jacksonville District
Magnetometer surveys	Manufacturer, Jacksonville District
Biological surveys	Manufacturer, St. Louis District
Dredge system configurations	Measutronics, Inc.
Unconsolidated sediments	USACE ERDC (CHL), Mobile District New Orleans District, Stema Systems
Dredged Material Density (% solids)	Walla Walla District (Cost Engineering Branch); ERDC CHL, Vicksburg, MS

SECTION II

General Planning Considerations

This section provides additional guidance on some of the more critical factors that must be considered in planning and developing specifications for hydrographic surveys.

2-11. General. Most authorized USACE civil works projects have established survey methods and procedures; therefore, minimal planning is required for subsequent or recurring surveys. This section outlines some of the planning factors that should be considered in developing survey specifications for a specific project.

a. In-house (hired labor) or contracted options. Project/Study Managers or design engineers requiring survey support may need to evaluate whether to obtain this work from in-house crews or from contracted (A-E) forces. This evaluation may include the availability and capabilities of both options. Some districts may have no in-house survey capability or their crews are engaged on other priority projects. Use of an adjacent district's survey crew is another option to consider. Task order award turn-around time is always a major factor when considering the use of A-E forces. Geospatial (hydrographic) contracting procedures are outlined in EM 1110-1-2909 (Geospatial Data and Systems) and in Appendix C attached to this survey manual. Hydrographic surveying services are procured using Brooks A-E Act (PL 92-582) qualification-based selection methods.

b. Project schedule. Demanding construction advertise dates often impact survey planning schedules, and may necessitate reduced coverage densities or other actions to expedite completion.

c. Project funding. Funding limits will often dictate the survey scope of work for a project. Limited funds often necessitate a search for the most economical survey method while still obtaining sufficient data for engineering and construction purposes. Tradeoffs typically include increasing cross-section spacing or performing less frequent condition surveys.

d. Project location. Many dredge progress payment (acceptance section) surveys can be completed in one day with current surveying technology. Thus, it is not uncommon for mobilization and demobilization time to exceed the actual survey time. This is especially true if the survey crew has a long travel distance to the work site. Small-scope survey projects always cost more per unit than large efforts, due to mobilization and general overhead costs, among other factors. To reduce costs, it is always desirable to bundle geographically close projects if possible.

e. Survey performance and productivity capabilities. The survey crew (in-house or A-E) selected for a project must be capable of performing the work in accordance with the required accuracy and performance specifications. All in-house or contract survey forces have varying hydrographic surveying capabilities. Experience and capability must be demonstrated based on

past performance. Assessing such capabilities may be difficult for a study/project manager unfamiliar with the latest survey technology. Survey productivity rates have significantly increased over the past 30 years, especially in the last 15 years with the implementation of GPS positioning methods and multibeam systems. An example of productivity increases for a typical navigation project is shown in Table 2-2.

Table 2-2. Annual Project Condition Survey--Tampa Harbor 43-Foot Project
Gulf of Mexico to Port of Tampa--Field Survey Time Required to Perform Survey

Year	Positioning	Coverage	Crew-Days	Man-Days
to 1973	Visual (tag line)	200 ft O/C	360	1800
to 1993	Microwave 100 ft	O/C	40	280
to Date	DGPS	100 % (Multibeam)	8	24

(1) Table 2-2 indicates that survey productivity has increased by a factor of about 75 times since the 1960s and about 10 times since 1993. However, the data density, accuracy, and quality have also significantly increased since 1993 (and especially since 1973) given that a full-bottom coverage (multibeam) survey was obtained on the latest survey. This table also illustrates that 2- or 3-man survey crew today equals the output productivity of three to five crews in 1993. Table 2-3 is another comparable illustration of the gain in productivity due to improved positioning methods, especially DGPS techniques.

Table 2-3. Single Beam Cross-Sections per Day on a Typical Coastal Navigation Project.
(Assumes a 400 ft channel width on a deep draft entrance project)

Year	Positioning	100-ft Cross-Sections Run	Crew Size
to 1973	Visual (tag line)	10 to 20	7 to 10
to 1993	Microwave	30 to 40	5 to 7
to Date	DGPS	75 to 200	2 to 3

(2) As a comparison between single beam and multibeam productivity, if the 200 cross-sections surveyed (i.e., 20,000 ft length of channel) with the DGPS single beam system area were surveyed with 4 to 6 multibeam lines, multibeam survey coverage could be accomplished in about 4 hours running time with the same crew size. Obviously, the major gain with the multibeam system over a single beam system is complete coverage of the channel bottom rather than isolated 100 ft c/c cross-sections. While productivity, accuracy and coverage have vastly improved, so have the costs of equipment. The purchase, installation, and initial calibration of a modern multibeam system may take several months, require a shipyard period with major modifications, and require extensive training of the crew.

2-12. Determining Project Accuracy Requirements. In general, accuracy requirements are more demanding for navigation projects where ship clearance and contract dredging payment issues are especially critical. Surveys for general hydraulic engineering studies, reconnaissance, planning, etc., usually do not require the same levels of accuracy. This distinction is not entirely rigid -- specific horizontal and vertical accuracy requirements should always be assessed and defined in the specifications for each project. Refer to Chapter 3 for more details on defining accuracy requirements.

a. Navigation and dredging support surveys. This classification applies to all surveys performed in support of the Corps navigation mission. It includes both deep-draft (> 15 ft) and shallow-draft (< 15 ft) navigation projects. Types of surveys include project condition surveys of navigation channels, dredging contract plans and specifications surveys, dredging measurement, payment, clearance, and acceptance surveys. A primary consideration involves the material characteristics of dredged material from the channel bottom.

(1) Hard bottom material and/or new work dredging. Examples include newly authorized navigation projects containing hard bottom material, such as rock or highly compacted material, or maintenance dredging of existing navigation projects containing hard bottom or otherwise hazardous material. Other examples might include navigation projects where low under-keel clearances are anticipated over potentially hazardous bottom conditions, hazardous cargo is transported, or where bottom sediment could adversely impact naval vessels transiting a project. A hard bottom classification does not require in situ bottom density sampling but should be based on a professional geotechnical opinion given local project knowledge, historical information, and project requirements. The most precise positioning and elevation measurement techniques are specified for these types of projects.

(2) Soft bottom material and/or maintenance dredging. These navigation projects include those containing soft sand/silt bottoms not judged to be hazardous to vessel hulls; or projects with soft, featureless, and relatively continuous channel bottoms where gaps in coverage between survey lines are unlikely to yield potential hazards/strikes. The vast majority of the Corps maintained waterways fall within this category. Survey accuracy and coverage specifications are usually less demanding for these projects.

(3) Unconsolidated sediments. The existence of unconsolidated sediments near the channel bottom can have a major impact on the accuracy specification for a survey, the equipment used, survey cost, and contract payment. Definitive survey specifications are required when these conditions are present. In many cases, a depth accuracy standard may not be applicable in these conditions. (See Appendix P for additional details.)

b. Underwater investigation surveys. These surveys include precise investigation surveys of/around locks, dams, power plants, abutments, piers, jetties, bulkheads, and other structures. Detailed investigation surveys of hazardous objects lying within the authorized navigation prism or project depth should follow (or exceed) the accuracy standards prescribed for navigation and

dredging surveys. General object detection may also be made using side scan or multibeam backscatter technology. Some 14 USACE districts report having this capability as of 2006.

2-13. Determining Required Data Density. The density of survey data to be collected is determined by a number of project-dependent factors. Some of the considerations used to determine the required data density, and the survey coverage needed to obtain that data density, may include:

- Type of construction project (dredging, rock placement, revetment construction, etc.) and related site investigation requirements.

- Survey data collection equipment (lead line, analog echo sounder, multiple-transducer sweep system, single head multibeam, automated data collection, etc.).

- Subsurface relief (rock, sand, silt, probability of intermediate pinnacles or shoals requiring development, etc.).

- Project economics (costs of surveys relative to engineering and design costs and estimated construction costs).

- Method of construction payment and/or computation thereof (in place, daily unit rate, average end area, triangulated irregular network, etc.).

- a. In hard material, full bottom coverage may be obtained using any of the following methods: mechanical bar sweep, multi-transducer acoustic sweep, acoustic multibeam sweep, or side-scan sonar sweep. Double (200%) bottom coverage may be specified on critical navigation projects.

- b. In soft material, single-beam acoustic systems are normally deployed, running cross-sections at some specified line spacing.

SECTION III

Vessel Selection Considerations

A wide variety and number of survey vessels are used throughout the Corps, as illustrated in Figure 2-4. These include conventional V-hull boats, catamarans, tugs, open skiffs, LARCs, pontoon boats, underwater sleds, air boats, surface-effect vessels, swamp tractors, converted barges, jack-up barges, and jet skis. Sizes of these platforms range from 14 ft up to 120 ft. This variety of floating plant is due to the different characteristics and depths of civil works projects surveyed. Many projects have unique environmental conditions and physical restrictions that require a particular type of survey vessel. This section provides a general overview of some of the factors to be considered when procuring a new survey vessel, or in evaluating the use of a type of vessel on a project.



Figure 2-4. Typical Corps survey vessels used in different project applications.

2-14. General Considerations. Since each district has unique project features and working conditions, these will primarily dictate the type of vessel used. These factors may include project depth, shallow-draft inland or deep-draft coastal navigation channels, geographical range of projects, dredging program size, and typical sea states encountered, to name a few. Selection of the most appropriate type vessel for the project conditions is critical to both production and cost. Larger vessels (greater than 26-ft) are generally more effective on open ocean entrance projects; however, their daily operating cost is high. Smaller, trailerable boats (less than 30-ft) are more efficient on inland navigation projects and coastal harbors. Smaller vessels also provide more flexibility to rapidly mobilize between projects. Their daily operating costs are significantly lower than larger platforms. However, smaller vessels are more subject to sea state motion, which can adversely affect data quality. Thus, a number of factors must be considered in selecting a survey vessel for a particular application. Some of the more important factors are discussed below.

a. Project depths. Vessel drafts must be small enough to obtain full coverage over a project, especially on shallow channel side slopes where material is excavated. If vessel drafts

are too deep, the inability to fully cover the side slope out to the required prism will impact quantity computations. In many cases, this presents a problem when large vessels with deep drafts attempt to perform cross-section surveys.

b. Splash protection. Fresh or salt water conditions will also dictate the type of vessel and survey equipment protection needed. Most hydrographic survey equipment is designed to be used in both environments. Open vessels may be used in fresh water environments where sea states are usually mild. On these open vessels only minimal equipment splash protection is needed. In salt water conditions, more care must be provided to protect the survey equipment from both splash and spray. Thus, a sealed cabin environment is usually essential.

c. Maneuverability. Water currents in rivers and tidal estuaries will affect the power requirements required on survey vessels. Maintaining headway against strong high-water river currents is essential. Likewise, vessels must have sufficient power to maneuver in coastal surf zones or near offshore structures. Generally, 23-ft to 30-ft vessels require at minimum 150-250 HP outboard engines.

d. Speed. Vessel design and power must provide for high running speeds to reach remote projects from their base or launch site. Typically, 20 kt to 35 kt transit speeds are required. Vessel survey speed is not an issue as these are normally well less than 10 to 15 kts.

e. Optimum hull designs for wave and sea state conditions. In the past, large survey vessels were required to reduce the affect of the heave, pitch, and roll created by heavy sea states. Now with state-of-the-art inertial motion reference units being able to correct for these sea state effects, smaller survey vessels can be used. The vessel hull design should provide as much stability as possible, especially minimizing roll. Pitch is difficult to control regardless of hull design. Various catamaran hulls appear to provide the best roll stability. In addition, they provide better multibeam transducer mounting options (see Chapter 6).

f. Daily operating costs. The daily operating cost is a function of vessel length, crew licensing requirements, and size of survey crew attached to the vessel. Larger (> 26 ft) survey vessels have significantly higher plant rental rates than small, trailerable vessels. This is due to the increased operation and maintenance costs, and requirements for USCG licensed operators on these vessels. Vessel utilization is another factor: there must be a sufficient deep-draft navigation project workload to ensure a 30-ft to 65-ft vessel can be effectively utilized (funded). Many survey vessels are PRIP funded and may be used for other non-survey applications, which increases their utilization. Whether the vessel is project or PRIP funded may also be a factor governing utilization and operating costs.

g. Data collection, editing, and processing enclosure. A comfortable, enclosed cabin is desired on most survey vessels, both for data collection and processing. A vessel with a sufficiently large cabin can be used to perform field-finish data editing and processing. This is often a desirable feature on dredge payment and clearance projects when same-day survey data

results are needed. Humidity control (air conditioning) should be included, especially in southern climates.

2-15. Vessel and Equipment Acquisition. Districts upgrading or replacing survey vessels should contact other districts that have recently made similar upgrades. Adjacent districts with comparable project conditions would be the best contacts. These other districts can provide vessel design drawings and, most importantly, any lessons learned after deployment of their new vessel or system.

a. Marine Design Center. The Corps of Engineers Marine Design Center in Philadelphia may be contacted for support in the design and procurement of larger (> 26 ft) survey vessels.

b. Community of Practice (COP). This web-based point can be used to query all USACE districts for recommendations on vessel and equipment upgrades.

SECTION IV

Data Processing, Editing, Depth Selection, and Plotting Options

All USACE hydrographic survey data are either collected by automated acoustic systems or converted from topographic survey observations into an automated format. Final data processing and plotting are accomplished using onboard or office-based computer systems. There is no prescribed USACE standard for hydrographic data collection, editing, graphic transfer, or plotting format. Each district has established methods and formats that support their varied projects and users of these projects. This section discusses some of the general data collecting and processing methods used throughout USACE.

2-16. Hydrographic Data Processing Flow. Figure 2-5 illustrates the general flow of data processing procedures generally representative of current hydrographic software acquisition and CADD processing systems used throughout the Corps. Field corrected data are transferred to the single beam or multibeam editors for subsequent correction and editing, usually performed in the district office. Cross-section files or matrix files are generated for use in hard-copy plots or volume computations. Final processed data are also exported to MicroStation, AutoCAD, or ESRI platforms for various engineering applications.

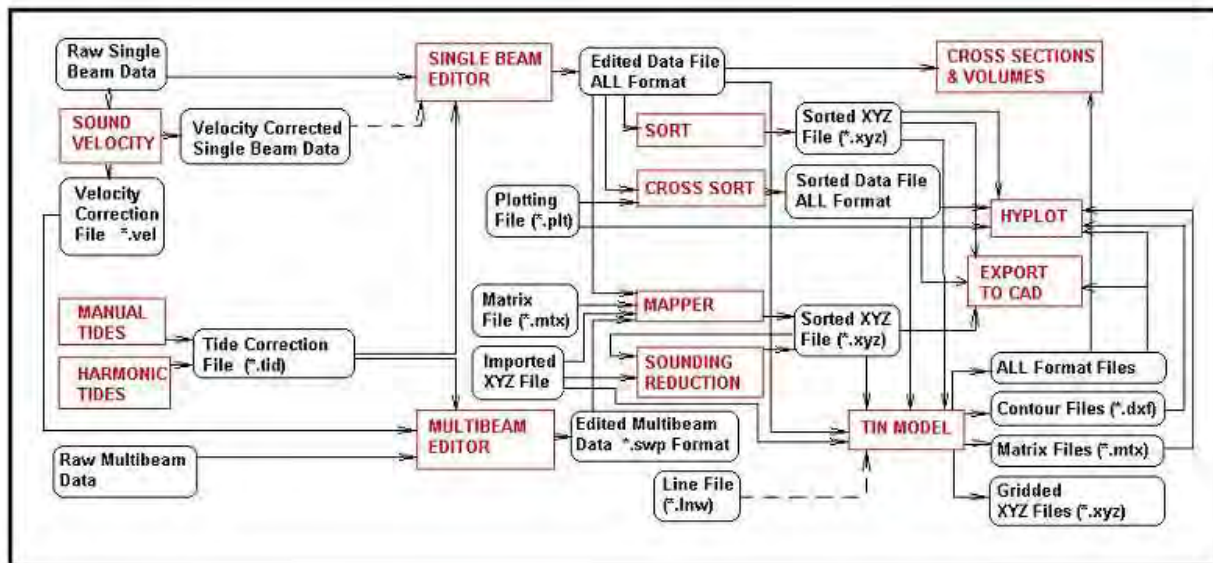

Figure 2-5. HYPACK post processing flow diagram for single beam and multibeam data. Other vendors (e.g., Trimble, CARIS) have software systems with similar functions.

2-17. Initial Field Data Review and Editing. After field data acquisition is complete, the data may be initially reviewed and edited in the field. In some districts, some initial processing may also be performed in the field. Editing is typically performed by manual processes described hereafter; however, software data editing algorithms have been developed to adjust, filter, smooth, edit, and thin hydrographic survey data.

a. QC and QA field processing. QC calibrations and QA Performance Tests are conducted, processed, and evaluated aboard the survey vessel. This includes real-time monitoring of motion sensors and sound velocity data.

b. Data anomalies. While editing the depth data, the field surveyor should also be alert for any unusual or questionable features indicated within the echo sounder data. For instance, a slight rise or depression on a normally flat bottom may be the indication of a side echo or scour hole associated with a nearby obstruction. Any echo sounder or multibeam features that cannot be adequately resolved or defined should be noted; additional data may have to be acquired in the areas immediately around these unresolved features.

c. Depth interpretation in unconsolidated or suspended materials. Other types of bottom conditions can also affect the extent to which the depth data must be reviewed and edited. In naturally soft bottom areas, or in dredged areas with unconsolidated materials, it may be difficult to detect or even define the "true bottom." A low-frequency transducer signal (e.g., 10 – 50 kHz) can usually penetrate a soft bottom layer and can help identify the first hard bottom return. However, even if a dual frequency echo sounder is used, it can still be a somewhat subjective decision as to what constitutes the true bottom. This can become a major point of contention

during dredge payment surveys and must be resolved in a consistent and equitable manner. Frequently, the surveyor must prove to the project manager and the dredge contractor that the depths they are using provide the “best” and most consistent representation of the bottom. In shallow water projects, random pole soundings or lead-line soundings can be obtained to verify the accuracy of the echo sounder depths. This is more difficult in deeper projects, though lead-line soundings may still be possible in ideal conditions. The surveyor can also highlight the comparisons of overlapping survey data outside of the dredged or disturbed areas to prove the consistency of the overall survey operations. Additional details regarding assessment of depth measurements in suspended materials or fluid mud are covered in Appendix P.

d. Final field review. After all necessary position, velocity, orientation, and depth edits have been completed, the surveyor should review the overall edited survey package to ensure that adequate and complete bottom coverage has been obtained. Ideally, this initial editing and review of the data should take place in the field so that any additional field work that may be required can be quickly addressed. This is particularly true for projects that are distant from the area where the survey party is based. During this data review, the surveyor should also check the consistency of the present survey data by comparing any overlapping sounding data. If the survey area is part of a dredging project, or has been surveyed in the recent past, then the current survey data can also be compared against any prior survey data to provide another measure of the reliability of this data. Any additional field data that are required to fill in coverage holes caused by rejected data, to better define a potential bottom feature, or to resolve some other discrepancy, should be acquired as soon as possible. This additional data should be edited and then combined with the prior survey data.

2-18. Office Data Editing and Processing.

a. District office review of incoming field data package. If the field performed some of the preliminary editing and/or pre-processing of data on board the survey boat, then the amount of district office review will be minimal, and will primarily be a quality assurance check on the adequacy of the field data editing. A cursory scan of cross-sections is usually adequate to pick up any editing deficiencies. Comparisons with any recent surveys may be performed as part of this QA process. For contract dredging surveys, pre- and post-dredge sections may be compared.

b. Editing depth data. Generally, bad depth data can either be rejected or edited, but should not be smoothed. During depth editing, the digital depth record should be compared to the analog echo sounder trace (if available). In addition to checking for incorrect or outlier digital depths (i.e., “spikes”), the editor should also ensure that the critical strikes or shoals have been digitized. For instance, if the peak of a shoal or obstruction was not digitized, then the editor must scale this depth from the analog record and then insert it into the proper location within the digital record. For single-beam cross-section surveys, there is usually not a lot of depth data editing or inserting that must be done. However, for multibeam surveys, and surveys conducted over irregular or varying bottoms, it may take a careful review of the records to ensure that the digital data accurately depicts the true bottom.

c. Data thinning routines. High-density data sets cannot be plotted in plan view due to overlapping depths. A number of methods are used in commercial data processing software to reduce the size of large data sets. These thinning routines typically use the TIN surface model to evaluate the terrain gradient in deciding which depths to eliminate. In flat areas, more depths can be eliminated without loss in overall model accuracy. In many cases, data reductions of 80% to 90% can be made in smooth terrain. Some software thinning routines use TIN contour density to eliminate data points in the TIN. Over thinning of data sets for dredge volume computations is not recommended. These data sets may be thinned for plotting/display purposes. Another method of data thinning uses a grid with an established origin point, azimuth, and grid spacing (HYPACK Matrix). Each gridded section is called a bin or cell. The bin size is determined when the matrix is built, e.g., a 5 ft x 5 ft matrix. This method is further described below.

2-19. Depth Selection Options. Once raw data points are collected within their given positional cell, the multiple depths within each cell may be thinned to a single representative depth for that cell. Binning or gridding routines provide options to thin multiple depths within a cell. Although designed for reducing the size of multibeam data, these binning routines may also be used for single beam data as well. Various representative depth outputs are possible with binned data:

- Minimum depth within the cell (e.g., "shoal biasing")
- Maximum depth within the cell
- Average (or mean) of all depths recorded within the cell
- Median of all depths recorded within the cell
- Shot depth closest to the cell center

Each of the above depth selection options has advantages and disadvantages. On dredge measurement and payment surveys where multiple passes are made, a small (e.g., 5 ft x 5 ft) cell could contain, say, 5 to 50 data points, from which a single representative (i.e. "thinned") depth must be selected. One of these points could be a noise "spike" that was missed during the editing process. The average of 50 depths within the cell may not be representative if the cell is too large and shoaler depths within the cell are obscured by the average. Likewise, the shot depth nearest the cell center (centroid) may not be representative. Therefore, selecting a bin size and representative thinned depth for a given project is a complex task and should be based on experience with specific project applications. Recommended bin sizes and depth selection options for multibeam surveys are outlined in Chapter 6.

a. Shot depth. For most applications, the "shot depth" closest to the cell center is used to best represent the terrain. This is because some of the other options can significantly bias the terrain representation if the cell sizes are too large, resulting in a false depiction of the true bottom condition (and dredged quantities). Statistically, a shot depth selection represents the best option for depicting datasets in that no inherent biases are produced in thinning the data. (Use of an unthinned raw dataset is, in effect, nearly unbiased; however, the size of the raw dataset may be too large for efficient quantity computations.) The position of the shot depth is typically shifted to the X-Y coordinates of the center of the cell.

b. Average (mean) depth. The "average depth" option can overly smooth the data if cell sizes are too large; however, this may be desirable in some instances. If cell sizes are kept relatively small, then the average depth can be a good representation of the bottom condition; and will represent a consistent, equitable payment method in dredging surveys. "Average" depths within a small, fixed bin size are recommended for computing dredged quantities. If bin sizes are set too large, then averaged depths may not be desirable on excavated slopes. (Visual interpolation of analog depth records on single beam surveys, in effect, averages the depths nearest the fix event mark. If single beam averaged depths are recorded, the system software may tag a position with the center of the depth series--requiring some form of on-line position interpolation.)

c. Median depth. The median depth of all depths in a cell will generally be nearly equal to the average depth when a large number of depths fall within the cell. The median depth may be superior to the average depth if noise spikes have not been adequately filtered out. For example, in a cell containing three depths (6 ft, 7, ft, and 17 ft), the median depth would be 7 ft but the average depth (10 ft) is biased due to the 17 ft spike. Selection of a median depth also provides use of an actually observed depth, as opposed to a resolved average depth. Although this distinction is not significant in a 1x1 ft or 3x3 ft cell, it may be justified for legal purposes. With large data sets in a cell, one of the observed depths nearest the average could equally be selected.

d. Shoal-biased or minimum depth. The minimum depth recorded within a given area has often been used for strike detection, dredge clearance, and controlling channel depth purposes. NOAA uses these minimum recorded or "shoal-biased" depths on nautical charts as a form of safety factor. Shoal-biased depths for Corps construction applications should be used with caution unless multiple "confirmed hits" are recorded within a bin, and/or between adjacent bins over a given area. Use of minimum shoal-biased depths can adversely skew dredge quantity computations and erroneously portray clearance depth data. Raw shoal biasing can also skew minimum clearance computations on Channel Condition Surveys or on tabular Channel Condition Reports. Shoals above project grade must be assessed based on multiple hits over successive passes--the least depth recorded in a bin is not necessarily the absolute elevation over an object. This is due to the relatively high variance in acoustic depth data--see discussions in this manual on data accuracy and confidence levels of assessing multiple hits. Automated software has been developed to perform this "multiple hit" analysis within each bin, and output bins containing depths with "confirmed" hits above a specified grade.

e. Maximum depth. Although this is a depth selection option, there are few USACE applications for processing maximum depths in a project.

f. Depths selection method for dredging volume computations. The "average depth" of all depths, or alternately the "median depth," within each cell is recommended as the representative depth for the cell. The horizontal location of the representative average or median depth is the cell center or centroid. The representative average or median depths are then used to generate rectangular digital terrain models (DTM) or triangulated irregular network (TIN) models from

which dredge volume computations are computed in CADD routines using all the bins in the edited dataset matrix. If optional average end area volume (AEA) computations are performed in soft material by generating simulated cross sections through the full DTM or TIN model, cross sectional spacing shall be kept small so that AEA approximation errors are minimized. For example, a 5-ft cross-section spacing is far more accurate than a 100-ft spacing, and will better approximate the volume derived from a full TIN model computed using CADD differencing routines.

2-20. Hard Copy Plot Options.

a. Plan. A vast majority of surveys are plotted in site plan mapping format. Dredge plans & specifications surveys and subsequent payment surveys are usually plotted at scales of 100 or 200 ft to the inch, depending on the detail required. For more detailed construction work, larger scales (e.g., 1 in. = 40 ft and 1 in. = 50 ft) are commonly used. The recommended plan scale is 100 ft to the inch; however, 200 ft/inch or 400 ft/inch may be used where routine maintenance work is involved. A disadvantage of plan format is the inability to portray all the collected data at a reasonable character size. To increase data density requires a scale reduction, which increases the number of sheets covering a project and subsequent reproduction costs. Plan data are usually contoured relative to an absolute reference datum or an intermediate face above grade. Planimetric data may be added to the drawings depending on the nature and purpose of the survey. Some of the more advanced presentations can show contoured or color-coded depths of material above the channel template giving a clearer picture of where the dredging is needed and how much material is there.

b. Section. Section or profile views are often used to depict dredging cross-sections. They are extremely useful in comparing and evaluating various surveys performed over the same cross-section, a common requirement in dredging work. Such comparisons are difficult to perform using plan views. Section views of channels and other construction work are typically drawn at scales of sufficient size to adequately detail construction placement/excavation. Horizontal scales of 20 ft/inch, 40 ft/inch, and 50 ft/inch are common for navigation projects. Vertical scales are usually exaggerated to either 5 ft/inch or 10 ft/inch in order to depict low-gradient side slopes (and to provide a larger end area face when planimeters were used to measure end areas). Usually, all recorded elevation data points can be plotted in section; however, the numerical value must be scaled from the drawing. Two-dimensional section plots cannot portray any along-section vessel misalignment. Section views are rarely used for project condition surveys.

c. Profile. Profile sections from surveys run parallel (i.e., longitudinally) along the project alignment are typically used for project condition reports or centerline reconnaissance surveys/studies. Profiles of channel centerlines or quarter-points can depict an extensive amount of information in relatively compressed scales, and will readily portray critical, above project grade spikes or shoals. The use of profile format can significantly reduce the number of sheets required to cover a given project. For example, a project condition survey requiring a total of 10

to 15 plan sheets at 1 inch = 200 ft can be effectively shown in one or two profile drawings at 1 inch = 5,000 ft.

2-21. Selecting Representative Depths on Plan Drawings. When individual depths are plotted on a traditional plan drawing at some fixed scale (e.g., 1 in = 200 ft), the method by which a particular depth is selected from a dense multibeam data set is a difficult process. This was not a problem with older lead line or single beam survey methods--data were recorded at 20, 25, or 50 ft intervals and all the observed depths could be easily plotted on a 1 in = 100 ft or 1 in = 200 ft drawing scale. With multibeam data points being collected at 1-ft-sq footprints or smaller densities, it is impossible to portray the data at any reasonable or realistic two-dimensional hard copy drawing scale. The entire raw or binned dataset of individual depths, or equivalent three-dimensional terrain models, can be viewed on computer displays. However, as long as traditional hard copy drawings of plotted depths are required, then standardized procedures must be developed for plotting representative depths from the large multibeam database.

a. Drawing note on plotted depth selection. Plan drawings used in contract plans and specifications, dredging as-built surveys, disseminated project condition surveys, etc., should clearly indicate the thinning and depth selection option used.

b. Plotting selected depths on dredging and navigation surveys. For generalized plan drawing portrayals of a project condition, plans & specifications, or dredging progress survey, a "shot" depth taken from randomly selected bins provides the most unbiased representation of the pre- or post-dredged bottom condition. Shot depths are randomly selected from the edited bins. As outlined above, only a small percentage of the depths in the dataset matrix can be shown on typical plan drawing scales used in USACE (e.g., 1 in = 100 ft). Plan drawing CADD note block layers/levels should clearly state that the generalized plotted depths are not representative of the full dataset, and that the plotted depths shown should not be used for channel clearance or volume computations; and also noting that the original binned dataset should be (or was) used for such purposes.

c. Depth resolution and rounding. Depths should be rounded using standard engineering practice. Some districts round depths to the nearest even foot. In many USACE districts, it is a standard practice to record and plot corrected depths to a resolution of 0.1 ft. This implies an accuracy (i.e., ± 0.05 ft) that does not reflect the uncertainties in acoustic depth measurements, especially on deep-draft navigation projects. Therefore, the estimated depth measurement uncertainties should be included in the metadata file for the survey project, and stated in the note block on any drawings or files furnished to the public or dredge contractors. Refer to the guidance on reporting depth uncertainties in Chapter 3.

d. Contour or color-coded plots. As an alternative to traditional 2D plan view plots of individual depths, contour or color-coded point 2D plots or 3D models may be used to better depict project conditions. This allows use of the entire edited (or binned) dataset.

e. Plotted depth options for single beam surveys. Single beam profile data may be thinned using intelligent data thinning software routines. Placing data points at evenly spaced distances (single-beam binning) along the cross-section track may corrupt the topography. Intelligent software is available to filter and thin data while maintaining integrity of the profile. When depth databases are thinned for plotting or other purposes, the random shot depth should be used. If databases are sorted to reduce the density of depths collected along a cross-section, then random depths along the section should be selected such that overplotting adjacent depths is avoided. Use of randomly thinned depths most correctly represents the original database and the accuracy of the individual observations.

2-22. Terrain Modeling. Most hydrographic data acquisition and processing software, and office CADD or GIS packages, now provide terrain modeling modules to allow input, modeling, editing, and analysis of 3D models. A user has direct interface necessary to build a non-uniform space point files (XYZ file) that can be used to create triangulated models and/or gridded models. Triangulated models can be created by two methods, Triangulated Irregular Network (TIN) and Topological Triangle Network (TTN). A TIN file is a surface model created from an XYZ file. It is defined by a set of 3D triangular facets, which are defined by lines drawn between the points that define the surface. The TTN file is a surface model created from an XYZ file and surface specific features, such as breaklines, obscure areas, faults and edges. These elements form an intelligent network that contains information about neighboring triangles. A grid file contains uniformly spaced data that can be derived from a number of sources including XYZ files, TIN and TTN files, digitized or scanned contours, or translated outside sources. After creating the appropriate files, the user can create and display the 3D model. To interpret the terrain models, the operator has a variety of procedures available, including:

- 2D and 3D contour displays
- 3D cross-sections
- 3D profile models
- 2D and 3D triangulated models
- Color-coded elevation displays
- Color-scaled contours
- Shaded relief (both color and monographic)
- Stereo displays (3D raised models)

The user also has the necessary procedures to edit the terrain model by adding, deleting, and moving points and inserting new profiles, area edits, noise removal, and arithmetic operations. Options are also available to perform analysis options, such as line-of-sight displays, intervisibility studies, volume calculations, and creation of slope or aspect models.

2-23. Data Submittal to District Office Project/Design Engineer. After review of the edited and processed data, the final data files and/or drawings are submitted to the district element that requested the survey. Generally, these submittals may include both raw and edited digital survey data, CADD files, echo sounder records, survey notes or field books, supplementary tide or GPS data, digital or regular photographs taken, metadata files, and any other relevant survey

information. Note also USACE spatial data policy requirements regarding Enterprise Geographic Engineering Systems (EGES), as outlined in ER 1110-1-8156, Policies, Guidance, and Requirements for Geospatial Data and Systems, and EM 1110-1-2909, Geospatial Data and Systems.

2-24. Retention of Hard-Copy Depth Records. Real time, hard copy depth profile records of navigation and dredging surveys are often used in the field to visually evaluate project condition and clearance. This may be done using hard-copy (paper) depth recordings or digital play-back recordings. Retention of real-time (or near real-time) profile depth records is required for contract measurement and payment surveys since these analog records contain bar check calibration data and Performance Tests as a continuous part of the record. These data can be retained either in hard-copy form or on a digital record that cannot be edited.

SECTION V

Estimating Costs for Hydrographic Surveys of Navigation Projects

2-25. Factors to Consider in Estimating Survey Time. The general guidance in this section is applicable to both A-E and in-house surveys. A-E survey cost estimates are covered in more detail in Appendix C.

a. Mobilization and Demobilization. This includes travel time to and from the vessel berthing location to the general project site. For USACE districts, the base location is the district office or an area office. A-E base locations are their home office. Cost estimates must allocate reasonable travel times to reach the project site. This includes both the survey vessel and survey crew.

b. Set up time at project site. Initial site preparation time can be highly variable, depending on whether survey control or gages need to be set. This may also include locating ramps or berthing. On projects with established control and gages, set up time will be minimal; basically checking existing control. If existing project control is inadequate, time must be allowed for establishing vertical control, setting staff gages, leveling and traversing baselines, and various other project-specific work. Since most authorized Corps projects have existing horizontal and vertical benchmarks and gages, preparatory set up time will be less than a half-day effort.

c. Travel time from berth to/from survey site. Cost estimates must include vessel travel time from a temporary berth or launch ramp to the survey site. This is also a highly variable time estimate, depending on the distance, vessel speed, and sea conditions. One to two hour travel times are not uncommon. Thus, a considerable portion of a productive survey day can be consumed just getting to and from the work area.

d. Quality control and assurance calibrations. Once underway to or at the work area, various quality control calibrations may be required, including horizontal position checks, RTK

gage calibrations, bar checks, velocity probes, Patch Tests, Performance Tests, etc. The time to perform these QC and QA is project dependant. On critical navigation projects, performing these calibrations may consume one to two hours each day. On less critical projects, these checks may entail only a half-hour per day effort.

e. Survey time. The amount of actual survey running time each day is dependent on the optimum vessel survey speed that provides acceptable data quality. In general, most surveys of Corps navigation projects are run at less than 15 kts, slower on more critical projects, and faster on high shoaling projects. Given a required survey scope of work (number and length of cross-sections or parallel multibeam lines), the total survey length (in miles) can be simply calculated; and given the optimum survey speed, the total survey time determined. Obviously, the number of hours per day of actual survey time is limited by the above travel times and calibration requirements. Thus, in a typical 8-hour work day, only 5 to 6 hours of effective survey time will be performed. On most projects, it is far more effective to authorize 10 to 14 hour workdays, to minimize these non-productive transits and calibrations, and maximize actual survey time. Those performing cost estimates may not have control over work and overtime authorizations; therefore, an 8-hour workday may have to be assumed. The number of hours of daylight may also need to be considered in northern regions.

f. Allowances and contingencies. Few surveys in marine environments are not impacted by equipment breakdowns, calibration problems, adverse weather, adverse sea states, and numerous other unforeseen problems. Estimating such contingencies is difficult and requires guidance from personnel with direct experience at the project site. Contingency estimates typically range between 5% and 20% of the overall estimated time.

g. Field data processing, editing, QA assessment. Usually, field survey crews perform preliminary QA assessments and data editing before sending survey data to the main office for final processing.

h. Office data processing, editing, QA assessment, plotting, and final deliverables. Time and cost estimates must include provisions for processing the raw survey data to the required final deliverable format. Depending on the data collection method, this is a highly variable estimate. Costs are based on burdened labor rates for a CADD or civil technician.

i. Office supervision and inspection. On A-E contracts for surveying services, an allowance is made for a PE or PLS to review the data prior to submittal to the District Office. The daily rate for this review is in the A-E contract schedule. USACE in-house supervision may be included in the technical overhead.

j. Potential resurveys-dredging projects. Allowances must be made for potential repeated clearance surveys on dredging projects, especially on new work or when rock cut channels are involved.

2-26. Plant Rental Rates. USACE daily plant rental rates are periodically computed based on vessel utilization. They usually include all vessel operating and maintenance charges, PRIP charges, and vessel operator charges. These daily rental fees vary significantly with the size of the vessel. They can range from less than \$1,000/day for small vessels to upwards of \$5,000 for 65-ft vessels. Rental rates can be obtained from Operations Division records. A-E plant costs are listed in the negotiated contract schedule. Various equipment, fuel, or other items may need to be combined to arrive at a daily rate.

2-27. Crew Labor Rates. Currently, survey crews consist of either two or three persons. Generally, only two survey persons are used on larger vessels--vessel operators are included in the plant rental rates. On smaller vessels (less than 26 ft) typically three persons are required, one of which is a boat operator. When staff gages must be manually observed, or local RTK base stations manned, either the third crew person or an additional person is required to perform this work.

a. A-E forces. Crew labor rates on A-E contracts are established in the negotiated contract schedule, typically a two or three person crew for smaller vessels. The A-E contract schedule will usually have a breakdown for a Party Chief, Survey Assistant, Survey Aid, and other personnel.

b. Hired labor forces. Crew rates for hired labor crews are available in USACE databases (e.g., CEFMS). These rates should include all direct and indirect overheads.

2-28. Effective Daily Field Survey Crew Rates. Most districts establish hired labor or A-E schedule crew rates on a lump sum basis, i.e., consolidating plant rental, equipment, surveyor labor, overheads, per diem, vehicles, etc. into a total daily survey rate. This simplifies computing time and cost estimates in that the time estimate need only be multiplied by the effective daily rate to arrive at a total survey cost. Alternatively, individually scheduled items can be accumulated to arrive at a total rate for a particular project. For example, the individual rates for the vessel, sonar system, positioning system, personnel, per diem, total stations, survey hubs, supplies, fuel, vehicles, etc. would be accumulated. Unless a unique project is involved, it is recommended that a lump sum daily crew rate be used.

2-29. Survey Time and Cost Estimates. The following cost estimate (Figure 2-6) illustrates the general factors that must be computed in developing time and cost estimates for hydrographic surveys. They are applicable to A-E or hired labor estimates. Assumed daily crew rates for single beam (\$1,000) and multibeam (\$3,000) systems are for illustrative purposes only, and are based on three-person crews.

REQUIRED:
Plans & Specifications Survey of a 40-ft x 400-ft deep draft navigation channel
10 mile (52, 800 ft) straight trapezoidal channel section with 3 on 1 side slopes

SINGLE BEAM COVERAGE ESTIMATE

- 100 ft. C/C
- Extend 3 on 1 side slopes 200 ft outside toes
- Perform 4 QA cross-line check lines.

Number of cross-sections: $52,800 \text{ ft} / 100 \text{ ft} + 1 = 529$ cross sections
Coverage along each section: $400 \text{ ft channel} + 2 \cdot 200 \text{ ft slope} = 800 \text{ ft}$. Use 1,000 ft incl/turns.

Estimated survey coverage (nautical miles—nm):
 $529 \text{ x-tions} \times 1,000 \text{ ft ea} / 6076 \text{ ft/nm} = 87 \text{ nm}$
 $4 \text{ cross-lines} \times 52,800 \text{ ft} / 6076 \text{ ft/nm} = \underline{35 \text{ nm}}$
Total coverage distance: 122 nm

Assumed survey speed: 5 kts then 122 nm @ 5 kts ... 25 hours running survey time
Assumed effective daily production rate: 5.5 hrs/day (includes transit, QC, QA, etc)

Estimated survey time: 25 hours survey time / 5.5 hours/day = 4.5 days ... **use 5 days**

Estimated Survey Cost: 5 days at \$1,500/day = **\$ 7,500**

MULTIBEAM COVERAGE TIME ESTIMATE

- 90 deg limiting beam array (a)
- 10% sidelap coverage (s)
- one line on side slope outside each toe

From Chapter 6:
Line Spacing: $L = 2d \tan (a/2) \cdot (1-s) = 2 \cdot 40 \cdot \tan (45 \text{ deg}) \cdot (1 - 0.1) = 72 \text{ ft}$
Number of lines: $N = \lceil 400 / 72 \rceil + 1 = 6$ [plus 2 for side slopes] Total: 8 lines

8 lines @ 52,800 = 422,400 ft or $69 \text{ nm} \times 1,000 \text{ ft ea} / 6076 \text{ ft/nm} = 87 \text{ nm}$

Assumed survey speed: 5 kts then 87 nm @ 5 kts ... 14 hours running survey time
Assumed effective daily production rate: 5 hrs/day (includes transit, QC, QA, etc)

Estimated survey time: 14 hours survey time / 5 hours/day = 2.8 days ... **use 3 days**

Estimated Survey Cost: 3 days at \$4,000/day = **\$ 12,000**

Figure 2-6. Survey time and cost estimate example.

a. Single beam versus multibeam survey time and cost estimates. The above example illustrates productivity differences between single beam and multibeam systems; i.e., 5 days for single beam versus 3 days for a multibeam system to cover the same project area. Any time advantage in the multibeam system will be offset by its added cost (rental rate) per day. However, this cost differential is offset by the added benefit of 100% bottom coverage with the multibeam system versus less than 5% for the single beam system.

b. Effective daily production rates. The assumed effective daily production rates (i.e., 5 or 5.5 hours per day) are a critical factor in the time estimate, and subsequently cost. In the above example, these rates are based on an assumed standard 8-hour working day and 2 or more hours of transit, set up, and QC actions. This standard 8-hour day is often assumed in developing A-E Independent Government Estimates (IGE) or in-house hired labor cost estimates. Ten hour, twelve hour, or longer workdays are more effective in minimizing transit times, and QC/QA calibrations; notwithstanding taking advantage of ideal weather or sea state conditions.

(1) Single beam. If a 10-hour workday is assumed, the total estimated survey time is reduced from 5 days (8-hour workday) to 3 days. If a 12-hour workday is assumed, then the survey could be completed in 2 days.

(2) Multibeam. The 10-mile project could be surveyed in 2 days with extended work hours per day; conceivably even in a 16-hour day.

(3) Vessel speed. The 5 kt assumed speed for the single beam survey is likely too conservative. Upwards of 10 kt survey speeds could be assumed; thus reducing the survey time considerably. The 5 kt multibeam speed is likely representative for a P&S quality requirement.

c. Mobilization and demobilization. Crew mob/demob from the home office to the field project site must be added to the overall cost estimate. These rates are typically the same as the daily crew survey rates (i.e., \$1,000 and \$3,000 in the above example).

d. Set up time. Additional crew time must be added for miscellaneous preliminary actions that must be performed prior to surveying. If this example were on an established project, with existing gages and control, set up time would likely be negligible. If not, then an additional crew day should be added.

e. Contingencies. An allowance for weather and mechanical breakdowns must be added to the overall field time/cost estimate. For a 3 to 5 day survey in the example, perhaps one day for contingencies might be added. These rates are the same as the daily crew survey rates (i.e., \$1,500 and \$4,000 in the above example).

f. Office data processing and QA review. In the above example, single beam processing to final deliverable would be less than one days labor; perhaps two days at the most. Since multibeam editing requires more effort (and is dependent on the data quality), two to five days

CADD labor might be allocated to this sample project. Any A-E or District Office QA oversight labor may also be added to the estimate—typically 4 to 8 hours.

g. Total cost estimate—single beam survey. Table 2-4 is a simulated example showing the estimated accumulations of all the survey cost factors, using the previous single beam example. (Rates shown are for illustrative purposes.)

Table 2-4. Total Survey Cost Example (Single Beam Survey)

Field Survey Cost:	5 crew days @ \$1,500/day	\$4,500
Mob/Demob:	2 crew days @ \$1,500/day	\$3,000
Set Up:	0.5 crew days @ \$1,500/day	\$ 750
Contingencies:	1 crew days @ \$1,500/day	\$1,500
Office processing:	2 CADD tech days @ 350/day	\$ 700
Office PM Review:	1 Day @ \$750/day	\$ 750
	Total Estimated Cost:	\$11,200

SECTION VI

Decision Matrix: Single Beam v Multibeam Surveys

The following table compares some of the applications and costs of single beam and multibeam systems.

Table 2-5. Decision Matrix: Single Beam v Multibeam Systems.

<u>Evaluation Factor</u>	<u>Multibeam</u>	<u>Single Beam</u>
Project depth, applicable	typically > 12 ft	any depth
Full bottom coverage	Yes (100%+)	No (< 5 % typical)
Dredging: new work	Recommended	Optional
Dredging: rock cuts	Recommended	Not recommended
Dredging: maintenance (soft matl)	Optional	Recommended
Dredging: payment	Recommended (TIN)	Recommended (AEA)
Beach renourishment surveys	Not recommended	Recommended

Reservoir surveys	Recommended	Optional
Underwater structure investigation	Recommended	Not recommended
Quality control requirements	Critical/demanding	Critical but less effort
Quality assurance test requirements	Critical/demanding	Minimal
Motion sensing required	Yes	No (optional)
Code DGPS positioning	Yes	Yes
Carrier RTK positioning	Recommended	Recommended
Cost: Acoustic system	\$200k to \$400k	\$20k to \$70k
Cost: Motion compensation system	\$30k to \$200k	\$0k to \$100k
Cost: Daily crew rate	\$2,000 to \$6,000	\$1,000 to \$2,000
Vessel hull modifications	Significant	Minimal
Field finish capability	Yes (more processing reqd)	Yes (rapid)
Office data processing time	Lengthy data editing	Rapid
Volume computations	Accurate	Interpolated

EM 1110-2-1003
30 Nov 13

THIS PAGE INTENTIONALLY LEFT BLANK

CHAPTER 3

Recommended USACE Accuracy Standards for Federal Navigation Projects

3-1. Purpose and Scope. This chapter provides recommended accuracy standards for USACE hydrographic surveys of federal navigation projects. These standards are summarized in Table 3-1. This chapter, along with Appendix D, describes the Performance Test procedures and Total Propagated Uncertainty methods that are recommended to estimate and report the accuracy of observed depths on navigation projects; in particular, on evaluating the quality of contracted construction dredging clearance and payment surveys. These standards are intended to provide Corps-wide uniformity in specifying and reporting accuracies of surveys performed on navigation and other civil works water control projects.

a. Limitations on prescribed accuracy standards. The procedural and accuracy standards recommended in this manual are designed to reflect current survey positioning methods, acoustic instrumentation systems, calibration practices, and typical bottom conditions encountered at average USACE navigation projects. However, as noted in Chapter 1, it must be recognized that no single accuracy standard will be applicable to every USACE civil works project; therefore, USACE commands should tailor their survey procedures and required accuracies to each specific project. For example, more stringent accuracy requirements should be established for a deep-draft coastal entrance project with tidal influence than those needed for a shallow-draft inland navigation project, or a reservoir sedimentation survey. Likewise, more stringent requirements are typically needed for new work construction in a rock-cut navigation project with a high cost per cubic yard payment rate than for subsequent maintenance dredging of soft material. Underwater scour surveys adjacent to locks, dams, bridges, and hydropower projects will require the most demanding accuracy standards. Conversely, it is unlikely the nominal accuracy standards recommended in this manual will be achievable in projects containing fluid mud, suspended sediment, extreme tidal ranges, or with highly irregular topography and geomorphology. In summary, accuracy standards, and related quality control and quality assurance performance tests outlined in this manual, must be considered as only recommended guidance.

b. Standards for other civil works projects. Recommended accuracy and performance criteria for other types of civil works surveys (e.g., reservoirs, locks and dams, revetments, breakwaters, underwater structure investigations, beach renourishment, etc.) are detailed in chapters covering those projects. However, in most cases, the recommended standards for navigation surveys will be applicable to many of these other civil works projects.

c. Survey calibration and testing. Recommended quality control and quality assurance procedural methods for acoustic depth measurement and positioning are covered in separate chapters in this manual—e.g., Chapter 4 (single beam), Chapter 5 (multi-transducer), Chapter 6 (multibeam), and Chapter 7 (GPS positioning and inertial orientation systems).

d. Use of standards. USACE organizational elements requesting hydrographic surveys should utilize these standards in requesting and specifying in-house or contracted surveys. However, in-house survey sections should be consulted to ensure that the required accuracy specifications for a particular project are realistic and achievable; and whether or not these accuracies should be independently tested for compliance in the field. This chapter may also be referenced in Corps hired-labor or A-E survey specifications, and in construction dredging contracts.

e. Supplemental references. The following references should be consulted in conjunction with this chapter.

(1) EM 1110-2-6056. "Standards and Procedures for Referencing Project Elevation Grades to Nationwide Vertical Datums."

(2) "IHO Standards for Hydrographic Surveys—SP 44, 5th Edition." (IHO 2008).

3-2. Discussion. No measured depth is without error. Unlike visual topographic or construction survey measurements, acoustic depths are indirectly measured using various forms and combinations of time difference (amplitude detection), phase detection, or phase difference (interferometric) measurements. These measurement methods contain varying magnitudes of acoustic reflectivity and signal/noise that must be resolved into a "best estimate" of the depth. Spatial variations in bottom soil materials will also vary the recorded depth returns. Thus, an absolute "accuracy" of a depth measurement at a given point is rarely, if ever, known. In addition, hydrographic survey depth measurements are referenced to the local water surface, which will typically have tidal or river stage modeling uncertainties (biases) relative to a distant reference gage and datum. Vessel motion, orientation, and acceleration (i.e., velocity, roll, pitch, yaw, and heave) require corrections that include additional uncertainties. Also, numerous corrections must be applied to the resolved depth to account for often significant variables in the measurement system (e.g., latencies) and speed of sound or refraction variations in the water column. The total propagated magnitude of all the above random and systematic "errors" is termed "uncertainty," or "Total Propagated Uncertainty" (TPU). TPU is estimated using mean square error propagation techniques, resulting in a "±" root mean square (RMS) error estimate. This "best estimate" of a depth accuracy can have uncertainties ranging from ±0.2 ft in shallow-draft projects to more than ±1 ft in deep-draft navigation projects; the major uncertainty components being the water surface elevation measurement and geomorphological variations in the project area. The TPU of individual depth measurements is difficult to determine through any testing method; however, the Performance Test procedures described in this manual will often provide a general indication of the TPU.

3-3. Quality Assurance Performance Tests. The QA Performance Test is the primary USACE method by which the quality of a hydrographic survey can be estimated. This test compares depth measurements made over the same point (or many points) by two or more "independent" measurement systems. The test yields an estimate of the biases (i.e., repeatability) between the surveys, and the dispersion (i.e., standard deviation or approximate TPU) between the surveys, as

described below. A Performance Test is not an absolute accuracy or uncertainty assessment. Tests made by the same vessel are not truly independent. In addition, the bottom conditions of a separate Performance Test site may differ from the actual project site. Bottom soil material and topography may also vary within the test site and/or the actual project site. Performance Tests comparing surveys of the same test site by different vessels and measurement systems are more independent and provide better estimates of the statistical repeatability (or reproducibility) and standard deviations. The most representative Performance Test is comparisons between different vessels of entire surveys of the actual project area (e.g., a dredging acceptance section) where thousands of points can be compared—see example at Appendix F. Not all surveys require Performance Tests to estimate their accuracy. If no Performance Test is conducted, then the survey accuracy can be estimated and reported based on error propagation techniques (e.g., TPU)—see Appendix D. Procedures for conducting Performance Tests are covered in Chapters 4 and 6.

a. Performance Test repeatability. Repeatability is defined as the closeness of agreement between successive depth measurements carried out at the same point under similar measurement conditions. The QA Performance Test estimates survey repeatability by computing the mean difference in depths observed between overlapping datasets. Constant differences between surveys over the same point(s) is an indication of potential biases between the surveys. Repeatability or bias is specified and measured as either a "plus" or "minus" quantity, e.g., "+0.06 ft." It is not a " \pm " dispersion statistic. In practice, survey "repeatability" provides an estimate of the resultant quality or accuracy of a survey.

(1) Repeatability is especially critical on dredge measurement and payment surveys. Resultant biases, if large, can adversely impact channel clearance assessment and construction payment. The repeatability measured in the QA Performance Test is, in effect, a quality control check. Repeatability results outside tolerances indicate site or system calibrations are inadequate and should be investigated.

(2) The recommended standards in this manual focus on assessing a survey's repeatability through the use of Performance Tests. It is important to reemphasize that repeatability estimates from Performance Tests are usually specific to a vessel, survey system, and the test site; in other words, they are not always statistically independent tests.

b. Performance Test Standard Deviation. Standard Deviation (or standard error) is a measure of dispersion when multiple depth measurements are made of the same point(s). Performance Tests typically compare the deviations between overlapping datasets (single beam and/or multibeam) in a large area—either over the entire project or in a separate test site. Standard deviation is expressed as a " \pm " deviation at the 95% level. Standard deviation statistics obtained from the same survey vessel should be used with caution in that these are not independent tests. Standard deviations from repeated Performance Test comparisons may often be used as estimates of Total Propagated Uncertainty over a test site or project area, assuming systematic biases have been either eliminated or properly minimized (randomized) through QC

calibrations. In addition, large resultant standard deviations do not necessarily indicate that a survey is "inaccurate"—numerous factors impact dispersions in Performance Test comparisons.

3-4. Total Propagated Uncertainty Accuracy Estimates. TPU is a statistical dispersion estimate based on the total propagation of all random and systematic errors present in a measurement system, from the reference tide/staff gage, through the vessel positioning and motion orientation systems, to the acoustic depth return from the bottom. It is based on a Mean Square Error estimation of the total error budget in a depth measurement, and is usually expressed as a "±" root mean square (RMS) error at the 95% level. TPU is broken down to its horizontal and vertical components—i.e., THU and TVU. Data processing software can estimate TVU and THU for each individual depth observation. Alternatively, an average TPU for a given project site can be estimated (e.g., from Performance Test results). These TPU estimates are dependent on the estimated accuracy of each error component.

a. Survey specifications and accuracy reporting. Since Performance Tests are not performed on most USACE surveys, TPU may be used as a criteria for specifying survey accuracy requirements. Such a specification entails consideration of the error parameters listed in Appendix D. Reported survey accuracies on published drawings would reflect these same estimates. (TPU is increasingly being recognized as a hydrographic measurement accuracy statistic by international standards organizations. Therefore, USACE districts are encouraged to utilize this reporting statistic on published survey drawings.)

b. TPU estimates from Performance Tests. The TPU (and TVU or THU) of a hydrographic survey usually cannot be tested in practice—it is estimated based on assumed error propagation. However, as noted above, Performance Tests may yield, over the long term, a good estimate of an average TPU at a project site. (Note that TPU deviation estimates do not provide survey bias assessments. These biases can only be evaluated by Performance Tests in the field.)

c. Examples for estimating TPU in navigation projects are shown in Appendix D. Refer also to Section 5 of "NOS Hydrographic Surveys Specifications and Deliverables" (NOS 2011) and Special Publication No. 44, "IHO Standards for Hydrographic Surveys," (IHO 2008) for additional discussions on TPU and error propagation estimates.

3-5. Recommended USACE Depth Accuracy Standards for Engineering and Construction Surveys. Table 3-1 contains recommended standards for hydrographic surveys of various types of navigation projects. These standards are based on typical project conditions and average results from USACE historical performance tests on coastal projects; therefore, they shall not be considered as absolute Corps-wide specifications. The standard deviations will likely be met on shallow draft projects in confined (calm) waters. They may not be easily met on deep-draft projects with adverse environmental or bottom conditions. As such, these standards should be considered as recommended guidance that may be modified to a specific project site condition. Additional accuracy and performance guidance for specific projects are outlined in other chapters and appendices in this manual. This additional guidance includes such items as quality control calibration requirements, vessel positioning and orientation criteria, acoustic return

assessment, data processing and bin sizes, representative depth selection, depth rounding, volume computation methods, and depth metadata reporting.

a. Specifying required survey accuracy. When specifying that survey depth measurements should meet a required "accuracy" to some " \pm " dispersion level, it is essential that the statistical measurement criteria be precisely defined, along with the process by which it will be confirmed or tested. If no confirmation tests of the resultant accuracy are performed (and these tests are not often performed in practice), then it can only be stated that the survey should be performed using quality control procedures that will "likely" or "probably" meet the desired (or intended) standard in Table 3-1, or alternatively an estimated TPU measure. On critical dredge measurement, clearance, and payment surveys, specifications should require that quality assurance Performance Tests be performed to assess the existence of any biases in the observations—i.e., "repeatability"—and the dispersion (standard deviations) in the measurements.

b. Unachievable accuracies. A desired (required) accuracy standard may or may not be achievable in practice due to varying or adverse project conditions. For example, a specified ± 0.8 ft depth accuracy standard may be easily achievable on a federal navigation project in the Gulf of Mexico with a 1 ft tide range but is likely difficult to meet on the Pacific Columbia River Bar entrance channel with a 6-ft tide range and 10 ft swells. Thus, any nominal accuracy standard (such as those in Table 3-1) must be modified to meet "real-world" project conditions.

c. FGDC accuracy reporting guidance. Most traditional mapping accuracy standards, such as those prescribed by the Federal Geographic Data Committee (FGDC), require testing measurements against an independent source of higher accuracy. Independent sources of higher accuracy are rarely available for testing hydrographic surveys, other than in some inland districts with lock chambers. These FGDC standards do allow for reporting untested data accuracies if quality survey procedures were used that would likely meet the estimated accuracy. These FGDC standards state "regardless of whether the data was tested by an independent source of higher accuracy, or evaluated for accuracy by alternative means, provide a complete description on how the values were determined in metadata, as appropriate to dataset spatial characteristics." Performance Tests and TPU accuracy estimates would be considered as a FGDC "alternative means" evaluations.

d. Accuracy statements on drawings. Distributed drawings, plans, reports, studies, databases, and related metadata documents containing channel depth or clearance data should contain a statement (note) attesting to the tested (Performance Test) or estimated (TPU) accuracy of the survey data. On construction dredging projects, this accuracy statement will normally be based on results from actual or historical Performance Tests. If no Performance Tests were performed an estimated TPU may be indicated in the accuracy statement.

Table 3-1. Recommended Depth Accuracy Standards for Corps of Engineers Surveys of Federal Navigation Projects based on Performance Test Results. ¹

Project	Typical ² Repeatability (feet)	Typical ³ Standard Deviation (± feet at 95%)
Coastal Deep Draft Projects (15>d<75 ft):		
Dredge measurement & payment surveys		
Channel clearance/acceptance		
Project condition surveys		
Maintenance Dredging (soft sand/silt bottom)	0.3 ft	±0.8 ft
New Work or Rock Cuts ⁴	0.2 ft	±0.8 ft
Coastal Shallow Draft Projects (d<15 ft)	0.3 ft	±0.8 ft
Inland Navigation Projects (d<15 ft)	0.3 ft	±0.5 ft

NOTES:

1. These standards are recommended "target" tolerances that may be specified for the various navigation projects listed. They are primarily applicable to dredging measurement and payment surveys where Performance Tests are conducted. They are representative of "typical" or "average" USACE navigation projects, and should be modified to meet specific project conditions and survey capabilities; as such, they are not mandatory standards. Refer to the discussions and definitions in this chapter and in Appendix D.
2. Refer to Chapters 4 and 6 for performance testing procedures and survey bias assessment.
3. Standard Deviations are usually derived from Performance Tests. In certain cases, these standards may be considered nearly equivalent to Total Vertical Uncertainty; and, as such, they are an IHO "Special Order" standard.
4. These recommended tolerances may be difficult to meet on some single-beam system cross-line Performance Tests if an insufficient number of comparison points are tested.

If no Performance Test was conducted on a specific dredging project, then the drawing (metadata file) should note whether these target standards were likely met based on historical (long-term) repeated Performance Test capabilities of the vessel/system. Alternatively, for any dredging or project condition survey, an estimated TPU (or IHO Standard) may be noted.

Accuracy, QC, and QA performance criteria for coastal engineering and other civil works water control projects are found in their respective chapters.

3-6. Horizontal Accuracy Standards. Specifying that a hydrographic survey depth measurement meet some required horizontal accuracy standard is difficult in practice. The horizontal positioning uncertainty of a measured depth is a function of various factors, primarily the GPS positioning method (code DGPS or carrier RTK), multibeam outer beam array limits, acoustic footprint size, and vessel motion compensation employed. No specific Performance Test type procedure exists to quantify the resultant horizontal accuracy of a depth observation—positional uncertainties are buried within the error budget of the depth results in a traditional Performance Test, and any standards based on that test. Thus, horizontal accuracies can only be roughly estimated using TPU techniques described in Appendix D.

a. Reporting depth horizontal accuracy. Drawings and metadata files should indicate the positioning method used on the survey, including the estimated accuracy of that system (which may not necessarily be the horizontal accuracy of the propagated depth on the bottom). For survey drawings furnished to the public, or other federal agencies, estimated horizontal accuracies of depth measurements may be noted as meeting one of the IHO "Total Horizontal Uncertainty" (THU) standards. This untested estimate can be based on the type of project (e.g., IHO Special Order or Order 1a—a 2 m standard), the positioning system used, and outer beam footprint size on a multibeam system.

b. Topographic feature accuracy. Horizontal accuracy standards for topographic features near navigation or other civil works structures are specified in EM 1110-2-1005, Topographic Surveying. Topographic and planimetric features shown on USACE navigation drawings or charts should be located to accuracies consistent with the project drawings. Feature positional accuracies are estimated and reported at the 95% RMS level. Fixed planimetric features include dredging limits, rights-of-way, harbor lines, bulkheads, piers, etc. Fixed navigation aids are lighthouses, ranges, beacons, daymarks, etc. In general, code-phase DGPS accuracy is sufficient for positioning fixed navigational features; however, it is not applicable to design or construction of marine facilities or structures. Contract plans for such facilities should require conventional topographic mapping accuracies.

3-7. IHO Standards for Hydrographic Surveys. IHO hydrographic survey accuracy standards (IHO 2008) were developed specifically for nautical charting purposes. They do not necessarily apply to the engineering and construction (dredging) survey standards in this manual. IHO standards may be specified for (and reported on) coastal project condition survey drawings of federal navigation projects that are furnished to NOAA and the general public. IHO standards are based on TPU estimates, which, as noted above, may be difficult to test or substantiate.

a. IHO Special Order (areas where under-keel clearance is critical) and Order 1a (areas shallower than 100 meters where under-keel clearance is less critical but features of concern to surface shipping may exist) are most applicable to USACE surveys of shallow-draft and deep-draft navigation projects. Most USACE surveys of federal navigation projects fall within the IHO Special Order standard.

EM 1110-2-1003

30 Nov 13

b. If an IHO standard is noted on a USACE drawing, then it should clearly indicate that a survey was performed to meet a particular IHO accuracy standard and that this was not proven by testing.

c. IHO standards have other Orders and specifications that may be of use in some USACE survey specifications for non-navigation projects. These other IHO Orders include specifications for total vertical uncertainty (TVU), total horizontal uncertainty (THU), bottom coverage (line spacing) requirements, and object detection requirements. IHO standards may also be referenced for surveys of deep-water disposal sites.

d. A complete copy of the current IHO S-44 Standard is at Appendix E.

CHAPTER 4

Single Beam Depth Measurement Systems

4-1. General Scope and Applications. Single beam acoustic depth sounding is the most widely used depth measurement technique in USACE for surveying river and harbor navigation projects. Single beam echo sounders were first used in the Corps back in the 1930s but did not replace reliance on manual depth measurement methods until the 1950s or 1960s. A variety of single beam depth measurement systems are used throughout the Corps, depending on project conditions and depths. These include single frequency systems, dual frequency systems, and multiple transducer channel sweep systems. Although multibeam systems are increasingly being used for surveys of deep-draft projects, single beam systems are still primarily used on shallow draft inland navigation projects. This chapter covers the principles of single beam acoustic depth measurement systems. It especially focuses on the critical quality control calibrations and quality assurance tests required for single beam echo sounding equipment.

4-2. References. This chapter only briefly discusses the theory and physical principles of underwater sound propagation, including transmission and reception characteristics of transducers. It only generally outlines the details in configuring single beam systems for data collection and subsequent data processing, editing, and thinning procedures. These topics are covered in more detail in the following technical publications that will be referenced throughout this chapter.

- a. "Manual on Hydrography" (IHO 2005); Chapter 3, "Depth Determination."
- b. "Multibeam Sonar Theory of Operation" (L-3 SeaBeam 2000).
- c. "R2Sonic Operation Manual," (R2Sonic 2010).
- d. "Odom Echotrac MKIII User Manual," (Odom 2008).
- e. "HYPACK Hydrographic Survey Software User Manual," (HYPACK 2011).

SECTION I

Principles of Acoustic Single Beam Depth Measurement

4-3. Overview. Acoustic depth measurement systems measure the elapsed time that an acoustic energy pulse takes to travel from a generating transducer to the waterway bottom and back. This is illustrated in Figure 4-1 where the measured depth "d" is between the transducer and a point on the acoustically reflective bottom. The travel time "t" of the acoustic pulse depends on the velocity of propagation "v" in the water column. If the velocity of sound in the water column is known, the observed depth "d" from the transducer to the bottom can be computed from the measured travel time of the pulse. Given the vessel draft "d_r" and datum correction "r" the corrected depth "D" can be expressed by the following general formula:

Depth corrected to reference datum: $D = \frac{1}{2} (v \cdot t) + k + d_r + r$ (Eq 4-1)

where:

- v = average velocity of sound in the water column
- t = measured elapsed travel time from transducer to bottom and back to transducer
- k = system index constant
- d_r = distance from reference water surface to transducer (draft)
- r = reference datum correction ("tide" or "stage" correction)

The above parameters must be periodically monitored for variations during a survey. This entails periodic calibration of the echo sounder, such as "bar checks" and "sound velocity casts."

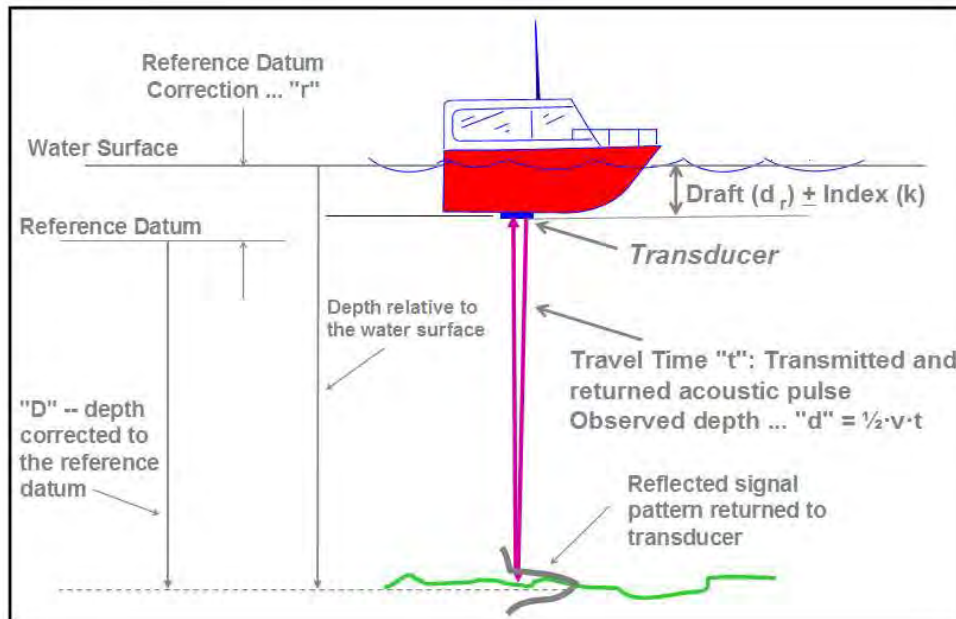

Figure 4-1. Acoustic depth measurement.

a. Travel time measurement. The travel time "t" of the sound pulse is measured either electronically in a depth digitizing device or mechanically (graphically) on an older analog recording type instrument. The accuracy of the absolute time measurement generally varies with depth. This is due to signal attenuation, noise, and the ability of the measurement circuitry to correlate the outgoing and incoming pulses. In addition, the acoustic reflectivity (impedance) characteristics of the target bottom soil material can significantly impact the sharpness of the returning pulse, and consequently the depth measurement accuracy. The irregularity of the reflected pulse causes uncertainty in the overall time measurement process. There is no practical calibration process for minimizing this error. The nominal "precision" (not accuracy) of echo sounding time measurement is usually rated by manufacturers at ± 0.1 ft plus 0.1 to 0.5 % of the depth. This equates to a precision range of ± 0.15 to ± 0.35 ft in a 50-ft depth and is independent of the acoustic reflection characteristics of the bottom.

b. Velocity of sound in water. Determining the sound velocity " v " is perhaps the most critical factor in using acoustic depth sounders.¹ The sound velocity in water varies with the density and elastic properties of the water—see IHO 2005. These physical properties are, for typical river and harbor project depths, primarily a function of the water temperature and suspended or dissolved contents, e.g., salinity. Due to these effects, the sound velocity can range from 4,600 to 5,000 ft/sec. Since most river and harbor projects can exhibit large variations in temperature and/or salinity with depth, the velocity of the projected sound wave will not be constant over the distance from the boat's transducer to the bottom and back. The effect of this variation is significant. A temperature change of 10 deg F will change the velocity by as much as 75 ft/sec, or approximately 0.8 ft in 50 ft of water. A 10-ppt salinity change can vary the velocity by some 40 ft/sec, or approximately 0.4 ft in 50 ft. For practical single beam echo sounding work in shallow water, an average velocity of sound through the water column is usually assumed (by calibration). Use of an average sound velocity may not be valid in coastal projects subject to freshwater runoff, nor will it be constant over the entire project area surveyed. The sound velocity may be measured directly using a "velocity probe" or indirectly by a "bar check" calibration. A velocity probe can measure sound velocities at each point in the water column (e.g., every foot). These data can be used to compute an average velocity over the entire column or the recorded velocities at each increment can be used correct the observed depths. The bar check measures actual depths relative to the recorded depths on an echo sounder. Sound velocity determination is much more critical on multibeam systems--especially on the transducer face and for outer beam refraction correction.

c. Transducer draft and index constant. The transducer draft (" d_r ") and index constant (" k ") must be applied to the reduced time distance to obtain the corrected depth from the reference water surface. The index constant contains any electrical and/or mechanical delays inherent in the measuring system, including return signal threshold detection variations. It also contains any constant correction due to the change in velocity between the upper surface level and that used as an average for the project depth range. For this reason, the apparent "draft" setting or reading on a digital or analog record is not necessarily the actual draft of the transducer, as would be obtained by physical measurement between the water surface and transducer. Also, the vessel draft is not the same as the transducer draft because the vessel draft may be measured relative to skegs or other points on the hull. The only effective method of determining the combined constants in Equation 4-1 is by a bar check calibration. The reference water surface datum correction " r " may need to be further adjusted based on real-time river/lake stage, pool, or tidal observations. The various corrections required in an acoustic depth measurement are discussed in subsequent sections in this chapter.

4-4. Single Beam Transducer and Frequency Specifications. A transducer converts electronic energy to acoustical pulses and vice versa. They operate by converting electrical energy into mechanical energy, i.e. transducers convert electrical pulses from a signal generator to

¹ Sound velocity is more correctly a scalar quantity (speed), but the term "velocity" is more commonly used in practice. Most single beam echo sounders have "speed of sound" controls to set an average sound speed/velocity.

longitudinal vibrations which propagate into the water column as a pressure wave. During the reception, reciprocally, the pressure waves are converted into electrical signals (IHO 2005).

a. Frequency selection. The type of transducer used is a major determining factor in the adequacy of a depth measurement. The optimum transducer frequency is highly project- or site-dependent. Throughout USACE river and harbor projects, a variety of frequencies have been used. These frequencies generally range between 20 kHz and 1,000 kHz. Each frequency/transducer has physical characteristics that particularly suit it to an individual application or project site. In general, higher frequency transducers (100 kHz to 1,000 kHz) will provide more precise depth measurement due to both the frequency characteristics and more-concentrated (i.e., narrow) beam widths. However, lower frequencies are less subject to attenuation, which allows greater depth measurement and penetration of suspended sediments. Although greater depth measurement is not required for river and harbor projects, the ability to penetrate suspended sediment is a decided asset, especially in performing surveys for dredging projects. A major disadvantage of higher frequency transducers is that there is high signal attenuation with depth, and low specific gravity suspended sediments (fluff) or bottom vegetation will readily reflect the signal. High frequency transducers are not recommended in areas where suspended sediment layers commonly occur, or where bottom vegetation may obscure the desired “pay” grade. In such areas, frequencies ranging between 20 kHz and 50 kHz are typically employed for payment determination.

b. Beam width selection. Transducers are designed with varying beam width patterns—see Figure 4-2. Most USACE applications require narrow beam widths in that the array is more focused, resulting in a smaller footprint and better resolution. Narrow beam transducers (i.e. less than 8 deg) may require roll and pitch correction since the more-focused beam will measure a slope distance at non-vertical points. Narrow beam transducers should be obtained with minimum side lobes. Lower frequency transducers (below 40 kHz) tend to have larger beam widths, which can cause distortion and smoothing of features in irregular bottoms or on side slopes.

c. Shoal or object strike detection. Far more complex is the effect of transducer frequency on the detection of certain-size objects on the bottom. Detection of blasted rock fragments or other hazardous objects above project grade is a difficult process with traditional single-beam echo sounders, regardless of the frequency used. Generally, wider-beam transducers may be more suited for strike detection than narrow-beam transducers. However, the sounding system's threshold detection settings, gate settings, display methods, etc., are also critical to strike detection. Vertically mounted, narrow-beam transducers (either single hull-mounted or boom multi-transducer “sweep” systems) may not be the best configuration for providing optimum energy return from small underwater strikes; notwithstanding their small acoustical footprint. Side-looking multibeam systems and side-scanning sonar will often provide better returns from such stealth-type objects.

d. 200 kHz narrow beam transducers. The most commonly employed transducer frequency recommended for use on typical Corps river and harbor navigation projects is 200-208 kHz. Transducers operating at this frequency are usually narrow-beamed (between 1.5 deg and 8

deg at the -3 dB points) to provide more accurate bottom detailing. A 3-deg beam width is most commonly used in USACE. Narrower beam widths are recommended for projects with relatively hard, smooth grades, such as rock cuts or sand bottoms. The 200-208 kHz ($\pm 10\%$)

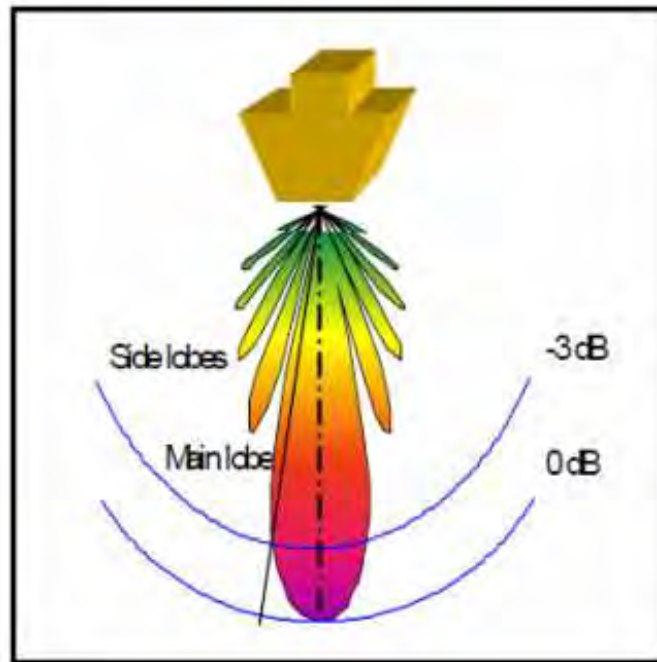

Figure 4-2. Transducer beam pattern. Sensitivities are normally measured at the - 3 dB half-power points. (IHO 2005).

frequency is not a mandatory USACE frequency standard, nor is any particular beam width. Local conditions and unique project requirements will dictate the optimum type of survey system and frequency to be used. However, for navigation and dredge payment surveys, the acoustic survey system and/or transducer frequency should be constant throughout the project duration—and clearly identified in construction contract specifications. Multiple frequency systems may be used for analyzing sediment layers of varying densities-- typically using 200 kHz and 28 kHz dual frequency sounders.

4-5. Echo-Sounder Control Settings. Single beam echo sounders have power, gain, and other signal amplitude detection processing adjustments that need to be tuned to the local project conditions. It is important to understand these settings on echo sounders—in particular, how their adjustment can alter the measured depth. The following section explains some of the common controls found on many echo-sounders—it is primarily excerpted from portions of IHO 2005 (Manual on Hydrography) and from ODOM 2008 ("Odom Echotrac MKIII User Manual"). Not all of the controls listed below are available on every echo sounder.

a. Transmitted power. The operating range of the echo sounder depends on pulse length, frequency, and transmitted power. To optimize the use of the echo sounder, the transmitted

power should be kept at the lowest values consummate with adequate detection. Increases in power will result in high levels of echoes but also in higher reverberation levels, creating a poor record. Most echo sounders have a power setting control that can be adjusted depending on the project depth and bottom condition. The Odom Echotrac MKIII also has an automatic transmit power setting ("Tx") that varies the power based on a maximum depth setting.

b. Gain and Automatic Gain Control (AGC). Gain is the amplification of the return echo signal. On older analog echo sounders gain was synonymous with the "sensitivity" control. The amplification of the signal also amplifies the noise and consequently the data record may be confused. It is recommended that the receive gain be adjusted according to the seabed type and to the transmission power (IHO 2005). For example, the Odom MKIII echo sounder has a receive gain control ("Rx Gain") that adjusts the amount of attenuation or amplification applied to the return echo. Covering a range of approximately -20dB gain (20dB of attenuation) at the minimum position to +40dB gain at the highest position, the selected amount of gain or attenuation is applied in addition to the internal automatic TVG (time varied gain). In the "Automatic" position, the amount of amplification or attenuation applied to the return signal is determined by the Digital Signal Processor (DSP). Located inside each transceiver module, the DSP attempts to keep the bottom return at between 80 and 90 % of full scale without allowing the signal to be over amplified and to saturate the receiver. Thus, AGC adjusts the differing signal intensities returned by echos from hard rock and soft silt. The 20Log Time Varied Gain curve is the generally accepted standard in single beam vertical echo sounders and the default value for the Odom MKIII. The 20Log curve includes compensation for both spherical spreading loss and absorption losses. (Odom 2008).

c. Time Varied Gain (TVG). The received signal is amplified as a function of time (depth) such that similar echos are generated and digitized for varying depths. TVG removes transmission loss from acoustic absorption and beam spreading.

d. Pulse length. The pulse length is usually selected automatically as a function of the operating range. The pulse length determines the vertical resolution of the echo sounder--short pulses are necessary for a better resolution. It may be necessary to increase the pulse length in areas with poor reflectivity or with steep slopes. In shallow waters, where resolution is more important, short pulses must be used. This will reduce the probability of false echoes due to strong reverberation. Larger pulse lengths have poorer object resolution. Two objects inside a narrow beam will be recorded as a signal target if they are less than half a pulse length apart; they will be resolved as two separate echoes if they are more than half a pulse length apart.

e. Velocity/Speed of Sound control. This is the nominal value of sound velocity that normally will be set to the average on the recorder's "speed of sound" control, as obtained from a Velocity Probe cast or a Bar Check. Usually this average speed of sound will be used in subsequent processing. If there are large velocity changes in the water column, an average velocity of sound is not recommend to correct the depths at varying elevations—use a table of measured velocities in the data acquisition software. When significant water velocity changes were observed, during post-processing the depths can be corrected by applying the actual sound velocity profile obtained from the cast or the recorded bar check differences at varying depths.

f. Resolution. This is the ability to separate returns from two or more objects close together; it is generally expressed as the minimum distance between two objects that can be separated.

g. Ping rate. On an Odom MKIII this parameter refers to the pulse repetition rate of the sounder. The default is "AUTO," that is, the sounder "pings" as rapidly as possible as dictated by the end of scale value, the velocity of sound, and a certain amount of processor overhead time. Selection of a fixed number of soundings per second from a minimum of 1 per second to a maximum of 20 per second is also possible (Odom 2008).

h. Maximum and minimum depth gates. Gate controls can be set to blank out signal returns outside the working depths, due to noise or other sources. Additional noise and gate filters can be applied during post-processing—e.g., in the HYPACK Single Beam Editor.

i. Threshold settings. This parameter sets the digitizer threshold, or the time (i.e., depth) on the return signal where the return is registered—see Figure 4-3. Many single-beam manufacturers have a fixed threshold that is internally calibrated such that the recorded depth represents a fixed 60% ($\pm 10\%$) of the maximum return echo voltage available for a saturated echo. The transmitted power and/or received sensitivity settings can also vary the shape of the signal, and thus the measured depth. The Odom MKIII provides a variable threshold option where the digitizer will only detect the signal at the point it exceeds the percentage entered. The Odom MKIII default of 25% is the threshold that can be seen on the paper chart. A higher percentage threshold should be used to detect a hard bottom in sea grass conditions. When the Odom MKIII threshold is set to "none" the digitizer will detect the signal with the highest energy--use this setting only in very deep depth conditions. (Odom 2008).

4-6. Single Beam Power and Receiver Sensitivity Effects. The proper setting of the echo sounder's power and receive gain (or sensitivity) controls (Figure 4-4) must be maintained when conducting single beam hydrographic surveys. In soft or unconsolidated material, depth biases upwards of 1 ft can be induced by varying these settings. The adverse impact of such constant depth errors on channel clearance and payment is obvious. Thus, it is critical to maintain constant power and gain settings throughout the survey; including the bar check calibration. In practice this is usually not possible—especially on channel cross-sections where the upslope depth is significantly shallower than the channel depth, or in varying hard and soft material along the section. In these cases, the power and/or gain may have to be adjusted to ensure a valid depth is recorded throughout a cross-section of varying side slope and channel depths. When these adjustments must be made, this fact should be noted in the field book or survey log.

a. Typically, survey sounders take a point for the sounding depth that is at 60% of the maximum return echo voltage available for a saturated echo (Figure 4-3). If the return echo is nearly vertical, there will be no time or depth delay from the point where the received echo starts to return from the bottom and the point where it reaches the 60% of maximum which is the digitized depth point on the echo. If the receiver gain setting is too low, the received echo will have a more rounded shape. If the gain is quite low, the slope of the echo can induce a

significant difference in time between when the echo is first being received to when the 60% point is reached, resulting in a depth error showing a deeper depth than the true bottom.

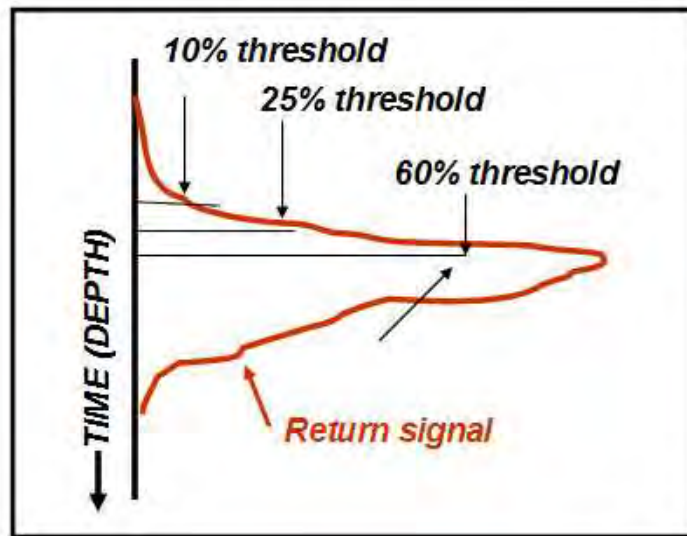

Figure 4-3. Digitizer receive gain and threshold settings. The sharper the return signal the less impact the settings have on the digitized depth. Transmit power variations may also modify the shape of the return signal, and depth measurement.



Figure 4-4. Odom MKIII transmit (TX Power) and receive power (RX Gain) adjustments. Maintaining consistency in these adjustment settings is critical in ensuring survey repeatability in soft material.

b. The correct gain setting is reached when the top most color of the echo trace on the sounders display is at its maximum, typically red on some digital screen displays. It should stay at this color without breaking up or changing to the next color in the palette—approximately one third of the total echo trace. If a bottom tracking line is displayed, the line should be fairly stable without jumping up and down while on a flat bottom. This can also be an indicator of a weak echo as the slope of curve is changing as the weak echo fades, causing the 60% point and resulting depth indication to move around. Digital signal returns can be viewed on graphical displays as shown in Figure 4-5.

c. Caution must also be used in not setting the gain too high, as this results in false soundings from fish targets, vegetation, suspended sediments, and noise in the water column, which can reach a 60% level and become erroneous depths—i.e., shallower than the grade.

d. In soft material, varied power and gain settings should be tested in the deeper part of the channel to determine if significant depth differences result from small setting changes. If so, then maintaining records of these settings will be critical for survey measurement & payment repeatability in these areas. In these soft bottom areas, obtaining repeatability between two different survey vessels (echo sounders) will be difficult, at best. Different echo sounders with different power/gain settings will yield constant depth biases over the same area, resulting in differing clearance assessment and pay quantities. In these problematic soft sediment channels, it is recommended that the same vessel (echo sounder) be used for all payment and clearance surveys.

SECTION II

Single Beam Echo Sounders and Auxiliary Sensors

4-7. Single Beam Echo Sounding Evolution in USACE. Prior to the 1970s, most USACE districts employed mechanical analog depth recorders. The most common models used were Bludworth and the Raytheon DE 719 (Figure 4-6). These devices marked the continuous depth profile on a pre-printed graph paper using a rotating stylus mechanism. The speed of the rotating mechanical stylus was a function of water depth and velocity of sound. Unfortunately, the rotational speed of the mechanical recorders was often unstable and required constant calibration and realignment. Few, if any, of these mechanical analog recording systems are still used in the Corps.

a. In the 1970s, USACE districts began to acquire digital depth recording systems. These systems marked analog (profile) depths directly on blank thermal recording paper; thus eliminating most of the alignment errors common in mechanical recorders. Digital depth data could also be sent to a data logging device where it was correlated with positioning data input. All modern depth measurement systems are now configured to output measured depths to data recording software where they can be time tagged with position, water level, and motion sensing data. Options available for real-time (or post-processed) cross-section display include both digital and hard copy.

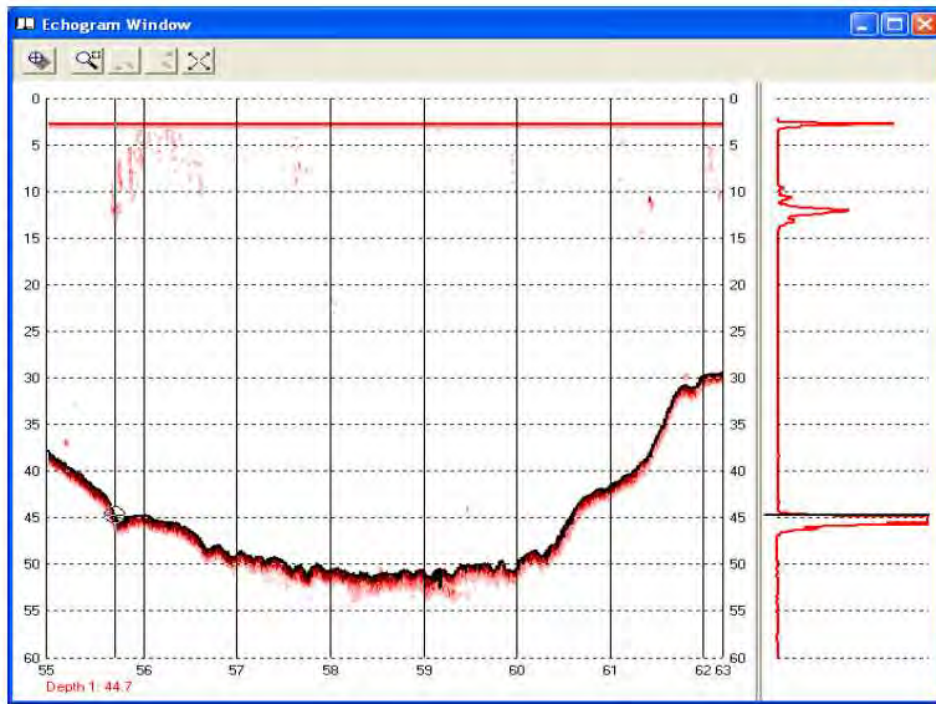

Figure 4-5. Digitized depth signal return display at a selected point along a cross-section.

b. Figure 4-7 depicts some of the more common digital sounding units used by Corps districts. Detailed descriptions and specifications for these (and newer) units may be obtained from the manufacturer's operating manuals and/or other literature.

4-8. Single Beam Transducer Mounting Locations. The transducer for a single beam echo sounder should ideally be mounted in the hull nearly amidships and as near as possible to the vessel's fore and aft center of rotation. The transducer should be permanently located in a frame or transducer well adjacent to the vessel's keel. Over-the-side, bow, and stern mounts are acceptable but not recommended. These external mounts may exhibit significant dynamic motion on small vessels and may require heave-pitch-roll motion correction. The positioning system's GPS antenna should preferably be located directly over the transducer--any X-Y-Z offsets (lever arms) must be accurately measured and input into processing software. Requirements for inertial motion correction will be determined based on the type of vessel and typical sea conditions encountered. These motion corrections may not be significant in relatively calm inland navigation projects; however, in coastal projects, motion correction may be essential.

4-9. Motion Correction on Single Beam Systems--Vessel Heave, Roll, Pitch, and Yaw. Correcting observed depths for the superimposed effects of vessel roll, pitch, yaw, and heave was once perhaps the most difficult aspect of hydrographic surveying. Along with tide/stage,

these effects are a major error component in hydrographic surveying. Since vessel roll, pitch, yaw, and heave conditions can occur simultaneously and at different periods, either visual or automated interpretation of a single beam analog profile record to reduce these errors is an



Figure 4-6. Raytheon DE 719 analog-recording portable echo sounder ca 1978. (Jacksonville District)

imprecise process, at best. Vessel heave is the major error component of the four listed motions. (Yaw is usually not significant—and not corrected—on single-beam installations if the positioning antenna is located vertically inline with the transducer.) Since the mid 1990s, affordable and accurate motion compensation sensors have significantly reduced (but not eliminated) these errors. Many districts have now incorporated motion compensation into single beam systems. Motion compensation (heave-pitch-roll) is essential on critical dredging measurement and payment surveys and strongly recommended for all other surveys where adverse sea conditions can affect the quality of the recorded data.

a. Interpretation of single beam recorded depths without motion compensation. The impact of lateral vessel roll and fore-and-aft pitch of the vessel are more pronounced when narrow-beam transducers are employed because the sounding cone becomes non-vertical and measures a longer slope distance. Up and down vertical heave reflects the wave height. Heave is superimposed with roll and pitch on the observed depth. Heave values typically can range up to 2 to 4 ft whereas roll/pitch depth errors are much smaller--e.g., less than 1 ft. Interpretation of the effects of all three potential motions on an analog recording requires skill and experience with the vessel motion at the time of the survey. The apparent smoothing of undulations on the graphical record are not always interpolated correctly, depending on the vessel's course relative to the seas, vessel size, vessel characteristics, and wave height. On an irregular bottom, it is extremely difficult to separate vessel motions from the bottom undulations. Digitally recorded depths do not allow for any human interpretation or smoothing of undulations due to heave, pitch, and roll.



Figure 4-7. Typical single-beam echo sounders used on USACE projects ca 2002.

(1) Unless reliable motion compensation devices are used, the only practical method of minimizing vessel motion effects is to limit the maximum allowable sea states under which a particular type of survey may be performed. Such limitations are highly subjective and can have significant economic impacts, due either to delayed survey work or to inaccurate payment when a survey is performed under adverse conditions. Maximum sea state limitations must also factor in the size and relative stability of the survey vessel, along with the effects of the prevailing wave direction relative to the survey lines or cross sections. Procuring larger vessels to minimize roll, pitch, and heave is likewise no longer economically justified given the small cost of motion compensators. Thus, a simple maximum allowable wave height criterion is difficult to definitively specify.

(2) An on-site assessment of the potential data adequacy must be performed since so many variables are involved. If the effects of vessel motion appear to be degrading the desired (and acceptable, from a contract performance measurement standpoint) survey quality after the on-site assessment is performed, the on-site survey party chief should make the decision to postpone the survey.

(3) A subjective judgment on the effects of excessive vessel motion to a survey's adequacy must also consider the type of survey. One-half foot seas may be the maximum tolerable limit for performing a final acceptance survey or sweep on high-unit-price rock excavation work, whereas 1-ft seas or larger might have been tolerable for the initial pre-construction survey of this same project. Any workable sea state may be tolerated for an intermediate progress payment survey of this project. No maximum sea state limits need be imposed on performing less critical non-navigation surveys--the only tolerance to be considered is the ability of the vessel, equipment, and personnel to collect reliable data.

(4) The NOAA Office of Coast Survey (OCS) "Field Procedures Manual" (OCS 2011) provides the following guidance regarding the need for motion compensation equipment:

"[If] the magnitude of vessel roll and pitch is less than the sonar beam width, these attitude characteristics will have little effect on sounding accuracy and their application to vertical single beam data is not required by OCS. However, to maintain data quality in sea states where vessel roll and pitch angles exceed sonar beam width, OCS recommends that an external sensor be used to record heave data for application during post-processing. If a heave sensor is not employed, the vertical single beam system should be used only when conditions are favorable for minimizing heave bias and data must be scanned for heave artifacts during post-processing. If heave artifacts can be reliably interpreted, they shall be manually removed from the depth data. Data acquisition should be suspended if the heave signature exceeds 0.5 m and a heave sensor is not being used."

(5) Based on the above discussion, use of motion compensation instruments for single-beam surveys is usually recommended in order to maximize data quality and production.

b. Motion stabilization for single beam systems—dredging surveys. To best minimize the adverse effects of vessel motion, single beam systems used for dredging and navigation surveys in rough sea states should be equipped with automated motion compensation—e.g., MRUs, IMUs, and/or POS/MV. Motion compensation is often recommended if the effects of heave, roll, or pitch generate depth errors exceeding ± 0.2 ft. (Note that maintaining heave corrections at the ± 0.2 ft level may be difficult to achieve in heavy seas.) Yaw compensation may or may not be required. Motion compensation may not be necessary in confined, calm waters, such as inland rivers or reservoirs; presuming these corrections are less than ± 0.2 ft. Motion compensation systems are configured to operate in line directly with depth recorders or independently as a real-time input to the survey data acquisition and processing system. Nearly all systems display heave, pitch, and/or roll information in real-time; allowing for operator assessment of the data quality. Motion compensation is then applied either in real-time or during post-processing of data—e.g., in the HYPACK Single Beam Editor software. Raw observed data can be independently corrected for heave, roll, and/or pitch, depending on the magnitude of these correctors.

c. Heave compensation. The major depth error component is heave--the long period up and down motion of the vessel due to wave motion, other vessel wakes, etc. Heave is basically a

function of wave swell and period. Heave errors are normally excessive at coastal entrances and on offshore approach channels--large 65-ft survey boats can typically work in swells up to 3 or 4 feet. Modern heave compensators can effectively record heave movement and smooth out these effects. Heave compensators require internal alignment and stabilization calibrations specified by the manufacturers. Since heave compensators can be subject to constant drifts and "hang ups," continuous monitoring during surveys is required—refer to Chapter 7 in this manual for details on heave compensator operation, minimization of heave drift, true heave, induced heave, and use of inertial-aided RTK heave measurements.

d. Single beam position correction for roll and pitch. The transducer measures depth from the first echo return. The wider the beam, the less effect vessel roll or pitch will have since the transducer beam width falls within the vertical. For narrow beam transducers a slope rather than vertical distance is measured. If roll and pitch is severe--e.g., a 10- to 15-deg roll--the recorded depth will be a longer slope distance. This measurement should either be rejected due to excessive roll/pitch or corrected for slope-to-vertical given the observed roll/pitch angle from a motion sensor. Excessive roll and pitch can also inject position errors in the measured depth. This is caused by the motion of the positioning system antenna relative to the transducer. If the distance between the units is large, roll and/or pitch displaces the transducer. This is usually not significant for most applications but can be corrected with roll/pitch and antenna-transducer offset data. Processing software can provide pitch/roll slope-to-vertical depth correction in addition to correcting for the positional (X-Y) eccentricity of the transducer relative to the positioning antenna.

(1) Roll-pitch effects. On larger vessels--i.e., greater than 26 ft--roll and pitch are usually not excessive under normal working conditions--typically less than 5 deg. However, on smaller vessels (e.g., less than 26 ft) roll or pitch can easily approach or exceed 10 deg in rough seas. The correction for roll and pitch varies with the angle of rotation and depth. However, the beam width of the transducer may be greater than the overall roll or pitch, resulting in the first return still being near vertical. Corrections for roll-pitch may be applied for high frequency narrow beam transducers--similarly to that applied to narrow beams formed by multibeam arrays.

(2) Roll-pitch position displacement correction. Single beam processing systems correct for depth and position variations due to roll or pitch. Using roll-pitch data, the software will correct the depth's X-Y position due to rotation of the antenna-transducer axis, and optionally to compute the X-Y coordinate of the center of the projected (i.e., steered) beam on the bottom. On a large survey vessel with an antenna located 30 ft above the transducer subject to a 10 deg roll or pitch, this would amount to a 5 ft horizontal displacement of the transducer. In a 30-foot project, the center of the beam on the bottom would also be displaced by another 5 ft (approximately) relative to the transducer. The total horizontal displacement of the depth relative to the antenna would then be about 10 ft. A smaller survey boat would normally have a much smaller antenna height (< 10 ft) so the horizontal displacement between the antenna and beam-steered bottom depth would be smaller.

(3) Roll-pitch slope to vertical depth correction. In addition to the antenna-transducer-bottom depth positional displacement correction, the slope-to-vertical correction to depth may

also be computed and applied to the observed depth. The slope-to-vertical depth correction is usually small for typical roll-pitch conditions. Full roll and pitch corrections for single beam systems are performed in the processing software (see HYPACK 2011).

(4) Roll-pitch tolerances for single beam systems. Ideally, roll-pitch depth errors should be kept within tolerable limits--say not greater than 0.2 ft. This can be achieved if maximum allowable roll or pitch is kept less than 10 deg when using a typical 8 deg beam width transducer. On critical deep-draft projects, 5 deg roll-pitch limits would be recommended. In general, roll-pitch exceeding 10 deg is a degraded working environment and overall acoustic data quality is marginal.

e. Yaw. Yaw (or vessel heading) rotation error is not significant for vertical single beam systems if the transducer and positioning system antenna are co-located vertically. If these units are not located vertically, then offset corrections must be applied using vessel heading information. This translates the position to the transducer--it has no effect on the measured depth other than position. A variety of techniques can be used to measure real-time heading: magnetic fluxgate compasses, fiber optic gyrocompasses, inertial systems, and carrier-phase POS/MV.

SECTION III

Single Beam Quality Control Calibrations

Calibration of acoustic sounding instruments is absolutely critical in maintaining quality control of depth measurements. This is primarily due to instabilities or variances in the sound velocity, or to a lesser extent, in the equipment. Failure to perform adequate calibrations, including documentation/certification thereof, can lead to total unacceptance of the survey and any payment associated with it. This section describes the various methods used to calibrate single beam depth measurement equipment. The calibration procedures in this section also apply to multiple transducer sweep systems and, in part, multibeam systems.

4-10. Bar Check Calibration of Single Beam Echo Sounders. The primary echo-sounder depth calibration procedure in USACE is the "bar check." The bar check is recognized throughout the Corps and dredging industry as the standard calibration method for all acoustic depth measurements. The bar check is a quality control procedure. It is not a quality assurance procedure. The bar check is used to minimize the following systematic errors inherent in depth recording systems: instrumental errors—index, mechanical, and electrical; velocity of sound errors due to temperature, salinity, or other suspended or dissolved sediment variations; and dynamic draft fluctuations resulting from varying vessel displacement caused by fuel and personnel loads. The bar check is a flat bar or plate suspended by precisely marked line(s) to a known depth below the water surface and under the transducer. The effect of a varying velocity of sound in the water column is observed by performing a bar check. A series of depth intervals are observed during a bar check, down to the project depth. Any difference between the reference bar depths and the recorded depths represent corrections to be made to any subsequently recorded soundings. The bar check represents the only recognized check on the

quality of a depth recording system. Draft and index variations are also compensated through the use of a bar check calibration. However, in reality, the bar check is not an "absolute" calibration device. It has inherent errors and biases, and may not exhibit the same acoustic reflective properties as the bottom. This primary reference device is also used to periodically check secondary calibration devices, such as a sound velocity meter and a Ross ball check.

a. General procedure. Figure 4-8 characterizes the operation of suspending the bar a known distance below the waterline using calibrated chains. Both a single line calibration plate and a dual line (full beam) bar check device are shown. The bar check must be taken at sufficient intervals to correct any variations in the velocity of sound. Normally, intervals of 5 to 10 feet are adequate, unless the velocity of sound is highly variable. It is again emphasized that a bar check will not correct for variations in acoustic reflectivity, either between the bar and bottom material or between different bottom materials within a project area. The bar check is also not a totally independent reference in that it may contain errors within itself--e.g., wave action interpolations and line marking errors.

b. Bar check apparatus. The suspended bar is constructed of flat stainless steel or aluminum plate welded or bolted to any supporting crosspiece section. The plate should be of sufficient width (typically 8 to 12 inches) to provide an adequate return down to project depth. If the bar length is longer or shorter than the vessel beam (on the measuring deck), a slope line distance error may be present in the cable tagging. Generally the bar should be approximately 1 ft longer than the vessel beam (at the measuring deck point). The reflecting plate need not extend the full length of the bar. Both ends of the bar are rigged with universal-type swivel joints to attach the supporting lines. Each line is zero-referenced from the top of the plate and is marked at either 1- or 5-ft increments. The top surface of the bar plate may optionally be coated with foam, rubber, or other like material that better simulates the acoustic reflectivity properties of the channel bottom. A small (12-in.-diam) steel plate can be used to calibrate over-the-side mounted transducers. The plate is suspended by a single bar check line or lead line. Calibration and/or adjustment are performed in a manner identical with that used for bar check. Special caution must be taken not to change the vessel draft when performing a check on one side or end of the boat.

c. Bar weight. The weight of the bar will be dependent on the types of currents experienced, project depths, and beam of the vessel. A typical bar will range between 40 and 100 lb. In deep-draft projects with large currents, a heavy bar is essential because subsurface currents will pull too light a bar away from the transducer's vertical plane, causing loss of acoustic return or slope error in the check lines. Provisions for adding additional weight to the bottom base of the bar ends may also be needed in strong currents. Increased bar weight may necessitate additional personnel to perform the bar check.

d. Bar check procedures on large vessels. On a larger vessel, the bar is usually deployed off the bow and each end walked aft until abeam of the transducer. Both lines are held at the desired fixed depth increment (visually meaning vessel and water surface motion), and the depth recorder is simultaneously observed, annotated, and/or recalibrated. Vessel alignment should be

held toward the sea to minimize roll. Under adverse wind and current conditions, coupled with a narrow-beam transducer, maintaining vertical alignment of the bar and lines becomes extremely

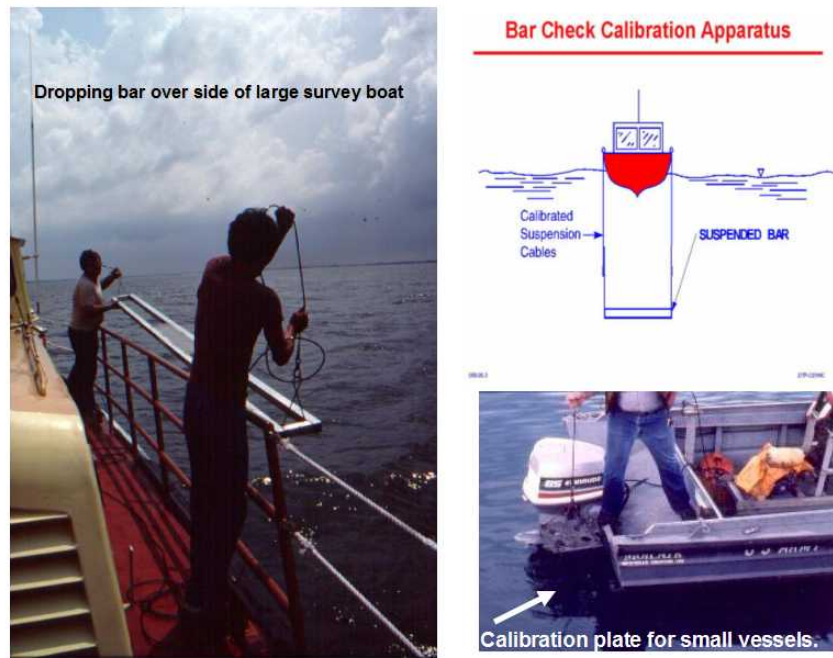

Figure 4-8. Bar check calibration.

difficult, especially at greater bar depths. In such cases, the skill and experience of the boat operator to maneuver the vessel over the suspended bar becomes critical to the process. On smaller vessels, personnel movement during a bar check may affect the nominal (underway) trim of the boat—also known as the "Bubba Effect." Care must be taken to ensure that this variation is minimized.

e. Calibration increments. Static bar comparisons should be taken at 5-ft intervals throughout the project or dredging excavation range. If the recorder is adjusted to display actual bar depths, subsequent bar check readings need to be taken only at the upper, intermediate, and lower project levels to verify stability. A sample bar check observed on an older analog echo sounder is shown in Figure 4-9. The 5-ft incremental bar readings are recorded throughout the dredging range, where in this case, an average velocity of sound in this depth range was obtained.

f. Data corrections. Stage/tidal corrections, vessel squat corrections, draft loading variances, calibration line graduation errors, or any other correction should normally not be “dialed” into the echo-sounder but should be entered as separate corrections in a log or the data acquisition software. Recorded depth data must be “original” relative to the subsequent corrections. Adding depth corrections directly into the depth sounder makes reconstruction of

original survey data difficult -- and indefensible in the case of a contractual dispute or claim over the data adequacy.

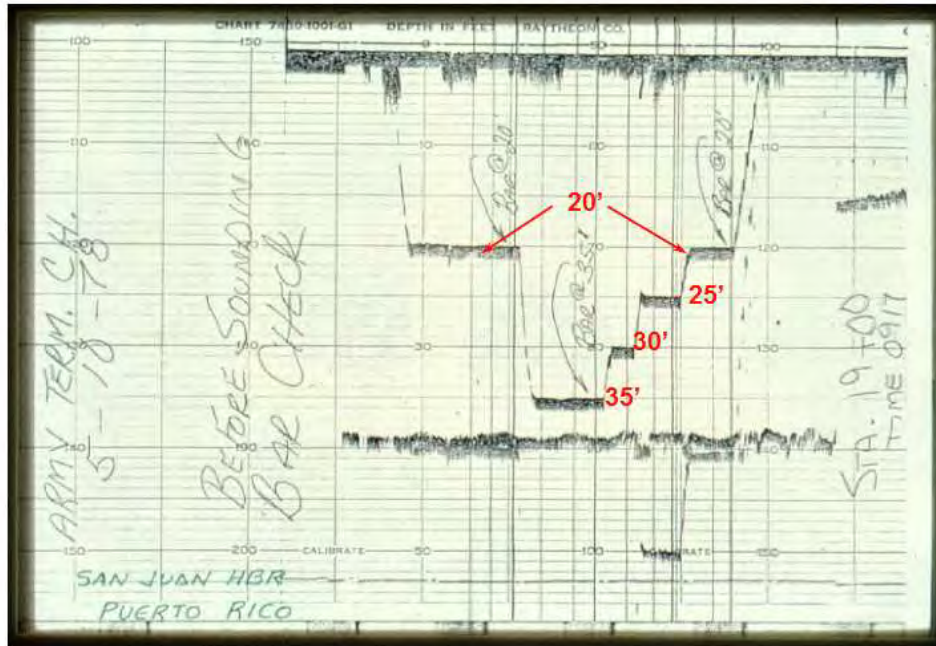

Figure 4-9. Example of bar check in deep-draft navigation project. Bar increments are at 5 ft increments through the dredging excavation limits—20 ft to 35 ft depth. (Jacksonville District)

g. Frequency of bar checks. For critical navigation and dredging support surveys, two bar checks were once recommended each day--one before work and one after completing a day's activity. In a given project or dredging area, the frequency of bar checks may be reduced if repeated bar check indicate a stable draft correction, repeatable average velocity of sound corrections, and repeated agreement with velocity cast data. For example, if repeated velocity casts show the average velocity of sound is 4,905 ft/sec and this agrees with the velocity of sound on the echo sounder obtained by repeated bar checks, then more reliance on velocity cast data would be warranted, and bar checks performed only periodically; weekly or monthly. The "periodic" time span is a judgment call by the surveyor, based on the stability and repeatability being obtained between past velocity casts and bar checks. (These comparisons should be well documented in a log book before bar checks are reduced.) A critical dredging measurement and payment survey (e.g., in a high cost/cy rock cut) may dictate more frequent bar checks during the course of the project. However, if there are ever any concerns over vessel draft changes, only a bar check will be able to measure this.

h. Location of bar checks. Due to the high potential for local temperature and/or salinity variations in typical USACE river and harbor projects, the resultant effect on the velocity of sound must be measured directly at the work site. This is an essential requirement for payment surveys. If an area is known to be subject to extreme temperature/salinity variations, additional

bar checks in these areas may be warranted. In extremely adverse conditions where it is physically impossible to perform a bar check at the project site (due to high winds, currents, and/or sea states), a velocity probe may be used to determine the sound velocity at the project site. However, on critical projects, both a bar check and velocity probe should be simultaneously performed in a protected area near the project vicinity. The sound velocity derived from the bar check should agree within 10 fps with the probe's average velocity in the protected area. The echo sounder draft would be set from the bar check and the echo-sounder "speed of sound" setting would be readjusted based on the probe velocity measured later at the actual project site.

i. Bar check recording. As shown in Figure 4-10 bar check observations may be digitally recorded. Bar check data for digital echo sounders may be optionally recorded in a field survey book or on a survey log form. For dredging payment surveys in which analog backup recordings must be maintained, digital bar check data may be recorded on the analog record for comparative purposes. It is a recommended practice to maintain a continuous record of all bar check calibrations in a bound survey field book aboard the vessel. This record should include draft and speed settings, transmit power and receive gain settings, along with other instrumentation calibration and alignment records, including velocity probe results.

j. Agreement between successive bar checks. If two bar checks are performed each day, they should be compared for excessive differences. Adjustments are never made to the final (end-of-day) bar check. Results are logged at the same check increments used during the initial calibration. Any known draft variation due to loading should be applied to the final readings before comparison. Otherwise, the draft variation may be taken from markings on the vessel hull. Failure to obtain consistent agreement between successive bar check calibrations may be due to any number of physical or electronic causes, and must be located. The frequency of calibration may have to be increased. The mean value of the calibrations may be used to correct the recorded data.

k. Calibration of bar check lines. The bar check suspension lines must be periodically checked to ensure the accuracy and stability of the graduated marks on the lines. Periodic calibration data shall be recorded on a worksheet or in a field survey book. Any errors in the graduated marks must be physically corrected (removed) at the time of calibration.

l. Ross Ball Check calibration. As a substitute to a full-beam bar check, many districts use a center-mounted, spherical calibration ball with a flattened radar reflector type top. This device was designed and developed by Wayne Ross of Ross Laboratories. The ball is suspended on a cable from the interior of the boat by a hand crank-lock mechanism. The line is marked and calibrated in a manner similar to that used for a bar or lead line. An interior water level gage may also be used to measure/monitor the line indexes. Details regarding installation, maintenance and operation of this calibration device can be obtained from the manufacturer (Ross Laboratories, Inc.).

m. Alternate lead line or sounding pole calibration. On shallow draft projects (< 15 ft) with hard sand or rock bottoms, a lead line may be employed to calibrate the echo sounder at or near the project depth level. This "check" does not calibrate the draft or velocity of sound, so it

is only valid around the calibrated depth—say ± 5 ft from that depth. Therefore, do not use this calibration method if depths vary by more than ± 5 ft. This assumes the estimated vessel draft and velocity of sound entries in the depth recorder are relatively close to reality. If so, small

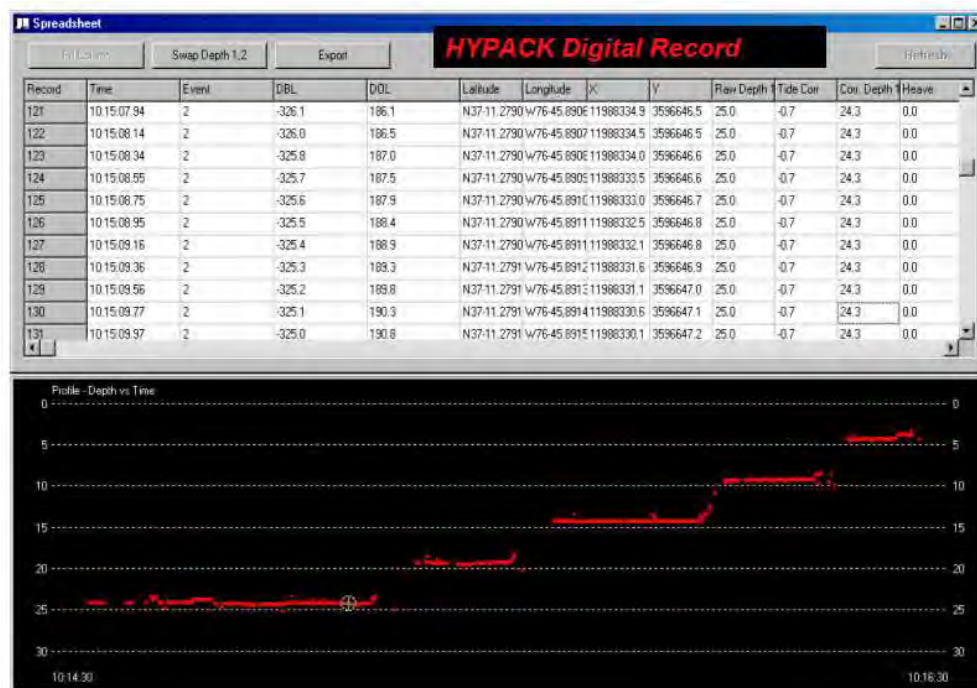

Figure 4-10. Digital record of a bar check.

errors in the draft or velocity of sound will not significantly impact the depth measurements at the calibrated depth. (This method also assumes that the lead line can be placed over the transducer and/or the bottom is flat. If a lock chamber is available, then this is a good place to check calibration.)

4-11. Depth Corrections Based on Bar Check Data. There are several methods of performing bar checks and arriving at corrections to apply to observed depths. (This section assumes no velocity probe data was available and corrections are based strictly on bar check calibration data.) Three methods are commonly used in USACE as outlined described below. Each of these methods is acceptable on any type of survey. Results from a typical bar check calibration are shown in Table 4-1 below. No adjustments to the speed of sound or draft settings were made during this calibration—the bar was dropped at 5-ft intervals and the echo-sounder depth recorded as read. The differences between the bar depth and recorded depth indicate the presence of both a constant index error and a velocity error in the recorded data. The velocity change is exhibited by the increasing differences below 20 ft where a change in the water's sound velocity has occurred. The constant 0.2-ft index error indicates that the presumed 3.0-ft draft measurement must be independently checked. Three different methods for correcting soundings are described below.

Table 4-1. Sample Results from a Bar Check Calibration.

Initial speed set at 5,100 ft/sec		Initial draft = 3.0 ft		Project depth range: 20 to 40 ft	
Depth of Bar	Recorded Depth	Difference	Notes		
5	ft 5.2	ft 0.2	0.2 ft index error indicated		
10	10.2	0.2			
15	15.2	0.2			
20	20.2	0.2			
25	25.3	0.3	Change in water column velocity occurs		
30	30.4	0.4			
40	40.6	0.6			
45	45.7	0.7			
50	50.8	0.8			

a. Correction Table Formula. This is the depth-velocity correction method used by most processing software and many survey organizations. It is the preferred depth correction method. It is the only correction method that will work when the velocity profile is not linear in the water column—i.e., an average “speed of sound” setting on the recorder should not be used. Recorded depths may be directly and individually corrected mathematically without making any adjustments to the draft or speed settings on the recording device. Some survey organizations will put a nominal speed of sound (e.g., 4,800 ft/sec) and assumed draft (0 ft) in the echo sounder and let the software make all the depth-velocity corrections. All recorded depths are adjusted according to the bar check data, such as that recorded in Table 4-1. This reduction can be made on-line when an automated data acquisition system is used or off-line during the post-processing phase. The results of a sample calibration shown in Table 4-1 are used directly for this process; however, a table combining the before and after survey bar checks may also be used. A corrected depth is then computed by:

$$d_c = [[(\text{bar}_i - \text{bar}_{i+1}) \div (\text{rec}_i - \text{rec}_{i+1})] \cdot (d_o - \text{rec}_i)] + \text{bar}_i \quad (\text{Eq 4-2})$$

where:

d_c	=	corrected depth
d_o	=	any observed/recorded depth to be corrected for sound velocity and index
bar_i	=	bar depth at checkpoint i
bar_{i+1}	=	bar depth recorded at point i+1
rec_i	=	recorded depth at bar depth i
rec_{i+1}	=	recorded depth at point i+1
$i, i+1$	=	any two successive calibration depth points and $\text{rec}_i > d_o < \text{rec}_{i+1}$

An observed depth is corrected between its closest range of calibration data. For example, if a 43.5-ft sounding is recorded, it is corrected relative to the calibration data in Table 4-1 at the 40- and 45-ft levels. From the calibration table:

$$\begin{array}{lcl} \text{bar}_i & = & 40 \quad \text{rec}_i = 40.6 \\ \text{bar}_{i+1} & = & 45 \quad \text{rec}_{i+1} = 45.7 \end{array}$$

From Equation 4-2,

$$d_c = \frac{(40 - 45)}{(40.6 - 45.7)} \cdot (43.5 - 40.6) + 40$$

$$d_c = \frac{(-5)}{(-5.1)} \cdot (2.9) + 40$$

$$d_c = 0.9804 (2.9) + 40 = 2.8 + 40 = \underline{42.8}$$

Given a bar check calibration table, all subsequent observed depths may be corrected using the above described procedure. Such a procedure may be performed either on-line or in an off-line mode. Correcting non-digital depth data by this method is obviously not very practical unless that data can be digitized into a database. This Correction Table/Formula method works well in areas of salt wedges or places where the water has distinct temperature differences.

(1) This method may be preferred in the vicinity of power plants where the plant cooling water effluent has a much higher temperature than the surrounding water. This will cause the velocity of sound to increase slightly if the water is turbulent and thoroughly mixed. In most cases the effluent will not thoroughly mix with the surrounding water. This will cause the temperature to be different through the depth layers. The result to the surveyor will be a significant increase in the velocity of sound in these depth layers (shallow soundings). If the bar check table does not reflect this phenomenon, the survey may erroneously indicate extreme shoaling in the area of the power plant outfall. A separate bar check should be recorded in these areas.

(2) Since the velocity of sound is normally fairly stable over most river and harbor projects, it is usually desirable and more practical to base the above-described correction over a wider interval than 5 ft. Given the sample project data in Table 4-1 with excavation depths ranging between 20 and 40 ft, a single correction factor may be computed over that range, since the differences over that 20 to 40-ft range in Table 4-1 are linear.

For example:

$$\begin{array}{lcl} \text{bar}_i & = & 20 \quad \text{rec}_i = 20.2 \\ \text{bar}_{i+1} & = & 40 \quad \text{rec}_{i+1} = 40.6 \end{array}$$

From Equation 4-2,

$$d_c = \frac{(20 - 40)}{(20.2 - 40.6)} \cdot (d_0 - 20.2) + 20$$

$$d_c = 0.9804 d_0 + 0.2$$

The above factor may be used to correct any depth ranging between 20 and 40 ft and may be practically extended to a range of 15 to 45 ft. Such a correction procedure is valid as long as the calibration data are linear over this range.

(3) The constant term (0.2 ft) represents the index correction. The ratio (0.9804) represents a velocity correction between that set in the recorder (5,100 ft/sec) and that actually occurring in the water medium over this range, or approximately $(0.9804) \cdot (5,100 \text{ ft/sec}) = 5,000 \text{ ft/sec}$. Readjusting the recorder to 5,000 ft/sec and modifying the draft line to 2.8 ft (3.0 - 0.2 ft) will not graphically correct the depths over this range.

b. Graphical bar check calibration method (Jacksonville District). The computational method described above may not always be suitable in practice, since the displayed depth cannot readily be related (i.e., on-site) to a required excavation grade. Performing the computations and then applying other required corrections (squat, draft loading variances, and stage/tide corrections), requires automated processing capabilities. Such equipment may not always be available aboard small workboats. Since most construction payment/acceptance work depends on immediate on-site assessment of the recorded data, the computations must be minimized. This may be accomplished by visually/graphically changing the speed of sound and draft settings in the analog/digital echo sounder such that the recorded depth equals that calibrated during the bar check. In essence, the recording mechanism is reoriented and rescaled by appropriate adjustment of the speed of sound and index/draft settings. This procedure is performed only during the initial bar check of the day, never during the final check. This so-called "Jacksonville District" method only works when the sound velocity profile in the water column is linear. If it is not linear, this "trail and error" adjustment method will never "converge." This would be the case in the velocity profile in Table 4-1 where there is an abrupt change at 20 ft. However, if the excavation depths range between 20 ft and 50 ft, then a linear velocity profile can be obtained, disregarding depths shallower than 20 ft. The procedure for making these graphical adjustments on an echo sounder is described below.

(1) Calibration is a sequential process performed by trial and error so that the index/draft and the sound velocity errors are simultaneously minimized. Two depths, for example, 20 and 40 ft, are chosen that correspond to the maximum and minimum project depths. The bar is lowered to the lesser depth, and the depth recorder display is adjusted with the index controls to read that depth value. The bar is then lowered to the greater depth, and the reading is adjusted to that depth using the speed of sound control only. When the bar is returned to the first depth, the reading is observed. If the display reads low or high, the display should be adjusted to the proper reading with the index control. The entire process is then repeated by lowering the bar to the

greater depth, and adjusting the speed of sound control, and then back to the first depth for inspection of the display until the correct reading is produced at all three steps (within ± 0.1 ft). Intermediate readings should then be checked to compare displayed value with the known length of bar lines.

(2) Once set, the speed of sound and draft settings will usually remain fairly stable for a given project area. The primary advantage of the method described above is that a recorded depth can be easily referenced to a required excavation grade. If the velocity of sound is not relatively constant throughout the working depth range, it will not be possible to adjust the instrument so that it reads equal to the bar check at each depth increment. In such cases, the data will have to be corrected by linear interpolation as described previously.

c. Modified graphical bar check calibration method. This method is similar to the above graphical method except that the draft setting on the recorder is not modified. The bar is placed close to the maximum project depth (40 ft in this example), and only the speed of sound control is adjusted so that the observed bar equals the actual bar depth. The bar is then raised at 5-ft intervals throughout the range of project depths, and observed bar readings are recorded. Any significant variation will be corrected in the office data-processing program using the computational procedures described previously. This method only minimizes the error near the lower level at which the sound speed control was adjusted. The recorded values at other depths will be proportionately in error. In the sample data from Table 4-1, at the 20-ft bar check level the recorder will read 19.9 ft, a 0.1-ft error. Near the project excavation grade the instrument is adequately calibrated. However, this is not true up the side slopes.

4-12. Velocity Meter Calibration. A velocity meter (or "Velocity Probe") is a portable, hand-deployed instrument that directly measures sound velocity at intervals of depth in the water column—Figure 4-11. Observed depths are directly corrected based on the velocities obtained from the probe. These corrections are performed in the data acquisition software in real-time. A velocity meter may be used to correct sounding data in lieu of a bar check provided historical comparisons between the velocity probe and the bar check have been performed, and consistent and repeatable results are obtained. Velocity measurements are always taken at the project work site. A velocity meter must still be periodically calibrated, both internally and externally. A periodic bar check is still necessary to calibrate the draft correction.

a. General description of velocity meters. Velocity meters generally consist of a probe attached by cable to a waterproof, hand-held control unit powered by internal batteries. The cable is numerically labeled at 5-m intervals and marked in 1-m intervals, or labeled at 10-ft intervals and marked at 5-ft (or more frequent) intervals. Some models use a pressure sensor for depth determination, thus minimizing cable slant range errors. Velocity meter output is typically velocity of sound as a function of water depth. Sound velocities should be recorded at 1-, 5-, or 10-ft depth intervals, depending on the variability of the velocity readings and project depth. Readings should be made to the nearest 1 foot per second (fps). Where velocity of sound is not constant over the water column (e.g., Table 4-1) a correction table should be developed in the processing software. This is especially critical for multibeam systems where velocity variations

can refract outer beams. Software processing systems provide a sound velocity correction table

based on velocity readings at incremental depths (Figure 4-12). It is essential that velocity meter data be periodically compared to a bar check.



Figure 4-11. Odom DigiBar Pro Velocity Profiler.

b. General description. An Odom DIGIBAR-PRO is a velocity meter used in many USACE districts. It employs a sing-around method of sound velocity determination. Mounted near the end of the sampling probe is a high frequency "sing-around" transducer and its associated reflector. This precisely spaced pair is used to measure the velocity of sound in water by transmitting and receiving a signal across their known separation distance. After the first transmission, the received echo is gated and introduced into the feedback loop of an oscillator that re-triggers the transmitter and begins the cycle again. The frequency resulting from this regenerative feedback loop is determined by the distance the signal travels (transducer to reflector and back) and is directly proportional to the velocity of propagation of the sound pulse through the measured medium. This method of direct sampling means that all factors that influence the velocity of sound, including salinity, pressure, and temperature, are taken into account. The average velocity value of each cast can be calculated, or the entire velocity profile of the cast can be up-loaded to a computer, in spreadsheet format, for subsequent use in depth or ray-bending calculations. The unit not only samples, displays, and stores values for the velocity of sound in water, but it also ties each collected value to a precise depth. The meter has a pressure sensor to determine depth of the probe.

c. Velocity probe quality control test. The operation of the velocity probe should be periodically calibrated. The frequency of these tests may vary depending on the manufacturer's

EM 1110-2-1003

30 Nov 13

recommendation. The following equipment is typically needed for data quality assurance tests of velocity probes:

- (1) Calibrated thermometer
- (2) Clean fresh water
- (3) Clean vessel (plastic bucket) large enough for the probe.

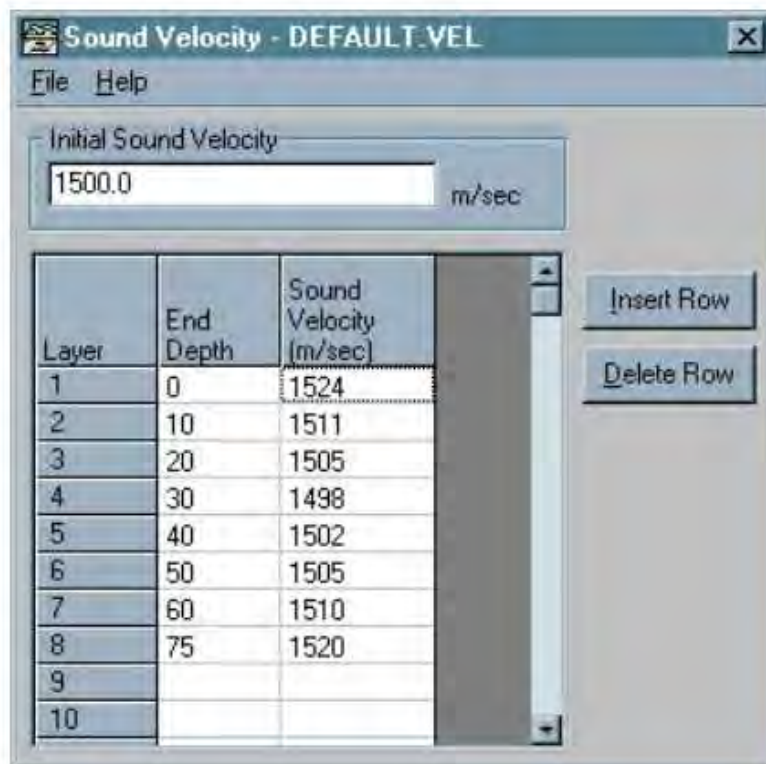

Layer	End Depth	Sound Velocity (m/sec)
1	0	1524
2	10	1511
3	20	1505
4	30	1498
5	40	1502
6	50	1505
7	60	1510
8	75	1520
9		
10		

Figure 4-12. Sound velocity correction table entered into a data collection system (HYPACK).

Fresh water is needed because its salinity (parts per thousand) is less than that of seawater. In some cases the fresh water salts, pollutants, or other particles in suspension may affect the water density. Distilled water should be used if this is the case. Using the manufacturer's calibration chart, the propagation velocity can be computed with known temperatures.

d. Velocity meter corrections/calibrations. The velocity probe measures the actual sound velocity over the entire depth measurement range. From these data, a correction algorithm can be devised for on-line or post-processing data reduction. If velocity probe data are used to obtain an average sound velocity over a given range, then this average velocity may be used to adjust the digital or analog recording echo-sounder as is done with a bar check calibration. The average velocity determined from a velocity cast should be within 10 ft/sec from the indirect average velocity determined by a bar check. A velocity probe calibration does not confirm/check the index/draft setting on the analog/digital recorder. This must be done with a bar check.

e. Velocity probe v. Bar check. A major advantage of a velocity probe check over a bar check is the ability to perform rapid calibrations in heavy seas or currents. Calibrations are thus more easily (and frequently) performed directly at the project site. If repeated comparisons between the velocity probe and bar check yield consistent velocity measurements, then the velocity probe can be used with confidence.

f. Velocity computation from measured water samples. If the velocity of sound is required in an area beyond the reach of a tethered velocity probe (such as in a deep offshore disposal site), then alternative methods are needed to measure the velocity. If water samples are obtained at the lower depths, then the velocity of sound at that depth can be computed from the following formula:

$$V = 1448.96 + 4.591 T - 5.304 \times 10^{-2} T^2 + 2.374 \times 10^{-4} T^3 + 1.340 (S-35) + 1.630 \times 10^{-2} D + 1.675 \times 10^{-7} D^2 - 1.025 \times 10^{-2} T (S - 35) - 7.139 \times 10^{-13} T \times D^3 \text{ (meters/sec)} \quad (\text{Eq 4-3})$$

where,

T = temperature in degrees Celsius

S = salinity in parts per thousand (ppt)

D = depth in meters

In practice, a CTD (Conductivity-Temperature-Depth) instrument is deployed through the water column, from which the above parameters can be computed.

4-13. Squat and Settlement Calibration. As a vessel's speed increases, it generally settles (draft change) or squats (pitch change) into a lower profile in the water or planes into a higher profile, causing an error in depth measurement that must be corrected. This combined vessel draft and pitch motion correction is field calibrated and typically entered into the data collection system as a "Squat Correction Table." A "Squat Test," calibrating underway combined squat and settlement, should be performed at least annually to determine the relation between boat speed and transducer height above or below the static sounding reference plane. Report results of this calibration test in a field book. Squat correction tables/curves should be maintained aboard the vessel--see example in Table 4-2. RTK systems which provide direct (absolute) antenna-water surface-transducer elevations eliminate the need for the squat correction, as the RTK ellipsoidal antenna height will record the vessel trim variations in real-time.

a. Conventional differential leveling techniques are used to measure the required calibration constants under normal loading (fuel/personnel) conditions. A level is set up on a pier or bulkhead with the boat in a static position in calm water, and elevations are taken at a point on the boat directly over the transducer, i.e., amidships. With a stadia board or level rod

EM 1110-2-1003

30 Nov 13

held at this point, the boat is driven past the instrument at various speeds, and elevation differences are noted at each speed. In moving bodies of water (wind and/or current), this procedure must be run both up and down current to obtain the mean speed/squat. Boat speeds

(actually RPMs) and observed rod readings are recorded on the form. A subtraction of rod readings after due correction for tide differences gives the squat corrections at each speed.

Table 4-2. Squat and Settlement Calibration (65-ft Surveyboat Florida, Jacksonville District).

Conducted 29 May 1998, St. Johns River, Jacksonville, FL

Engine RPM	Upstream Rod	Downstream Rod	Tide	Squat	HYPACK Entry
Dead in water	0.70	--	1.12	0.00	
800	0.73	0.73	1.19	-0.10	+ 0.10
1000	0.65	0.63	1.33	-0.15	+ 0.15
1200	0.62	0.58	1.43	-0.21	+ 0.21
1500	0.58	0.58	1.50	-0.26	+ 0.26
1800	0.43	0.41	1.60	-0.20	+ 0.20

b. General solution for determining vessel settlement and squat on each pass (Differential Leveling Method).

$$\text{Settlement and Squat Correction} = (T1 - T0) + (R1 - R0) \quad (\text{Eq 4-4})$$

where

T0 = tide reading dead in water

R0 = rod reading dead in water

T1 = tide reading at underway RPM

R1 = rod reading at underway RPM

(If RTK observations are used instead of differential leveling, simply insert the RTK "R0" and "R1" elevation readings in the above formula.)

c. Squat/Settlement measurement using RTK. An alternate method for determining squat/settlement makes use of carrier-phase GPS elevation difference measurements.

(1) Position the RTK antenna near the center of the vessel and measure the vertical and horizontal distance from the antenna to the vessel's reference point with steel tape.

(2) Use data from a nearby tide gage to provide a datum from which to measure the elevation. The gage should be in the survey area and if the area is large, two gages should be used.

(3) Run the same survey line at different speeds. Also, run the line under different loading conditions.

(4) Record the RTK elevations, heave, pitch, roll, vessel speed, and water levels at common times. The sampling rate should be at the highest for RTK and MRU (IMU) sensors (10 Hz and 100 Hz, respectively) while the water levels can be recorded at approximately 5- to 10-minute intervals.

(5) Record the antenna height while stationary.

(6) All data should be synchronized and interpolated if necessary.

(7) Use the RTK antenna offsets and attitude data to compute the roll and heave, and correct the antenna elevations. Subtract water level data and heave data from GPS antenna elevation.

(8) With these corrections for motion and water levels, compute the average speed in the water and the average antenna elevation with respect to the ellipsoid. Produce a look up table for the transducer draft correction.

d. Corrections are added to the soundings to refer them to a static state. Squat corrections are therefore considered positive quantities as the transducer depresses (squats) deeper into the water at increased speeds. In this case, a positive squat is added to the raw observed/recorded depth. A negative squat may occur with high-speed planeing, surface effect, or hovering type vessels. For these types of survey vessels, a squat test is especially critical and must be performed more frequently.

4-14. Vessel Dynamic Draft Calibrations. Boat loading variances during the course of a survey will affect transducer height. Short-term variations in the draft due to fuel usage may be observed directly from scribe marks on the hull abeam of the transducer. Any such variation should be evidenced directly in subsequent bar checks. The actual draft/index setting on the recorder/digitizer may optionally be changed to reflect a draft variation; however this practice is not recommended. These dynamic draft variations should be entered as separate depth corrector in the real-time software. Data from bar check draft calibration observations should be compared with the water line mark readings to establish a record of draft variations, from which corrections may be directly applied to recorded depths based solely on hull waterline-mark elevations.

4-15. Latency Calibrations. Latency is the time difference or lag between the time positioning data are received and the time the computed/processed position reaches the data logging module

EM 1110-2-1003

30 Nov 13

and is time-tagged. Latency typically results in a negative along-track displacement of the depth measurements--i.e., the time-tagged observed depth is acquired during the positioning system reading cycle whereas the output position is time-tagged when the computation cycle has been completed. While surveying at slow speeds, this displacement will be small. At higher speeds,

the displacement increases--i.e., it is proportionate to the speed. Position-depth latency distances of up to 40 ft have been observed--an intolerable systematic error that must be corrected and periodically calibrated. The impact of a latency error is illustrated in Figure 4-13 where a saw tooth contour results at each cross-section. Latency displacements are also a function of the type of positioning system used. For code DGPS systems, the processing time for the position will vary with the number of observations used in the final GPS solution--thus causing small variations in the latency itself. Use of the "T0" pulse from the GPS receiver minimizes this error. If the time imbedded in the GPS message is used, then the correct synchronization between this time and the transducer or signal processing clock must be assured. The latency delay is computed by measuring the along-track displacement of soundings from the pair of coincident lines run at different speeds over a steep slope or other prominent topographic feature. Details on performing latency time bias tests are found in the multibeam systems chapter of this manual. Procedures for internal time-tagging GPS messages and applying latency corrections (in real-time and/or post-processing corrections) are contained in the HYPACK Software User Manual (HYPACK 2011)--typically under hardware setup sections where various positioning equipment offsets are entered. Latency bias calibration tests and synchronization of time-tagging correctors are absolutely critical and must be periodically performed and monitored.

SECTION IV

Data Collection, Editing, and Processing

4-16. Single Beam Survey Methods. Single beam surveys are run either normal to (i.e., cross-sectioned) or parallel with the channel or river alignment. Cross-sections for dredge payment surveys are usually spaced between 50 and 200 ft, depending on the bottom consistency between sections and need for shoal or strike detection. Cross-sections are extended up the channel sides to ensure the dredging template is fully covered for payment. Cross-section spacing for general Project Condition surveys is typically 100 ft c/c; however, 200 ft to 500 ft spacing is performed on some projects where less density is required. Project Condition Survey lines are sometimes run parallel with the channel or river alignment—usually inside the channel toes. The spacing of parallel lines is typically between 50 and 250 ft, again depending on channel/river dimensions and shoaling patterns.

4-17. Depth Collection Density and Bottom Coverage. Single beam echo sounders typically collect depth data at a rate of 1 to 20 soundings per second, usually depending on depth. Data acquisition systems can be set to acquire some or all of these data points each second. If continuous bottom coverage along the cross-section is required, then the update rate should be adjusted such that each portion of the cross-section is ensonified. This update rate is a function of the average or project depth, vessel speed, and transducer beam width. An approximate computation of this update rate can be made from the following equation:

$$\text{Update rate (milliseconds)} = 1185 \cdot (D / v) \cdot \tan(a/2) \quad (\text{Eq 4-5})$$

where

D = Average or project depth

v = Speed in knots and a = Transducer beam width

a. Since all these parameters can vary during a survey, the minimum practical update rate should be used. For example, given a project depth of 43 ft and an 8-deg transducer, the required update rate would be 400 milliseecs at 5 kts, and 200 milliseecs at 10 kts. Thus, a 200 millisecc rate (i.e., 5 depths/sec) would be adequate for all speeds less than 10 kts. However, if the project



Figure 4-13. Effect of latency error in data contours as shown in plan view of channel.

depth were only 20 ft, a 100 millisecc collection rate would be needed to obtain full along section coverage if the vessel runs up to 10 kts. In general, a 100 millisecc update will be adequate for most surveys. Setting too large an update rate could leave data gaps. Higher densities (i.e., every 50 to 100 milliseconds) might be collected in rock-cut channels to give a more accurate representation of the bottom and to detect strikes above grade. A high density of depths may also be needed to confirm multiple hits on strikes. Data collection software allows input of the desired depth collection rate. As high-density depth data is recorded, it is time tagged to interpolated positions taken at a lower update rate. Dredging contracts should specify depth data collection density used in payment computations, and distinguish the process by which depths are thinned or generalized for plotting purposes (i.e., sorting, binning, or gridding techniques).

b. Ensonification coverage on bottom. Each transducer ping ensonifies an area of the bottom. The size of this ensonified area is a function of the transducer beam width and transducer characteristics (i.e., side lobes). The narrow beam transducers used in the Corps

ensonify a smaller area of the bottom; resulting in less distortion or smoothing of bottom features within this area. However, only a small portion of a channel is ensonified by narrow beam transducers. Table 4-3 illustrates the lineal coverage for typical USACE transducers. Table 4-4 depicts the resultant footprint coverages.

Table 4-3. Approximate Lineal Coverage for Different Beam Width Transducers.

Project depth	<u>BEAM WIDTH</u>			
	1.5 deg	3 deg	8 deg	20 deg
10 ft	0.3 ft	0.5 ft	1.4 ft	3.5 ft
25 ft	0.7 ft	1.3 ft	3.5 ft	9 ft
50 ft	1.3 ft	2.6 ft	7 ft	18 ft
75 ft	2 ft	4 ft	10 ft	26 ft

Table 4-4. Approximate Footprint Coverage for Different Beam Width Transducers.

Project depth	<u>BEAM WIDTH</u>			
	1.5 deg	3 deg	8 deg	20 deg
10 ft	< 1 sq ft	< 1 sq ft	< 2 sq ft	10 sq ft
25 ft	< 1 sq ft	< 2 sq ft	10 sq ft	60 sq ft
50 ft	< 2 sq ft	5 sq ft	40 sq ft	250 sq ft
75 ft	3 sq ft	10 sq ft	90 sq ft	550 sq ft

(1) Table 4-4 clearly indicates that bottom coverage is small for narrow beam transducers. Thus, when cross-section surveys are performed, only a very small portion of the channel is ensonified. The total amount of ensonified coverage for typical cross-section surveys at 100-ft and 200-ft spacings is shown in Table 4-5.

(2) Table 4-5 indicates that only 1% to 5% of a channel bottom is typically ensonified by single beam cross-section surveys. From this small data sample, shoaling conditions are projected and material quantities are estimated using end area projection methods. In effect, quantity take-off computations and shoaling estimates are "extrapolated" over 95-99% on the

channel that is not surveyed. These estimates have traditionally been adequate for engineering and construction purposes, and they were deemed practical given the high cost of data collection per cross-section.

Table 4-5. Approximate Percent Bottom Coverage for Cross-Section Surveys.

Project depth	<u>100-ft Cross-Sections</u>			<u>200-ft Cross-sections</u>		
	1.5 deg	3 deg	8 deg	1.5 deg	3 deg	8 deg
10 ft	0.3%	0.5%	1.4%	0.1%	0.2%	0.7%
25 ft	0.7%	1.3%	3.5%	0.3%	0.6%	2%
50 ft	1.3%	2.6%	7%	0.6%	1%	4%
75 ft	2%	4%	10%	1%	2%	5%

4-18. Field Collection of Single Beam Survey Data. Most USACE districts collect and process single beam data using commercial hydrographic survey software platforms, the most common being the HYPACK software platform which is currently used by nearly all districts. A brief description of the current (2013) process in HYPACK is outlined below. (Note that these field collection methods and software modules will evolve over time; thus, the following should be considered current guidance only.)

a. Establishing survey line files. Prior to surveying, the desired cross-section coverage is set into the survey acquisition system. Data acquisition packages have a variety of features to set up survey lines relative to a project or channel alignment. These are found in the "LINE EDITOR" and "CHANNEL DESIGN" programs. Either straight or curved survey lines can be generated. Survey lines can be set up to cover turning basins--see example at Figure 4-14. Included with the cross-section alignments are the channel turning point coordinates along with side slope grades. This line file data may also be used for subsequent end-area volume computations.

b. Irregular channel cross-sections. Line Files can also be configured to optimize spacing of cross-sections through varying channel baseline alignments (Figure 4-15). This so-called "SMART CORNERS" option can be used to improve average-end-area volume computations in these irregular areas; however, in this example, a TIN model might be an easier method of computing dredge quantities.

c. Field data collection. The "SURVEY" program collects continuous data from the various depth, motion, and positioning sensors. Parameters for all these sensors are set up in the "SURVEY" program, along with applicable depth corrections (e.g., tide, draft, squat, etc.). The real-time software provides windows for the system operator and boat helmsman, such as left-

EM 1110-2-1003

30 Nov 13

right guidance, planned survey line maps, motion sensor status, position and depth alarms, etc., as illustrated in Figure 4-16.

d. Marking position events on hard-copy depth profile records. Real-time horizontal positioning event marks (or fixes) are typically made on analog or digital hard-copy recorders. The vertical event line in the recorded profile may be manually “fixed” or automatically

generated from the positioning system. Event marks are usually tied to the channel station-offset coordinate system.

4-19. Editing and Processing Single Beam Data. The HYPACK "Single Beam Editor" processing software flow is shown in Figure 4-17. The “raw” observed depth data was time-tagged during the survey collection, as were inputs from other peripheral devices (GPS, IMU, tide, etc.). Single beam depth sounders are capable of recording depths at rates of 10 or more per

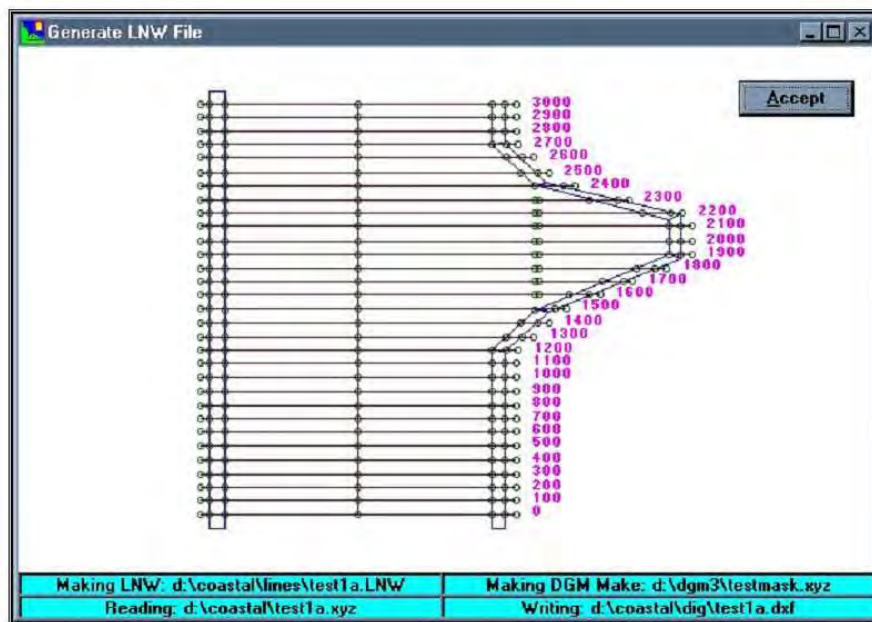

Figure 4-14. Planned survey lines covering channel and adjacent turning basin including channel limits and side slope parameters.

second; however, GPS positional updates are typically input every second. Thus, the processing software must interpolate and time-tag positions for the intermediate depths. Likewise, any observed roll, pitch, heave, and heading sensor data comes in at varying times and must be time-tagged to each depth. Based on the time of the depth measurement, the Single Beam Editor correlates the position, tide, stage, vessel draft, sound velocity, and motion corrections. Manual (visual) editing may be performed on each cross-section, verifying depth corrections and removing outliers or anomalies. Automated filtering options may also be applied. Each “edited”

depth is then saved with all corrections made to the original observed (raw) depth. A variety of depth sorting and selection options are available depending on the intended final product—plan or section plots, volumes, channel condition report controlling depths, modeling, TINs, etc. (See the HYPACK User's Manual (HYPACK 2011) for complete details on the editing and processing options available in the "Single Beam Editor.")

4-20. Depth Selection and Thinning Options on Single Beam Data. Single beam depths recorded along a cross-section are too dense to plot on plan documents (maps and charts). The

dense soundings are thinned (i.e., “sorted”) to conform to the desired final plan plot scale, e.g., between 4 and 8 soundings per inch at the scale of development. Higher densities (or all recorded depth data) may be plotted in profile section views, or plotted as color coded pixels in plan view. The sorting options shown in Figure 4-17 provide various options for thinning depths along a cross-section and removing overplots.

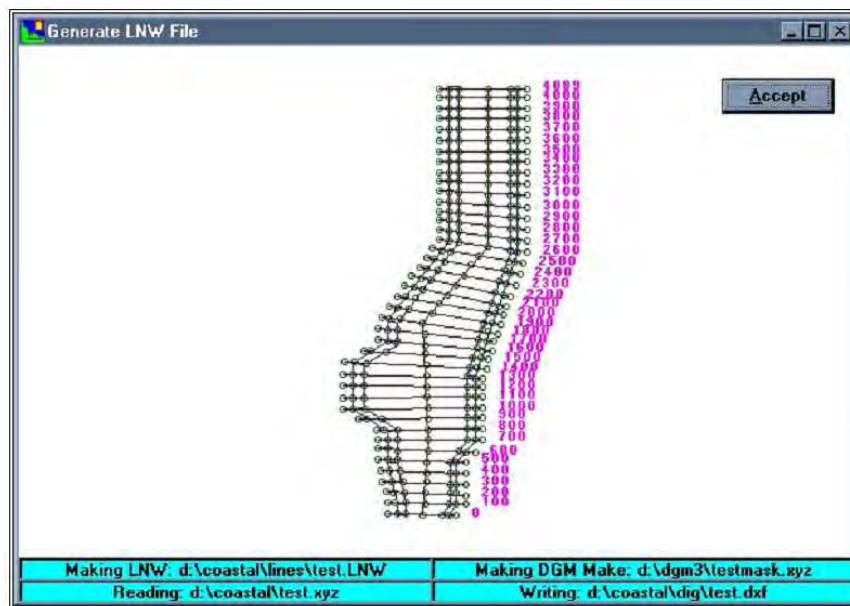

Figure 14-15. "Smart Corners" generated planned survey lines covering irregular channel alignments--cross-section alignment varies over channel intersections.

a. Representative depth selection. The selection of a representative output depth (e.g., shot, minimum, strikes, confirmed hits, etc.) is dependent on the survey purpose and/or intended plan scale—see details in Chapter 2. Observed (“shot”) depths are often just randomly selected (sorted) to fit the available plot region along a cross-section—e.g., “select the next depth in the cross-section file that won’t overplot the previous depth.” Minimum depths over a cross-section or channel region may also be sorted out for controlling depth reports—see Chapter 8.

EM 1110-2-1003

30 Nov 13

b. Dredge volume computations. All the recorded and edited observed depths along a cross-section should be retained for volume computations. These depth values may be plotted at points on a section view of each cross-section. Shot depths shown on plans and specifications surveys, and on pre- and post-dredge plans, should be randomly sorted as outlined above. Drawing notes should clearly indicate that quantity estimates were based on the total datafile, not the sorted (thinned) plotted version.

SECTION V

Single Beam System Quality Assurance Performance Tests

4-21. Depth Quality Assurance Techniques for Single Beam Surveys. This section describes various procedures used to test quality assurance (QA) on a single beam hydrographic survey. These techniques are especially applicable to critical navigation and dredging payment surveys. The primary (and most critical) reason for conducting QA Performance Tests is to detect a systematic bias (or lack of repeatability) in the data--e.g., tide, velocity, squat, etc. Single beam Performance Tests generally rely on comparisons of depth measurements observed from two surveys of the same area by the same survey vessel. Where possible, comparisons should be made against different vessels over an established test site. The adequacy of these comparisons depends on the number of depth comparisons made and the independence of the comparative surveys; in many instances, the number of comparison points may not be statistically valid and

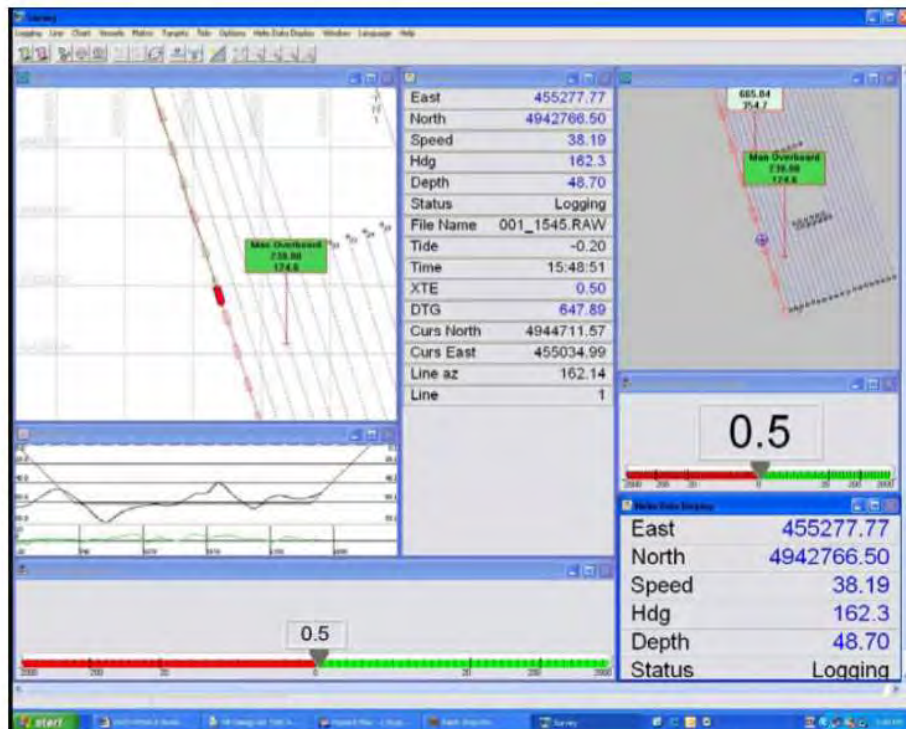

Figure 4-16. "SURVEY" program for single beam data collection—sample real time system operator and helmsman display options.

the surveys are not truly independent if comparing data collected by the same vessel. From a rigid statistical sense, the results of non-independent comparisons (same survey vessel and echo sounder) are only an estimate of the internal precision, not “accuracy” or "TPU." Therefore, comparative data derived from non-independent tests cannot be considered as an absolute quality check.

a. Cross-line check method. On typical channel cross-section surveys, a number of parallel lines (3 to 5) are run along and within the channel, to intersect with the cross-sections. Comparisons are made of depth differences at the intersecting points between the cross-sections and the parallel lines. Preferably, these check lines are run at different tide/stage levels and after recalibration of depth sounding equipment. Depth differences at the intersecting points are tabulated and statistically analyzed. The mean difference and standard deviations of crossing elevations should generally fall within acceptable tolerances for the type of survey (Chapter 3). At least 100 cross check comparisons should be obtained, and preferably many more. The mean difference or bias between the two separate surveys is the more critical test than the standard

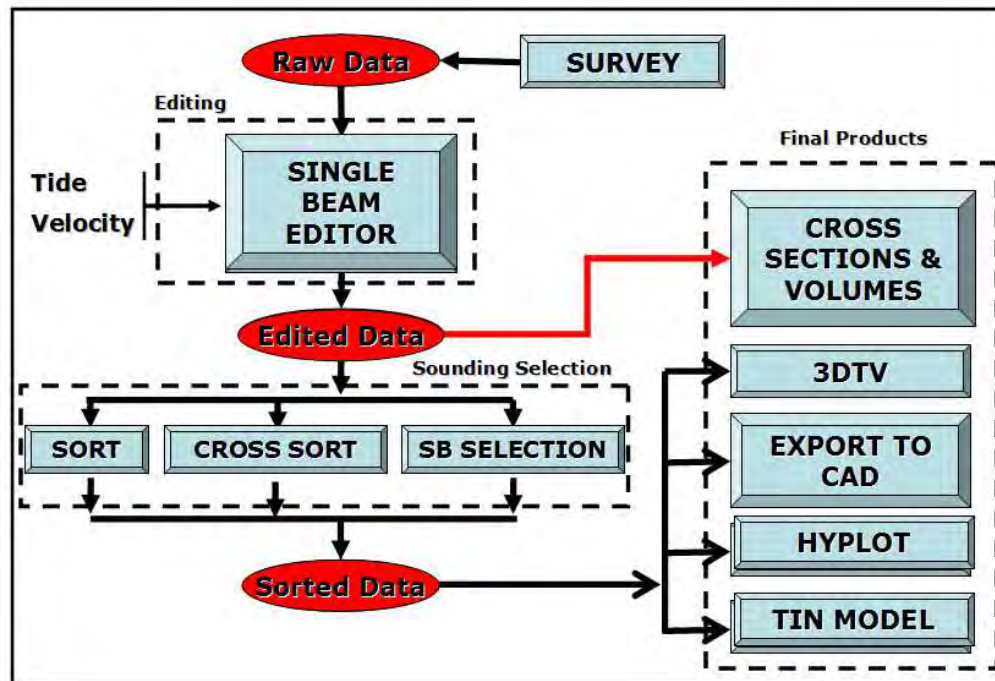

Figure 4-17. Single beam editor data processing flow. Depth sorting options are dependent on final use of the data (plots, volumes, TIN, etc. (HYPACK 2011)

deviation result. The results of such a cross-line check analysis should be noted on all plots, drawings, metadata files, maps, or charts; as an indication of the data consistency (actually

repeatability) obtained. As such, when performed by the same vessel, this cross-line check method is not an independent test. Software can perform the cross-line check comparisons, tabulate the differences, and the statistics of the results. Examples of cross-line test examples are shown in Figure 4-18 and Figure 4-19.

b. External check line comparisons. Another single-beam quality assurance technique involves the establishment of external check lines. This QA test was developed by the Norfolk District to test for tidal modeling variations in offshore regions in Chesapeake Bay. Check lines are established parallel with the channel and outside of it far enough that any activity in the

channel will not affect the natural lay of the bottom covered by the check line. The check line location is selected in an area that is relatively devoid of any abrupt changes in elevation. Depending on the length of the survey there may be several lines, i.e. one in each tidal zone. These same lines are run each time the project is surveyed. Mean differences are computed—primarily to check for biases due to tidal variations. Since past surveys and different vessels are used, this method does provide an independent check.

c. Averages of Extended Cross Sections. Extended cross sections into undisturbed areas well outside the channel is another single-beam quality assurance technique that provides an independent check on the survey adequacy. These extended sections provide a means for comparing successive surveys of a given cross-section. As with external check lines, these extended cross-sections will provide an indicator of biases between different surveys. Resolving the source of any recorded biases is the difficult part of the process.

(1) The use of extended cross sections for comparing successive surveys requires that four conditions be satisfied. First, the number of extended cross sections needs to adequately represent the survey area. Second, each cross section must be extended beyond the area affected by dredging, since the comparisons could be made between surveys conducted before and after dredging. Third, the bottom outside of the dredging area must be relatively flat; otherwise it will be difficult to distinguish between the natural bottom and a survey discrepancy. Finally, the bottom must be relatively stable outside of the dredging area.

(2) The primary purpose of extended cross sections is to compare two given surveys by computing the average depth along the extended portion of each cross section. This is repeated for each successive survey of a given cross section. The algebraic difference between the average depth of each of the two surveys is computed. Then the average algebraic difference of all the cross sections is computed. The result of this analysis will be a measure of how well two given surveys at a given cross section repeat each other and how well the two surveys of the entire group of cross sections compare overall.

e. Cross-section overlay comparisons: Real time or Post-Processed. During dredging operations it is advantageous to compare a current survey with previous surveys of the same area/cross-section. This can serve as a "blunder check" when performed real-time aboard the survey boat. An example of such a comparison is shown at Figure 4-20.

SECTION VI

Summary of Quality Control and Quality Assurance Criteria for Single Beam Surveys

The following table summarizes recommended QC and QA criteria for USACE single-beam surveys. These criteria are critical for surveys supporting dredging and navigation.

Table 4-6. Recommended QC and QA Procedures for Single Beam Surveys

Procedure	Recommended Application
Bar Check Calibration	Perform periodically. Frequency of bar checks can be reduced if average velocity repeatedly correlates with velocity cast data. Perform at beginning of critical dredging projects. Correlate with dynamic draft variations.
Dynamic Draft Corrections	Monitor every 0.1 ft trim change.
Velocity Cast Calibration	Perform, at minimum, twice daily. More often in highly variable waters. Correlate with bar check velocity.
Squat/Settlement Calibration	Perform annually over different vessel speeds and loading conditions.
Latency Calibration	Perform periodically to obtain average correction over time. Perform at beginning of any critical dredging survey.
Horizontal Position Check	Daily on dredging projects (RTK v Code DGPS adequate)
Vertical Calibration (RTK)	Perform twice daily at project reference gage or tidal bench mark.
Motion Compensation	Apply if river or sea conditions warrant correction.
Vertical Datum Verification	Refer to EM 1110-2-6056 for periodic requirements to ensure coastal tidal datums are consistent with NOAA reference datums; including periodic checks of tide/staff gages.
Survey Coverage (Density)	On maintenance projects, single beam cross-sections should generally not exceed 200 ft c/c. (Full multibeam survey coverage is recommended for deep-draft projects with critical under keel clearances over rock.)
Quality Assurance	

EM 1110-2-1003

30 Nov 13

Performance Tests

Perform periodically against other vessels at constant test site. Perform internal repeatability check daily on critical dredging surveys.

The following matrix is an example of a "Single-Beam Standard Operating Procedure" developed and used by Buffalo District for a specific type of depth recorder. This "best practice" example illustrates the typical quality control and quality assurance checks performed during a field survey.

Table 4-7. Single-Beam Survey Standard Operating Procedure (Buffalo District).

Equipment Set-up:

Attach depth sounding unit to the 12-volt batteries via power cable.

Attach power cable to differential GPS unit.

Attach GPS antenna to differential GPS unit.

Attach VGA cable (boat operator driving screen) to depth sounding unit (via cable).

Attach transducer cable to depth sounding unit.

Equipment Calibration:

Turn on depth sounding device (not transducer).

Open Depth computer program. Create new folder and link Depth data so the .BIN and .TXT files are saved to said folder.

Turn transducer on.

Download .BIN data to external drive.

Drop check bar to required depth (depending on survey data needs).

Within computer program, adjust speed of sound to the project depth.

Minimize computer program and open HYPACK to begin to survey.

Survey Data Collection:

Obtain a gage reading.

Open HYPACK and create new project.

Enter project information.

Check geodetic parameters for area.

Activate appropriate line file for work area and navigate to area.

Run a latency line within HYPACK.

Use log sheets to document the Time, Gage, Speed of Sound, and Notes for each line that's run. Document the Cross Section (e.g., 100+00), line file #, Direction, Speed, Line Good vs. No Good, Pertinent Data, etc.

Obtain a gage reading depending on crew availability, weather conditions, and USACE engineering manual regulations. A minimum of 2 gages is required (before and after survey) if limited to 2 man crew in a small harbor and weather is calm.

Obtain a horizontal position check.

Equipment Breakdown:

Download .RAW data files to external data device.

Download .BIN data from the SDI folder. If desired, rename appropriate .BIN file with the cross section included with the associated file.

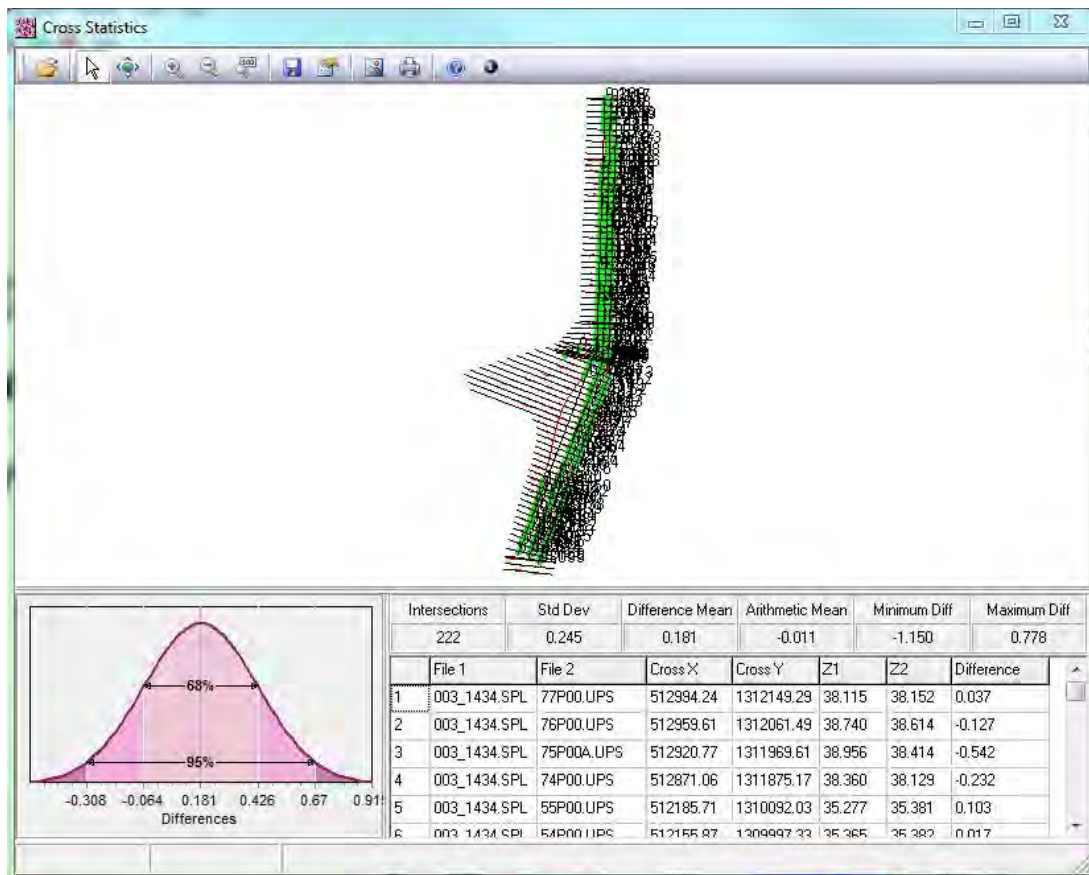

Figure 4-18. Automated cross line check software. Statistics output from 222 intersections are standard deviation (± 0.245 ft one-sigma), mean difference ($+0.181$ ft), absolute difference (-0.011 ft), and minimum/maximum differences (-1.15 ft and $+0.77$ ft). The 95% standard deviation from the test is ± 0.5 ft. (Ybor Channel, Tampa Bay, Jacksonville District)

Kings Bay Navy Base Entrance Channel (Cut 1N) Cross-Line Comparisons							
Surveyboat Florida, Jacksonville District							
1-2 August 2000							
RTK GPS positioning and elevation. Heave compensation active.							
Search radius set at 10-ft							
Single beam cross line check differences in feet							
<hr/>							
+1.16	-0.72	-0.19	-1.47	-0.41	-0.07	-0.71	+0.43
-0.14	+0.86	-1.52	-0.50	-0.41	-0.61	+0.98	+1.71
-0.89	-0.29	+0.60	-1.95	+1.26	+0.02	-0.05	-0.26
+2.04	-0.24	-1.17	-0.79	+0.19	+0.88	+0.99	+0.38
+0.55	-0.16	-0.28	-0.89	-4.05	-0.46	-0.45	+0.56
+0.82	-0.69	+0.36	-0.43	-0.67	-0.35	-1.6	+0.17
-0.53	-0.24	+0.45	-0.12	-0.86	+1.77	+0.45	-1.65
+1.95	-0.04	+0.57	+0.00	+0.61	+0.91	+0.88	-0.80
+0.33	+0.09	+1.15	-0.08	+0.03	+0.38	-0.14	
+1.08	-0.06	+0.17	-1.18	+0.10	-0.07	-0.05	
<hr/>							
Total number of cross-check observations = 78							
Mean of Differences				= (-) 0.043 ft			
Confidence of computed mean (95%)				= ± 0.21 ft			
Standard Deviation (67%)				= ± 0.944 ft			
95% Estimated Accuracy				= ± 1.85 ft			

Figure 4-19. Single beam Cross Check Line Performance Test.
(Jacksonville District)

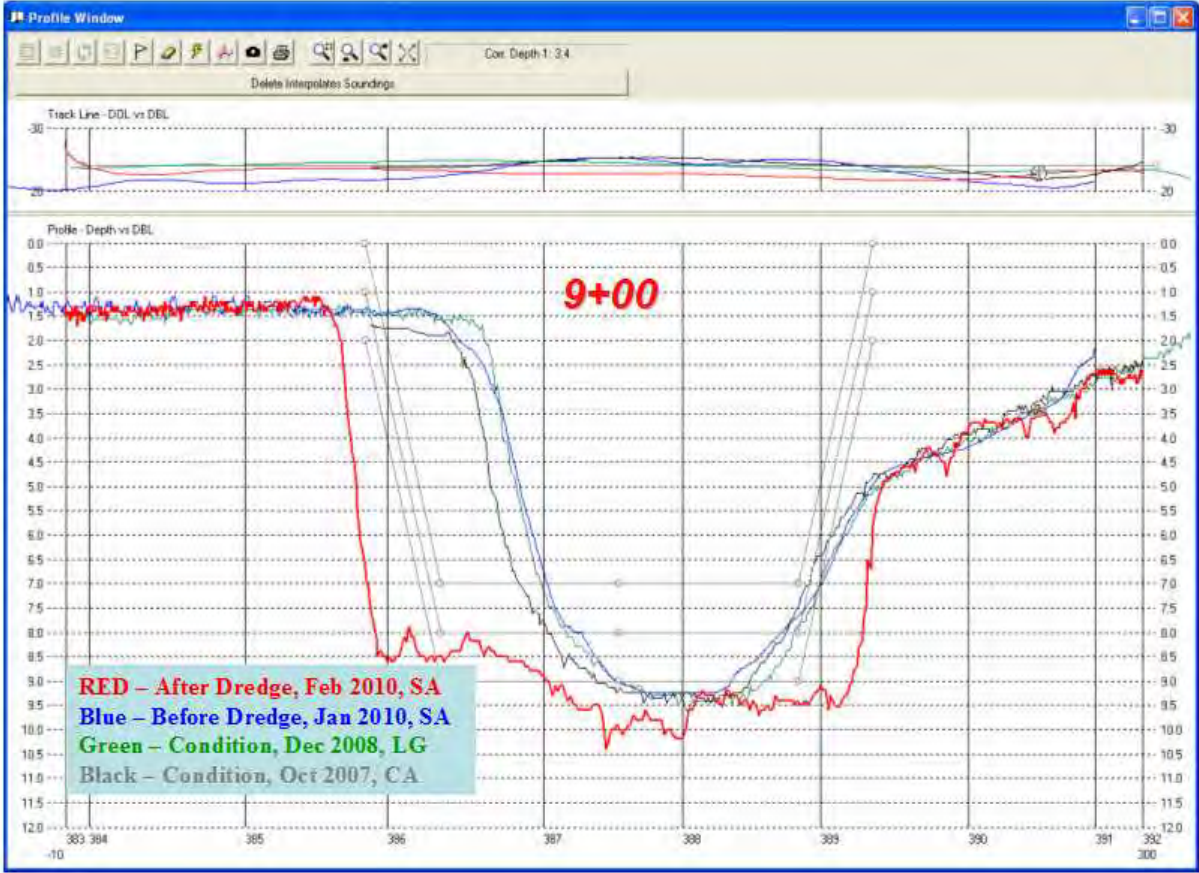

Figure 4-20. Post-Processed comparisons of four successive surveys at Station 9+00, Broad Creek Channel. (Norfolk District)

EM 1110-2-1003
30 Nov 13

THIS PAGE INTENTIONALLY LEFT BLANK

CHAPTER 5

Multiple Transducer Channel Sweep Systems for Shallow Draft Navigation Projects

5-1. General Overview. Multiple transducer sweep systems are simply an array of single-beam transducers spaced provide 100% ensonification coverage of the bottom (Figure 5-1). The Corps deploys a variety of multiple-transducer channel sweep systems, mainly on inland navigation shallow draft navigation projects. They are primarily used for periodic project condition surveys; however, they may also be used for construction measurement, payment, and clearance work. These sweep systems are also useful in searching for (and evaluating clearance of) hazards to navigation. Multiple transducer systems are also used on some coastal shallow draft projects where multibeam systems may have limited swath coverage. Their prior use on deep draft coastal projects is declining due to increased reliance on multibeam technology. Since multiple transducer systems are similar in operation to single beam systems, most of the quality control and quality assurance procedures covered in Chapter 4 are directly applicable to multiple transducer operations. This chapter provides guidance on the design and operation of multiple transducer systems. Section I contains examples of typical systems used in the Corps. A quality control checklist is at Section II.

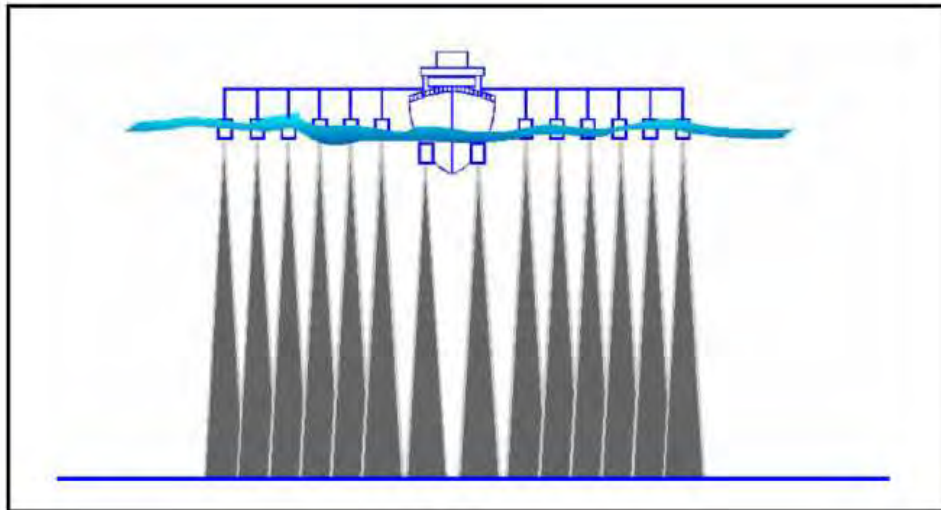

Figure 5-1. Generalized multiple transducer sweep array. Transducers are configured for maximum coverage and bottom ensonification at the project depth.

5-2. Background. Multiple transducer systems were first deployed in the Corps during the early 1970s. These systems were originally designed and developed by Raytheon, Ross Laboratories, Innerspace Technology, and Odom. The primary goal during that time was to obtain 100% ensonification coverage in a channel. These systems replaced the mechanical bar sweeps used

by some districts for project clearance and acceptance—both in shallow- and deep-draft projects. Over the years many inland USACE districts have contracted with Ross Laboratories (Seattle, WA) to develop multiple transducer systems on side-mounted booms. Currently (2013), districts operating multiple transducer systems include: St. Louis, St. Paul, Rock Island, New York, and Mobile.

5-3. Design of Channel Sweep Systems. Channel sweep systems are simply a series of standard single beam transducers mounted vertically on a survey boat, barge, or other stable platform. The transducers are typically mounted on deployable booms attached to the vessel. The number of transducers in a sweep ranges from three up to 32. Resultant bottom coverage is a function of transducer spacing, beam width, and channel depth. Due to high potential motion at the far end of each boom (from vessel roll), boom-sweep systems are normally effective only on calm, restricted inland waterways; unless motion compensation is used. Boom-mounted sweep vessels normally run survey lines parallel to the channel alignment.

a. Sweep width. The sweep width is determined by the type of vessel deployed and project (channel) characteristics. Multi-transducer sweep systems have been designed to cover swaths ranging from 15 ft to over 120 ft. Optimizing sweep width with vessel maneuverability is often difficult--large sweeps using boom-mounted transducers being more difficult to control. Optimizing sweep width requires consideration of vessel characteristics and local conditions.

b. Transducer configuration. One or more transducers may be mounted permanently in the vessel hull. Additional transducers may be mounted on “over-the-side” outriggers or, more commonly, from hinged, retractable booms deployed to port and starboard. The more common systems used today deploy between 5 and 12 transducers on combinations of hull and retractable boom mounts. Figure 5-2 depicts a typical sweep system with transducers mounted in the hull and on port and starboard retractable booms.



Figure 5-2. Survey Vessel Moritz Multiple Transducer Sweep System—54-ft swath with transducers spaced 6-ft c/c. Retractable boom fits flush with hull as shown in left photo. (New York District)

(1) A normal installation for a boom system would include one or more transducers mounted in the hull and two or more transducers mounted on each boom. On smaller vessels typically a five-channel system is used (1 hull, 2 port, and 2 starboard). For most Corps projects, transducers are selected at a 200 kHz frequency (± 10 kHz) and with a wide 8-deg beam angle. Some systems have wider beam widths (e.g., selectable 10 deg or 22 deg). Each channel has its own transmitter, receiver, and depth digitizer board. Both analog and digital depths may be recorded by the operator. The Ross system uses one transmitter common to all channels. By firing all transducers simultaneously from one source, cross talk or timing issues with multiple transmitters is eliminated. The return echoes are then sent to individual receivers and A to D channels.

(2) The port and starboard booms are retractable via hand or hydraulic winch. The stored position is usually vertical--usually against the side of the boat cabin. Some designs have horizontal storage along the hull. The boom assemblies can be totally removed in some designs. The individual struts mounting the transducers are designed with a breakaway feature should the strut strike a floating obstacle. The Ross system also utilizes a custom designed rubber boot that minimizes turbulence around the transducer and protects it when striking the bottom or objects in the water.

c. Transducer beam width and spacing. Transducer spacing is determined by the nominal project depth, transducer beam angle, and desired side overlap between transducers. Transducer spacing typically ranges between 3 and 10 ft, depending on channel/project depth. Ideally, this spacing could be varied for given project depths; practically, however, the spacing is usually set for an optimum minimum depth in most projects. Transducer spacing can be computed by the following:

$$\text{Transducer Spacing} = 2 \cdot (d) \cdot \tan(b/2) \quad (\text{Eq 5-1})$$

where,

d = design project depth
b = transducer beam width

(1) Table 5-1 below details transducer spacing (in feet) for 8 deg and 16 deg beam widths for various project depths (at 100% coverage--i.e., no overlap) are shown below.

(2) From the above, a five-transducer system operating in a 10-ft inland navigation project will cover about a 15-ft swath if a 16-deg beam width is used. Larger beam width transducers may be obtained to increase coverage. Full 100% coverage is not always required on shallow-draft inland projects; thus the spacing can be adjusted for 50% to 75% coverage. Spacing may also be reduced to provide overlapping coverage (i.e., > 100%) for critical strike detection. Coverage is monitored in real-time as shown in Figure 5-3.

Table 5-1. Transducer Spacing for 8 and 16 deg Systems.

Beamwidth	Depth (Ft)							
	10	15	20	25	30	40	50	75
8 deg	1.4	2.1	2.8	3.5	4.2	5.6	7.0	10.5
16 deg	2.8	4.2	5.6	7.0	8.4	11.2	14.1	21.1

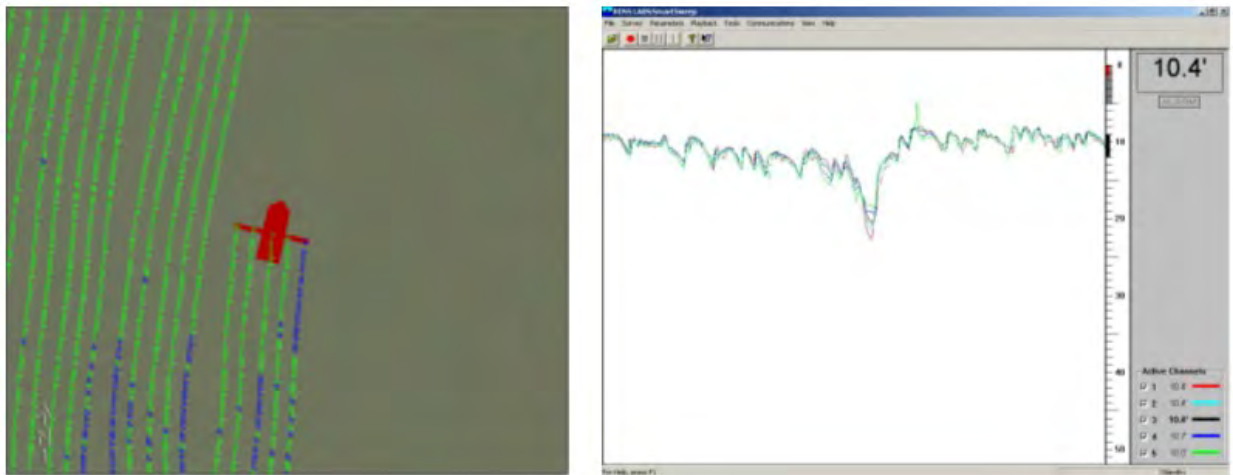

Figure 5-3. Real-time track line plots (“paintings” or "mowings") from each transducer on a 5 transducer 24-ft boat. A swath width of approximately 25 ft is obtained. Soundings shown in blue were coded for real-time shoal detection purposes. Screen capture on right depicts color-coded superimposed profiles from each transducer. (Mobile District and Ross Labs)

5-4. General Survey Operation. Multiple transducer sweep systems are operated similarly to single beam or multibeam systems. Collected depth, positioning, and motion sensor data are input to a hydrographic software system for real-time navigation, display, and storage for subsequent processing.

a. Data collection. Analog and/or digital data recording are available on multi-transducer systems. Digital display modeling techniques are used to assist in interpretation of the large amount of recorded data, especially when 8, 12, 16, or 32 transducers are simultaneously operating. Automatic alarms can be set to indicate strikes above a defined channel clearance grade. Vessel guidance, tracking, and data storage is now performed using standard software

packages (e.g., HYPACK) containing modules for multiple transducer systems. Complete bottom coverage is assured by screen painting swath tracks similar to multibeam systems.

b. Positioning methods. Code phase DGPS (1 to 2 meters) is normally an acceptable positioning method. Total Station positioning may be employed in obstructed areas. Carrier phase GPS (RTK) should be employed when positional or vertical accuracy is more critical—e.g., at the sub-decimeter level. Outer boom yaw alignment correction may be needed if currents excessively crab the survey vessel. This correction can be made using simple flux gate compasses, gyros, or POS/MV systems.

c. Strike detection with sweep systems. The capability for strike (or shoal) detection using channel sweep systems is highly dependent on the operating characteristics of the transducers and the acoustic signal processing system, along with coverage patterns, floating plant maneuverability, and sweep overlap. Optimum transducer spacing and beam angle are essential for strike identification given a nominal project depth. Object detection is best when operating at slow speeds to ensure multiple hits. Repeated passes are recommended for confirmation or assured clearance. Obtaining 100% coverage with an acoustic sweep system may not provide full assurance that all potential strikes have been observed. Many objects can deflect acoustic energy such that they are below the detection threshold of the echo sounder. Some large rock fragments can exhibit “stealth-like” acoustic characteristics to vertically mounted transducers, and thus avoid acoustic detection. In such cases, it is best practice to run overlapping swath runs that will provide 200% (or more) bottom coverage. On critical investigations, side scan survey methods should also be considered.

5-5. Multiple Transducer System Quality Control and Quality Assurance. Multiple transducer quality control requirements are essentially identical to those for single beam surveys (Chapter 4). Multiple transducer quality assurance Performance Tests can be performed similarly to single-beam and multibeam Performance Tests covered in their respective chapters. The following paragraphs amplify some of the criteria that are unique to multi-transducer systems.

a. Velocity and draft calibration. Multiple transducer system sound velocities are calibrated identically to single beam systems—i.e., periodic bar checks and velocity probes. In shallow water, velocity changes are normally not as critical. Maintaining and monitoring transducer draft and alignment throughout the booms is especially critical. Calibration of the multi-transducer system is performed similarly to that of single transducer systems. Index and/or draft errors of the boom transducers are individually stored in the hydrographic survey processing system as corrections. Removal of any one of the boom transducers for any reason (cleaning, etc.) constitutes a re-installation/boom calibration procedure.

b. Boom calibration procedure after installation. The survey vessel must be in protected calm water for this procedure. The booms are lowered and leveled by the best possible means available. Roll motion must not be allowed at this time. A bar check is performed on the hull transducer. This will minimize the index and draft errors and establish the same speed of sound

for all transducers. Next the bar (or plate) is moved outward from the hull transducer (using a separate boat) to the nearest boom transducer on one side of the survey vessel. The hull transducer soundings are compared to the sounding values recorded at the hull transducer. Any discrepancy found is recorded as a combination of draft and index error. The opposite (negative) of this recorded value will be applied to all soundings from this particular transducer until the transducer is physically moved from the fixed position in the boom. All boom transducers are compared to the hull transducer by the same procedure. The area selected for the boom calibration should be where no changes in temperature or salinity could change the speed of sound during this calibration. Clearly noticeable particles in the water column may also affect the speed of sound.

c. Periodic calibration of Ross Dolphin Sweep System (Philadelphia District Method). Periodic calibration of Ross Dolphin sweep systems is performed using basically the same criteria required for a single transducer system. Once a month, all transducers in the hull are calibrated, utilizing a standard bar lowered to the project depth directly under the vessel. Transducers in the port/starboard beams are calibrated on an annual basis. On a daily basis, a Ross ball check device, which is mounted as part of the referenced transducer pod, is utilized to calibrate the average speed of sound utilizing a $3\frac{1}{2}$ -deg transducer. The $3\frac{1}{2}$ -deg transducer is used to assure that the depth reference is as close to a true vertical distance as possible. A sound velocity profiler is also used daily to verify the ball check calibration procedure. Maintaining and monitoring the transducer draft(s) is especially critical. Each transducer channel in the sweep is adjusted similar to the procedure used in the single transducer systems.

d. Lock chamber calibration. When a lock chamber with a clean, smooth floor is located in the district, multiple transducer sweep systems may be simultaneously calibrated. Calibration can be performed at varied surface elevations by drawing down the lock to desired intervals—i.e., the project depth. The lock chamber affords a stable water surface that eliminates sea state effects on outer boom transducers. Individual transducer channels are calibrated and adjusted to read true depths.

e. Motion compensation requirements. Boom sweep systems are normally used on shallow draft inland projects where sea state conditions are typically calm. Thus, full X-Y-Z inertial motion sensors are rarely added to these sweep systems unless sea states cause excessive errors. Roll correction is especially critical if there is excessive motion at the outer transducers. Physical movement of the outer transducers will determine whether surveys should continue under adverse sea conditions, or whether POS/MV and IMU systems are required. Small roll errors can significantly affect depth readings on long boom systems--e.g., a 1-deg roll on a 25-ft boom causes approximately a 0.4-ft error in the sounding. Excessive heave should not be a problem on calmer inland navigation projects where sweep systems are deployed.

(1) Roll compensation. Roll should be compensated for and corrected in the processing software if the outer transducer on a boom experiences movement in excess of allowable tolerances for the project. Smaller boat systems with short outriggers would be less subject to

roll errors, so compensation would not be required. Beam steering position and slope corrections due to excessive roll and pitch are usually negligible for shallow-draft projects when wide beam transducers are used; thus the need for these corrections would be minimal. Typically Flux gate compass corrections are used with smaller sweep systems for roll correction input.

(2) Yaw correction. Most multi-transducer sweep vessels surveying at slow speeds in river currents will exhibit yaw in order to maintain heading. Therefore, yaw correction is usually necessary. Boom alignment due to vessel yaw is controlled using a flux gate compass, a gyrocompass, or inertial-aided POS/MV techniques. Software must correct each transducer offset (lever arm) relative to the positioning antenna in addition to correcting eccentricities due to yaw. This is done using similar techniques covered under the chapter on vessel orientation systems. Full yaw correction is critical.

(3) Heave correction. Only required in excessive sea states.

(4) Pitch bias. Usually negligible given slow sweep speeds on inland projects.

(5) Latency. Latency between the positioning system and the multiple transducers is calibrated similar to single beam or multibeam systems.

(6) Fixed lever arm offsets. Horizontal lever arm offsets of individual transducers are measured relative to the vessel center of mass--the point where an inertial MRU unit should be located. Vertical offsets (draft) are relative to the water line and are determined from a bar check. Parameters for multiple transducer systems are entered in processing software in a variety of methods--Figure 5-4 depicts a typical multiple transducer system offset table.

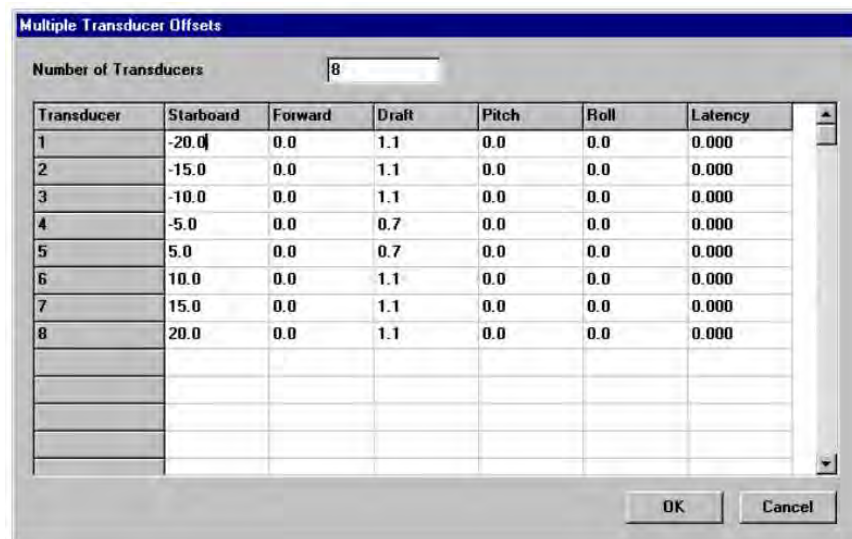

Transducer	Starboard	Forward	Draft	Pitch	Roll	Latency
1	-20.0	0.0	1.1	0.0	0.0	0.000
2	-15.0	0.0	1.1	0.0	0.0	0.000
3	-10.0	0.0	1.1	0.0	0.0	0.000
4	-5.0	0.0	0.7	0.0	0.0	0.000
5	5.0	0.0	0.7	0.0	0.0	0.000
6	10.0	0.0	1.1	0.0	0.0	0.000
7	15.0	0.0	1.1	0.0	0.0	0.000
8	20.0	0.0	1.1	0.0	0.0	0.000

Figure 5-4. Multiple transducer lever arm, latency, and draft Offsets input into the survey data collection system. (HYPACK, Inc.)

f. Squat tests. At typical slow sweep speeds vessel squat and settlement should be minimal. However, this should be checked by performing a Squat Test”—see Chapter 4.

g. Vessel speed and shoal/strike detection hits. Vessel speed should be controlled such that objects or shoals above project grade receive at least three solid acoustic hits during a pass, or accumulate on overlapping passes. The depth update rate for each transducer channel must also be factored into the maximum speed determination. For dredge payment surveys, the maximum update rate shall be used in recording depths from each transducer channel. Data gaps can result if too high a velocity is maintained and individual channels do not update at a rapid enough level. Depths should be recorded at the maximum rate possible with the recording and processing system.

h. Quality assurance Performance Tests. Performance Tests are not required on all surveys; however, they should be periodically run during maintenance periods or other available opportunities (lay days). The frequency which Performance Tests should be performed is vessel/system dependent, and largely rests on the judgment of the system operator. The stability (repeatability) of results from past tests will provide an indication of the continued reliability of the data. If repeated tests yield stable results, then only infrequent (monthly or quarterly) tests would be indicated. Performance Tests are recommended for dredge clearance or payment surveys.

(1) QA Performance Tests with multiple transducer systems may be performed similar to single beam and multibeam systems, i.e., comparisons between two independently collected full data sets over the same area. The Reference Surface may be developed using data from only the hull-mounted transducers, thus minimizing yaw and roll effects. Alternatively, and a preferred option, comparisons with Reference Surface datasets from other survey vessels may be used. If available, tests within a confined lock chamber can be made. Follow the QA Performance Test software and analysis procedures described for multibeam systems in Chapter 6.

(2) Performance Test results will include an assessment of biases on the outer boom transducers, along with 95% standard deviation results. Any overall large biases between the test datasets should be investigated and resolved.

5-6. Selecting Recorded Depths and Estimated Accuracies. Selecting representative depths should follow the same guidance used for single beam and multibeam surveys—see the guidance at Chapter 2. Depths can be displayed in numerical values or color-coded to various ranges. Contour depth display options may also be used. If depths are binned for plotting purposes, the shot depth nearest the bin centroid should be used. Shoal biased (i.e., minimum) or average depths should not be used to evaluate dredging progress or payment—the average or median depth within a bin is recommended. Data thinning should be kept to a minimum for payment surveys. Therefore, bin sizes should be kept as small as possible.

a. Estimated depth accuracy results. Depth measurement relative accuracies in shallow draft projects (<15 ft) on firm bottoms are usually around the ± 0.2 -ft level with a properly

calibrated and operated system. Accuracy will degrade in deeper depths, or if sea or river wave conditions impact the vessel stability or motion corrections. If quality assurance Performance Tests are performed, then statistical data from those tests will yield an indication of the internal accuracy (i.e., standard deviation and repeatability) of the system. Actual or historical Performance Test results should be noted on the survey drawings and metadata files.

b. Reporting the estimated accuracy of measured depths. As noted in Chapter 3, determining the uncertainty of a depth measurement is difficult, and only an estimate is possible. In many inland applications, the uncertainty of a depth observation will be primarily dependent on the accuracy of the water surface elevation measurement. River stage interpolations over 10 to 30 miles between gages may result in stage uncertainties exceeding ± 1 ft. If local RTN/RTK elevation methods are observed from nearby primary gage benchmarks, then the uncertainty of observed depths in a shallow draft project may approach the ± 0.3 -ft level, given the likely ± 0.2 -ft accuracies achievable from the depth measurement system. Noting the estimated TPU is recommended on final survey products; especially those furnished to the public.

c. IHO standard. Surveys performed for nautical charting purposes should note the intended IHO SP-44 they were performed to meet. In general, most USACE navigable waterways should be surveyed to meet the IHO Special Order category.

SECTION I

Examples of Corps Multiple Transducer Survey Systems

This section contains descriptions of multiple transducer sweep systems currently operated by USACE districts. Some of these systems may have been subsequently modified or replaced. Descriptions of superseded systems are retained should these designs have application in future work.

5-7. Mobile District Tuscaloosa Site Office Sweep Systems. The Mobile District Tuscaloosa Site Office operates four multiple-transducer automated sweep survey systems utilizing depth sounding hardware manufactured by Ross Laboratories and HYPACK data collection and post processing software. The systems are used to provide data collection for Inland Electronic Navigation Chart (IENC) update and support for dredging activities and project conditions along over 700 miles of the shallow-draft 9-ft x 200-ft navigation channels of the Black Warrior–Tomigbee and Alabama River Systems. Following are descriptions of the systems.

a. General description. The Tuscaloosa Site Office operates three (3) trailerable 24-ft sweep survey vessels and the 60-ft sweep survey vessel E.B. WALLACE (see Figure 5-5). The three 24-ft small-boat systems have a total of five transducers with four being attached to hydraulically operated, retractable booms and strut assemblies and one being mounted amidships through the hull. The small boat systems provide full 25-ft swath coverage of the bottom with no gaps at water depths of 17 ft while performing data collection survey operations. The E.B. WALLACE has a total of 12 transducers with 10 being mounted on spring-loaded struts attached



Figure 5-5. Tuscaloosa Multi-transducer sweep boats. E.B. WALLACE on left and one of three 24-ft vessels on right. (Mobile District)

to two 30 ft hydraulically operated retractable booms and two being mounted amidships through the hull. The E.B. WALLACE provides a complete 70-ft-wide swath of the river bottom with each pass of the vessel. All transducers are spaced at 5-ft intervals along the boom and operate at frequencies of 200 kHz. The E.B. WALLACE has dual beam selectable angles of 10 and 22 deg and the small boats have a beam pattern of 10 deg at the 6db level. All the vessel's electronic components are rack mounted in custom cabinets and located in climate controlled cabin areas. (Note: The E.B. Wallace is being updated to 10-deg. Low “Q” transducers identical to those on the three small boats for better shallow water operation. These transducers allow sounding to within one foot from the face of the transducer.)

b. Survey procedures. Data collection is performed for each assigned surveying effort by running sweep lines that are parallel to the navigation channel. This method is also known as “mowing the lawn” or “painting the screen,” and provides data coverage of the entire navigable water area or river “bank to bank” survey.

c. Transducer calibration and quality control. Transducers are calibrated with daily “ball checks” using the Ross Labs lead ball check assembly. Traditional monthly bar checks are also made using steel angle iron and a calibrated chain to verify the transducer drafts. Checks are also performed over fixed objects such as lock and dam miter sills to provide additional assurance of depth accuracy. Independent verification is also made by comparisons of hydrographic data produced with the sweep system with simultaneous collected data produced by A-E contract survey vessels.

d. Vessel positioning. Positioning is provided through a Trimble SPS 461 GPS system with dual antennas providing differential correction signals from USCG broadcast sites. In addition, the Trimble SPS 461 GPS receiver is equipped with a real-time kinematic (RTK) positioning system module for both horizontal and vertical positions. The RTK module uses an

Intuicom cellular bridge to receive a vendor-supplied network of corrections from a series of reference stations across four southeastern states: Georgia, Alabama, Tennessee, and Mississippi. The service provides network corrections that include data from both the US NAVSTAR and Russian GLONASS satellite systems. Each vessel incorporates a digital compass and a Honeywell HMR3000 roll and pitch sensor equivalent to a Micro Strain model 3DM-GXI.

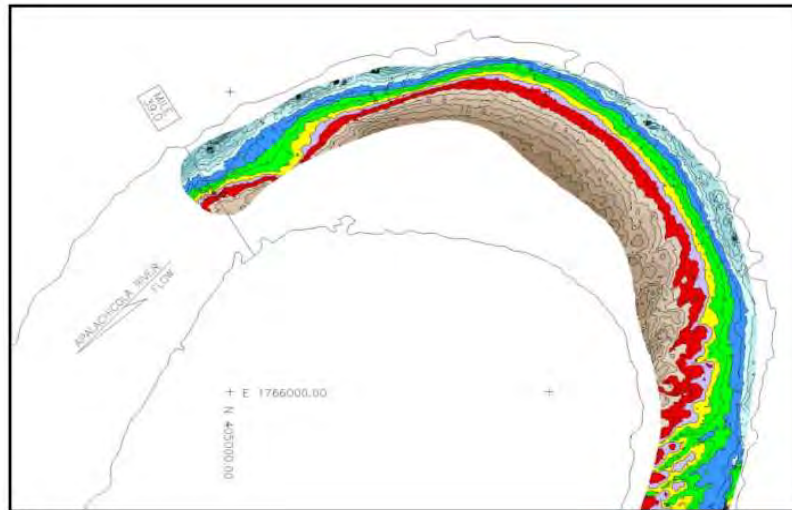

Figure 5-6. Color filled contour map plot near Mile 39 of the Apalachicola River. (Mobile District)

e. Data processing. Sweep data in digital format is recorded and stored onto CDs and DVDs and is either transmitted via email, FTP, or delivered to the office for editing and post-processing using HYPACK software. The data is processed into full color 30- x 42-in plan-view drawings of each survey area. The finished plots consist of color filled depth contours with elevation labels—see example at Figure 5-6. All data points collected during the sweep survey are used in the post-processing effort with various levels of data thinning being performed to achieve desired bottom mapping results.

f. Data distribution. End use of the processed data consists of not only hard copy plots but also digital dredging files and publicly available X-Y-Z data points. Contract rental dredges are given digital plans and detailed cut boxes that are displayed using government-furnished DREDGEPACK software from HYPACK, Inc. Digital X-Y-Z data is also made available via the Tuscaloosa Homepage Internet site for FTP download by vendors desiring to produce electronic charting products as well as display in a publicly accessible, on-line, interactive GIS system. The available data set consists of edited ASCII X-Y-Z format sounding points from which the electronic chart vendor will utilize to produce contour maps. Such contouring will be incorporated into charts depicting the shoreline and other physical features of the river system. Vendors providing electronic charting systems will be responsible for providing the finished chart that will ultimately be displayed on a vessel by the end-user.

g. On board equipment. Table 5-2 lists the survey instrumentation on the 24-ft vessels and the 60-ft E.B. WALLACE:

Table 5-2. Ross Model 4810 Sweep System Components.

Ross 962 controller (5-channels 24-ft boats and 12-channels E.B. WALLACE)
Ross Transducers - E.B. WALLACE, 12 @ 200 kHz, dual beam (10 and 22 degree beams)
Small Sweep Boats, 5 @ 200 kHz, 10 deg beam width
Ross 5150 one-man bar/ball check and underwater housing
Ross 9750 roll, pitch, and heading sensor. (Honeywell HMR 3000 series)
Trimble SPS 461 GPS with RTK module and Intuicom cellular bridge
Small-HP desktop color printer
Panasonic Tough Book 30 data collection computer with docking station. Consists of a
1.8 GHz Pentium processor with 2 GB of RAM, 160 GB hard drive
Dell 17-in ultrabright helm monitor
Dual ICOM model IC-M422 marine radios, integrated MXA-5000 AIS commercial vessel
receiver with display from GARMIN GPS Model 430
Satellite telephone

5-8. St. Louis District Ross 875-4 Shallow Water Portable Sweep System. The Ross Laboratories 875-4 shallow water portable sweep system consists of four transducers on a lightweight 18-ft portable boom, which can be temporarily mounted on small skiffs or john boats (Figure 5-7). The watertight system operates on 12v DC. It has four to eight channel data collection options, can work in shallow water (to 1.5 ft), and operates with narrow beam 200 kHz transducers.

a. Real-time display. The multi-channel depth sounder system is able to display all channels on the system's 10-in color CD display; with each channel being represented by its own unique color. It also has adjustable tracking gates for each depth channel that can continuously track a changing seabed without user input.

b. Transducer specifications. The depth sounder operates at a frequency of 200 kHz, using four transducers (either 8-deg @ -3dB or 12-deg @ -6dB) with a six (6)-ft nominal spacing. The depth sounder system outputs a custom NMEA 0183 string to HYPACK software.

c. Data storage and display. The depths are stored on the internal hard drive media for future playback and printing. This data is downloaded and transferred to an office PC running Ross Multi-Channel Playback software using a USB Memory Card.

d. Accuracy. The depth sounder subsystem is based on a crystal-controlled clock. Depth measurement accuracy is a function of bottom type, bottom slope, and transducer beam angle. An echo detection algorithm is used to first determine that an echo has adequate echo strength to

be digitized and then calculates the digitized depth from the leading edge of that same echo signal. This algorithm is designed to reduce the type of errors related to echo signal rise time.



Figure 5-7. Ross 875-4 sweep system surveying the London Avenue Canal in New Orleans, LA, after Hurricane Katrina (2005). (St. Louis District)

e. Processor software. The main task of the processor software is to sample the four (4) channels of analog information at a rate of 50,000 samples per second for each channel. It then calculates the depth for each channel. The software is also responsible for recording the raw sounding data to the internal hard drive, displaying the data to the screen, and responding to user commands.

5-9. New York District Sweep System. Figure 5-8 shows the 25-ft survey vessel NYSB1 operated by the New York District. This boat is equipped with a multiple transducer sweep system (Ross Mini-Sweep Transceiver). The original system was developed by Ross Laboratories and is used to determine clearance during the rock excavations in New York Harbor deep-draft channel deepening projects.

5-10. St. Paul District Sweep System. This section describes two multi-transducer sweep survey systems operated by St. Paul District on the Upper Mississippi River. Both systems are boom-

mounted systems with a five-transducer array, mounted on 25-ft Sea Ark workboats. The systems were designed and installed by Ross Laboratories Inc. The systems are primarily used



Figure 5-8. Survey Vessel NYSB1 Multiple Transducer Sweep System.
(New York District)

on project condition and dredge payment surveys of shallow-draft projects in the Upper Mississippi. (Note: the St. Paul District is currently (2013) replacing the five-transducer system with a six-transducer system mounted on a 24-ft aluminum catamaran vessel supplied by Armstrong Marine of Port Angeles, WA.)

a. Five-transducer system. The five-transducer vessel is boom mounted on a 24-ft Sea Ark boat powered by twin 150-HP outboard engines (Figure 5-9). The survey system is a complete 12-volt system with DGPS, roll sensor, and fluxgate compass all integrated into HYSWEEP data collection software. The five transducers are interchangeable from 10-deg to 20-deg beam angles for shallower water. All surveys are accomplished longitudinally and usually at speeds of under seven knots. Sweep data is edited in HYSWEEP software and then e-mailed to the Fountain City Project Office for plotting and analysis.

b. Lock chamber calibration procedures. The electronics are calibrated monthly using an aluminum bar check inside a lock chamber with the gates closed. The lock floor chamber depths are checked using a lead line or pole. A bar check is then used to calibrate the sounders with the depths at 5, 10, 15, and 20 ft. All transducers are then forced to read the same depths on the data collection computer. A predetermined survey line is set up in the lock chamber and the boat then runs this line. The recorded depths are compared with the chamber depths. The Ross ball check

is then calibrated at the same time for future daily or job specific use for project condition and /or payment surveys.



Figure 5-9. St. Paul District Five-Channel Ross Mini Sweep System on a 24-ft boat.

5-11. Rock Island District Sweep System. The Rock Island district currently operates two Ross Sweep Systems; one mounted on the MV Holling, a 34-ft catamaran vessel utilizing 10 transducers, the other a 9-channel system installed on the MV Heinz, a similar sized cathedral hull vessel.

5-12. Philadelphia District Sweep System. The Philadelphia District operated a ten-transducer boom-mounted Ross sweep system aboard the S/V Shuman until 1999. It was used for clearance and dredge payment on deep-draft navigation projects in the Delaware River, Delaware Bay, C&D Canal, and Chesapeake Bay. It was replaced with a RESON 7101 multibeam system currently in use today.

a. Four of the 10 transducers are mounted directly to the hull of the catamaran-type survey vessel. Six transducers are boom mounted, three to port side and three to the starboard side boom. Transducers are calibrated with a bar check monthly. Daily, a Ross ball check was performed to monitor the drafts of the hull-mounted transducers. A sound velocity profile was also used calibrate water sound velocity changes.

b. Vessel sweep speed was normally between 3 and 6 knots. Sweep data from all transducers was collected by time, not distance along the track line. Therefore, vessel speed must be controlled to avoid gaps. A fluxgate compass (or gyroscope) was interfaced with the data collection system to correct for yaw of the vessel and boom assembly--allowing for direct coordinate computation on each transducer. Both microwave and later code DGPS positioning were used.

(1) Sweep line spacings were designed for 20% side overlap. Cross-line checks were optionally run in order to monitor quality control of the sweep data. Comparisons were made using either a single transducer or full terrain models.

(2) Sweep data was edited through use of the system monitor aboard the vessel. Editing and review were made in plan or section format and the database corrected as required. Final plot scales and densities were selected depending on the nature of the project. In most instances, depth data must be selectively "thinned" for plan view plots at normal scales. Other options allow for selecting fixed cell (window) sizes for site plan plots or filtering out and plotting strikes above a preset grade.

(3) Cell/window size can be automatically determined -- typically 5-ft or 10-ft square. Since one or more depths may have been recorded within a cell, different techniques were used in determining the final value displayed or in material quantity computations. Normally, either the least depth or average depth within a cell was used. This value was then shifted to the cell centroid for plotting purposes. This process for selecting, thinning, and shifting of data must be thoroughly understood by those evaluating the data relative to contract performance.

5-13. Jacksonville District Raytheon 719 CSS (Channel Sweep System). One of the original Raytheon multiple transducer systems developed in the 1970s was designed without boom arrays. Side transducers were temporarily mounted to the hull of the boat, as shown in Figure 5-10. With only three transducers, sweep coverage was limited based on the beam width of the vessel; however, higher vessel speeds could be attained without boom restrictions. Depth data was recorded on stylus sparked paper, with offsets for each transducer. This system was used for visual (real-time) dredge clearance estimates. Figure 5-11 shows an analog representation from three transducers. Each transducer is offset by a fixed amount on the same graphical record. Visual interpolation of these analog records for strikes above grade was difficult. Interpretation becomes even more difficult as the number of transducers increases. This system's use was discontinued in the 1980s.

5-14. Detroit District 120-Ft Strike Detection Systems. This section describes multiple transducer sweep systems that were deployed on 100-ft vessels by the Detroit District during the 1980s and 1990s. The district deployed two such systems--one in Detroit and another at Sault Ste. Marie, MI. They replaced the manual sweep rafts previously used for strike detection. These systems have since been replaced by multibeam systems on small 26-ft survey vessels. The design and operation of these systems was unique and warrants description in this chapter.



Figure 5-10. Raytheon 719 CSS three-channel hull mounted sweep ca 1970s. (Jacksonville District)

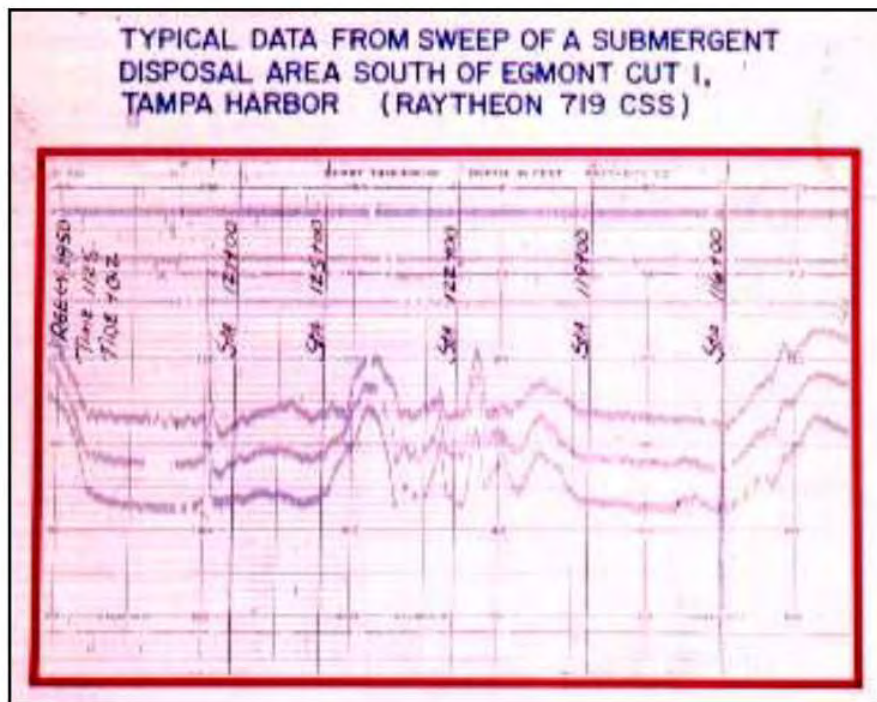

Figure 5-11. Raytheon 719 CSS multiple transducer analog record ca 1980. (Jacksonville District)

- a. An Odom Echoscans multiple transducer channel sweep system was deployed from a 200-ton, 100-ft long by 30-ft beam by 7-ft draft, self-propelled barge containing 32 separate

transducers spaced 3.75 ft O/C (Figure 5-12). The transducers were mounted along a catwalk that extends 10 feet beyond each end of the vessel. This provides for a 116.25 ft length or about a 120-ft swath at typical project depth. These systems were used for strike detection in rock cut channels. Obstructions may be caused by ice jams, propeller wash, or large vessels dragging anchors that lifts and loosens rock material within the channels. Each transducer had a large enough beam width to provide overlapping coverage in typical 25- to 30-ft project depths found in the Detroit, St. Clair, and St. Marys river channels. The operating frequency was 214 kHz with pulse duration of 0.1 msec. The transducers are small ceramic discs 1.55 inches in diameter. The transducer beam width is 12 deg at -3dB and 17 deg at the -6 dB power points. Transducers were individually calibrated using standard bar check devices supplemented with velocity probe data and ball-check methods. A 32-ft calibration bar was employed in order to check every transducer. Calibration was also performed in a lock chamber at the Soo Locks where 30-ft depth can be obtained. Each transducer had separate draft and sound velocity settings. This type of vessel usually worked in conjunction with a crane barge (derrick boat) for removing loose rock and other debris within navigation projects.

b. The vessels were propelled by two Schottell, 360-deg, hydraulically operated rudder propellers, one at each end of the vessel. They were driven by 240 HP engines. The vessels have no keel so all direction and movement is dependent on the rudder-propeller system. The vessels were controlled by the direction and amount of thrust from the rudder-propeller. The vessel was navigated to work sites as any 130-ft long vessel. The rudder was manually controlled and a handwheel from each rudder-propeller with arrows indicating thrust direction allows the boat operator to direct the engine's output. Throttles located in the center of the handwheel provide the thrust controls. Auxiliary power was obtained from two 30 kW generators operating at 3 phase and 480 volts.

c. The vessels were operated sideways while sweeping. The boat operator controlled the vessel's speed and direction with a single handwheel and throttle. The Schottell unit's actual direction and amount of thrust was controlled by a computer interfaced to a gyrocompass and autopilot. The computer maintained alignment of the vessel at 90 deg to the direction of survey.

d. The sweep vessels were originally positioned using Del Norte microwave range-range and range-azimuth modes. In the 1990s positioning was converted to differential GPS. Data acquisition was originally performed using Comstar Echo Scan software running on a HP 9000 computer. Processing originally required 16 hours for each 8 hours of survey data collected--requiring a 24-hour processing operation. Once PC-based HYPACK software was added in 1994, data processing time was reduced substantially. Since only "strikes" above grade are significant, processing and/or plotting of data below grade could be eliminated.

e. Original staffing on the sweep vessel in 1986 was nine persons: three (3) Wage Grade vessel operators and six (6) GS survey technicians. With DGPS positioning and enhanced acquisition software, this staffing was reduced to four (4) persons by 1995.

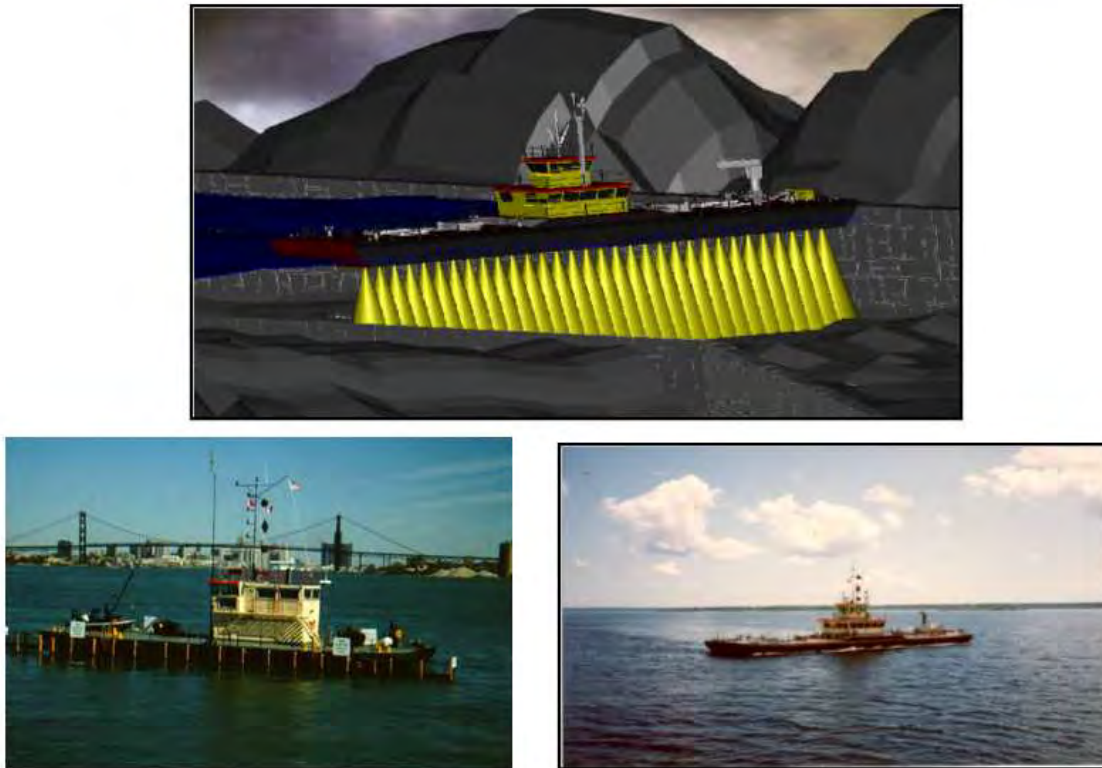

Figure 5-12. Detroit District 32-channel 120-ft sweep systems used on deep-draft navigation projects. On left, SV Bray in Detroit River (Detroit Area Office). On right, SV Bray on St. Marys River (Soo Area Office).

SECTION II

Recommended Quality Control Checklist for Multiple Transducer Sweep Systems

The following Table 5-3 lists quality control and calibration checks recommended for multiple transducer sweep systems. These criteria are similar to those required for single beam systems—see Chapter 4. These criteria are primarily applicable to systems operating in shallow draft waterways. For deeper draft projects, quality control and calibration checks should follow that of single beam systems.

Table 5-3. Recommended Quality Control Checks for Multiple Transducer Sweep Systems.

Sound velocity calibration	Perform twice daily, or more often if required.
Bar/ball check draft calibration	Perform daily on dredging surveys—middle transducers. Periodically on other surveys. Check as many transducers as possible. Annually check all transducers.
Dynamic draft calibration	Check and monitor short- and long-term draft corrections for all transducers, particularly on small boats where loading changes may impact short-term draft.
Vertical Elevation Check (RTK)	Twice daily calibration at tide/staff gage.
Roll motion correction	Required if significant outer boom roll motion exists.
Yaw correction	Flux gate compass correction usually adequate.
Heave correction	IMU/MRU rarely required unless excessive motion.
Pitch correction	Typically negligible in calm waters at slow speeds.
Latency correction	Periodically check and monitor.
Squat correction	Usually minimal at slow speeds ... verify at installation.
QA Performance Test	Perform periodically during maintenance periods. Recommended on dredge payment or clearance surveys. When possible, compare with different vessels. Perform lock chamber calibration if available. Note results on transmitted drawings and metadata files.

CHAPTER 6

Acoustic Multibeam Survey Systems

6-1. General Scope and Applications. This chapter provides guidance for the calibration, quality control, and quality assurance of multibeam survey systems used on surveys of Federal navigation projects and water control structures. Only general operating principles are outlined in this chapter. Comprehensive instructions for installing and operating specific multibeam systems, including the data acquisition, processing, and editing of data from these systems, are found in manufacturer's operating manuals and software processing manuals specific to those systems.

6-2. Background. The US Navy developed multibeam swath survey technology in the early 1960s for deep-water bathymetric mapping—i.e., the “Sonar Array Survey System—SASS.” In the 1980s, this multibeam technology began to be developed for shallow water applications. In the early 1990s, John E. Chance (now Fugro) of Lafayette, LA, configured a multibeam system (“HI-MAP”) for USACE revetment surveys on the Lower Mississippi River. This HI-MAP multibeam system was first deployed in support of USACE during the Mississippi River Flood of 1993, performing high water surveys over levee breaches in the St. Louis District. Subsequently, in the mid 1990s, USACE inland waterway and coastal districts began to acquire these shallow-water multibeam systems. Over 40 multibeam systems are currently deployed in 24 USACE districts (Table 6-1). It is expected that the use of multibeam systems will gradually supplant single beam systems for surveys of most deep-draft navigation projects. Multibeam systems, when coupled with digital side scan imaging systems, have also become primary strike, channel clearance, and shoal detection methods in USACE. When properly deployed and operated, the accuracy, coverage, and strike detection capabilities of multibeam systems now equals or exceeds that of traditional vertical single beam sounding methods. However, there are still many project applications where single beam systems are more effective and efficient than multibeam systems.

Table 6-1. Multibeam Systems Deployed by Corps Districts (2012)

New England - 2 systems	Los Angeles - 1	Galveston - 3
New York - 3	San Francisco - 1	Tulsa - 1
Philadelphia - 3	Portland - 2	St. Louis - 2
Baltimore - 1	Seattle - 1	Nashville - 2
Norfolk - 2	Vicksburg - 1	Louisville - 1
Wilmington - 1	Memphis - 1	New Orleans - 1
Savannah - 1	Huntington - 1	Detroit - 2
Jacksonville - 4	Buffalo - 1	Mobile - 4

6-3. General USACE Applications. Multibeam systems are primarily used to obtain complete coverage of deep-draft navigation projects; in particular, project condition surveys, dredging measurement, channel clearance, and constructed construction payment surveys. Multibeam systems can also be configured for waters-edge to waters-edge coverage (i.e., over 180 deg swath), allowing side-looking, full-coverage underwater topographic mapping of constricted channels, lock chambers, revetments, breakwaters, dams, and other underwater control structures. Most multibeam systems now collect acoustic backscatter information that can produce digital side scan imagery simultaneously with the topographic mapping data; an advantage in locating underwater rock, hazards, shoals, or other objects (strike detection)—see Appendix Q. Multibeam acoustic frequencies and signal processing methods may be configured to match the survey requirements--dredging measurement and payment, strike detection, structure mapping, bottom classification, etc. Some systems can provide near real-time data collection, filtering, editing, quality assessment, and display; along with near real-time (i.e., on board) data processing, plotting, and volume computations. Thus, final plan drawings, 3D terrain models, and dredged payment quantities can be completed in the field the same day the survey is performed. Additional USACE applications are described in Section II of this chapter.

SECTION I

Principles of Multibeam Depth Measurement

6-4. General. Multibeam systems generate a single sonar pulse from which detailed terrain or channel cross-section (swath) data can be developed, as illustrated in Figure 6-1. A single transducer forms a fan array of narrow beams that result in acoustic travel-time and angular measurements over a swath that varies with system-type and bottom depth--typically mapping an area 2 to 14 times the channel depth with each array pulse. Some multibeam systems can obtain 50 or more swath profiles (cross-sections) per second with hundreds of depths recorded on each profile/section, along with additional backscatter or snippet information with each depth. Multibeam systems can obtain 100% bottom ensonification coverage, and can provide high-resolution footprints when narrowly focused beams are formed. A variety of acoustic frequencies are available from manufacturers—100 kHz to 500 kHz being most common on USACE systems. Multibeam system internal depth accuracies are typically better than ± 0.8 ft (95% relative standard deviation) with repeatabilities usually well less than 0.2 ft (at 90-deg restricted array limits). Multibeam accuracies degrade at the outer beams—typically beyond 40- to 50-deg from nadir.

6-5. Depth Measurement Principles. All multibeam systems use the same basic approach to depth measurement. A lateral swath of sea floor is illuminated acoustically and the returning echo signals are processed into vertical depths. All outgoing and incoming sonar is transmitted and received at a single transducer head. Travel time estimates are converted into slant ranges, horizontal off-center distances, and then depth by applying beam angles and sound velocity profile and refraction corrections. Multibeam sonar systems employ various acoustic and electrical signal processing techniques to determine the slant range and angular measurements of seabed points along an array generated from a single acoustic pulse. These include amplitude

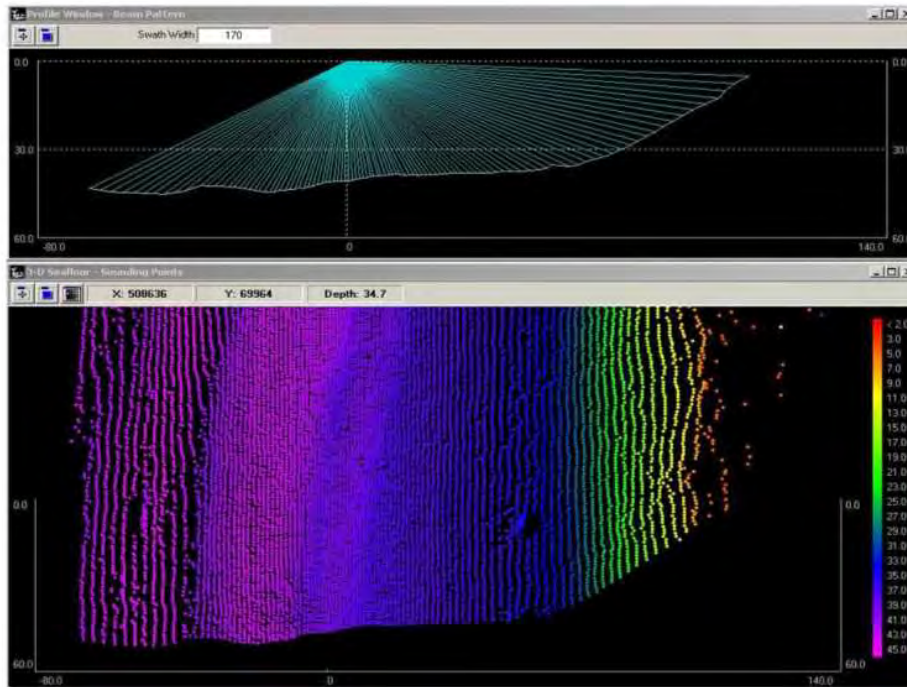

Figure 6-1. The upper image shows a real time display of a multibeam channel cross-section from a single ping. The lower figure shows a real-time plan view image of data collected along a channel and revetment bank on the Mississippi River. The multibeam transducer head was tilted to maximize coverage to starboard (up the revetment bank). Note that coverage spreads out on the outer ends of the port and starboard beams. (St. Louis District)

detection, phased array beamforming, interferometric (phase comparison), and various combinations of all these methods. The signal processing method(s) used on any particular multibeam system is often proprietary. In general, combinations of amplitude detection and transmit or receive beamforming are the most common methods. Phase comparison (interferometric) techniques may also be used directly or included within some proprietary systems. Many of these acoustic measurement techniques were derived from RF and radar signal processing.

a. Amplitude detection relies on finding the time of a beam's interception with the bottom, typically determined using a center-of-energy method, or matched filter method. Phase detection relies on finding the time of the zero phase crossing using two or more subsections of the receive array. Amplitude detection is typically used for the inner beams (e.g., 0 deg to 45-deg off-nadir) and phase detection is typically used for the outer beams (e.g., 45 deg out to 100-deg off-nadir)—see Figure 6-2. The changeover point between amplitude and phase detection is

processed by various methods, such as absolute cutoff, real-time analysis of each beam, and combinations of amplitude and phase. Depth accuracy can change at the bottom detection transition points.

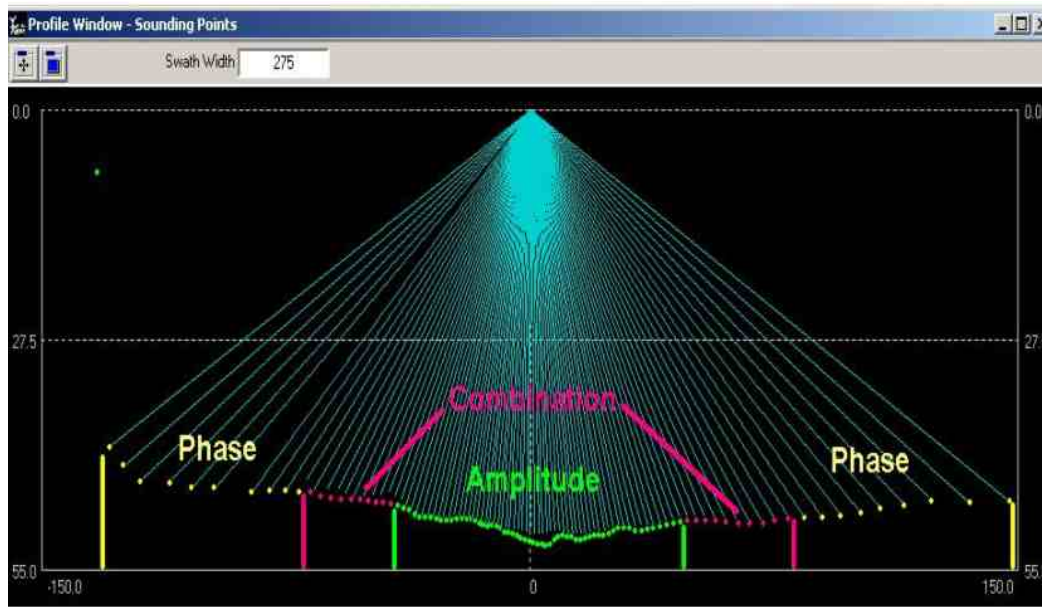

Figure 6-2. Amplitude and phase detection methods used in measuring depths over a typical multibeam array. The "combination" is the changeover area between phase and amplitude detection processing.

(1) Physical beamforming. A physically beamformed system uses a common projector and an array of receive elements physically pointed in the desired direction. Depth is determined based on the amplitude of the return signal (the center-of-energy detection method). Beam parameters are determined by the physical shape of the receive elements.

(2) Electronic beamforming. Electronic beamforming is generally based on electronic filter techniques to differentiate between individual echo contributions from different directions. Basically, each beam is formed by filtering out unwanted components. Depth is resolved based on center-of-energy or phase estimates. Electronic beamforming multibeam systems estimate the slant range to each echo event point based on the strength of the signal relative to a threshold. Electronic beamforming can be applied to either the transmit or receive cycles. To steer a transmit beam downward, multiple staves (elements) are sequenced with a slight delay. Each staff fires in sequence. The sum of the signals from each staff would then produce a wavelet in the desired direction. To steer a beam normal to the face (straight out), all staves would fire at the same time. In the case of a transmit beam formed system, each beam must be formed one at a time. The process of transmit beam steering is slow since each beam must be formed in sequence. A better solution (and the one used by most electronic beamforming systems) is to apply this "phasing" principle to the receive signals, as shown in Figure 6-3. The angular acoustic wave front strikes each receive element, but at a different time and phase depending on

the angle of the return. By introducing a variable delay to each receive element's information, the phases can be aligned and the beam can be 'steered' in the direction of the return. In order to accurately apply the correct delay, three factors have to be known or measured: (1) the physical distance between each receive element, (2) the time of reception at each receive element, and (3) the instantaneous speed of sound at the receiver face. (R2Sonic 2010).

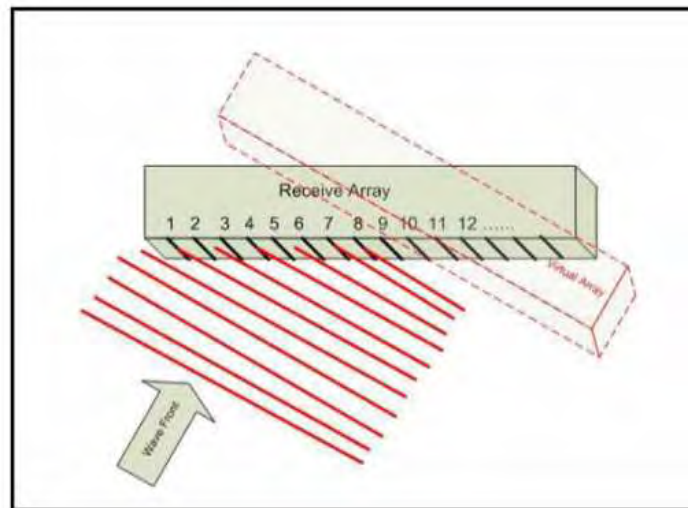

Figure 6-3. Electronic Beamforming. As the returning (reflected) wave progresses across the face, each receive element will see the wave at a slightly different time and thus a slightly different phase (R2Sonic 2010).

b. Interferometric systems (Phase Comparison). In interferometric multibeam systems, beam direction is determined by measuring differences in signal arrival times on an array of receive elements (phase differentiation). Interferometers provide range and bearing estimates to bottom depth points by detecting propagation delays from individual bottom spots to different transducer subsections. This is interpreted by the electronics as a phase difference in the signal. The phase difference is then converted to an angle or receive vector relative to perpendicular. Interferometry differs from the standard beam former in that the beams are created by a signal processor from data stored in the receive buffer. In interferometric systems, discrete beams are not physically formed--phase information from all directions are received and processed simultaneously. Interferometric techniques can provide high resolutions and a large number (hundreds) of beams within each ping array. The disadvantages of a purely interferometric multibeam echo sounder include: (1) phase tracking circuitry can become unstable and cause high data variations, (2) resolution depends on the internal detection rate (i.e., sophistication of the processing system), and (3) resolution and directivity near the nadir is poor.

c. Beam spacing. Beamforming multibeam systems are typically designed with between a 0.5 deg and 3.0 deg beam spacing. To increase resolution along the array, interferometric phase comparison techniques may be employed. The accuracy of a wide-swath multibeam is

determined by the ability of a multibeam system to resolve the actual beam angle in varying situations. A major component of this is correcting refractions due to sound velocity changes in the water column.

d. Beam footprint size. Outer beam quality and accuracy is dependent upon footprint size. As with single beam echo sounders, the smaller the beam angle, the better the system is able to discern true depth and resolve small features. As the size of the footprint increases toward the outer beams due to beam spreading, the stability and accuracy of the data decreases, resulting in a degradation of data quality and accuracy in the outer portions of the beam array. For this reason, angular restrictions are typically placed on the use of outer beam data; which limits the amount of single pass coverage in multibeam surveys.

e. Signal parameters. Each individual bottom spot within the ensonified swath responds with a reflected echo signal in which signal parameters (amplitude, frequency, phase) are all dependent. These parameters are dependent upon the characteristics of the bottom, namely (1) bottom reflectivity and (2) slope angle of incidence of the beam. Other local environmental factors that may need to be adjusted on a typical multibeam system include acoustic absorption, acoustic spreading loss, pulse length, transmit and receive power settings, and related time varied gain (TVG). Estimating these and other settings, and their impact on depth measurement accuracy (uncertainty), is often difficult. The quality of the return signal is also dependent upon the primary projector/receiver characteristics and the geometrical and acoustic reflective properties of the particular bottom material. A multibeam sonar's bottom detection thus provides three pieces of information: (1) the angle of the beam along which the acoustic pulse traveled, relative to the sonar head, (2) the round-trip travel time of the acoustic pulse, and (3) a signal intensity time series of the bottom return. These three pieces of information must be integrated with the other sensor data (e.g., vessel velocity, acceleration, roll, pitch, yaw, and heave motions) to determine the total sounding solution (i.e., X-Y-Z) relative to an earth-fixed coordinate system—e.g., the NSRS or local construction station-offset-depth reference framework.

f. Vessel positioning requirements. Both code-phase US Coast Guard DGPS and carrier-phase (RTK) GPS positioning methods are used to control the horizontal location of the vessel, and ultimately the multibeam transducer. Use of either positioning method depends on a number of project-specific requirements. In distant offshore coastal areas where tidal modeling is uncertain, carrier-phase RTK may be needed to enhance vertical accuracy of measured depths. When the multibeam is deployed horizontally to map underwater structures, RTK techniques may be needed to maintain decimeter-level horizontal accuracy. RTK is also recommended to obtain more reliable and consistent "Patch Test" calibrations.

g. Correcting vessel motion effects (heave, roll, pitch, and yaw). Multibeam accuracy is critically dependent upon the ability of the complete system to compensate for pointing errors caused by vessel heave, roll, pitch, and yaw. Various types of inertial and inertial-aided GPS methods are used to measure these motion parameters in real-time. Across-track location of each bottom point is critical. In wider swath systems, even a small degree of roll error can cause large errors in the outer beams. Vessel heave due to waves must also be accurately measured and

compensated for. These errors are further compounded due to beam spreading. Multibeam systems must be integrated with accurate motion reference units (MRUs) to correct for vessel motions. The inter-relationships between the positioning system, motion sensors, and the multibeam system, are critical. Quality control calibrations are essential to minimize errors due to these motion components.

h. Sound velocity and refraction. Since the array beams travel through varying water column temperatures and suspended materials (e.g., salinity) the refractive characteristics of each array beam must be determined and corrected. Thus, accurate sound velocity through the water column must be measured. Continuous (real-time) sound velocity measurements at the transducer head may be required on some systems.

i. Estimated accuracy. The propagated measurement uncertainties in depth measurements were described in Appendix D. Given the numerous parameters involved in a depth observation at various points along the array, estimating the resultant depth uncertainties is extremely difficult to quantify. Uncertainties tend to degrade away from nadir due to the velocity correction and signal processing methods described above. They can only be estimated from assumed uncertainties in the 40+ individual components that make up the overall uncertainty estimate. Many of these component estimates are, at best, educated guesses. Currently, the only practical method of estimating multibeam data quality is through Performance Tests that compare the multibeam data with more reliable near-nadir data from independent surveys—see details in Section VI in this chapter.

6-6. Overall System Requirements. Configuring an operational multibeam system requires the integration of various processors, sensors, and computers. In addition to the multibeam system itself (transducer and processor), the following primary peripheral devices are typically required on a complete system. All devices are linked through a computer with data acquisition and navigation software.

a. Positioning and navigation system. GPS (DGPS code or carrier phase). A survey Total Station may also be used for positioning in limited applications. Positional data is also fed to the vessel operator for real-time navigation.

b. Heading system. A gyrocompass is linked to the data acquisition computer, providing vessel azimuth orientation. (POS/MV systems may also provide this data.)

c. Motion compensation system. An inertial heave, pitch, and roll system provides real-time vessel motion data. Inertial-aided GPS systems (e.g., POS/MV) will provide this motion data.

d. Sound velocity probes. Sound velocities in the water column must be periodically measured. Some multibeam systems may require a real-time velocity probe at the transducer head.

e. Details on configuring, linking, interfacing, networking, and calibrating all these components are covered in manufacturer's operating manuals and software data acquisition manuals. Figure 6-4 depicts a typical configuration of the peripherals required for a complete multibeam survey system. The specific hardware and software shown is only for illustrative purposes—a variety of different (and equivalent) sources for these devices are available.

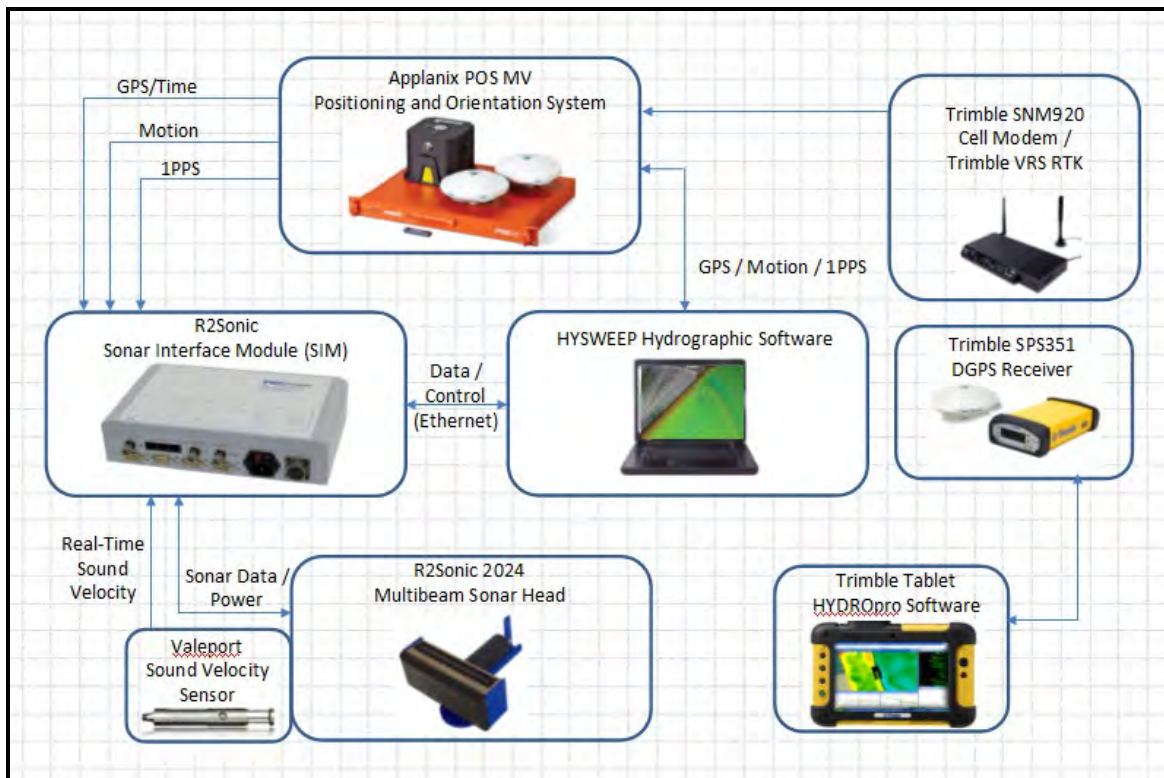

Figure 6-4. Typical configuration of a multibeam survey system. (Measutronics, Inc., Lakeland, FL)

6-7. References. The following references are recommended for more detailed descriptions of the operating principles of multibeam systems. They are also listed in Appendix A. Various manufacturers provide training courses that cover underwater acoustic theory and measurement principles relating to their specific multibeam system.

(1) “R2Sonic Broadband Multibeam Echosounders Operation Manual V3.0,” (R2Sonic 2010). Basic general underwater acoustic principles, amplitude and phase detection theory, especially broadband multibeam systems.

(2) “Multibeam Sonar Theory of Operation,” (L-3 SeaBeam 2000). Comprehensive multibeam signal processing techniques. Details various beamforming methods used in multibeam systems.

(3) “GeoSwath Product Information Bulletin,” (GeoAcoustics 2002). Covers acoustic propagation principles, transmit beamforming, receive beamforming, multiple receive arrays, and phase comparison principles, advantages, and limitations.

(4) “IHO Manual on Hydrography.” (IHO 2005). Details amplitude, phase detection, and interferometric techniques, including total propagated uncertainties of collected multibeam data.

SECTION II

Multibeam Applications and Utilization on USACE Civil Works Projects

6-8. General. Multibeam systems are primarily deployed on deep-draft navigation projects where full-bottom coverage is required. A typical example is a coastal navigation entrance project shown at Figure 6-5. Multibeam systems may also be employed on deeper portions of inland projects, and near USACE locks, dams, hydropower plants, reservoirs, river control structures, and revetments. Survey lines are normally run longitudinal with the channel or river alignment. The coverage of each swath is dependent on the depth and beam width. A typical 40- x 400-ft project can be covered with 3 to 5 lines, depending on the selected beam angle limits. (Refer to Section V in this chapter for estimating survey coverage). Vessel speeds are typically run slowly (e.g., 5 to 10 knots) in order to ensure 100% along-track ensonification, ensure multiple hits on potential hazards or shoals, or when collecting side scan imagery. At a nominal update rate of 40 profiles/sec in shallow water, and a 256 beam array, over 10,000 depths/elevations per second are generated; resulting in a large but densely detailed database for the subsequent processing and other engineering applications. Interferometric multibeam systems may obtain upwards of 50,000 depths per second. The tradeoffs to wide-swath, high-density data are increased editing and post processing time and the requirement for more sophisticated computer hardware.

6-9. Project Condition Surveys. Multibeam survey systems are primarily used for project condition surveys of USACE federal navigation channels, revetments, and other underwater structures where complete bottom coverage is desired to delineate the feature or structure. Multibeam sensors can be configured to detail coverage of pipelines, bulkheads, floodwalls, lock walls, revetments, breakwater riprap, and other similar underwater structures. Systems can be configured (or the transducer rotated) to provide up to 190-deg coverage, which would provide "water's-edge to waters-edge" coverage to both port and starboard. In some narrow projects, a single swath pass may provide full coverage.

6-10. Dredging Measurement and Payment Surveys. Multibeam survey systems that provide complete bottom coverage are recommended for use in most dredging measurement and payment surveys, i.e., plans and specifications surveys, pre-dredge surveys, post-dredge surveys, and final acceptance/clearance surveys.

a. Multibeam systems are an effective quality control process on dredging projects requiring 100% bottom coverage to assess and certify project clearance. The full digital terrain model (DTM) generated from a multibeam survey provides a more accurate and equitable (to the

government and contractor) payment quantity than that obtained from traditional single-beam cross-sections. However, the use of multibeam systems on dredging measurement, payment, and clearance work requires rigorous quality control and assurance calibration, and attention to

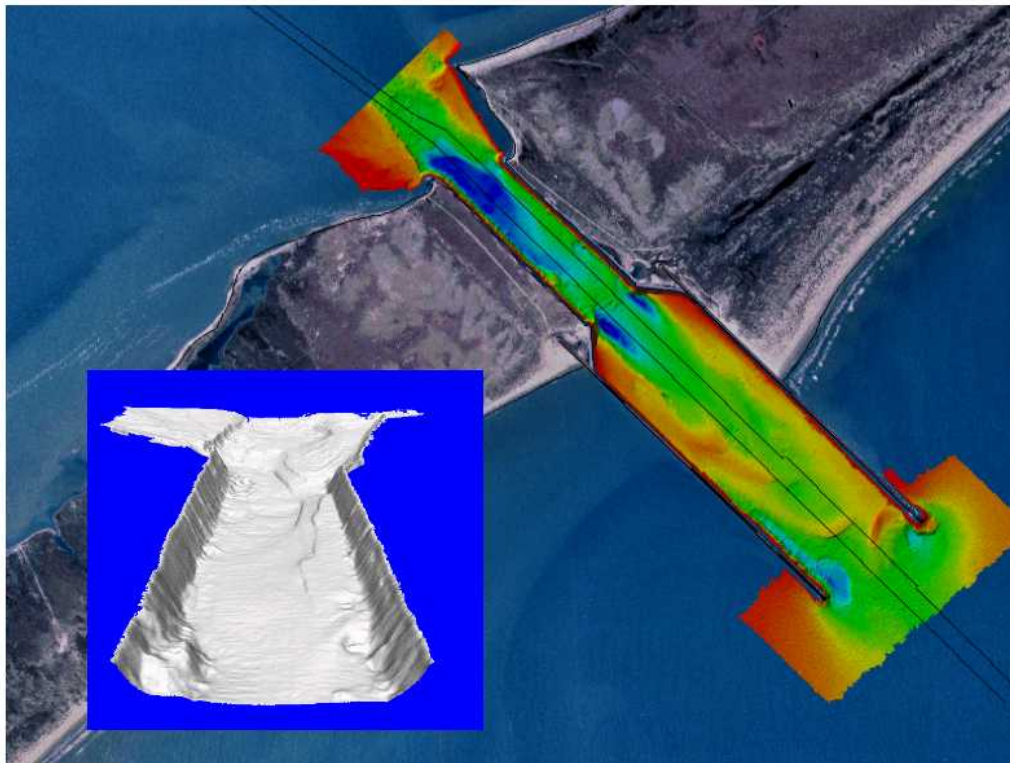

Figure 6-5. Full-coverage multibeam survey of coastal inlet navigation project and shore protection jetties. (Galveston District)

bottom type with respect to frequency. Any resultant biases that are not corrected can significantly affect volume computations. Multibeam systems are normally not used for payment or clearance on shallow-draft projects with sand or silt bottoms; however, less than 100% bottom coverage with multibeam may be acceptable in these shallow-draft projects.

b. Measurement and payment provisions in dredging contract specifications should clearly stipulate the type of multibeam survey system, acoustic frequency, navigation guidance system and software, data acquisition parameters (horizontal and vertical control, density, etc.), data processing and binning techniques, and mathematical volume computational method/software that will be employed by the government. In order to ensure consistency when performing measurement and payment surveys, commercially available software should be employed for data collection, data processing, data quality control, and volume computations.

6-11. Shoal or Strike Detection Applications. Multibeam survey systems represent an effective mechanism for detection of shoals, rocks, wrecks, debris, or other navigation hazards lying

above grade in a navigation channel. The side-looking aspects of both the multibeam signal and the digital backscatter sonar imagery signal may be used for such investigation purposes. In order to enhance the probability of detection, and depending on documented system performance characteristics, 200% bottom coverage may be specified in order to ensure objects are ensonified from two aspects--and to confirm at least three multiple hits are obtained on these objects. Performance demonstration tests on simulated objects should be periodically performed to assure data detection quality and assess the need for overlapping coverage.

a. Emergency operations. Multibeam systems recording both topographic data and digital side scan imagery are recommended for locating underwater objects and marking objects for clearing after natural disasters. New York District successfully deployed multibeam systems along with towed side scan sonar to locate a downed aircraft in the Hudson River.

b. Multiple-transducer, boom-mounted, channel sweep systems are generally preferred for use over multibeam survey systems in shallow-draft (<15 ft), sand/silt-bottomed navigation channels. (However, especially with the ability to tilt the sonar head, multibeam systems are also a valuable tool that can be used in these same projects.) Multi-transducer systems will also provide 100% bottom coverage on shallow draft navigation channels, as will mechanical, or manual, channel sweeping techniques. Mechanical bar sweeps still remain an effective dredging quality control technique when rock is encountered—see Chapter 10.

6-12. Underwater Structure Investigation Surveys. Multibeam systems represent an effective tool for performing detailed investigations of the conditions of Corps locks, dams, and other underwater structures, such as bridge piers, revetments, intake structures, spillways, breakwaters, jetties, and sheet pile bulkheads. Refer to Chapter 9 and Appendix N for details and examples of structure investigation surveys.

6-13. Multibeam Side Scan Imagery. Multibeam systems generate side scan imagery along with the basic depth information. Multibeam side scan imagery is generally not as good as towed side scan imagery (see Appendix Q). The high aspect of a hull mounted transducer results in high grazing angles. These high grazing angles result in small shadows. Off-nadir beam amplitude imagery degrades quickly because of the poor intensity of the returned acoustic energy and is subject to "false target generation" in side lobe interference situations. The larger the beam footprint, the coarser the amplitude imagery. Amplitude imagery is also called "backscatter intensity" and can be exploited for bottom classification (reference Geocoder processing algorithms in HYPACK 2011). Angle independent imagery, or time series imagery, provides an image very similar to towed, low resolution, side scan sonar. The resolution is much higher and the data rates are much higher. Multibeam data acquisition that includes the angle independent imagery results in very large data files.

6-14. Miscellaneous Considerations.

a. USACE personnel training requirements. Multibeam system operators require considerable expertise in both surveying and on CADD workstations. Prior to using multibeam

systems on USACE surveys, system operators should have completed specialized training. Presently, the Corps PROSPECT course on Hydrographic Surveying Techniques is not considered sufficient for multibeam training. Comprehensive training courses are available from: (1) the University of New Brunswick, (2) HYPACK, Inc., (3) University of New Hampshire-NOAA Joint Hydrographic Center, or (4) The Hydrographic Society of America seminars. Multibeam manufacturers also offer specialized training sessions.

b. Plant utilization and justification. Multibeam surveys may be obtained using either USACE hired-labor forces or through A-E service contracts. Commands considering procurement of multibeam systems should internally determine that such a system represents an effective and efficient utilization of floating plant, given the \$200 K to \$500 K investment for a complete survey-quality multibeam system with auxiliary sensors. Some factors that should be evaluated include: (1) proposed multibeam vessel, (2) system configuration (hardware and software), (3) estimated annual utilization (time and location), (4) FTE allocations, (4) system operator qualifications, (5) field data processing, editing, and plotting, and turnaround capabilities, (6) estimated daily plant and survey crew rental rate, and (7) comparative analyses between hired-labor and contract costs.

c. Calibration and quality control. Field quality control calibration of multibeam acoustic refractions and vessel motion is significantly more critical and complicated than that required for standard single beam systems. Recommended calibration requirements, procedures, and allowable tolerances are described in later sections of this chapter. Quality assurance Performance Tests are essential in order to assess and demonstrate data quality. These quality control calibrations and quality assurance Performance Tests must be processed and adjusted on board the survey vessel prior to and during the survey—after-the-fact checks in the district office are of little value if an uncorrectable field calibration problem is detected. This implies that near real-time field-finish data collection, processing, and editing must be established in the field in order to ensure the most cost-effective utilization of this technology.

SECTION III

Configuring Multibeam Transducers on Corps Floating Plant

6-15. General. Multibeam systems are mounted on a variety of Corps vessels, ranging from 22-ft up to 65-ft vessels. Numerous factors must be considered in selecting the type (and size) of vessel, mounting location, and projected utilization of a multibeam system. Districts procuring multibeam systems should consult other districts with operational systems as part of this decision process—especially districts with similar project conditions. Contacts with multibeam manufacturers and the USACE Marine Design Center in Philadelphia are also recommended. Some of these mounting design considerations are outlined below.

a. Vessel size. Multibeam systems are generally more cost-effectively utilized on small, mobile (trailerable) survey vessels up to 26 to 30 ft in length, with the transducer assembly externally mounted over the bow or either port and starboard sides. This allows the system to be

rapidly deployed on remote projects. Permanent or retractable transducer mountings on large, non-trailerable, 30- to 65-ft survey vessels are generally recommended in situations where such a vessel is primarily based near a major coastal navigation project.

b. Mounting stability. A sturdy transducer mounting is required to eliminate any vibration at the underwater transducer head. In addition, the location should afford a smooth laminar flow at the head.

c. Transducer orientation calibration. A fixed transducer (i.e., hull mounted) minimizes the need for periodically calibrating the orientation parameters (Patch Test). Retractable transducer mounts should be designed such that they rigidly snap into the same underwater location each time they are deployed.

d. Lever arm calibration. Ideally, a multibeam transducer should be located as close as possible to the vessel's center of rotation, and as near as possible to the GPS positioning system antenna and inertial measurement unit. This is rarely possible in practice, especially on smaller vessels. Minimizing these lever arm distances between the transducer, positioning, and inertial units helps reduce errors inherent in these parameters. Measurement of these lever arm distances requires precise survey measurements (± 1 cm). These measurements are often difficult when visual access to any of the units is blocked.

e. Maintenance. Access to the head allows removal of marine growth and ease of repair to the transducer elements if necessary. Retractable or pivoting mounting systems provide such access as opposed to fixed hull mounts.

f. Vessel maneuverability. The ability to retract the transducer from the water allows the vessel to reach project sites at full speed and without danger from hitting underwater obstructions.

g. The following sections provide additional guidance, advantages, disadvantages, and illustrations of various multibeam installations deployed by Corps districts.

6-16. Fixed Hull-Mounted Systems. Fixed hull-mounted systems are installed on large vessels, usually those exceeding 30 ft in length. A main advantage of fixed mountings is stability—orientation parameters remain relatively stable, minimizing the need for periodic calibration Patch Tests. A main disadvantage is maintenance; requiring that the vessel must be lifted into dry dock for access to the transducer housing. Another disadvantage is that the fixed transducer is vulnerable to being hit by any debris in the water. In the 1990s, a number of districts with 65-ft survey vessels elected to install fixed hull transducer mounts. Few such systems are currently deployed on newer large vessels in USACE—retractable transducers on split hull catamarans are now considered more effective. Figure 6-6 depicts a fixed-hull installation of the Reson 8101 system on the Norfolk District 65-ft Survey Vessel Adams II. This system was installed in 1998. This represented an effective fixed-hull installation since this vessel is deployed on nearby deep-water navigation projects in and around Norfolk and Chesapeake Bay.



Figure 6-6. RESON SeaBat 8101 fixed hull-mounted installation on Survey Vessel Adams II. (1998 Norfolk District)

6-17. Through-Hull Transducer Mountings. A number of districts (e.g., Mobile, Portland, Jacksonville) have recently elected to procure 50 to 65 ft split-hull catamaran vessels with a retractable transducer mounting between the hulls. This is sometimes referred to a "moon pool" mounting. The transducer mounting is located near the vessel's center of motion to minimize underway rotation corrections and lever arm distances to the peripheral positioning and inertial motion units. The transducer is hydraulically lowered to its fixed underwater position. The mountings have rigid locks such that the transducer head is always fixed at the same location; thus minimizing the need for periodic Patch Test recalibrations. Since the transducer can be easily retracted, the vessel can reach remote project sites at full speed. As indicated in Figures 6-7 and 6-8, the head can be easily accessed for maintenance.

6-18. Bow-Mounted Transducers. Retractable bow-mounted transducers are typically used on smaller, trailerable vessels, although they may be used on any length vessel. They are either physically (manually) or hydraulically deployed to their underwater position, with a rigid locking mechanism. A disadvantage is that vessel motion at the bow (e.g., pitch) can be large; and that lever arm distances to the positioning system and inertial motion system are lengthy. The following figures (9 through 12) illustrate bow-mounted transducer installations.



Figure 6-7. Portland District S/V Redlinger. The S/V Redlinger is a 60-ft foil supported catamaran. Survey equipment includes an Applanix POS/MV, Simrad EM 3002, and an Odom CV100. The transducer is located just aft of the cabin.

6-19. Side Mounted Transducers. Side-mounted transducers are commonly installed on smaller vessels, such as that shown in Figure 6-13. Installations may be permanent or temporary. As with bow-mounted installations, vessel motion (especially roll) may be significant on side mounts. Vessel pitch may be significant on systems mounted near the stern. Thus, lever arm and vessel motion measurements (corrections) are demanding and critical

a. 45-Ft Survey Launch Vollert, Galveston District. Figure 6-14 depicts the installation of an Odom multibeam system aboard the Survey Launch Vollert. The Vollert is a 45-ft length vessel with twin diesels, a 12-ft beam, and 3-foot draft. This vessel is normally used to conduct hydrographic surveys federal navigation projects in the Houston, Galveston, Texas City, and Freeport areas. The multibeam transducer shown is side-mounted on temporary rigs near the

EM 1110-2-1003
30 Nov 13

mid section of the vessel. The guys shown in the figure were used in attempts to reduce vibration down at the head—a more rigid frame near the waterline is required to fully stabilize a side-mounted transducer.



Figure 6-8. Louisville District 30-ft survey boat with through hull mounted transducer (Reson 8125-H multibeam system).



Figure 6-9. S/V Turpin with bow-mounted transducer.



Figure 6-10. Tulsa District retractable bow-mount. It is hydraulically deployed.

EM 1110-2-1003
30 Nov 13



Figure 6-11. Bow-mounted transducer on an inflatable raft. This portable vessel is used for US Geological Survey multibeam surveys of the Colorado River in the Grand Canyon. It is manually deployed.



Figure 6-12. Bow-mounted transducer with an optional rigid (locking) tilt capability to provide coverage up to water's edge on revetments or lock & dam structures. This rigid tilt lock minimizes the need for Patch Testing at this optional setting. (St. Louis District S/V Boyer)



Figure 6-13. Typical multibeam transducer systems side-mounted on a rigid pole attached to the survey vessel. (Odom, Inc. and GeoAcoustics, Inc.)



Figure 6-14. Side mounted multibeam transducer on S/V Vollert. (Galveston District)

b. Portable side mount. Figure 6-15 illustrates a compact, lightweight multibeam transducer side-mount on a small vessel. The mount is attached to the hull in two places.



Figure 6-15. Side/aft mount of an Odom ES-3 transducer and inertial motion sensor. Mounting the GPS antenna directly above the transducer and motion sensor minimizes lever arm measurements and corrections.

6-20. Stern-Mounted Multibeam Transducers. Multibeam transducers can be mounted on the side near the stern or on the stern itself, as shown in Figures 6-16 and 6-17. Such mounting

locations are often temporary—i.e., installed on a "vessel of opportunity" on a one-time project. Lever arm corrections and vessel motion measurements may be significant at these locations, and require demanding quality control and quality assurance testing.



Figure 6-16. New England District survey boat with aft/side mounted multibeam system. The GPS positioning antenna is located directly over the multibeam transducer.



Figure 6-17. Temporary stern-mounted multibeam transducer on a small skiff. In this case, engine propeller noise did not appear to affect the data quality. (Portland and St. Louis District)

SECTION IV

Quality Control Procedures for Multibeam Systems

This section provides recommended technical guidance for performing system alignments and quality control calibrations of multibeam sonar systems used on Corps projects.

6-21. Background. Many field calibration requirements for multibeam systems are similar to those required for single beam systems described in Chapter 4. However, some calibration and quality control procedures for multibeam systems are more critical and demanding than those required for single beam echo sounders. Periodic, precise calibration and verification testing is absolutely essential in order to assure multibeam derived elevations meet the prescribed accuracy tolerances for the project--especially near the outer beams of the array where refractive ray bending and vessel alignment and motion variations can significantly degrade the data quality. With improved resolution and increased beam coverage, there is a greater need for accurate sensors to ensure that the recorded depth is reduced to its correct position on the sea floor. This is accomplished by interfacing the multibeam system with position and attitude sensors, such as: (1) a high accuracy, geodetic quality GPS system (including heading and attitude RTK systems), (2) inertial motion reference units to monitor changes in position, velocity, acceleration, heave, pitch, and roll, and/or (3) a gyrocompass. In addition, the time synchronization for all these components is critical. For this reason, the system accuracy is comprised not only of the multibeam sonar accuracy but also the various components that make up the total system.

a. The components that make up a multibeam system must be periodically aligned, calibrated, tested, and monitored in order to ensure overall data quality. Quality control calibration tests are performed to measure alignment and timing biases in the transducer head, inertial measurement unit, gyrocompass, GPS antenna, etc. These calibrations are prescribed to minimize errors due to time latencies, roll, heave, pitch, and heading for the integrated suite of equipment.

b. Quality assurance Performance Tests on multibeam data (covered in Section VI) are periodically performed to determine if the quality control calibrations have been reliably performed, or need to be repeated. A Performance Test will provide a statistical estimate of the data accuracy (or "repeatability"). The test results should be checked against the statistical accuracy criteria prescribed for the particular type of survey.

c. Procedures for performing these calibration tests are outlined in this section and are more fully detailed in the hardware and software manuals provided with the individual sensors making up a multibeam survey system. These include acoustic refraction measurements (i.e., velocity casts and bar checks), system latency calibrations (time variances between positioning, depth, and motion sensors), vessel motion and heading sensor calibration (roll, pitch, yaw, and heave sensors), and various other vessel alignment and coordinate/datum corrections. Many of these calibration requirements are critical--failure to perform adequate calibration may render a

survey invalid. Since many of the alignment and offset parameters are interrelated, failures at one level of test may require recalibration and/or retesting prior levels. Some calibrations are performed during initial equipment installation on the vessel; however, others must be performed on a more frequent basis--especially when dredging measurement and payment surveys are involved. It should be strongly emphasized that the software and procedures for calibrating, processing, editing, and thinning multibeam data are still being refined and will undergo modifications as new systems are acquired and performance is validated.

6-22. Initial Installation Alignment and Static Offset Measurements. Alignment and offset parameters must be measured for the various sensors making up the multibeam system, e.g., MRU and gyroscope alignment/offsets, transducer mounting angles/offsets, GPS antenna offsets, static and dynamic drafts, vessel settlement/squat, and estimated latencies. These measurements are made upon initial installation or upon replacement, removal, and reinstallation of a sensor. Alignment and offset corrections are entered in the software system setup modules.

a. Static offsets of the sensors (Lever Arm measurements). These are the distances between the various sensors and a designated reference point on the vessel (Figure 6-18). This entails physical measurement on the vessel platform--locating the relative X-Y-Z coordinates of the multibeam transducer, GPS antenna(s), gyrocompass, MRU sensor, POS/MV system, etc. These measurements should be performed with the vessel stabilized on a trailer or on blocks where more exact, stable measurements can be made. A total station and/or tape are used to obtain the measurements. The sensors should be measured from a reference point in the vessel. (On cutter suction and excavator dredges, the origin should be established at the trunnion point). This point is typically the center of gravity or the intersection of the pitch and roll axis. The center of gravity will change with varying load conditions of the vessel and thus must be chosen to represent the typical conditions while surveying. On large stable vessels, the center of gravity will slightly change vertically along an axis that contains the center of buoyancy. On smaller vessels, the center of gravity and the center of buoyancy may not be exactly aligned due to eccentric loading. This condition is to be avoided as it also contributes to the instability of the vessel itself. This information can be obtained from the blueprints of the vessel. This reference point (now the coordinate system origin) should be a place which is easily accessible and from where measurements to the sensors will be made. The coordinate system should be aligned with the x-axis along the vessel keel (positive forward), the y-axis abeam the keel (positive to starboard), and the vertical (z-axis) positive down. The offsets of the sensors are measured from the reference point to the center of the sensor. The center of the sensor can be found in the manufacturer's schematic for the sensor, or can be accurately measured with a tape. It is common for the acoustic and physical centers of a multibeam transducer to be in different places. The magnitude and direction of the measurement should be verified and recorded.

b. MRU sensor. If possible, the inertial MRU sensor should be placed on the centerline of the vessel, as close as possible to the center of gravity or the intersection of the roll and pitch axes of the vessel. If the MRU is offset from the keel, it should be accurately aligned parallel to the keel. Mounting MRUs on bow or side mounts is not recommended due to potential heave correction issues. The x-axis of the MRU should ideally match the x-axis of the transducer;

however, this is not always feasible on over-the-side mounts. Azimuthal misalignment of the MRU will result in the depth measurement being in error proportional to the water depth. Misalignment of the MRU sensor in yaw causes a roll error when pitching, and a pitch error while rolling.

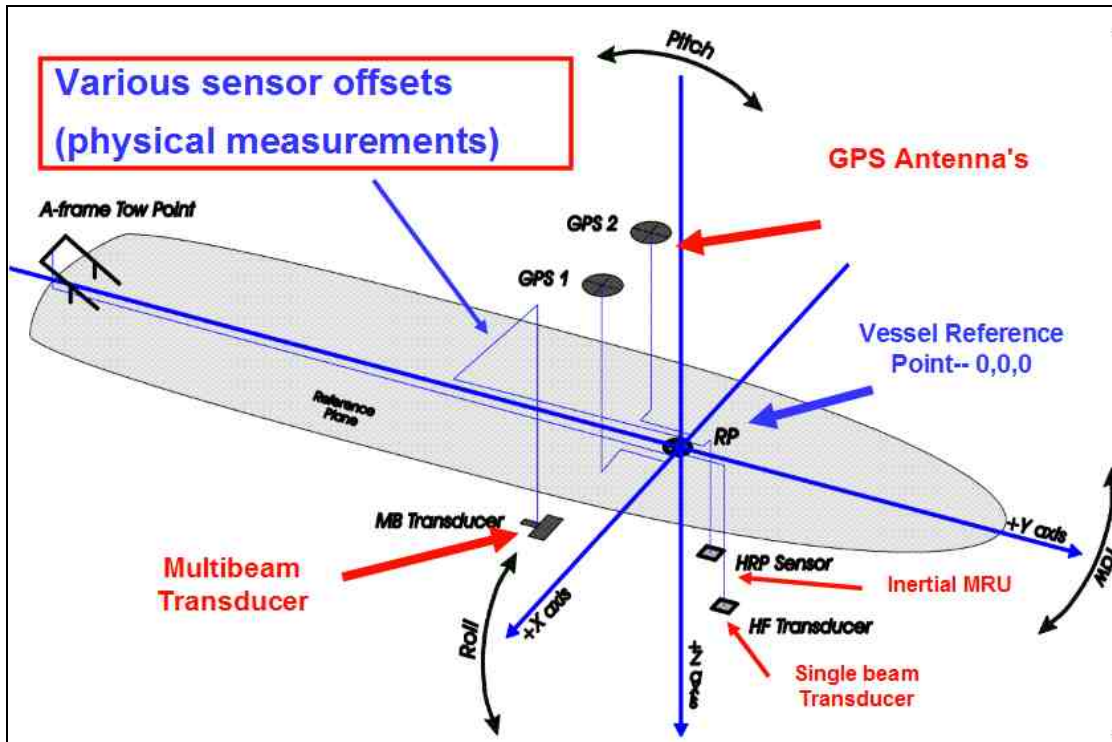

Figure 6-18. Lever arm offsets between various sensors on a survey vessel.

(1) MRU resolution. MRU system accuracy must far exceed the alignment resolutions of the orientation parameters in the vessel system. Thus, if the roll orientation has been calibrated by a Patch test and is believed accurate to ± 0.1 deg, then the MRU sensor should have an accuracy to better than, or at least, this same level of accuracy. Most higher-end MRUs can achieve these accuracies.

(2) References. Refer to the “IHO Manual on Hydrography,” (IHO 2005) for descriptions of the error magnitudes caused by roll, pitch, and yaw misalignments. If the transducer and MRU are collocated, many alignment corrections become far less critical.

c. Multibeam transducer. The multibeam transducer should ideally be installed as near as possible to the centerline of the vessel and level about the roll axis. However, in practice, the transducer is usually offset from the keel by varying amounts, and may be forward or aft of the center of gravity (e.g., side mounts, bow mounts, twin catamaran hull mounts, etc.). The transducer should also be precisely aligned with the azimuth of the vessel. The depth of the transducer head below the waterline of the vessel must also be determined. As in single beam

systems, bar checks are performed to measure static draft variations, which may include a constant index error that would not be detected if only a physical measurement were made. Likewise, squat/settlement tests are performed to calibrate dynamic vessel variations. Longer-term fuel loading draft variations must also be monitored.

(1) With the over-the-side types of transducer mounts, it is imperative that the azimuthal alignment between the transducer and keel be as close as possible. This can be accomplished with the vessel on a trailer or blocks. Since this side mounted technique allows for raising the transducer at the end of each day of operations and lowering it at the start of the next day's survey, this type of mount should be periodically checked for any alignment changes. The frequency with which it is checked will depend on what type of surveying is performed and under what conditions. Hull mounted or retractable transducers are generally fixed (or rigidly lock) in place and will not need to be checked as frequently.

(2) The fore-and-aft angle of the transducer mount must be evaluated. Since most vessels underway will be lower in the stern, the transducer will generally need to be rotated slightly aft to compensate for this angle. The Patch Test (pitch) will check for this transducer angle. The resulting beam should ideally project nearly normal to the sea floor while conducting surveying operations.

d. Gyroscope heading. The gyroscope should be aligned with the x-axis of the vessel using an electronic total station and geodetic control points. This can be done with the vessel on a trailer or secured tightly against a pier where there is minimal wave action. The gyro should be warmed up and, if necessary, the proper corrections for latitude applied. Locate two points on the centerline of the vessel and position a target on each of them. Observe the two targets with the total station and synchronize the readings with the gyro readings. Several readings will be needed for redundancy. Compute the vessel's azimuth and compare with the gyro readings. Compute the mean and standard deviation of the readings. If the offset is more than 1 deg at the 95% confidence level, realign the gyro with the centerline and repeat the observations. If less than 1 deg, apply the correction to the gyro output. The processing may take longer than with the total station. (Use of a dual antenna CodaOctopus F180/190 or Applanix POS/MV orientation systems eliminates the need for gyro azimuth control.)

e. Positioning time delay (Latency). Time delay in the positioning is the time lag between the time positioning data are received and the time the computed position reaches the logging module. This results in a negative along-track displacement of the depth measurements. While surveying at slow speeds, this displacement will be small. In general, the processing time for the position will vary with the number of observations used in the final GPS solution. If the time imbedded in the GPS message will be used, then you must ensure the correct synchronization between this time and the transducer or signal processing clock. A Patch Test (described below) is performed to determine a constant latency correction.

6-23. Vessel Squat/Settlement, Draft, and Datum Variations.

a. Squat/Settlement measurement. The combined squat and settlement of the vessel should be measured at several speeds and a look-up table produced for correcting the transducer draft. This measurement is essential since a MRU will not measure the long-term change in elevation. A MRU heave sensor will record the sudden change in elevation but the measured heave will drift back to zero. The settlement can be measured with a level on shore and a 2- m level rod or stadia board on the vessel positioned over the MRU sensor. The vessel should make several passes at various speeds in front of the shore station and the rod elevation recorded. The elevation difference at each speed is noted and used as the draft correction while surveying. Ensure that the correct sign is applied when entering the correction in the software. (Refer to Chapter 4 for details on performing these measurements.)

b. Squat/Settlement measurement using RTK. An alternate method for determining squat/settlement makes use of carrier-phase RTK elevation difference measurement. This method is also described in Chapter 4.

c. RTK water surface elevation determination. If precise RTK is being used as an absolute elevation reference correction for the multibeam transducer, then there is no requirement to enter in a squat/settlement correction. Likewise, tide/stage data and dynamic draft corrections may also be eliminated. However, if RTK is used only to determine the tide/stage level, then squat and draft measurements must be input to the processor.

d. Short term dynamic draft measurements. Changes in vessel draft due to fuel or loading changes should be monitored throughout the day, and depth corrections applied if trim variations are significant. These procedures are identical to those described for single beam surveys. Heave corrections output from RTK and/or MRU systems must be monitored to ensure long-term sea swells or vessel turns do not bias the data.

e. Reference datum checks. Vertical datum NSRS/NWLON referencing requirements and calibration methods are described in ER 1110-2-8160, Policies for Referencing Project Elevation Grades to Nationwide Vertical Datums, and EM 1110-2-6056, Standards and Procedures for Referencing Project Elevation Grades to Nationwide Vertical Datums. RTK water surface elevation measurements should be checked at a NSRS or NWLON based staff gage at minimum twice daily. Tolerances should be within the ± 0.1 -ft range. With current RTK and RTN networks, this represents more of a blunder check than a calibration. Such a check becomes more critical when a local RTK base station is used. Horizontal position checks should also be periodically performed at a known control point, if available. However, when using RTK, a quick comparison with a local code DGPS network is usually adequate for a horizontal blunder check.

6-24. Patch Test (Residual Bias Calibration). Patch Tests are periodically performed to quantify any residual biases in the initial alignment measurements of the sonar head, MRU, and/or gyroscope. The Patch Test is a series of reciprocal lines run at varying speeds, depths, and

bottom terrain in a small test area. It must be performed carefully and repeatedly to ensure that subsequent survey data collected is accurate and reliable. The Patch Test determines the vessel orientation alignment corrections for (1) positioning time delay or latency, (2) pitch, (3) roll, and (4) azimuth/yaw. The determined angular offsets and time delays will be used to correct the initial misalignments; thus, calibrating the sensor orientation system between each component and the vessel.

a. References. Detailed procedures for performing Patch Tests are covered in data collection software manuals, e.g., HYPACK and Caris. Multibeam system vendors also provide guidance on performing Patch Tests (e.g., see R2Sonic Operation Manual—R2Sonic 2010). Position and depth errors due to sensor and Patch Test calibration misalignments are detailed in Chapter 3 of the IHO Manual on Hydrography (IHO 2005). The procedures outlined below are extracted from these references. (Note that there are varying opinions among manufacturers regarding the sequencing of Patch Tests.)

b. Patch Test survey procedures. Reciprocal survey lines are run for each of the four Patch Test components, as shown in Figure 6-19.

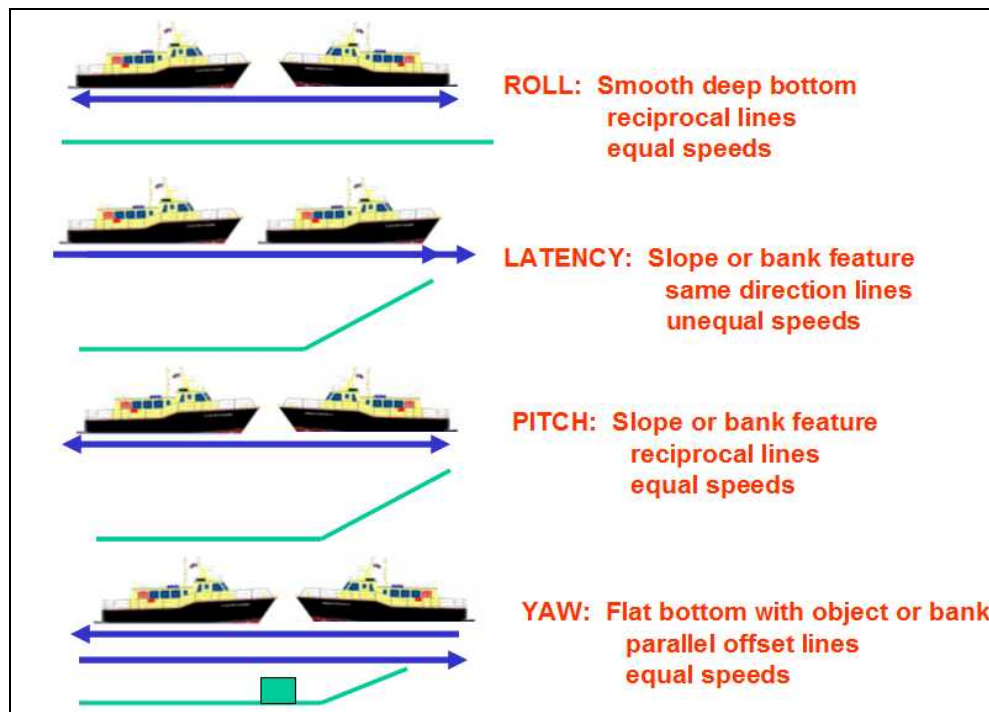

Figure 6-19. General overview of Patch Test runs. Refer to software operating manuals for details.

(1) Test site conditions. The weather and sea states should be calm to ensure good bottom detection and minimal vessel motions. Since most of the test lines to be run will be

reciprocal lines, it is important to have capable vessel steering and handling. Running on slack tides and slow currents is recommended. The lines should be run in deep water since the test results are less reliable in shallow water. The order in which the test lines are run is not important although it is recommended that at least two sets of reciprocal lines for each test be run for redundancy. Vessel speed should be regulated such that 50% forward overlap is obtained.

(2) Positioning. At minimum, survey quality code phase DGPS positioning must be used when conducting the Patch Tests. However, it is strongly recommended that carrier phase (RTK) positioning be used to perform these tests. This is because horizontal positioning accuracy has a significant impact on the repeatability of Patch Test results. For example, a 3-ft difference in DGPS positions during a test can cause a 0.4-sec latency variation and a 4-deg variation in pitch/yaw. Variations of this magnitude will not yield acceptable Patch Test calibration consistencies.

(3) Positioning time delay test and pitch bias test. Two pairs of reciprocal lines are run at different speeds to check for biases in both positioning time delay (latency) and pitch bias. Latency is determined from runs made over the same line in the same direction, but at differing speeds. (Both of these biases may exist simultaneously and must be discerned and separated during the test data processing.) These lines should be run in an area with a smooth, steep slope—10 deg to 20 deg, if possible. The slope should ideally be at least 200 m long in order to obtain good samples. A channel side slope may have to suffice if no other relief is available. At least two pairs of reciprocal lines should be run both up and down slope, at velocities differing by at least 5 knots to best assess the time delay. The greater the difference in velocity, the more accurate the test. Pitch is determined from the runs made over the same lines at the same speed in opposite directions.

(4) Roll bias test. In an area of flat topography, run at least one pair of reciprocal lines approximately 200 m in length to test for roll biases. Roll bias will best show up in deep water. Depending on the type of multibeam system, these lines should be run at a speed to ensure significant forward overlap of the beam's footprint. The beam width can be found in the manufacturer's specifications.

(5) Azimuth (Yaw) offset test. At least two adjacent parallel pairs of reciprocal lines shall be run normal to a prominent bathymetric feature such as a shoal or channel side slope, in shallow water. Do not use a feature with sharp edges such as wrecks since there is more ambiguity in the interpretation. The adjacent lines should have an overlap of about 15% and the feature should be wide enough to ensure adequate sampling. This width is generally greater than three swath widths. These lines should be run at a speed to ensure significant overlap of the beam forward footprint--use the same equation as that for roll bias.

c. Patch Test data processing and adjustment. Numerous survey software routines have been developed to automatically calculate system latency, roll, pitch, and yaw biases in

multibeam systems, using best-fit image matching techniques. The adjustment procedure outlined below uses the entire data set collected from the Patch Test lines with minimized thinning. Visualization of the data is important. In addition, the position and attitude data should be checked for errors, especially noting the time-tag errors. Cleaning of the bathymetry is usually not necessary since individual soundings will not be adjusted but rather clusters of data points will be analyzed.

(1) Processing sequence. The procedures to process the Patch Test data should be in this order: (1) latency, (2) roll, (3) pitch, and (4) yaw. Latency is processed first and the bias value entered into the software. Processing of the remaining three parameters is an iterative process, in that same order. This is due to the interrelationships between the parameters.

(2) Positioning time delay (latency) bias. This delay is computed by measuring the along-track displacement of soundings from the pair of coincident lines run at different speeds over the steep slope or other prominent topographic feature. Lines run in the same direction should be used to avoid the effect of pitch offset errors. The survey lines are processed, plotted, and compared while assuring that no corrections are made for positioning time delay, pitch error, roll error, and gyro. The time delay is then averaged by getting several measurements of the displacement in the along-track direction. This process is performed iteratively until the profiles and contours match or achieve a minimum difference. The latency bias is applied before the remaining biases are tested. This should actually be an average of biases from repeated latency tests. Note that latency biases are (should be) zero (0) when UTC time-tagged GPS positioning systems are used.

(3) Pitch offset bias. The pitch offset bias is determined from the two pairs of reciprocal lines run over a slope at two different speeds. The important characteristic of pitch offset is that the along-track displacement caused by pitch offset is proportional to water depth. Thus, the deeper the water the larger the offset. Pitch bias errors will impact both the depth and its position. The lines are processed while only applying the positioning time delay correction and the static offsets of the sensors. The pitch offset is then averaged by taking several measurements of the displacement in the along-track direction. This process is performed iteratively until the profiles and contours match or reach a minimum difference.

(4) Roll offset bias. Roll bias is computed using the pairs of reciprocal lines run over a flat, deep area. Generally, this offset is the most critical in deeper water and should be carefully measured. Roll errors directly induce errors in depth measurements, especially in the outer beams. The roll offset is averaged by several measurements of the across track displacement along the test swaths. This process is performed iteratively until the profiles and contours match or achieve a minimum difference.

(5) Azimuthal (Yaw) offset bias. Parallel lines run normal to a bathymetric feature will be used for the measurement of the azimuthal offset. Errors in azimuth alignment cause positional errors in the depth locations. One pair of adjacent lines run in opposite directions is

processed at a time to remove any potential roll offset. The azimuthal offset is averaged by several measurements of the displacement over the feature and knowing the across-track distance at the location of the measurements. This process is performed iteratively until the profiles and contours match or achieve a minimum difference.

d. Patch Test repeatability and resolution. Due to various positioning accuracies, MRU resolutions, poor feature recognition, shallow depths, terrain variations, etc., the numerical result from an image match on a Patch Test parameter can have a high uncertainty. For example, repeated Pitch and Yaw Tests may vary by ± 1 deg or more. Roll biases are usually more repeatable, typically at the 0.1-deg to 0.2-deg levels. Likewise, latency repeatability is usually at the 0.1 sec level. Therefore, Patch Tests must be performed over different conditions and times in order to arrive at an average, longer term, correction for each parameter. For example, if the average of 20-yaw bias tests are performed over a year's time is 3.1 deg, and the standard deviation of all these tests is ± 0.4 deg, the repeatability of the tests is only about a half degree. However, the "standard error of the mean" of the long-term (20-test) average is ± 0.1 deg. Thus, the long-term average yaw bias value of 3.1 deg has a confidence of about ± 0.1 deg. Its "resolution" or long-term "estimated accuracy" is to the nearest 0.1 deg. A minimum of 10, and preferably more, Patch Tests should be performed to obtain reliable average biases. A log of these repeated tests should be maintained on the vessel. Obviously, and changes or modifications to the sensors requires a restart of this accumulative averaging process.

e. Automated Patch Test. Figure 6-20 depicts screen displays of automated Patch Test residual bias computations in HYPACK. See the "HYPACK Hydrographic Survey Software User Manual," (HYPACK 2011) for additional details on running these calibration tests. The results are input directly into the real-time processing system. Additional examples of Patch Tests from Philadelphia District are shown in Appendix F.

f. Frequency of Patch Tests. Patch Tests are always required at the initial installation of a multibeam system on a vessel. After initial installation, or after any equipment modifications, more frequent Patch Tests should be performed to verify the consistency of the computed residual biases, and to establish a long-term averaging trend for each bias as discussed above. Depending on the stability of the transducer mount, and the consistency of long-term averages, subsequent tests may only need to be periodically performed. Specifying "periodically" is problematic. Fixed-hull and rigid retractable mounts in moon pools will usually be stable and the Patch Test residual biases are not as likely to vary. Thus, monthly or quarterly checks may be adequate. If repeated Patch Test bias results are not consistent, or Performance Test results are outside tolerances, then more frequent tests are recommended, along with determining the source of the inconsistencies. When a critical dredge measurement and payment survey is begun, a Patch Test is recommended, if only for the record. Patch Test results, as with all other survey calibration tests, should be recorded in a bound survey book maintained aboard the vessel.

6-25. Velocity Measurements. As in single beam systems, the velocity of sound in the water column must be accurately measured. However, in multibeam systems, velocity measurements

are significantly more critical due to the effects of refraction ("ray bending") in the outer beams (Figure 6-21). Changes in sound velocity throughout the water column require corrections to each beam in the array for refraction. In addition, many beamforming systems require continuous velocity measurements directly at the transducer head in order to steer the beams.

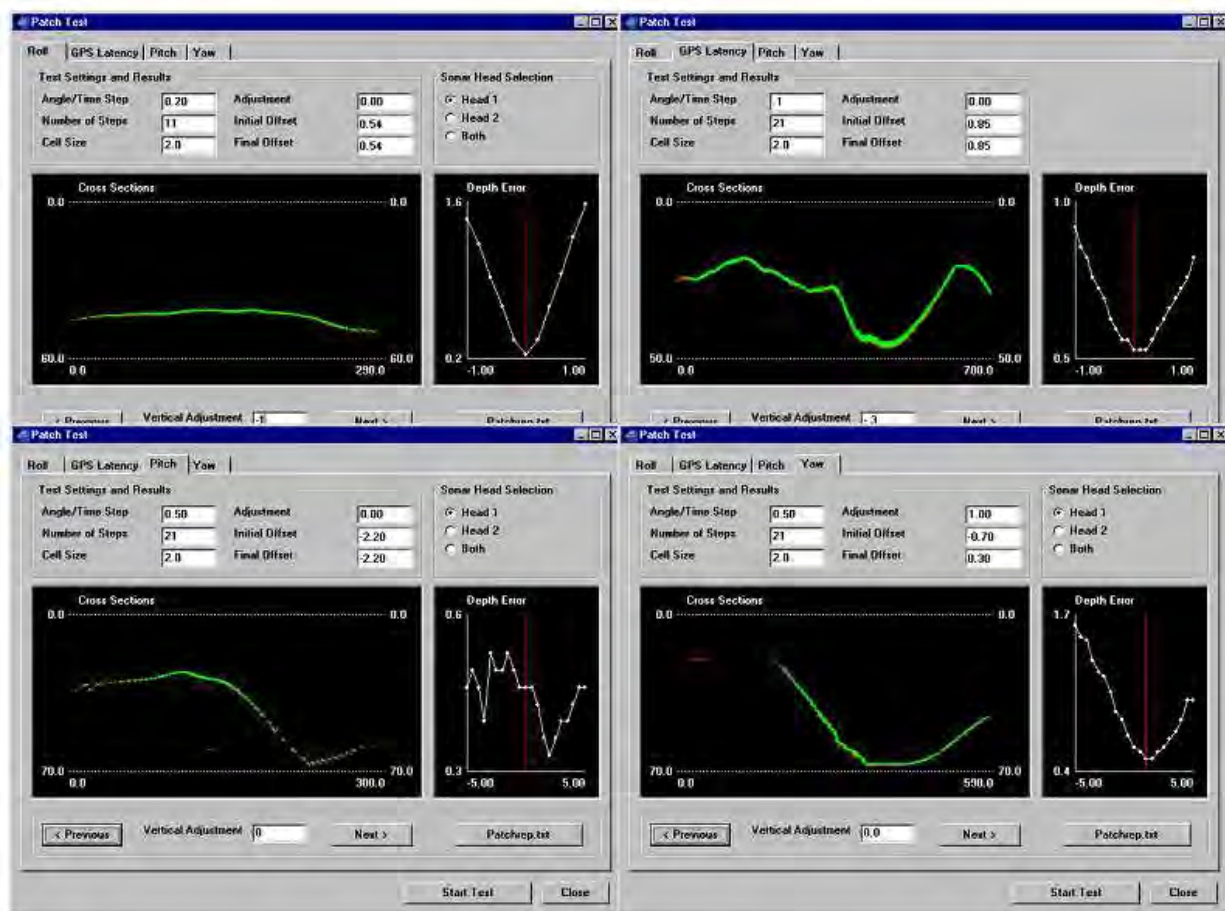

Figure 6-20. Automated Patch Test parameter computations--roll, latency, pitch, and yaw. Note that roll and latency tests on the top row provide the highest image matching resolutions. Pitch and yaw resolutions (bottom row) are typically coarser. (HYPACK, Inc.)

Since sound velocity in the water column can vary spatially and temporally, improper or inadequate determination of sound velocity corrections can often render multibeam data unusable. Velocity calibrations should be performed periodically during the day, no less than twice per day, and at more frequent intervals or locations if physical changes in the water column (e.g., temperature, salinity) are affecting data quality. This frequently occurs at coastal entrances or near power plant outfalls. In some areas, such as in Southwest Pass, LA, extreme salinity and temperature variations may require velocity observations every quarter-mile or closer (Figure 6-22). The quality of velocity data may be subsequently assessed through use of the "Performance Test" which compares overlapping survey data models. Beam angles should be reduced if

velocity data and/or Performance Tests indicate uncertainty (i.e., excessive repeatability or bias) in outer beam depth measurements. Velocity profile data is entered into the survey data acquisition system, typically in real-time during the survey.

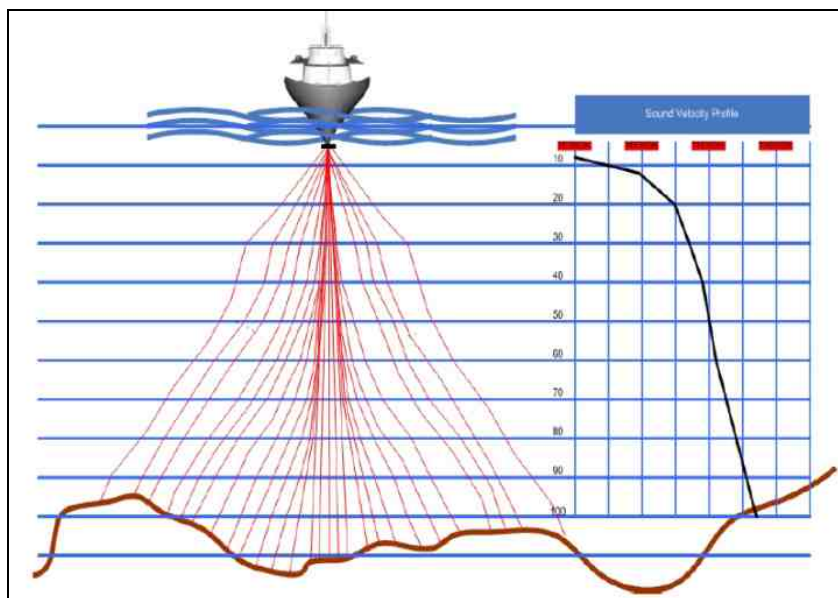

Figure 6-21. Outer beams are refracted due to varying sound velocities in the water column. These refractions on each beam must be corrected to obtain the location and depth at each point on the bottom. (R2Sonic)

6-26. Vessel Draft and Index Measurements (Bar Checks). As in single beam systems, a bar check represents the "reference quality control standard" by which multibeam echo soundings are ultimately calibrated. Upon initial installation, and periodically thereafter, a traditional bar check should be performed to calibrate the multibeam draft and index corrections and verify velocity corrections (from velocity meter casts) are accurate. The frequency of this calibration is a function of the repeated results, the stability of the system, and the nature of the survey. If periodic bar checks verify the draft/index corrections are holding constant, then less frequent checks are needed--perhaps every few months. Multibeam bar checks are performed similarly to single beam bar checks described in Chapter 4. It must be recognized that the acoustic reflectivity properties of a bar will differ from those of the bottom, which could inject a bias into the calibration. Some USACE districts have coated the check bar with foamed material in attempts to more nearly simulate bottom reflectivity conditions.

a. Nadir beam bar checks. Because of possible ray bending due to velocity changes, bar checks are typically performed under the center beams to quantify any draft or index errors in the system. As stated above, these need only be done on an infrequent basis, depending on the long-term stability of the results. This calibration is identical to that performed for single beam transducers. Figure 6-23 depicts a typical bar check over a portion of the multibeam array.

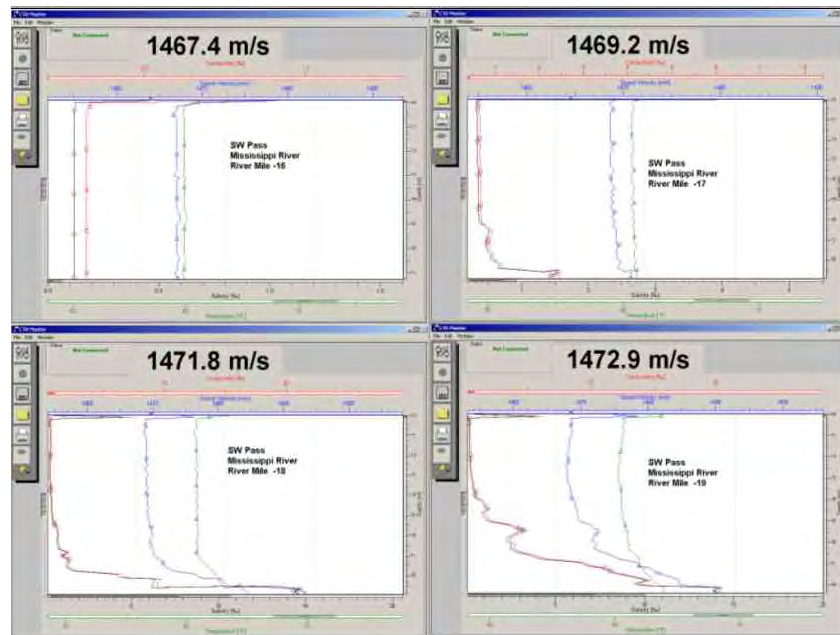

Figure 6-22. Typical conductivity/salinity, temperature, and depth (CTD) profiles at Southwest Pass, Mississippi River. Velocity profiles are shown to vary significantly over a relatively short distance (River Miles 16, 17, 18, and 19). (St. Louis District)

b. Outer beam bar/plate checks. The New York District has developed a quality assurance procedure whereby a small bar or single-line plate can be lowered from either side of the boat to perform a "blunder" or "confidence" check on the recorded multibeam data in the outer beams. Such a check can be quickly performed before or during each survey. Any portion of the multibeam array that is picked up can be used. Although not intended to definitively calibrate draft/index values like a bar check, this check will reveal gross biases. If biases exist between the plate/bar depth and the multibeam depth, then additional tests should be performed to determine the cause of the bias. It is recommended that this type of "blunder" check should be performed before each critical payment survey.

6-27. Beam Width Restrictions on Multibeam Systems. The coverage of multibeam systems is a function of swath width and water depth. Most systems provide coverage of two to approximately seven times the water depth. The number of individual beams (and footprint size) within the swath array varies with the multibeam manufacturer and operating principle. As outlined in previous paragraphs, the outer beams on each side of the swath are subject to more corrections and may not be useful for most dredging and navigation applications. The maximum angular extent of coverage must be verified, and accordingly restricted, by conducting some form of independent Performance Test. Thus, maximum allowable beam limits should be based on a Performance Test to verify the adequacy of the entire array. This beam array limit is typically determined from the HYPACK Performance Test software statistics, and is measured at the angular point where repeatability (bias) between the observed and reference data set exceeds

a prescribed tolerance for the project. Depending on various factors, primarily velocity and bottom reflectivity variations, it may be necessary to restrict beam widths to less than the measured limits in the Performance Test.

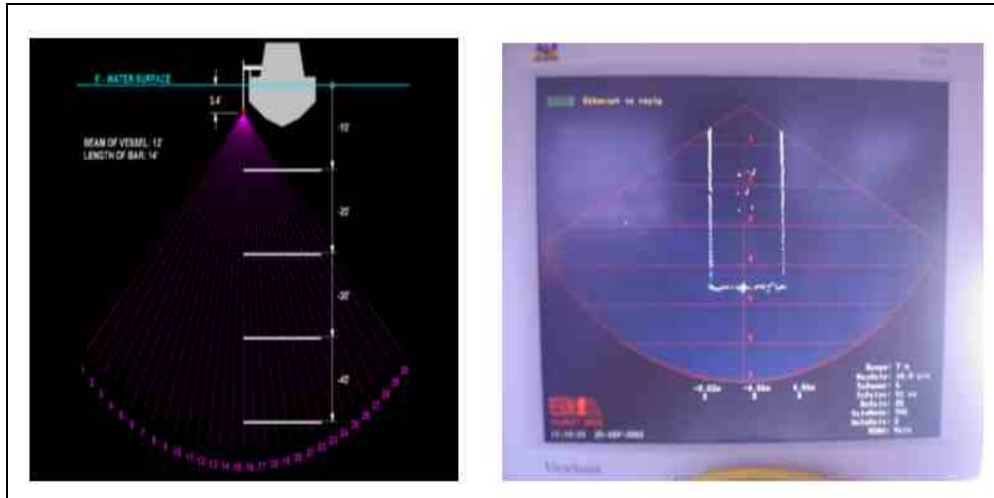

Figure 6-23. Bar check of a multibeam system. (Galveston District)

SECTION V

Multibeam Survey Data Collection, Editing, and Processing

Multibeam data are collected using commercial hydrographic survey software platforms, the most common in USACE being the HYPACK “SURVEY” software platform—see HYPACK 2011. Equipment configuration and line planning procedures are similar to those outlined for single beam surveys in Chapter 4. The main difference is that multibeam surveys may have more peripheral sensors to interface with the controller. This section provides a general overview of the collection and processing actions required for multibeam survey data.

6-28. Determining Coverage and Overlap. Most multibeam surveys are designed to obtain 100% bottom coverage (ensonification). Based simply on the project depth and beam array limit, a rough line spacing can be estimated. For example, with a 90 deg array in a 40-ft project, the line spacing is roughly 80 ft, not allowing for any off track steering. Using a nominal line spacing, survey coverage is performed by visually “painting the screen” or “mowing the grass” on a real-time screen display. The helmsman can then return back to fill in any gaps in the coverage.

a. Overlap. A survey line spacing may be computed to provide for a specified overlap between lines. This may help reduce gaps due to off track steering alignment. Alternatively, a line spacing it may be specified in order to obtain double acoustic coverage over the channel bottom. The multibeam line spacing ("L") and the number of longitudinal run lines ("N") for a typical navigation project can be computed using the methods shown in Figure 6-24. The depth

("d") is the average project depth. The sidelap ("s") should be set to the desired overlap between the parallel multibeam lines. Sidelap is intended to compensate for survey line steering limitations and/or duplicate coverage requirements. A 50% sidelap would provide duplicate (200%) bottom coverage if there were no steering misalignment. For a project condition survey where coverage is only required between the channel toes, a small sidelap allowance (e.g., 5 of 10 ft) may be made for vessel steering misalignment. As depth decreases up the side slopes, line spacing needs to be increased; however, only 100% coverage is normally required on side slopes.

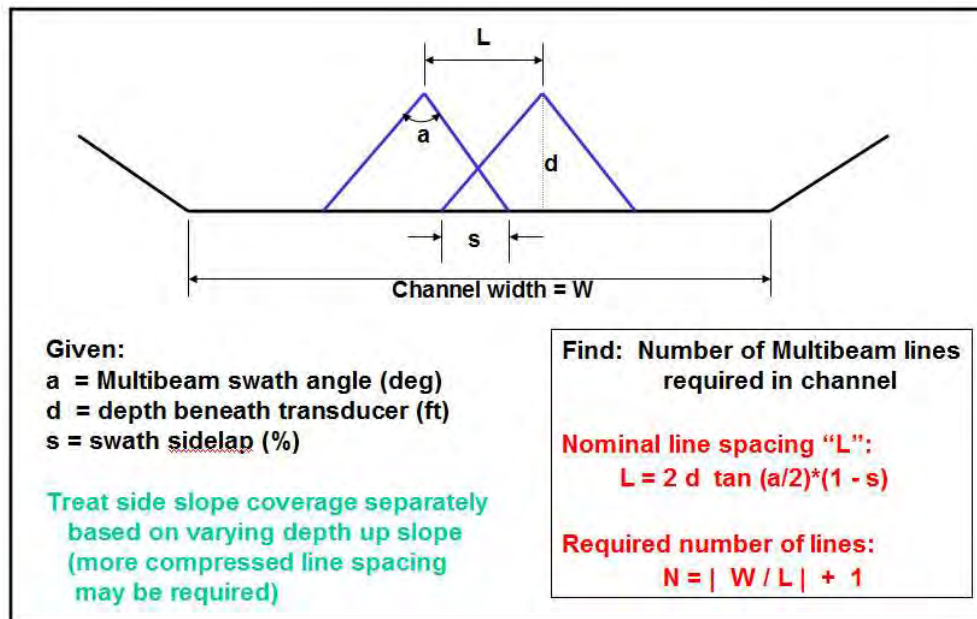

Figure 6-24. Computing multibeam line spacing on a navigation project given array width, project depth, and overlap requirements.

b. Example. The following examples illustrate line spacing computations for multibeam surveys:

Given: Project Condition Survey of 40- x 400-ft channel

(no coverage of side slopes required)

10% overlap between multibeam lines

a = 150-deg multibeam swath angle

d = 40-ft project depth

s = 10%

at 10% overlap, $s = [2d \tan (a/2)] \cdot 10\% = 30$ ft

Line Spacing: $L = 2d \tan (a/2) \cdot (1-s) = 2 \cdot 40 \cdot \tan (75 \text{ deg}) \cdot (1 - 0.1) = 269$ ft ... 270 ft

Number of lines: $N = | 400 / 270 | + 1 = 2$

Since the two lines easily cover the channel area, they would be spaced to provide overlap along the toes and with each other. If a 20-ft steering accuracy were assumed, then the two lines would

be run along channel offsets (+) 85 ft and (-) 85 ft from the centerline. The line spacing in this case would only be 170 ft, resulting in considerable overlapping coverage in the channel center plus a 20-ft tolerance outside the toes. Running offsets + 100 ft would be adequate for this coverage as well. If, in the above example, a more realistic 120 deg multibeam array were used, then the line spacing would be reduced as follows.

$$\text{Line Spacing: } L = 2d \tan (a/2) \cdot (1-s) = 2 \cdot 40 \cdot \tan (60 \text{ deg}) \cdot (1 - 0.1) = 125 \text{ ft}$$

The number of lines required to cover the channel between the toes is:

$$\text{Number of lines: } N = |400 / 125| + 1 = 3 + 1 = 4$$

If the multibeam array were restricted to 90 deg, as might be the case in a pre/post dredging survey, then the following line spacing would result for the same project:

$$\text{Line Spacing: } L = 2d \tan (a/2) \cdot (1-s) = 2 \cdot 40 \cdot \tan (45 \text{ deg}) \cdot (1 - 0.1) = 72 \text{ ft} \dots \text{ use } 75 \text{ ft}$$

The number of lines required to cover the channel between the toes is:

$$\text{Number of lines: } N = |400 / 75| + 1 = 5 + 1 = 6$$

If duplicate coverage were required for this project, the sidelap would be increased to 50%, resulting in the following line spacing:

$$\text{Line Spacing: } L = 2d \tan (a/2) \cdot (1-s) = 2 \cdot 40 \cdot \tan (45 \text{ deg}) \cdot (1 - 0.5) = 40 \text{ ft}$$

$$\text{Number of lines: } N = |400 / 40| + 1 = 10 + 1 = 11$$

The above computation is based on coverage between the channel toes. Additional lines may be required for side slope coverage. From the computed number of lines, an estimate of total lineal multibeam survey miles can be estimated. Given known survey speed, daily plant rental and crew rates, and mob/demob data, the time and cost to conduct the overall survey can be estimated.

6-29. Editing and Processing Multibeam Data. Collected multibeam data is processed and edited on a variety of commercial platforms and software packages. The most common platform used in the Corps is the HYPACK “HYSWEEP EDITOR.” This editor operates similarly to the single beam editor described in Chapter 4. Multibeam array depths are time-tagged with the positioning and motion sensors, corrected for water velocity, refraction, draft, lever arm, and dynamic draft variations. This section provides only a brief overview of the “HYSWEEP EDITOR” process—refer to the HYPACK software “User Manual” (HYPACK 2011) for details on editing and processing multibeam data.

a. The data flow through the “HYSWEEP EDITOR” is shown in Figure 6-25. Multibeam processing is done in three phases:

Phase I: Review and edit data collected from various sensors, such as inertial motion, DGPS, RTK, velocity, various constant sensor corrections, and vessel track lines for overlap.

Phase II: Perform detailed review and edit of each sensor and sweep depth data. Sweep data are reviewed section by section. Various filtering options are employed to speed up editing.

Phase III: Grid cell matrices (“bins”) are developed and a final review and edit is made. Output to user requested CADD or GIS format.

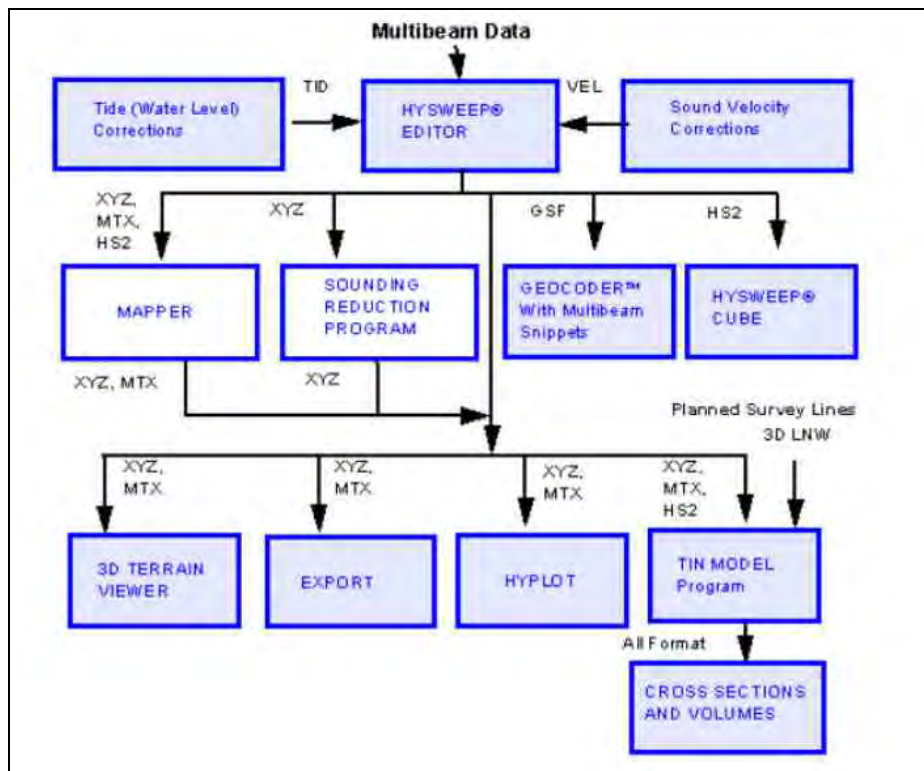

Figure 6-25. Multibeam data processing flow in HYPACK.

b. Generally, Phase I is performed aboard the survey vessel before the data are transmitted to the District Office. Phase II editing may be performed in the field or district office. Phase III is performed in the district office.

6-30. Editing and Filtering Data. Multibeam data typically contains many noise “spikes” that must be edited out of the database. Filtering and editing can be done in real-time, in post-

processing, or in combination. Manual spike editing can be performed by viewing each ping's cross-section and editing out spikes from individual beams—a labor intensive process given 40 cross-sections/sec may have been collected. More commonly, a block dataset is viewed in 3D form and data spikes are edited out manually in the 3D model. This is still a labor-intensive process. Automated spike or data anomaly filtering can also be performed. Such "intelligent" filtering is usually based on setting up maximum data quality or magnitude changes. During this automated filtering process, data can also be thinned if desired. Given the increasing densities of collected multibeam data, coupled with requirements for small bin sizes, smart use of automated filtering and editing has become a practical way to process these large datasets. However, these automated filtering and editing routines must be used with caution in that valid strikes above grade may be erroneously eliminated.

6-31. Thinning and Binning Multibeam Datasets. In theory, there is no need to reduce the size of the collected multibeam dataset. The entire "raw" database could be used for project or dredging condition assessment, volume computations, etc. However, these large datasets are thinned for a number of reasons, such as: (1) plotting in plan view without sounding overlap, (2) dredge volume computations, (3) channel clearance strike plots, (4) controlling channel depth reports, (5) 3D visualization models, or (6) simply to reduce the data down to a manageable storage size. There are a number of methods for reducing (or thinning) the size of large, edited multibeam datasets. For basic terrain visualization requirements (i.e. non-navigation uses), various thinning routines have been developed that can reduce datasets by 95% or more; typically selecting representative depths based on gradient changes over large areas. In current USACE practice, multibeam datasets are thinned into a fixed matrix or grid cell during the "Phase III" editing process. The size of the matrix cell is selected based on terrain irregularity, dredge volume computation requirements, or to prevent overplotting adjacent depths.

6-32. Recommended Bin Sizes and Depth Selection for USACE Navigation Surveys. The following paragraphs contain guidance on bin sizes and depth selection for all types of navigation surveys, to include: dredging measurement and payment surveys, dredge clearance/acceptance surveys, plans and specifications surveys, project condition surveys, and other related navigation surveys. This guidance is based on over 10 years of collective multibeam data processing experience by the districts within the North Atlantic Division. Designated bin sizes for a project should be included in dredging contract specifications. These same criteria are also applicable to multiple transducer sweep systems.

a. Recommended maximum bin size. For new work deepening projects, a maximum 3-ft x 3-ft cell size is recommended. On critical projects (e.g., rock) a 1-ft x 1-ft cell size may be used. For maintenance dredging of soft material, a maximum 5-ft x 5-ft cell size is recommended. Evenly spaced grid matrices should be generated over the full dataset relative to an established (fixed) origin point to ensure that different organizations (or software) processing the same edited dataset will obtain identical results--e.g., dredged quantities.

b. Other civil works surveys. There is no specified maximum bin size or depth selection method for other types of non-navigation surveys. Bin sizes may be varied depending on the

type of bottom or purpose of the project (e.g., beach sand transport studies, hydraulic studies) or final plan plot scale. In smooth, flat areas, bin sizes may be expanded to any level that will adequately depict the terrain. Bin sizes as small as 1-ft sq may be used for applications where maximum detail is required--e.g., underwater structure surveys or Performance Test Reference Surfaces. Instead of binning, more efficient data thinning methods may be used to generate a TIN model for 3D analysis.

6-33. Depth Selection Options from Binned Multibeam Data. Each bin (or cell) will likely contain multiple depths, depending on the density of the multibeam data and the number of overlapping passes made over the area. It is not uncommon for a 3- x 3-ft cell to have 50 or more depths if multiple passes were made over a suspected shoal area. Thus, an established method is needed to represent the depth within this bin. Presently, common selection options include: (1) a shot depth nearest to the bin center, (2) an average depth (placed at bin center), (3) a median depth, or (4) a minimum depth. CUBE depth selection options may also be considered.

a. Dredge measurement and payment surveys. The average or median depth within a bin is recommended for dredge payment surveys. These representative depths are subsequently used in TIN volume computations.

b. General plan drawings. The shot depth nearest the cell center is recommended to be shown as the representative depth on plan drawings, including those used for plans and specifications or project condition reports. Obviously additional thinning will be required to plot 3- x 3-ft bin depth data on a 1 in = 100-ft plan—only every 8 or 10 bin depths could be displayed at this scale.

c. Minimum depths. Minimum depths may be selected for channel condition reports, shoal or strike detection, or some dredge clearance purposes. Special caution must be exercised in using minimum depths in that the dataset will be significantly biased.

d. Figure 6-26 is an example of the representative depth options that can be selected from binned multibeam data on a navigation project. This guidance is also applicable to other bin sizes than those indicated. Additional guidance on depth selection options is covered in Chapter 2.

SECTION VI

Quality Assurance Performance Tests on Multibeam Systems

6-34. General. A Performance Test is used to evaluate the quality and confidence of multibeam data being collected. This test typically compares overlapping data sets from two different multibeam surveys--performed either by the same vessel or by different vessels. This test may also be performed by comparing multibeam data with that collected by another single beam or multiple transducer echo sounder--obtained by either the same vessel or different vessels. Other

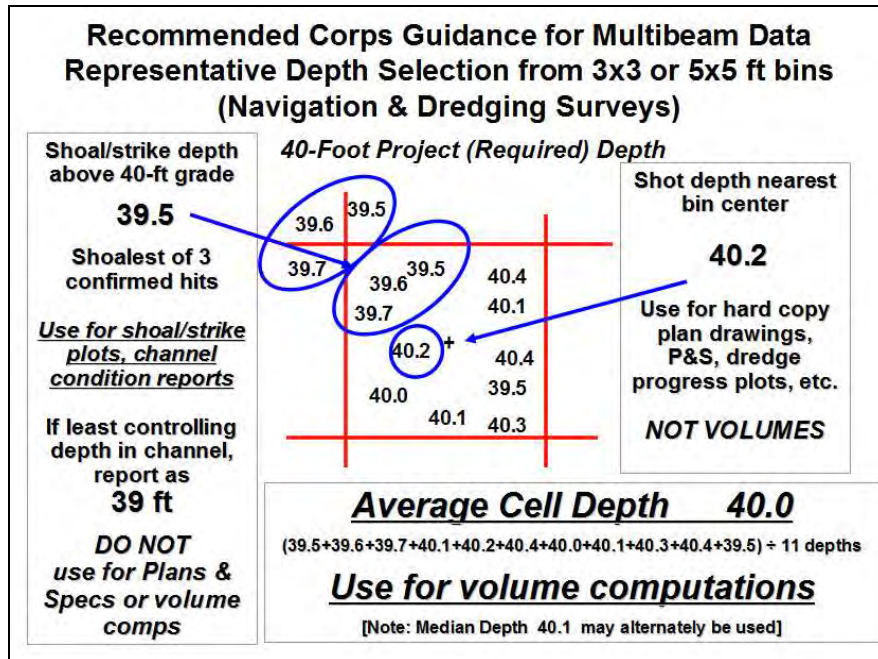

Figure 6-26. Representative depth selection options from binned multibeam data on a navigation project. This guidance is applicable to all cell sizes. The 39 ft reported controlling depth (CCR) was truncated to the nearest whole foot from the observed 39.5-ft shoal depth. In deeper draft projects with higher depth measurement uncertainty (e.g., standard deviations approaching ± 1 ft), truncating, rather than rounding, is recommended.

comparison test methods are also used, such as matching multibeam bathymetry of a flooded Corps lock chamber against topographic data measured in the same lock chamber during a dewatered state. Object detection capabilities may also be verified by sweeping over simulated objects of known size; placed either in open water or in controlled lock chambers.

a. Purpose. The purpose of a Performance Test is to obtain an estimate of the accuracy (and, most importantly, repeatability) of a multibeam system dataset. These accuracy estimates can then be compared with defined accuracy standards for a particular type of survey, such as those recommended in Chapter 3. This test also partially checks the parameters and biases that were measured and computed during the previously described quality control calibrations (velocity profile calibrations, Patch Test bias parameters, etc). If performed over different tidal phases, it may also detect poor tidal modeling in the survey area. This is especially critical if RTK surface elevation methods are not being used.

b. Frequency of Performance Tests. Performance Tests should be conducted before a dredging measurement and payment survey project; however, they are not necessarily needed prior to individual surveys in that project. In high cost per cy rock cut channels, daily or twice-

daily Performance Tests are recommended. (See Appendix F for New York District's mandatory QC and QA procedures on critical rock cut navigation projects.) For non-navigation surveys, Performance Tests may be conducted weekly, monthly, quarterly, or less frequently, depending on the long-term stability of the results, known variations in different project areas, etc. Performance Tests should also be conducted upon equipment installation or modification. Performance Test data reduction, processing, and statistical analysis should be performed in near real-time--i.e., on board the survey boat.

c. Undetected biases. Performance Tests conducted by the same vessel, the same multibeam system, and over a short tidal time period, are not truly independent but are only an assessment indicator--a constant bias in the system could go undetected. A more truly independent Performance Test is obtained when comparison surveys are run at different tidal phases, using different multibeam and single beam systems, by different vessels, in different locations, and differing sea state conditions. Such a test provides an estimate of "reproducibility" as opposed to "repeatability." New York and Philadelphia Districts have established fixed Performance Test sites where all their survey vessels have run repeated single beam and multibeam surveys. A composite of all these surveys has developed a "baseline" reference surface to which all subsequent tests are compared. However, this type of ideal test is not always practical if surveys are performed over wide geographical ranges. Typically, a Performance Test is done by a single vessel at the project site, comparing single beam and/or multibeam data from the same vessel. In this case, the test more properly indicates a level of "repeatability" in the data—see Chapter 3. Some of the biases that may not be detected when the same vessel and multibeam/single beam system is used in a Performance Test include:

(1) Squat/settlement bias. A constant error in the squat/settlement correction for the vessel will be undetected since the same vessel speed is run for all tests. Running different speeds might detect this error; however, it is probably small for most vessels. Use of RTK minimizes this potential bias.

(2) Draft errors due to undetected loading variations (dynamic draft). Use of RTK minimizes this potential bias.

(3) Tide/stage modeling errors (non-RTK control). When the comparison test is performed at the same time (tidal phase), errors in the tidal model will not be detected. However, performing the test at the same time will indicate the multibeam system is outputting quality data, independent of any tidal modeling errors. Performing the comparison tests at both the same and different tidal phases is strongly recommended, in that the independent quality of the multibeam system can be checked separately from any biases in the tidal model. As detailed in EM 1110-2-6056, errors in the tidal model can represent the major portion of an error budget for an individual depth measurement, and can easily mask the errors in the multibeam system. If Performance Test biases are small (< 0.05 ft) when run at the same tide phase, and large when tested over different times/phases, then a tidal modeling problem is indicated. No amount of multibeam QC calibration or QA performance testing will rectify this modeling error--the only

practical solutions are to correct the tidal model or utilize RTK direct elevation solutions, which also requires appropriate geoidal and tidal modeling corrections.

(4) Bottom reflectivity. Like single beam systems, multibeam systems can have varying biases due to bottom reflectivity and/or signal processing. These biases can be large, and may vary with beam angle and the signal processing method. They may vary geographically when seabed materials differ from place to place. In soft bottoms (unconsolidated sediments or fluff), multibeam depth measurements may be problematic and possibly unreliable. A constant depth error due to signal processing or bottom reflectivity biases is difficult to detect or calibrate. The most reliable Performance Test is to compare different acoustic systems over the same project area (e.g., different boats, multibeam versus single beam, different frequency systems, etc.).

(5) Given the above, obtaining an absolute (unbiased) Performance Test (“confidence test”) on a multibeam system is not a simple task. When the same vessel (and survey system) is used for all USACE measurement and payment surveys on a project, the Performance Test procedures recommended herein will yield a good estimate of the data repeatability and confidence, and indirectly the accuracy of any pay yardage derived from a survey. This presumes any undetected biases are constant (and hopefully small) for both pre and post dredge surveys. To better check for any undetected biases, Performance Tests should be run against different survey vessels and acoustic systems.

6-35. Performance Test Procedures. The following paragraphs outline the Performance Test methods found in HYPACK software. Specific details are found in the HYPACK Operating Manual (HYPACK 2011).

a. Reference Surface and Check Line surface development. The procedure described below compares a "check line" multibeam dataset with a "reference surface" dataset compiled from narrowly spaced multibeam data using only near-center beam data. The "reference surface" derived from independent vertical single beam data could also have been used, provided a reasonably dense single beam model is obtained. Failure of the Performance Test survey to meet the recommended tolerances requires corrective action--i.e., re-measurement, recalibration, patch testing, etc.

(1) Reference Surface (Figure 6-27). This is essentially a small survey run over an extremely flat area (less than 1 ft gradient) in water depths of not more than 100 ft. A flat bottom area minimizes the effect of positional errors on the test. It represents the "baseline" area. The bottom soil properties should be similar to the actual project. Performing the tests at slack tides will help minimize tidal biases. Four or five parallel lines are run with at least 150% bottom overlap--i.e., 25% sidelap. The line spacing must be close enough to ensure that the inner beams overlap enough to give redundant data. The beams outside a 45- to 60-deg swath width should be removed prior to editing. After these lines are run, four or five parallel lines are run perpendicular to the previously run lines with the same swath and overlap. The speed over the ground should be the same on both sets of lines. A velocity cast should be made in this area and the corrections applied. All the edited data in the Reference Surface are then binned at 1-ft x

1-ft cell sizes. The data in each cell are then thinned using the average depth of all the depths in a cell.

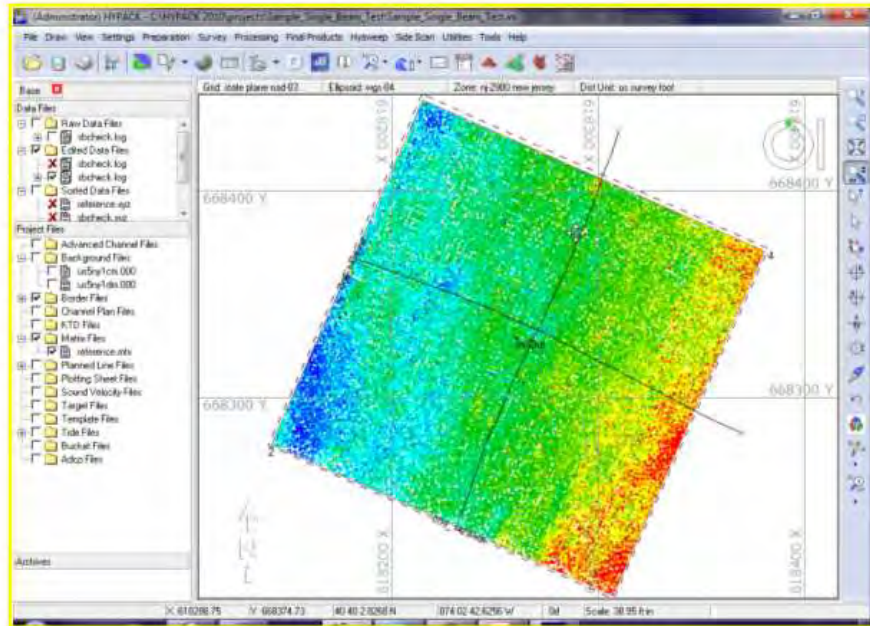

Figure 6-27. Color-coded Reference Surface binned into 1-ft x 1-ft cells. Multibeam line sets were run in each direction and restricted to less than ± 45 deg (HYPACK, Inc.)

(2) Check lines. Multibeam "Check Lines" will be run such that the full beam array can be tested against the Reference Surface. At least two perpendicular multibeam swath lines should be run inside the reference surface. The vessel speed is the same as for the reference surface. Ideally, a more independent test is obtained when the Check Lines are additionally surveyed at a different time and tidal phase from that of the Reference Surface survey; however, this is not always feasible in practice. (Another alternative is to run single beam Check Lines-- either from the same vessel or another vessel-- to compare with the multibeam Reference Surface.) The beam width of the Check Lines is not restricted so that the data quality in the outer parts of the array can be assessed. A difference surface between the Reference Surface and the Check Line surface can also be created and statistics computed to assess overall performance.

b. Data processing and analysis. Performance Test data processing and analysis should include assessment of the following statistical parameters.

(1) Outliers. Depth differences between the Check Line surface and Reference Surface are computed at each beam point along the Check Line array (Figure 6-28). Excessive outliers in the dataset should be edited out during processing.

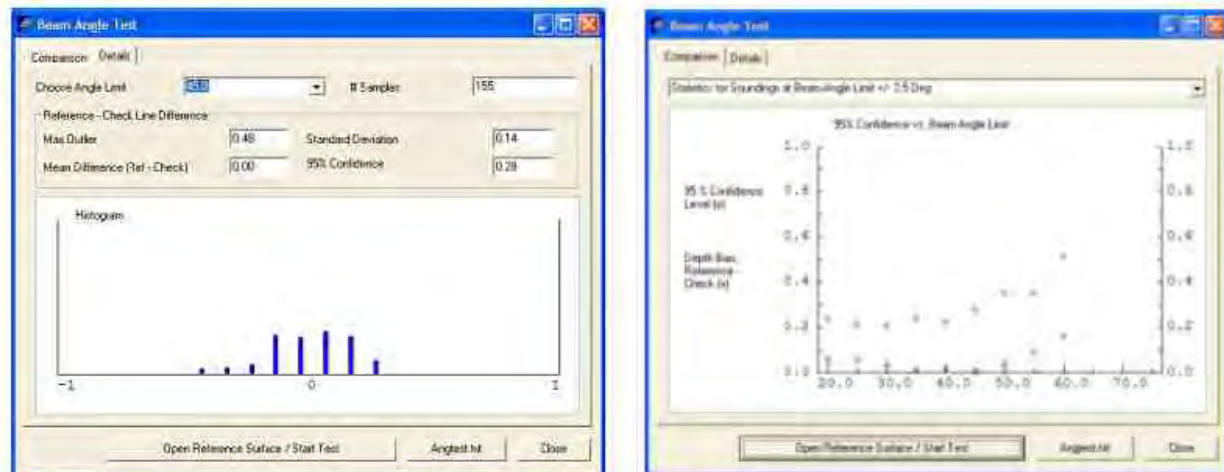

Figure 6-28. Statistical results of a Performance Test. Histogram on left shows dispersions and outliers in the Check Line beam angle set to ± 45 deg. No significant bias was present at the 45 deg beam angle. The test on the right indicates that biases between the Reference and Check data surfaces are less 0.05 ft out to 50 deg from nadir. Note that the "standard deviation" and "confidence" statistics are not independent when the same vessel performs the test, and that they have no relationship to the overall survey accuracy. (HYPACK, Inc.)

(2) Mean difference or bias. The difference, or bias, between the Reference and Check surfaces should not exceed the maximum allowable tolerances specified for the type of survey. This is the most critical quality assurance check on the data in that a bias error (i.e., lack of repeatability) will adversely skew depths and related quantity computations. Excessive bias errors require immediate assessment and correction. They could indicate problems with the multibeam data (e.g., MRU alignment) or vertical tide/stage corrections. Given thousands of comparative data points on multibeam surveys, any biases between the Reference Surface and the Check Surface should be small; typically well less than 0.05 ft. The example test in Figure 6-28 shows biases computed at various beam angle widths. This type of plot may be used to determine the maximum beam width that should reliably be used—in this example, array beam width would likely be restricted to ± 50 deg from nadir.

(3) Standard deviation and confidence. The standard deviation between the Reference and Check surfaces in Figure 6-28 is output as a one-sigma standard deviation. The standard deviation is simply converted to the "95% confidence" level by multiplying it by 1.96. (This example is not a confidence statistic that is usually based on the standard deviation of the mean statistic.) The existence of excessive outliers and biases will increase the overall standard deviation. Restriction of the beam array angle may reduce this error if most of the excessive outliers are in the outermost portion of the array. Results from this test may be used as an indicator of overall accuracy performance; however, these "95% confidence" statistics should not be confused with the estimated Total Propagated Uncertainty (TPU) of the depths since undetected biases may still be present in the data. Therefore, the nature of these statistics must be considered before setting any maximum limits on Performance Test standard deviations (or

confidences)—keeping in mind the difference between standard deviation and TPU—see Chapter 3.

c. Full-channel Performance Tests. Rather than use a small Reference Area described above, Performance Tests can be conducted over the entire project area, for example, a 3,000-ft acceptance section. Such tests may be multibeam v multibeam or multibeam v single beam. Surveys from different vessels may be tested over the project area. Surface models for each survey are tested against one another for biases and deviations. No survey will be considered the "Reference." Thus, determining which survey contains a bias will be difficult. However, if the statistics prove to be within allowable tolerances (Chapter 3), confidence in either survey (or vessel) will be high.

6-36. Multibeam versus Single Beam Performance Tests. Single beam versus multibeam comparisons are performed similarly to the previously described multibeam versus multibeam tests. The only difference is the Reference Surface is made up of tightly run single beam sections, e.g., 50-ft C/C over the 200-ft x 200-ft test area. Alternatively, the actual navigation project can be tested against single beam cross-sections run every 500 ft to 1,000 ft. These Performance Tests are more independent than comparing the same multibeam system against itself, as described above. This is due to each system having different signal processing methods, gain and sensitivity controls, etc. The single beam and multibeam sounders are typically on the same vessel; however, comparisons to another vessel's single beam system will provide an even more independent comparison.

6-37. Real-time Quality Assurance Tests. This simply involves operator assessment of data quality as it is being collected, making visual observations of cross-track swaths (i.e., noting convex, concave, or skewed returns in flat, smooth bottoms), data quality flags/alarms from the GPS, RTK, or MRU systems, or noting comparisons between adjacent overlapping swaths or between independent single beams. Real-time software must have features that allow some form(s) of real-time quality assurance assessment, and performing immediate corrective actions.

6-38. Sample Performance Test—Survey Vessel Shuman (Philadelphia District). The Performance Test results shown below were done over a very flat anchorage area with depth variation of less than ± 2 ft over a 200- x 200-ft test area. A reference surface was created by running two sets of four parallel lines, with line sets perpendicular to each other. The line spacing was approximate water depth (45 ft). After editing and application of tide and sound velocity corrections, the reference survey was gridded into 2- x 2-ft cells. The average of each cell (approximately 17 points per cell) was saved to an XYZ file. The results from comparison of the reference surface with two check lines (one in each direction) are shown in Table 6-2. This report was generated by the Beam Angle Test section of HYPACK/HYSWEEP multibeam processing program. (Additional Performance Test examples are shown in Appendix F.) The results of the above sample Performance Test indicate the multibeam system is providing reliable data out to a ± 75 -deg beam width. However, the relatively large constant biases of + 0.1 ft between the two surveys might be questioned and further evaluated as to the cause. If this test

EM 1110-2-1003
30 Nov 13

had been performed for a payment survey on a rock cut project, then these large biases should have been investigated.

Table 6-2. S/V Shuman Performance Test results.

Beam Angle Limit	Max Outlier	Mean Difference
20	0.37	0.11
25	0.37	0.11
30	0.37	0.11
35	0.40	0.11
40	0.40	0.10
45	0.40	0.10
50	0.40	0.10
55	0.45	0.10
60	0.88	0.10
65	0.88	0.10
70	0.88	0.10
75	0.88	0.11

6-39. Fixed Calibration Barge (Louisville District). Figure 6-29 depicts a sunken barge on the Ohio River used to verify performance on Louisville District multibeam systems. This "reference surface" is in 40 ft of water. Star test patterns are run over the barge.

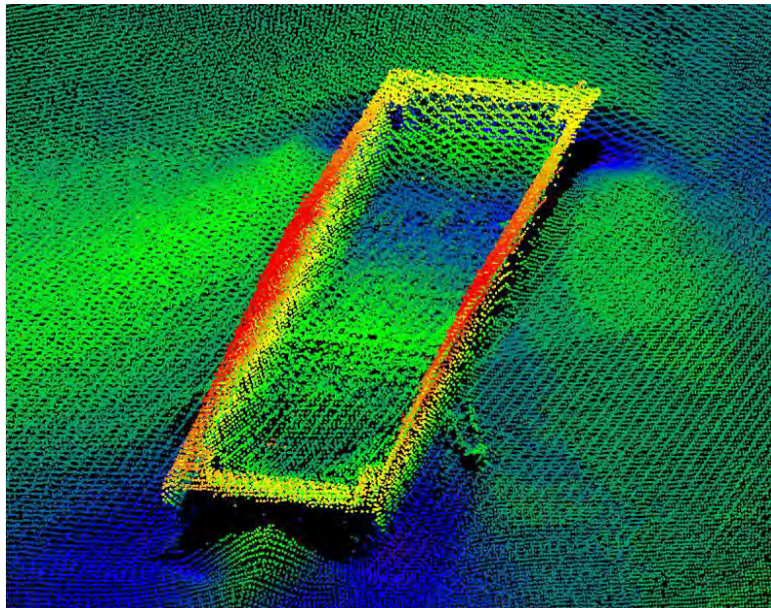

Figure 6-29. Louisville District calibration barge used as reference surface.

SECTION VII

Summary of Multibeam QC and QA Criteria.

Table 6-3. Recommended Quality Control and Quality Assurance Performance Criteria for Multibeam Surveys. (Refer also to Appendix F for additional guidance.)

Requirement	Recommended Frequency or Comment
Bar Check Calibration	Perform periodically (e.g., monthly or quarterly) recommended at start of new dredging project
Sound Velocity Calibration	Twice daily minimum, or more often in varying conditions (continuous velocity recording on some multibeam systems)
Horizontal Position Check	Daily on dredging projects (RTK v Code DGPS adequate)
Vertical Elevation Check (RTK)	Twice daily calibration at tide/staff gage.
System Alignment/Orientation Tests (e.g., Latency/Patch Test)	Perform periodically (e.g., quarterly) or as required. Recommended at start of new dredging project.
Vessel Squat/Settlement Test	Annually
Vertical Datum Verification	Refer to EM 1110-2-6056 for periodic requirements to ensure coastal tidal datums are consistent with NOAA reference datums; including periodic checks of tide/staff gages
Survey Coverage (Density)	100% coverage is recommended for maintenance dredging projects. 200% coverage is recommended for deep-draft projects with critical under keel clearances over rock.
Quality Assurance Performance Test	Periodically or as required based on project requirements. Recommended daily on critical dredging/clearance projects.
Object or Shoal Detection: Minimum object size	3 ft cube (periodically verify by independent detection test)
Minimum number of acoustic hits to confirm a shoal or strike above grade.	3 acoustic hits recommended. (successive passes over object)

EM 1110-2-1003
30 Nov 13

THIS PAGE INTENTIONALLY LEFT BLANK

CHAPTER 7

GPS Vessel Positioning, Orientation, and Water Surface Elevation Measurement

7-1. Purpose. This chapter provides guidance on the use of GPS satellite positioning to control hydrographic surveys of USACE navigation and other civil works projects.

7-2. Scope. This chapter covers GPS horizontal positioning and vertical elevation measurement methods. Both code phase Differential GPS (DGPS) and carrier phase Real Time Kinematic (RTK) positioning methods are covered, with an emphasis on RTK techniques to measure water surface elevations. Vessel motion reference units (MRU) and inertial-aided GPS vessel orientation and alignment measurements are also discussed. Given the rapidly evolving technological improvements in GNSS and MRU applications, the guidance in this chapter will be superseded in a relatively short time. Therefore, the focus is on quality control procedures for these systems which will not significantly change over time. Recommended quality control calibration techniques for these systems are provided in Table 7-1.

7-3. Required References. Various USACE and commercial publications cover the theory and principles of GPS surveying, including the operational set up and interfacing of GPS positioning systems with hydrographic survey data collection systems. To avoid duplication, this chapter references these other publications where applicable. The following primary references are required in conjunction with this chapter and are frequently cited.

a. EM 1110-1-1003 (NAVSTAR Global Positioning System Surveying). This manual covers GPS theory of operation, errors and accuracy, autonomous and differential positioning techniques, static and real-time kinematic (RTK) survey methods, and GPS survey adjustment techniques. Although the primary focus is on terrestrial geodetic and topographic surveying, the same principles apply to dynamic hydrographic applications covered in this chapter. Therefore, many of the basic principles of GPS positioning will not be repeated in this chapter.

b. EM 1110-2-6056 (Standards and Procedures for Referencing Project Elevation Grades to Nationwide Vertical Datums). This manual details methods for assuring GPS elevation measurements are properly referenced to project datums. Chapter 4 details procedures for referencing RTK surface elevation measurements to local navigation and construction datums.

c. HYPACK 2011 (HYPACK Hydrographic Survey Software User Manual). This user manual covers the hardware device and driver set up, and field survey operation of various hydrographic survey systems linked to (and time synchronized by) GPS positioning systems. These include various acoustic systems, motion sensors, inertial-aided GPS systems, and RTK water surface elevation measurement procedures.

d. POS/MV 2011 (POS/MV V5 Installation and Operation Guide). This guide covers

installation and operating details on an inertial-aided GPS positioning and orientation system for all

EM 1110-2-1003

30 Nov 13

high accuracy hydrographic surveying operations.

7-4. GPS Background and Applications in USACE. The GPS has become the standard surveying and navigation mode for most dredging and construction operations in USACE. Since the mid-1990s, GPS has largely replaced the terrestrial hydrographic positioning systems described in attached Appendix G ("Terrestrial (Non-GPS) Positioning Methods"). GPS is a form of a GNSS (Global Navigation Satellite System). A GNSS may refer to GLONASS (Russia), Galileo (European Union), etc. GPS manufacturers are developing receivers capable of tracking satellites in multiple GNSS systems. For the purpose of this manual, the term GPS is used. Autonomous GPS coverage (i.e., non-differential, general vehicle, vessel, or cell phone navigation) is worldwide; however, its 5- to 10+- m accuracy is inadequate for most USACE survey applications. (Future developments in autonomous positioning are expected to provide accuracies below the decimeter level.) Currently, most USACE hydrographic survey and dredging applications use code phase differential GPS (DGPS) positioning. The approximately 2-meter level horizontal accuracy from DGPS systems is generally adequate for dredge and survey vessel location. Numerous public and private DGPS networks now exist, allowing for nationwide and worldwide coverage. On more critical projects, especially in areas where water level tide or stage is uncertain, carrier phase GPS measurements (i.e., RTK) are becoming more common in USACE; and in the future will likely replace code DGPS methods. Like code phase DGPS, many public and private RTK networks (i.e., Real Time Networks—RTN) now exist throughout CONUS and OCONUS, enabling 0.1 ft X-Y-Z measurement resolutions.

a. Real-time code phase DGPS was first implemented in USACE in 1990 by the USACE Engineering Topographic Laboratory (ETL), now the AGC. These early systems consisted of two receivers—one as a base station over a known point and the other a “rover” aboard the survey vessel. In time, public and private DGPS networks evolved, providing DGPS without the need for a user-provided base station.

b. In the mid-1990s, the ETL (AGC) first implemented real-time carrier phase vessel positioning in USACE districts—i.e., RTK. This allowed for accurate (0.1 ft with appropriate filters) measurement of the water surface elevations in areas remote from gages, effectively minimizing the heretofore large uncertainties due to uncertain tidal models. In 1997-8, the first permanent USACE real-time RTK network was established by ETL at the St. Marys River entrance to the U.S. Navy Base at Kings Bay, GA. This single station Real Time Network (RTN) has been in continuous operation since 1998 by the Jacksonville District. See attached Appendix H for additional details on this project.

c. These code DGPS and RTK positioning techniques originally developed and implemented by ETL (AGC) have revolutionized the positioning techniques used aboard USACE survey vessels, dredges, and other mobile platforms. GPS has provided for more accurate payment surveys; and thus reducing disputes and claims, especially those arising from errors in water surface elevation measurements.

7-5. GPS Accuracies. GPS is simply a 3-D trilateration measurement—distances (ranges) are measured from the space-based satellites to the user's receiver. The positional accuracies obtainable from GPS are dependent on the satellite range measurement technique used, e.g., code or carrier. The estimated range accuracies, when coupled with the geometrical relationships of the satellites

during the position determination (i.e., dilution of precision-DOP, or geometrical dilution of precision-GDOP), results in a three-dimensional confidence ellipsoid that depicts uncertainties in all three planes. Given the changing satellite geometry and other factors, GPS accuracy is time/location dependent. GPS accuracy is also a function of interferences on the GPS signal, and the processing techniques used to reduce or remove these errors. Given that GPS signals travel from 20,000 km out in space through various atmospheric layers, these effects can impact the signal and the range measurement accuracy, and ambiguity phase resolution in RTK observations. Multipath effects at the base or rover receiver will also impact positioning accuracy. See EM 1110-1-1003 for a complete discussion on GPS errors and their sources. Error propagation techniques are used to define nominal accuracy statistics for the GPS user. These error estimates are often available in real-time from most GPS receivers.

7-6. Reference Datums.

a. Horizontal reference datum. Engineering, construction, and dredging surveys must be referenced to local project datums. The GPS system is based on the World Geodetic System of 1984 (WGS84). This geocentric coordinate system can be easily transformed to any type of local project reference datum (e.g., NAD27, NAD83, local project SPCS grid, and/or dredging construction station-offset reference system). Hydrographic survey software and data collectors can perform these coordinate transformations in real-time. Refer to EM 1110-1-1003 for details on GPS reference datums and transformations to user grids.

b. Vertical reference datums. Observed GPS (RTK) ellipsoid heights must be referenced to the local project vertical datum. Geoid models, tidal datum models (e.g., VDatum), and river stage models are needed to transform observed GPS ellipsoid heights to project elevations (depths). See EM 1110-2-6506 for guidance on developing and modeling vertical reference systems on Corps projects.

SECTION I

Code Phase Differential GPS Positioning

7-7. Real-Time Code Phase DGPS. Code phase tracking differential GPS systems are currently the most commonly used method for positioning hydrographic survey vessels and dredges. These systems typically provide positional accuracies around the 2-m level. They are not suitable for determining water surface elevations. A real-time DGPS positioning system includes a reference station (master or base), communications link, and a user (remote/rover) receiver. In the early 1990s, districts set up and operated reference (base) stations at each project. This is no longer required as there are several federal and commercial DGPS services that provide real-time

pseudo-range corrections. Only in rare circumstances (e.g., OCONUS) would local code phase DGPS system be required.

a. Reference station. The reference station measures timing and ranging information broadcast by the satellites and then computes and formats pseudo-range corrections for broadcast to

EM 1110-2-1003

30 Nov 13

the user equipment. The reference station consists of a GPS receiver, antenna, and processor. Using differential pseudo-ranging procedures, the position of a survey vessel is found relative to the reference station.

b. Communications link. The communications link is used as a transfer media for the differential corrections. The type of communications system is dependent on the federal or commercial DGPS provider' system. Some commercial DGPS providers utilize satellite communications to transmit correction data.

c. User receiver. The user receiver should be, at minimum, a multichannel single frequency (L1) C/A code GPS receiver. The receiver must be able to accept the differential corrections from the communications link and apply those corrections to the measured pseudo-range. The receiver must also have suitable update rates capable of maintaining positional tolerances for survey speeds up to 10 knots. The receiver must not bias the position during vessel turns due to excessive filtering.

d. Separation distances. The maximum station separation between a reference and remote station should generally not exceed 150 to 200 miles. This range can be extended on some commercial systems that model and adjust the tropospheric and ionospheric corrections. Unmodeled tropospheric and ionospheric errors can average of 0.7 m per every 100 km.

e. Satellite geometry. In code phase DGPS, the Horizontal Dilution of Precision (HDOP) is the critical geometrical component. The HDOP should generally be < 5 for dredging and navigation hydrographic surveys. The current GPS (and expanded GNSS) constellation should maintain a HDOP of approximately 2 to 3 most of the time.

7-8. USCG Code Phase DGPS Radiobeacon Navigation Service. In CONUS, and in some OCONUS locations (e.g., Hawaii, Puerto Rico, Alaska), real-time DGPS correctors may be obtained from the USCG radiobeacon navigation service. This section focuses on the USCG radiobeacon system since it is most widely employed in USACE; however, a number of commercial augmentation systems are capable of providing comparable survey positioning capability. Calibration guidance is applicable to all these augmentation systems.

a. USCG Maritime DGPS Service. Utilizing DGPS and marine radiobeacon technology, the USCG has implemented a real-time code positioning system for CONUS and OCONUS coverage. The USCG has also partnered with USACE and other government agencies to expand this coverage to the inland waterway navigation systems. The system consists of a series of GPS reference stations with known coordinate values based on the NAD83 datum. GPS C/A-code pseudo-range corrections are computed based on these known coordinate values and transmitted via a marine radiobeacon. A user with a marine radiobeacon receiver and a GPS receiver with the ability to accept and apply pseudo-range corrections can generally obtain a relative accuracy of around 2 m. This accuracy is dependent on many factors, including the design and quality of the user's GPS receiver, distance from the reference station, local weather conditions, and the satellite geometry.

b. Coverage. The system was designed to cover all harbors, harbor approach areas, and other critical waterways for which the USCG provides aids to navigation. Each site has a coverage area

between 150 to 300 miles, depending on the transmitter power, terrain, and signal interference. Since the sites utilize an omnidirectional transmitting antenna, some areas have overlapping coverage. Currently the system covers all U.S. coastal harbor areas; the Mississippi, Missouri, and Ohio Rivers; and the Great Lakes Region. Figure 7-1 depicts the system coverage as of 2009.

c. User Requirements and equipment. To receive and apply pseudo-range corrections generated by the USCG reference station, the user needs to have a radiobeacon receiver with antenna, and, at a minimum, a L1 C/A code GPS receiver with antenna. The radiobeacon receiver demodulates the signal from the reference station. Most beacon receivers will automatically select the reference station with the strongest signal strength or allow the user to select a specific reference station. A beacon receiver can be connected to most GPS receivers. The GPS receiver must be capable of accepting RTCM Type 9 messages and applying these corrections to compute a position. Since the reference station generates corrections only for satellites above a 7.5-degree elevation, satellites observed by the user's GPS receiver below a 7.5 deg elevation will not be corrected.

d. EM 1110-1-1003 provides additional information on code phase positioning and recommended receiver specifications.

e. FAA Wide Area Augmentation System (WAAS). The FAA has developed the WAAS to augment GPS, primarily for aviation users. The WAAS provides a signal-in-space to enable WAAS users to navigate the en route through precision approach phases of flight. The signal-in-space provides three services: (1) integrity data on GPS and Geostationary Earth Orbit (GEO) satellites, (2) differential corrections of GPS and GEO satellites broadcast on L1 to improve accuracy, and (3) a ranging capability to improve availability and continuity. Receivers that are capable of processing WAAS corrections may be employed for hydrographic survey purposes where WAAS coverage is available.

7-9. Commercial Differential Navigation and Positioning Systems. Numerous commercial systems provide regional or worldwide coverage. All have USACE application in positioning hydrographic surveys. The following paragraphs describe a few of these systems.

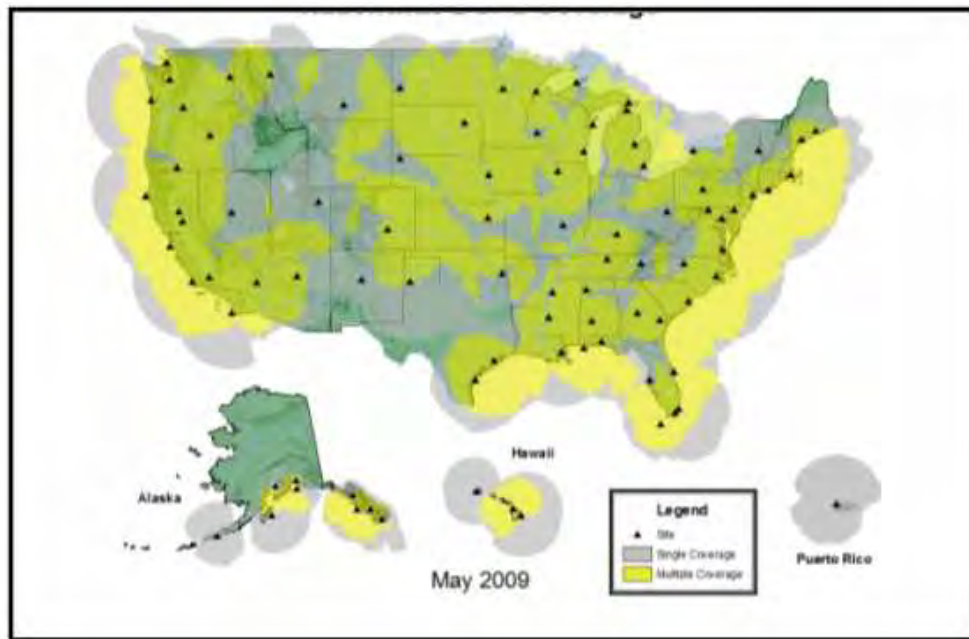

Figure 7-1. USCG Radiobeacon DGPS coverage including USACE coverage in inland navigation system (2009)

a. C-Nav (C&C Technologies). C-Nav is a dynamic differential GPS/GNSS Precise Point Positioning system maintained by C&C Technologies of Lafayette, LA. It provides real-time worldwide coverage (Figure 7-2) with a claimed 1- σ accuracy of <0.1 m horizontally and 0.2 m vertically. C-Nav's solution is based on Real Time GYPSY technology developed by NASA's Jet Propulsion Laboratory to provide centimeter-level accuracy for navigation in space and for a range of complex spacecraft maneuvers. C-Nav does not suffer from the effects of spatial decorrelation found in traditional DGPS systems, nor does it require seeing common GNSS satellites. A C-Nav subscription, combined with C-Nav hardware, which is maintained by C&C Technologies, will provide worldwide positioning capability of 10cm or better. (Excerpt from C&C Technology web site 2011).

b. Fugro satellite positioning. The Fugro DGPS subscription service provides worldwide DGPS coverage in real-time under the brand names Starfix, Seastar and Marinestar. (Figure 7-3.) Within these products there are differing levels of accuracy, ranging from code based sub-meter accuracy to GNSS phase based services with an accuracy of 10 cm (95%) horizontally and 15 cm (95%) vertically.

(1) Within these Fugro services are two, independent, phase-based, Orbit and Clock solutions. The Fugro G2 Orbit and Clock solution uses both GPS and GLONASS satellite observations to produce a decimeter level service, while the second, called XP, produces a GPS Orbit and Clock solution that is generated from a completely separate system of reference sites and software to produce an independent decimeter level service. A third set of reference sites is used to produce another phase-based GPS solution, called HP, that uses local reference site data to generate a

decimeter level service. Another option includes a sub-meter, virtual code solution based on using multiple reference station corrections that are optimized for the user location.

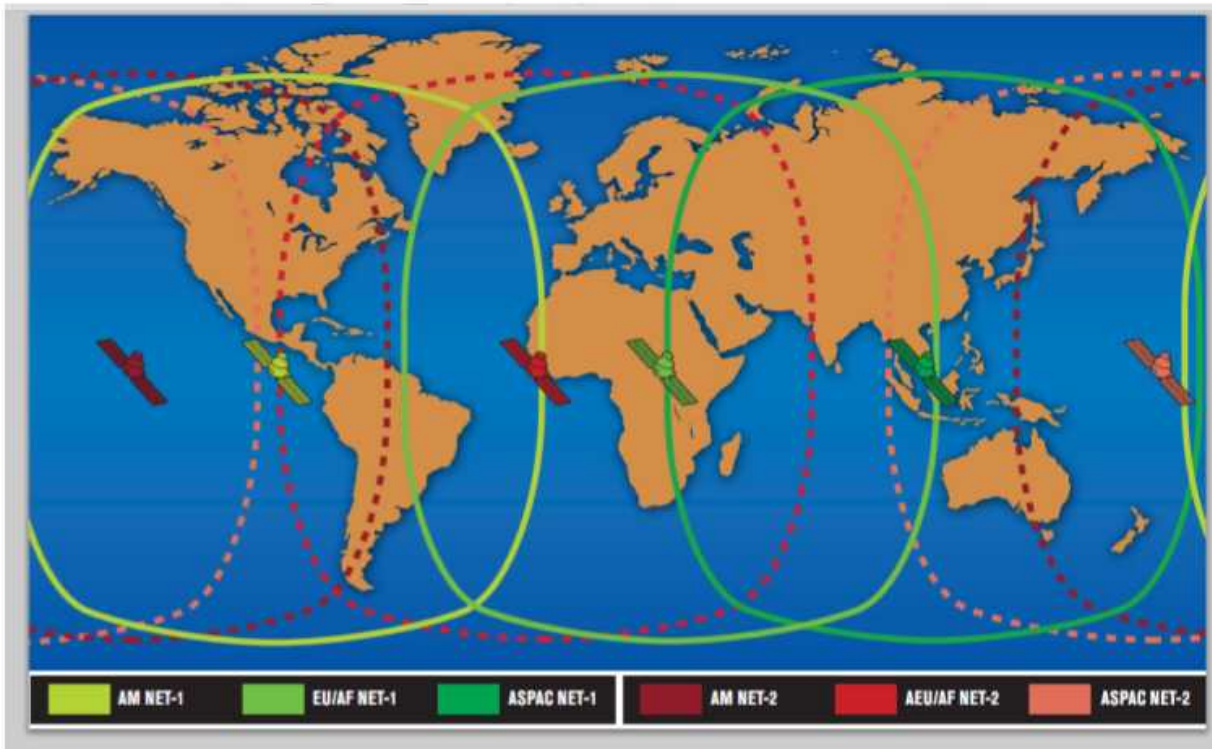

Figure 7-2. C-Nav worldwide coverage map—2011. (C&C Technologies)

(2) Fugro uses a series of eight satellites in order to provide simultaneous coverage from two satellites in all of the marine markets around the world. These satellites are managed from two fully manned Network Control Centers, each of which is capable of up-linking all signals worldwide. Each satellite carries all three of the higher accuracy options. Future capabilities will include higher accuracies and thus higher resolution.

7-10. Position Quality Control Tolerance Checks. Most precise DGPS augmentation systems are capable of providing 1- to 2-meter accuracies at "reasonable" distances from the nearest reference station. However, at increasing distances, spatial decorrelation errors (due to differing ionospheric/tropospheric conditions) can induce systematic positional biases. In general, under nominal atmospheric conditions, a 2-m RMS (95%) positional accuracy may be achieved at distances upwards of 150 miles. During adverse weather fronts, positional errors of 5 meters or more have been observed; thus, positional accuracy checks are important. To confirm a positional accuracy is within a 2-m tolerance, it is recommended that a static check position be obtained at some known survey point near the project. When operating with the USCG maritime

beacon system, static positions should be observed from different radiobeacon reference stations to ascertain if positional systematic biases are present—and select the beacon with minimal biases. In

EM 1110-2-1003

30 Nov 13

practice, this would normally be the closest beacon. If no fixed survey point is available, then a static comparison of different USCG beacon positions should be observed;

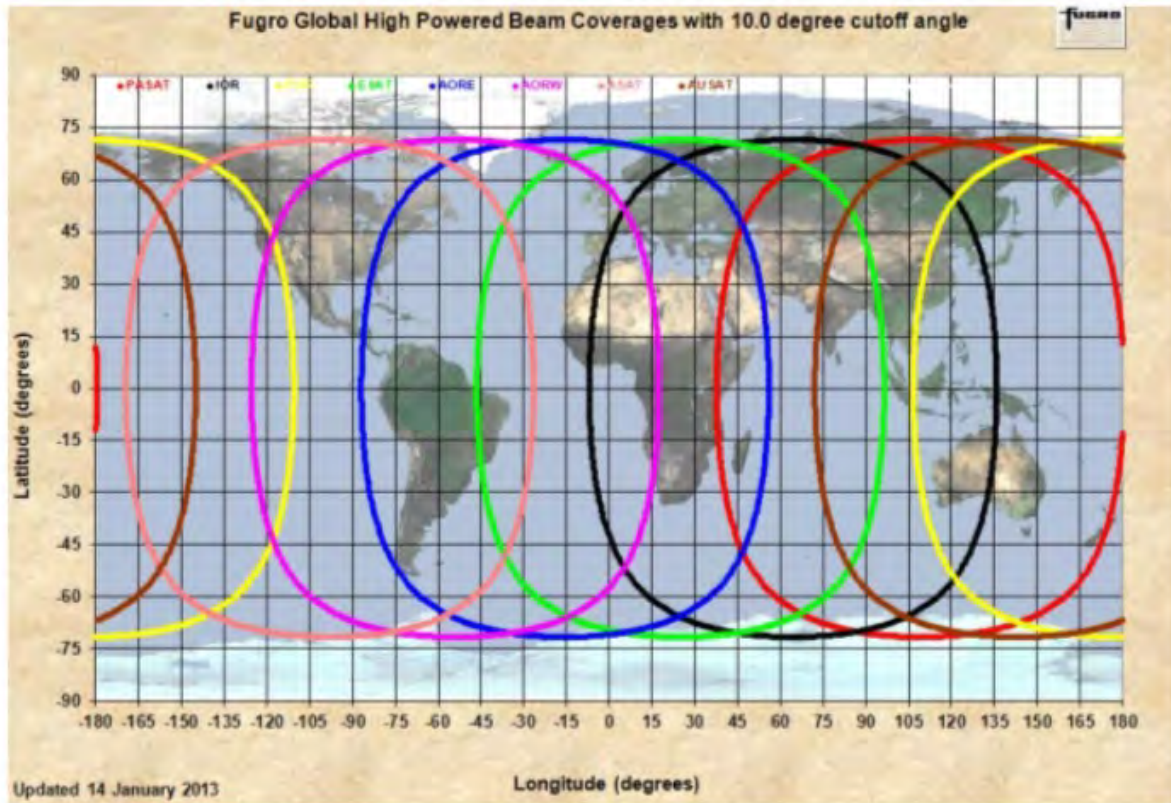

Figure 7-3. Fugro worldwide coverage map—2013. (Fugro)

however, any large biases between beacon positions may be ambiguous. When large or ambiguous positional biases occur in a project area, it may be necessary to establish a local GPS network (code or RTK carrier) if high positional accuracy is critical to the project. Commercial WAAS systems should be checked in a similar manner.

SECTION II

Real-Time Kinematic Carrier Phase GPS Positioning

7-11. Real-Time Kinematic (RTK). RTK carrier phase measurements are increasingly being employed for hydrographic surveys of civil works projects. It is expected that, in the future, RTK positioning will replace code DGPS methods. This is due to the enhanced accuracy and reliability of RTK measurements, and the increased availability of RTN networks. Carrier phase measurements can provide real-time elevations of survey vessels, dredges, and other moving platforms, and indirectly, the elevation of the water surface, from which acoustic depths are calibrated and referenced to. Some districts now mandate that carrier phase RTK positioning be used for water surface elevation measurements on all navigation projects.

a. Carrier phase RTK positioning is performed similarly to code phase DGPS methods in Section I. The main difference is that the short wavelength carrier phase is used to resolve satellite ranges to centimeter level resolutions. This method of carrier phase positioning and elevation measurement is commonly referred to as “real-time kinematic,” “RTK surveying,” and “RTK Tides.” Other organizations call it “Ellipsoid Referenced Surveys,” or ERS. This is because GPS elevations are referenced to the WGS84 ellipsoid and this ellipsoid height must be transformed to the user's reference datum (e.g., LWRP, MLLW).

b. RTK systems are typically capable of 0.1-ft accuracy in static observations, both horizontally and vertically. However, this accuracy is somewhat degraded on moving survey boats due to vessel motion. Various inertial systems and filtering techniques are used to smooth out these motions, and obtain an average water surface elevation. If adequate motion compensation equipment is used, and project tidal datum modeling has been accomplished, water surface elevations can be referenced to the local project datum; allowing observed soundings to be directly corrected to the reference datum.

7-12. RTK System Requirements. Either a local RTK base station is established at the project site or signals from a permanent “Real-Time Network” (RTN) are used. This section outlines the procedures for performing hydrographic surveys using a local RTK base or RTN. (Post-Processed Kinematic-“PPK”-is covered in a later section.)

a. Reference station. A GPS reference receiver must be located over a known survey monument. The reference station receiver must also be capable of collecting both pseudo-range and carrier phase data from the GNSS satellites. The reference station will usually consist of a dual-frequency, geodetic quality GPS receiver with its associated antenna and cables, processor, and communications link. (See EM 1110-1-1003 for recommended GPS receiver specifications.) The receiver should be capable of at least a 1-sec update rate. The processor used in the reference station will measure the pseudo-range and carrier phase data and format the data for the communications link to the survey vessel.

b. Separation distances. The distance between a RTK base station and the project site is usually kept as short as possible, typically less than 10 miles. At greater distances, integer ambiguity and initialization problems may occur; notwithstanding the communication link’s range. Some RTN applications can extend the effective coverage range.

c. Communications link. The communications link for the carrier phase positioning system differs from the code phase DGPS system given the higher amounts of data that have to

be transmitted. VHF and UHF frequency communications systems are used as communication links. Cellular network and satellite communication systems are also viable communication links for carrier phase positioning systems.

d. User equipment. The user equipment on the survey vessel or dredge consists of a carrier

EM 1110-2-1003

30 Nov 13

phase, dual-frequency, geodetic survey quality GPS receiver with a built in processor and associated antenna. The built in processor must be capable of resolving the integer ambiguities while the platform (survey vessel or dredge) is moving. Using a “geodetic quality” GPS antenna will reduce the effects of multipath on the GPS signal. A communications link is needed on the dredge or survey vessel to receive data from the reference station. Frequency approval may be necessary for communication link broadcasts using a power source in excess of prescribed levels. The position output for the helmsman is often code phase DGPS using pseudo-ranges (accurate at the meter level) for vessel navigation in real time. Carrier phase data will be time-tagged to allow for recording the true vessel position needed for survey processing. The minimum update rate from the reference station to the vessel(s) is 1 sec. Higher update rates on some RTK systems will provide enhanced vessel heave correction input.

e. Ambiguity resolution. High-precision kinematic positioning is available from the system once the receiver’s processor resolves integer ambiguities. As long as the system remains in the RTK mode, real-time sub-decimeter positioning in three dimensions is available at the remote station or platform. To remain in this RTK “fixed” mode requires both the reference station and the remote station receivers to maintain lock (continuous GPS data) on at least four (and often five) satellites. If that number drops, the RTK fixed solution goes into "float" mode, and the ambiguities will again be resolved after the system reacquires lock on a sufficient number of satellites and reinitializes. Reinitialization may also be triggered if quality factors based upon residuals failing to meet certain predefined limits.

7-13. Real-Time Networks (RTN). Numerous public and private real-time networks have been established throughout CONUS that provide carrier phase correctors for survey users. These networks blanket a region with multiple base stations, and through various modeling techniques, can extend RTK coverage beyond that from a single reference station. Thus, remote channels in large bays may be covered. Where RTNs exist over Corps projects, districts can utilize these networks; thus, eliminating the need to set up RTK base stations at each project site. Many of these RTNs have been established by state DOTs and commercial providers. During the mid 2000s, Philadelphia District established a RTN to cover inland and offshore reaches in the district—see Figure 7-4.

7-14. Inertial-Aided Post-Processed Kinematic (IAPPK) Position and Elevation Computations.

Post-processed kinematic (PPK) is simply post-processed RTK observations. It may be used when real-time communications between the base and survey vessel are unavailable, often in distances greater than 10 miles. Applanix “POSPac” software provides an option to post-process inertial-aided POS/MV/RTK observables in a CORS adjusted virtual reference network type solution. POSPac post-processes 5 to 10 CORS stations within 200 km of the vessel, and performs a network solution. POSPac has application in areas beyond RTK or RTN coverage, or outside of radio or cell coverage. This would include coastal borrow areas 15 or more miles



Figure 7-4. Philadelphia District RTN coverage of navigation projects in Delaware Bay.

offshore, large water bodies, lakes, or bays, and remote reservoirs. POSPac software allows merging of CORS observables with local RTK base stations. If either local RTK or RTN data is lost, then CORS solutions will maintain the required vertical accuracy needed to determine the water surface elevation at the survey site. Since POSPac is a post-processing method, real-time vessel navigation during CORS-only coverage will revert to DGPS—e.g., USCG Maritime System. In remote offshore areas, predicted geoid models must be used. Likewise, tidal range data must be derived from VDatum estimates or other models—see EM 1110-2-6056. Appendix I describes the process for implementing and operating POSPac software to compute accurate water surface elevations (“RTK Tide Corrections”) in offshore areas beyond local RTK or RTN coverage.

SECTION III

RTK Water Surface Elevation Measurement

This section covers the use of carrier phase RTK measurements to obtain the elevation of the water surface at the project site. These techniques are usually referred to as “RTK Tides,” however, the elevation of any non-tidal river stage, reservoir, or pool may be determined using these “RTK Tide” methods. RTK Tide techniques are especially applicable in coastal areas with significant tide ranges and tidal phase (time) differences between the reference gage and the project site (see example in Chapter 2). Additional information on the use of RTK elevations can be found in EM 1110-2-6056.

7-15. RTK Surface Elevation Requirements in Coastal Navigation Projects. A major correction to depths in navigation project surveys is for tidal phase (latency) variations between the reference tide gage and the location of the dredge or survey vessel at the project site. Local hydrodynamic and meteorological effects (e.g., wind set up) changes the water surface elevation profile in the project. These variations due to tidal phase, along with other hydrodynamic or meteorological effects, increase with the distance from the tide gage. These systematic differences can exceed 1 to 2 ft in moderate range projects, and higher on projects with large tide ranges (over 10 ft); especially during adverse weather conditions. They are most pronounced during periods of full ebb and flood tide. Many dredging measurement and payment survey disputes and claims arise over lack of adequate compensation/correction for tidal phase and meteorological surface set up throughout a project site.

a. Tidal phase latency variations. EM 1110-2-1100, Coastal Engineering Manual, Part II-6, “Hydrodynamics of Tidal Inlets” has numerous examples of the tidal phase and MLLW range variations that typically occur between the ocean and bay at a typical coastal inlet. These tide curves do not include any hydrodynamic or meteorological effects, which could, at times, exceed the basic tidal phase variations. Modeling and correcting these tidal phase variations throughout the project is critical.

b. Water surface elevation measurements using RTK techniques. Tidal phase errors and weather/sea surface set up can be measured using RTK surface elevation measurement techniques, often coupled with inertial measurement and orientation systems. Local water level variations can be measured in real-time using these RTK techniques, either from a local RTK base station set at a project control benchmark or from a regional RTN system. RTK methods effectively measure the local water surface elevation relative to the ellipsoid; thus, providing direct corrections relative to a MLLW datum at a modeled offshore construction or large project site.

(1) RTK methods apply a geoid model to correct observed ellipsoid heights measured relative to the vessel GPS antenna; thus, the orthometric elevation of the antenna is computed. Knowing the distance from the antenna down to the vessel's water surface draft, the corrected orthometric elevation of the water surface is obtained. Since acoustic depths are calibrated relative to this nominal water surface (e.g., bar checks), they can be directly related to an orthometric datum at each point. If the MLLW datum is modeled relative to the reference gage, then the observed depths can also be corrected for any MLLW variations.

(2) Thus, observed depths have been corrected for (1) geoid model undulations, and (2) tidal range variations based on hydrodynamic models of the tide in the region. The actual offshore water

surface level above local MLLW is thereby measured at every observation (typically 1 to 10 Hz) made by a survey vessel, dredge, or commercial vessel employing RTK methods. As long as every user (vessel) employs the same geoid and tidal models for the region, then full repeatability of surface elevation measurements will be achieved. The relative accuracy of the RTK measured surface elevation and tide level will fall around ± 0.05 - to 0.1-ft level with appropriate motion sensing and filtering.

(3) Geoid model accuracy is a function of the location and density of NSRS vertical control and gravity data in the area. The predicted geoid undulation from the latest geoid model will be used for offshore entrance channels—areas that obviously have no vertical control but have geoid height estimates using other techniques (airborne gravity). NGS should be contacted to confirm the accuracy of the predicted geoid model does not exceed reasonable tolerances. Likewise, the predicted tidal range in offshore entrance channels 3 to 10 miles seaward may have to be based on established regional models of the ocean tides. In such cases, the estimated accuracy of these regional models may be verified by contacting Engineer Research and Development Center/Coastal Hydraulics Lab or NOAA. Alternatively, these offshore tidal ranges, and indirectly the geoid model, can be confirmed by observing long-term RTK data recorded during the course of a survey in the area.

(4) Geoid and tidal models developed for each project must be published and disseminated to all users. This may be a simple ASCII file in the form of a gridded difference between NAVD88 and MLLW (NAVD88-MLLW), such as a “KTD” file used by commercial navigation dredging software (HYPACK). Since most USACE navigation projects are linear, only a 1D model may be required—e.g., a tidal-geoid correction every 100-ft station down the channel centerline. This is adequate to cover the areal extent of a 100-ft- to 1,000-ft wide-channel. This file may be periodically updated if the MLLW tidal model for the region is significantly modified by NOAA. Thus, the file must clearly identify (metadata) the source of the data. In some navigation/dredging processors, the geoid correction may be performed separately by the GPS receiver from the MLLW tidal model correction. Thus, the KTD file will usually contain only the tidal datum correction (NAVD88-MLLW or "K") or may combine both the tidal datum correction "K" and the geoid correction "N"—i.e., “(N – K).” Users must also be advised that RTK, like any measurement system, must be periodically checked (and site calibrated/localized if necessary) against a physical recording tide gage or staff gage.

7-16. RTK Tide Corrections. The following paragraphs illustrate some of the basic concepts behind the determination of a water surface elevation using RTK technology.

a. Definitions.

(1) “RTK Tide.” RTK Tide is the computed measurement between the reference datum (e.g., MLLW, LWRP, IGLD, etc) and the local water surface elevation. RTK Tide could thus be “RTK Stage” or “RTK LWRP.” RTK Tide is not the “True Tide” but is really a “RTK Corrector” that is applied to the observed depth. This is because “RTK Tide” only is the same as a “True Tide” reading when a vessel is stationary. When the boat is in motion, the dynamic draft (D) enters into the “RTK Tide” solution rendering a “RTK Corrector” to an observed depth.

(2) “KTD File.” The KTD file is used in HYPACK software to correct observed RTK ellipsoid heights to the local datum. Usually this entails determining local geoid height “N” and the modeled difference between the geoid and water level reference datum, or “K” (e.g., MLLW, LWRP, IGLD, MSL). Typically, the geoid height is automatically obtained from the current geoid model and only the “K” relationship is required in the KTD file. In small survey areas where changes in “N” or “K” are minimal, a KTD file is not required in HYPACK and these parameters can be entered as “ortho height corrections.”

b. RTK Tide correction schematic. Figure 7-5 depicts the computational process for determining the elevation of the water surface based on RTK ellipsoid observations. Refer also to the HYPACK Software Users Manual (HYPACK 2011). Note that in Figure 7-5, the z-axis is shown as positive upward. This is valid in any topographic survey, where downward slopes would be shown from a higher elevation to a lower elevation. Many engineering projects, i.e., beachfills or revetments, maintain this convention and show elevations underwater as negative numbers. Hydrographic surveying for navigation, however, reverses the direction of this sign to avoid repetitive negative signs on nautical charts and sounding plots. For example, a depth of 40 ft below the chart datum is shown as “40” not “-40”. HYPACK software reverses this sign in the software. This can also be illustrated by comparing the tide value in the software in real time to a conventional tide staff. For example, a reading of 3.0 above “0” on the staff will be displayed as -3.0 in the software.

(1) “H (ortho elev)” is the orthometric elevation of the base RTK station. The orthometric elevation is the height above the geoid, which is approximated in CONUS by NAVD88 using the standard relationship “ $H = h - N$,” where “H” is the orthometric height (e.g., NAVD88), “h” is the GRS80 ellipsoid height, and “N” is the geoid height (e.g., GEOID09). (The “HI” represents the height of the antenna phase center above the benchmark. The antenna height measurement must be confirmed in the field.)

(2) “N” is the height of the ellipsoid above the geoid (as read from the current geoid model in real time). “N” will vary (geoid undulation - ΔN) with location as illustrated in Figure 7-5. This variance is obtained from the latest geoid model. By incorporating the geoid model into the real-time solution, the observed ellipsoid height measured at the vessel is continuously corrected for geoid undulation at each position update. Over small survey areas near the base station, this geoid undulation may not be significant and may be assumed constant.

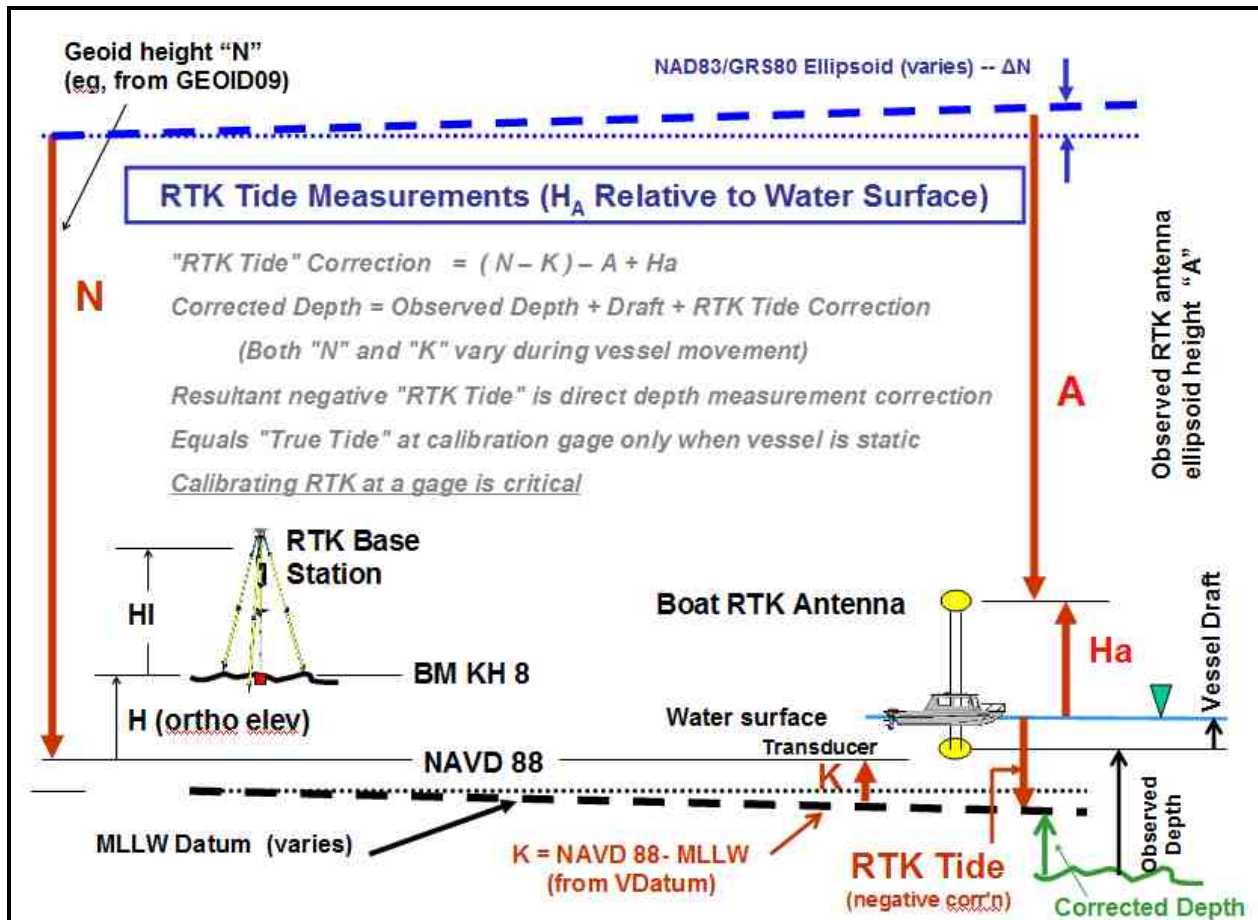

Figure 7-5. RTK Tide Correction Measurements. The RTK Tide Correction is measured relative to the nominal water surface (vessel vertical reference point = 0), not the transducer. Note that the z-axis is shown positive whereas in HYPACK z measurements are positive downward.

(3) "K" is the orthometric height above the chart datum, e.g., NAVD88 – MLLW. "K" will vary in tidal areas with changes in the tidal range. "K" has been modeled by NOAA in most CONUS regions—"VDatum." Over small areas a constant "K" may be assumed. In the Great Lakes, "K" would represent the difference between IGLD and the low water datum. Likewise, on USACE reservoirs and navigable rivers "K" will vary with the pool or low water reference plane.

(4) "A" is the observed ellipsoid height of the vessel's antenna above or below the reference ellipsoid—in this example the antenna is below the ellipsoid. This is broadcast as a part of a GGA, GPK, or other message from the RTK system. It is corrected for geoid undulation (ΔN) at the survey location.

(5) "H" is the static height of the RTK antenna above the water line. In order to maximize accuracy, this measurement should be taken at the same time the echo sounder is calibrated (bar checked) relative to the water surface.

(6) “D” (Dynamic Draft) represents the vertical movement of the transducer in the water column. When using RTK, there are no dynamic draft corrections. (The “Static Draft” is determined from periodic bar checks and remains in the depth solution equation).

(7) Not shown in Figure 7-5 would be a calibration correction if needed to ensure the static RTK Tide equals the actual tide at the reference gage. The HYPACK “orthometric correction” may be used for this calibration correction.

7-17. Heave Correction Options from RTK Measurements. RTK observations may be used to measure vessel heave motion. They may be used in conjunction with, or a supplement to, heave from inertial motion sensors. In HYPACK, two options are available on how the software combines RTK water level elevations with heave corrections. (1) Option 1: “Merge Tide Data with Heave” uses the RTK elevations as vertical “anchors.” Between the GPS elevation updates, the program “fits” the heave data to predict the change in vessel movement. (2) Option 2: “Average Tide Data to Remove Heave” averages the RTK elevations over a user-defined time period to obtain a “normalized heave plane.” In theory, this average vertical level should be the zero plane as defined by the heave-pitch-roll sensor. The program then applies the exact heave corrections to the data to obtain the exact vessel position at the time of the depth measurement. A time period of 30 seconds is typically used. (Option 2 is the recommended method.) If high update RTK rates are available (e.g., > 10 Hz) then direct heave measurements may be computed independent of any MRU input.

7-18. KTD File Generation from VDatum. NOAA's "VDatum" provides a modeled relationship between orthometric datums and tidal datums in coastal waters. Usually the NAVD88-MLLW model is used on Corps navigation projects. (A detailed description of VDatum is covered in EM 1110-2-6056). Although HYPACK contains a built in VDatum database, generating a "KTD" file allows edits to be made to the raw VDatum data. These edits are often necessary since anomalies may (do) exist in some VDatum models. These anomalies may include insufficient coverage or errors in the model itself. The KTD file can be edited (by interpolation or extrapolation) to correct any deficiencies in VDatum. In coastal areas, KTD files are typically only the “K” values—“NAVD88 – MLLW.” Various techniques have been developed in districts to create a KTD file from the NOAA VDatum database. An example of a KTD file near a coastal entrance project is shown at Figure 7-6.

SECTION IV

Vessel Motion and Orientation Measurement

This section describes some of the systems used to measure vessel motion, orientation, and alignment; namely, roll, pitch, yaw, and heave.

7-19. Motion Reference Units (MRUs). (Figure 7-7) MRUs are generally designed to provide real-time vessel orientation alignments, typically outputting vessel heave, roll, yaw, and/or pitch. MRUs are variously referred to as “Motion Sensors,” “Heave-Roll-Pitch Sensors,” “Inertial Measurement Units”—IMU,” and “Inertial Navigation Systems”—INS. Inertial systems usually consist of three gyros and three accelerometers, providing dynamic rotational data (yaw, pitch, and roll) and acceleration data (heave, surge, and sway). MRU rotational data is critical in



Figure 7-6. Example of a KTD file generated from VDatum. (Ocean entrance to Mayport Naval Base, St. Johns River, FL). “K” values are “NAVD88 – MLLW.” Note incorrect VDatum and KTD interpolation on north side of entrance, between the river and tidal pool. This region required manual edits to the KTD file to correct. Published NOAA gage 8720214 “K” at South Jetty agrees closely with VDatum “K.”

correcting observed multibeam array data. Heave data is essential in filtering out short-term and long-term sea swell biases; for both single-beam and multibeam sonar systems. Vessel heading calibration is typically provided to the MRU from a separate sensor (e.g., GPS, gyro, compass, etc.). A variety of MRUs are available, such a ring laser and fiber optic designs. These are essential in providing accurate corrections to vessel motion. a. HYPACK MRU data input. The MRU heave-pitch-roll data is saved in the HYPACK Raw data files as “HCP Records.” These records contain the Device Number, Time Tag, Heave, Pitch, Roll, and Status Flag. The HCP records are used when processing data in the SINGLE BEAM EDITOR for single and dual frequency data, or the HYSWEEP EDITOR program for multiple transducer and multibeam data. Each program takes the exact time of the depth measurement and then interpolates heave-pitch-roll information for the exact time that the depth was measured (HYPACK 2011).



Figure 7-7. Motion Reference Units (MRU).

b. HYPACK Single Beam Editor. In the Single beam Editor, selected options specify how the heave-pitch-roll information from a motion reference unit (MRU) will be applied. These options include: (1) “Apply Heave Correction” - determines a heave correction for every sounding, (2) “Apply Pitch and Roll Corrections” - used to offset the position of the transducer from the navigation antenna, (3) “Remove Heave Drift” - corrects heave values that have drifted off center due to rapid accelerations or changes of direction, or (4) “Steer Sounding Beam” - computes the X-Y coordinate for the point where the center of the transducer cone hits the bottom, based on the pitch and roll data (rather than directly below the transducer) then calculates the corresponding depth.

c. HYPACK HySweep Editor options. If POS/MV Group 111 data have been logged during the survey, the editor programs include a specialized routine that applies that "true heave" data to the multibeam sounding data. The editor recomputes the heave over the specified survey time period, updating the real-time heave with a delay to obtain the “true heave” based on the delay.

7-20. Inertial Aided GPS Motion Measurement. Many districts are now using inertial aided GPS to correct vessel motion in multibeam systems. These systems include the Applanix "Position and Orientation System for Marine Vessels" (POS/MV) and the Coda Octopus "F180 series." (Figure 7-8). These systems determine vessel position, elevation, and orientation, including heading. They combine IMU data with carrier phase GPS observations from two receivers. The two receivers establish a baseline relative to the vessel, thus producing the heading (yaw) value. These systems are recommended for critical dredge measurement and payment surveys. The following are descriptions of these systems taken from manufacturers specifications. These are current at the time of publication.

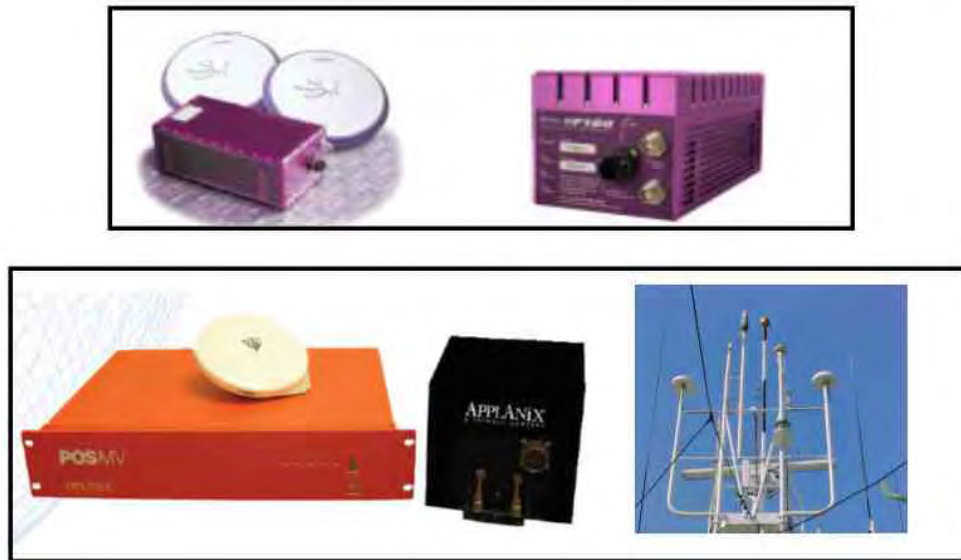

Figure 7-8. Inertial-aided GPS systems. Coda Octopus F180series (top) and Applanix POS/MV (bottom). Typical positioning and orientation accuracies are better than 2 to 5 cm (position), 0.025 deg (roll & pitch), heading (0.05°), and heave (greater of 5 cm or 5%).

a. Applanix POS/MV. The Applanix POS/MV provides a six degree-of-freedom position and orientation solution measuring location, velocity, attitude, and heave, plus acceleration and angular rate vectors. The system provides orientation updates at 200HZ, allowing motion corrections and georeferencing of multibeam array depth observations. With inertially-aided RTK, the POS system's Kalman filter also estimates the floated phase ambiguities. Integer ambiguities are fixed using an on-the-fly (OTF) ambiguity resolution algorithm. After a full outage, RTK is typically recovered in 5 to 10 seconds; and after a partial outage, RTK may be recovered in as quickly as 1 second. Refer to POS/MV 2011 in Appendix A for additional information.

b. Coda Octopus F180. The primary function of the F180 is to determine the motion of the vessel it's fitted to – specifically heave, pitch, roll and heading. Motion measurements are derived from a dual antenna GPS system; the GPS receiver inside the attitude sensor derives the heading from a local integer RTK solution between the two antennae. The gyros and accelerometers within the unit allow high accuracy measurements of the changes in these values between GPS updates. These changes are fed into the INS to calculate a position estimate.

c. Figure 7-9 illustrates the flow process between the IMU and the GPS systems in the Applanix POS/MV. Vessel orientation (heading) is obtained from the dual antennas (primary and secondary) rigidly mounted atop the survey vessel. GPS data are input to the processor where ambiguities are resolved (“On-the-Fly”) and data are filtered. The “Inertial Navigator” merges the filtered GPS data with the orientation data from the IMU to arrive at a “blended navigation

EM 1110-2-1003

30 Nov 13

solution” as shown in the figure. Heave data are pulled from the IMU for separate analysis to obtain “true heave” from the instantaneous real-time heave observations—see following section.

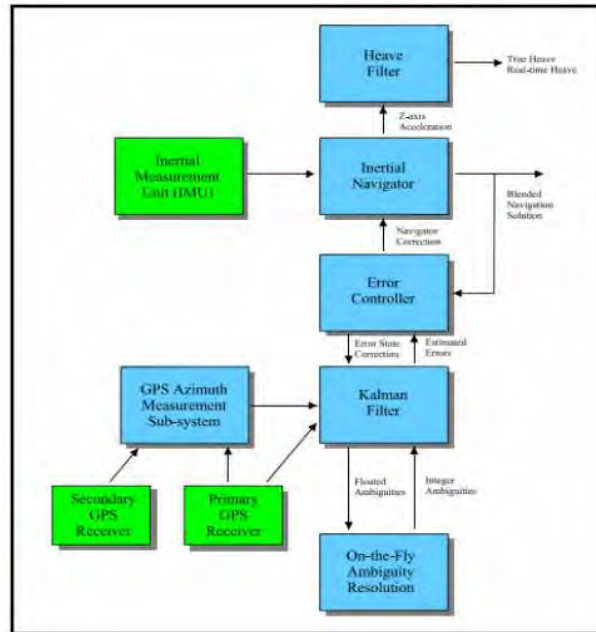

Figure 7-9. Flow diagram of an inertially-aided RTK system. (Applanix)

7-21. Vessel Heave Corrections and Considerations.

a. Heave is the effect caused by the action of sea and swell on the survey vessel, and is measured with inertial sensors or heave compensators. When using inertial sensors, installation should be close to the centre of gravity of the survey vessel with the known lever arms from the centre of gravity to the transducer; with the roll and pitch instantaneous angles, the measured heave can be transferred to the transducer position, through the application of the induced heave—see Figure 7-10. To calculate the induced heave, consider the vessel to be a rigid body that is free to rotate around the three axes (x , y , and z). The rotation about the centre of gravity (roll and pitch), near which heave is usually measured, corresponds to a transducer depth variation, from the vessel reference frame to a local co-ordinate system. This difference is called induced heave. (IHO 2005).

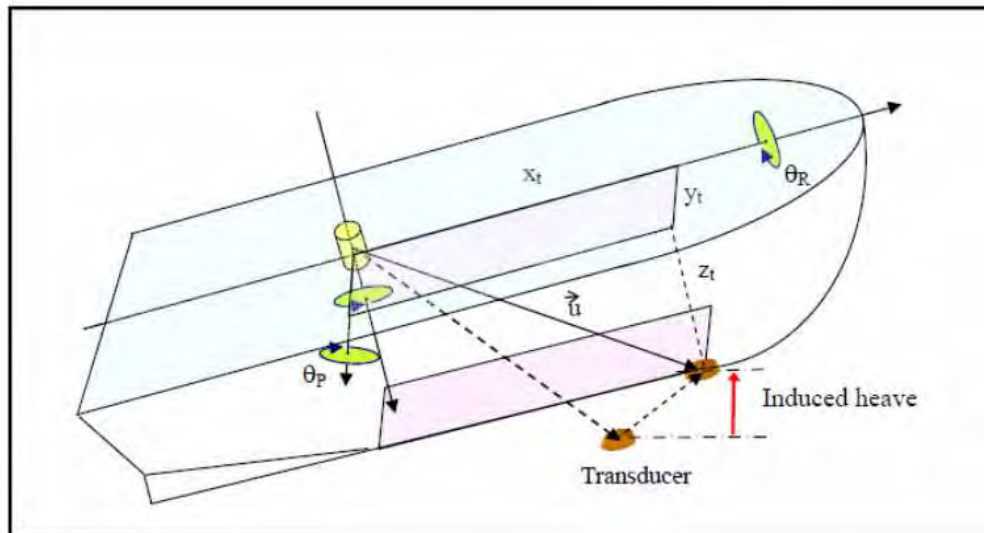

Figure 7-10. Measured heave at the IMU and induced heave at the transducer.

b. True Heave. (Portions of the following are excerpted from OCS 2011.) Heave data are calculated using a double integration of acceleration over a period of time. When recording heave in real-time, the calculation is performed using only past measurements of acceleration. An improved estimate of vessel low-frequency heave can be calculated by performing the integration over a time period centered on the time of interest, resulting in a “True Heave” value (also referred to as “delayed heave”). The difference between observed real-time heave and True Heave is illustrated in Figure 7-11. “True Heave” is an option available with POS/MV. True heave is effective across long-period wave conditions (16- to 30-second period swell), whereas a real-time heave filter tends to exhibit its most notable artifacts in such conditions (>16 seconds). True heave is also effective when performing surveys within areas where the observed swell period is dynamic (i.e., when surveying into the oncoming swell vs. in the same direction as the swell). This is affected (up to 30% of observed swell height) by the settling rate and cannot be fine-tuned in both directions. For this reason, we cannot observe true heave until after the real-time heave has been observed. (Note: True Heave does not replace the need for dynamic draft corrections or water level corrections.) True Heave is logged using the POS/MV Controller software, via the Ethernet connection to the POS/MV PCS. True Heave data logging must be controlled separately from the primary data acquisition software, but it can be continuously recorded throughout the day. The True Heave filter requires a period of up to five (5) minutes after it has been enabled to initialize. The filter uses vertical acceleration data three (3) minutes past real time; hence, logging must continue for at least three (3) minutes past the ending time of survey line data acquisition. The time base used for True Heave data, "Heave Time 1", is user selectable in the POS/MV Controller software. The UTC (default) should be selected, not GPS time. Refer to the POS/MV User manual for more information regarding the theory, operation, and setup of "True Heave."

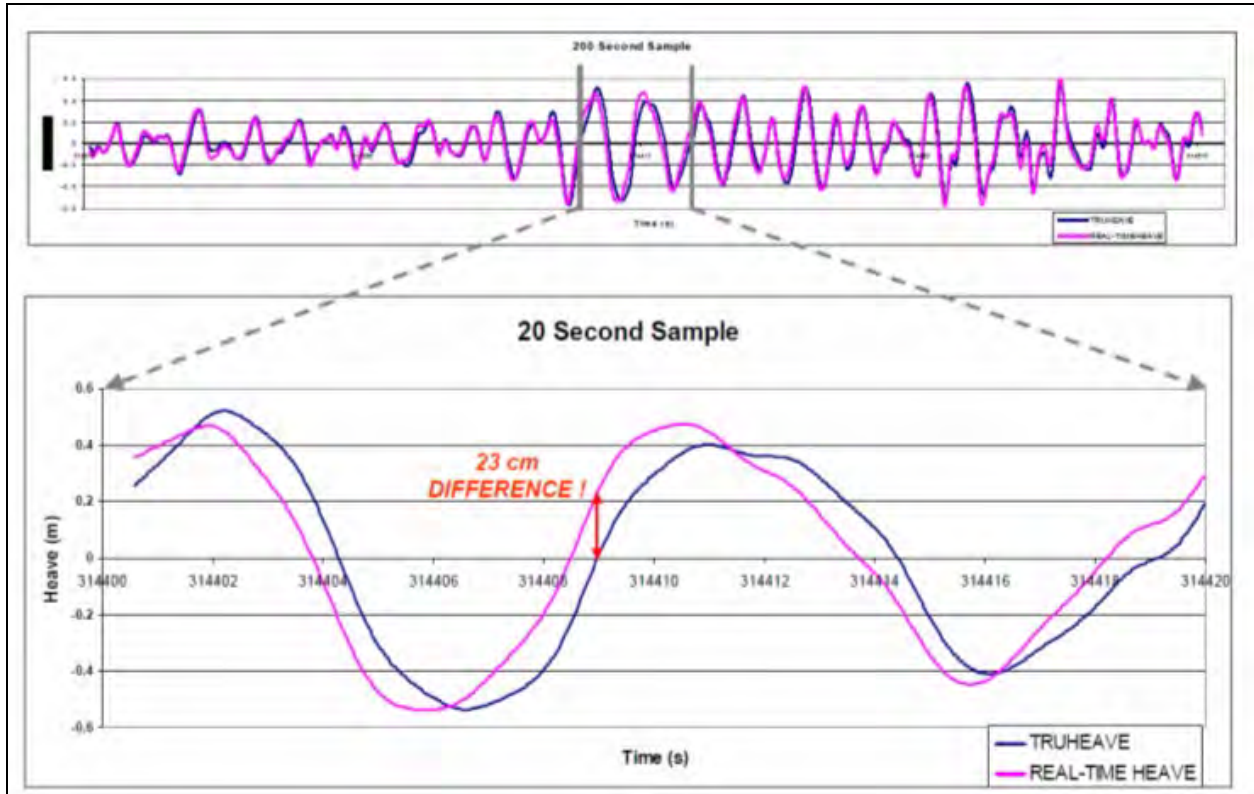

Figure 7-11. Differences between real-time heave and post-processed "True Heave." (Jacksonville District)

c. Quality assurance. Vessel heave corrections must be continuously monitored during survey operations. This is performed by monitoring real-time heave corrections on a screen display, noting any anomalies as the survey line progresses. This is particularly important during and after vessel turns to ensure induced heave on the turn has settled out before the next survey line begins. Office processing should also review heave corrections applied to the data. In cases where heave data has been incorrectly applied the correction will need to be removed.

7-22. Recommended Quality Control Criteria for GPS Positioning Methods. Table 7-1 presents a summary of recommended QC procedures to be followed when using the various positioning and orientation systems described in this chapter. These criteria apply only to dynamic hydrographic survey applications, not to observations made to locate or calibrate a stationary platform or structure.

Table 7-1. Recommended QC Criteria for USACE Hydrographic Survey GPS Positioning

POSITION CHECK RECOMMENDED		1/day at known NSRS or project PPCP or check with alternate positioning system
Acceptable horizontal tolerance	2 m	(code DGPS) 0.1 m (carrier RTK)
RTK TIDE VERTICAL CHECK WITH GAGE		2/day (minimum)
Acceptable tolerance		0.1 ft
LEVER ARM MEASUREMENTS transducer, IMU, GPS antenna, gyro		Determine at initial installation or if sensors are relocated (to 0.1 ft or better). Verify correct settings in software (daily).
HEAVE		Monitor continuously in real-time. (post-process for True Heave)

EM 1110-2-1003
30 Nov 13

THIS PAGE INTENTIONALLY LEFT BLANK

CHAPTER 8

Coastal Navigation Project Channel Condition Surveys

8-1. Purpose. This chapter covers channel condition surveys that are periodically performed on USACE coastal navigation projects to assess channel clearance conditions and evaluate needs for maintenance dredging. These condition surveys are normally performed annually; however, on high shoaling projects, quarterly, monthly, or even daily condition surveys may be required. Survey data is furnished to the public in various formats: digitally, channel condition reports, and hard-copy drawings or maps. The guidance in this chapter outlines procedures for distributing electronic and hard copy map/chart products to local project sponsors, pilots, NOAA, USCG, commercial and recreational waterway users, and the general public. This guidance supplements applicable portions of ER 1130-2-520, Navigation and Dredging Operations and Maintenance Policies, and EP 1130-2-520.

8-2. Scope. This chapter includes technical guidance on condition survey procedures, accuracy requirements, data content standards, technical compilation criteria, and data distribution procedures. It covers periodic project condition surveys of coastal deep-draft and shallow-draft projects, including the Great Lakes and the Atlantic and Gulf Intracoastal Waterway systems. These projects are typically charted by NOAA using Corps-furnished condition survey data. This chapter does not cover the inland navigation system that is mapped or charted by USACE districts—i.e., the Mississippi, Missouri, and Ohio River systems, including tributaries. These inland surveys are covered in Chapter 9. Channel condition survey data includes, but is not limited to, planimetric, topographic, hydrographic, tabular, and related geospatial data contained in CADD, GIS, or other computer-based systems that are used to collect, process, or store data.

8-3. References. Executive Order (EO) 12906, Coordinating Geographic Data Acquisition and Access: The National Spatial Data Infrastructure (NSDI), and Office of Management and Budget (OMB) Circular A-16, Coordination of Geographic Information and Related Spatial Data Activities, prescribe Federal policy and establishes mechanisms for acquiring, processing, storing, distributing, and improving utilization of geospatial data, including making this data readily and freely available to the public via Internet and other media resources.

a. ER 1110-1-8156, Policies, Guidance, and Requirements for Geospatial Data and Systems, provides implementing guidance for the above references. This implementing guidance is applicable to USACE condition surveys of federal navigation projects.

b. Chapter 2 of both ER 1130-2-520 and EP 1130-2-520 provides current policy and technical guidance on the publication of hard-copy charts and project condition reports on USACE navigation projects.

c. Section 554 of the Water Resources Development Act of 2000 (WRDA 2000) states that not later than 60 days after the Corps completes a channel dredging project, NOAA shall be

provided a digital data format of the results of the survey. The only exception is for pre-dredging or pre-construction surveys.

8-4. Overview. Coastal and Great Lakes navigation projects are surveyed at varying intervals, ranging from daily to annually. Each USACE command prepares and distributes these coastal project/channel condition surveys in hard- and soft-copy formats. Hard copy drawings of project condition surveys are typically furnished in a large-scale engineering drawing format (e.g., 1 in. = 100 ft to 1 in. = 400 ft). These data are provided to local sponsors, pilots, and federal agencies. NOAA is a primary user of this survey data—incorporating it onto NOAA charts that cover the project area. NOAA charts are usually at much smaller scales than the large-scale USACE surveys—typically in the 1 in. = 500 ft to 1 in. = 3,000 ft range. As a result of these scale disparities, detailed USACE project condition survey data is not always directly included on NOAA charts, but is summarized on the charts in tables of channel clearances.

8-5. Condition Survey Standards and Specifications. The following guidance is intended to cover periodic condition surveys of coastal navigation projects. Guidance on survey density and coverage options are provided. Survey methods may include either single beam or multibeam techniques, as covered in Chapter 4 and Chapter 6 respectively.

a. Survey frequency. The required frequency of condition surveys is largely dependent on projected shoaling rates, project use, along with maintenance dredging activity and related funding. Shipper's reports and USCG Notice to Mariners are other indicators of possible shoaling in waterways. Most active authorized federal navigation projects are surveyed annually to assess their condition. Inactive projects may be surveyed once every 5 to 10 years, depending on funding. Critical, high volume projects may get quarterly or monthly condition surveys. For example, New Orleans District surveys Southwest Pass continuously (daily). Reservoir sedimentation surveys may have 5- to 10-year condition survey periods. Every project contains unique parameters that require engineering judgment to predict the correct elapsed time between condition surveys. Unless unique circumstances are present (e.g., hurricanes), condition survey schedules should parallel the recurring maintenance dredging work on a given project.

b. Determining density of survey coverage. Coverage density in this section primarily applies to selecting line spacing on single beam surveys. (Multibeam survey techniques effectively provide 100% coverage density.) The line spacing density required for a condition survey is highly dependent on the type of navigation project. Considerations in selecting line spacing include shoaling rates, potential bottom hazards, survey funding availability, and maintenance dredging frequency. Often, condition survey coverage line spacing is larger than that of dredging measurement and payment surveys. However, if the condition survey is intended to be used for construction plans and specifications, then a maximum density of coverage should be obtained. Surveys can be designed to maximize coverage along critical channel navigation points, such as high shoaling areas, and widen line spacing in non-shoaling or natural grade areas. Navigation projects without defined channel limits, e.g., some Intracoastal Waterway projects, may require broader coverage to define the deepest channel alignment. In some instances, shoal areas encountered during a condition survey should be immediately

resurveyed to a higher density suitable for a plans and specifications. On large deep-draft projects, single beam (and multibeam) lines are often run parallel to the channel alignment, near the toes, quarter points, and centerline. On narrow shallow-draft project with minimal maintenance activity, one single beam or wide-angle multibeam line may be run down the centerline to assess the condition.

c. Survey quality control and quality assurance requirements. Condition survey QC and QA should follow the recommended procedures in the respective chapters in this manual for single beam and multibeam systems. This includes ensuring the condition survey is firmly referenced to NSRS control, in accordance with the policy in ER 1110-2-8160, Policies for Referencing Project Elevation Grades to Nationwide Vertical Datums. Requirements for QA Performance Tests may be relaxed if prior (historical) test results were positive and indicate solid repeatability.

d. Depth accuracy standards. Depth accuracy specifications for project condition surveys should follow the recommended guidance in Chapter 3. If Performance Tests were performed, the results from those tests should be indicated on the drawings. Alternatively, if the data will be furnished to NOAA for inclusion on nautical charts, it may be beneficial to indicate if the estimated accuracy (e.g., TPU) meets one of the IHO standards, e.g., “Special Order” or “Order 1a” (IHO 2008). The estimated TPU (TVU and THU) for the condition survey dataset should also be indicated on the drawing note block/level. TPUs in many shallow draft projects will normally meet IHO “Special Order” standards. These IHO “Special Order” tolerances may be difficult to meet on some coastal deep draft projects where tidal models are uncertain and vessel motion is uncompensated. In this case, the IHO “Special Order” standard would not be met and the IHO “1a Order” standard may be applicable, as reflected by the estimated TPU for the dataset. Refer to Appendix E for details on IHO standards.

e. Field Survey Report. It is recommended that the field survey team prepare a "Field Survey Report" for every condition survey. The report should be brief—one to a few pages. It should cover the general highlights of the survey, e.g., datums, control, positioning, equipment, software, QC, QA, raw/edited file archives, issues or problems, etc. The metadata file for the survey may be attached to this report. An example of a Field Survey Report is in Appendix J.

8-6. Topographic Feature Standards for Condition Surveys. The following paragraphs provide general guidance on topographic features shown on condition survey drawings or maps. Features include shorelines, bulkheads, berthing limits, rights-of-way, fixed NAVAIDS, and other various structures. Aerial imagery or terrestrial laser scans may be substituted if adequate to provide feature detail. (See examples in Appendix N.)

a. General mapping feature requirements. Base channel condition drawings/maps should consist of planimetric line drawings depicting critical navigation features within and adjacent to the navigation channel. Features in CADD/GIS formats should be separated by attribute/layer/level assignments. Care should be taken to ensure a linestring depicting a feature is continuous or linked, rather than a series of disconnected graphic elements. Area features

should also be depicted with closed polygons or shapes. Superimposed digital imagery (e.g., orthophotos) is optional. Except for significant landmark items, features should generally be confined to the waterway. Overbank topography needed to define bankline limits on rivers with significant stage variations should also be included. If these base map products will be used for other planning, engineering or construction purposes, then topographic, DEM/DTM, and/or digital orthophoto images may be included as separate layers/levels with the base planimetry.

b. Base mapping feature accuracy standards for navigation projects. Features shown on channel condition survey products should have an accuracy consistent with maritime charting accuracy in order to ensure mutual consistency with positioned features on NOAA charts. IHO 2008 indicates a 6-ft (2 m) tolerance is adequate to depict features that are “significant to navigation.” This feature accuracy tolerance falls within the average accuracy obtainable from GPS receivers using the USCG maritime DGPS radio beacon network along coastal and inland waterways. (Local RTK/RTN networks easily meet this standard.) In some instances, critical navigation features may need to be located to a higher accuracy using conventional survey methods. These features might include fixed navigation aids, lock chambers, lock approach walls, bridge piers/fenders, etc. Short-term (few seconds) static positions with maritime DGPS may provide a sufficient accuracy for these features. Existing as-built drawings may also be used if geographically referenced.

c. Reference datums. All engineering drawings of USACE coastal navigation projects should be horizontally referenced to the current NSRS (National Spatial Reference System). Vertical datums in tidal areas and the Great Lakes should be consistent with NOAA NWLON gage networks. Refer to EM 1110-2-6056 for guidance on NSRS and NWLON datums.

d. Local reference systems. Chainage-Offset coordinates and River Mile systems should be included on all products where applicable.

8-7. Hard Copy Map Scales and Formats. Condition surveys of coastal inlets are typically published at map scales ranging from 1 in. = 100 ft to 1 in = 400 ft. A 1 in = 200 ft scale is most commonly used. Larger scales (e.g., 1 in = 50 ft to 100 ft) may be used in/around critical navigation features--e.g., locks, dams, bridges; however, basic project condition survey map scales should generally not be less (smaller) than 1 in = 400 ft. For Intracoastal Waterway systems, a minimum base map compilation scale of 1 in = 400 ft (1: 4,800) is recommended. A variety of methods may be used to depict the controlling depths and shoals on condition surveys. These include (1) numerical soundings, (2) contours, (3) color coded soundings, or (4) color coded dense pixels. The depth presentation used is also dependent on the preferred requirements of primary users, such as river and harbor pilots. Therefore, varying project-specific formats will be used throughout the Corps. Figures 8-1 to 8-4 are examples of different condition survey plan formats from various districts. They also illustrate the use of contours and color coding to depict areas above an authorized grade.

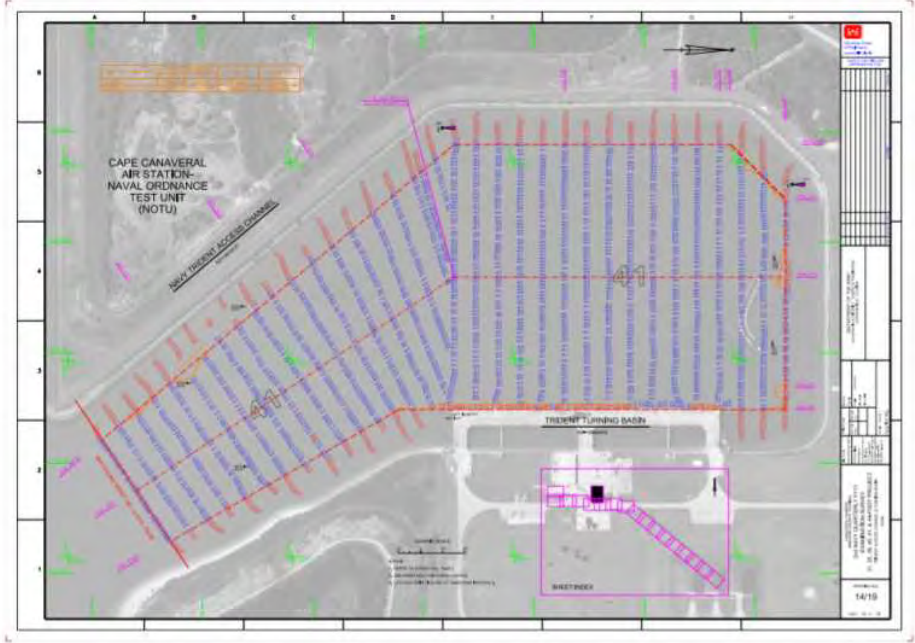

Figure 8-1. 2nd Quarter FY 2011 Jacksonville District condition survey of Cape Canaveral 41-ft project—Trident Turning Basin portion. Single beam cross-sections were run 100 ft c/c throughout project. Published drawing scale is 1 in. = 100 ft.

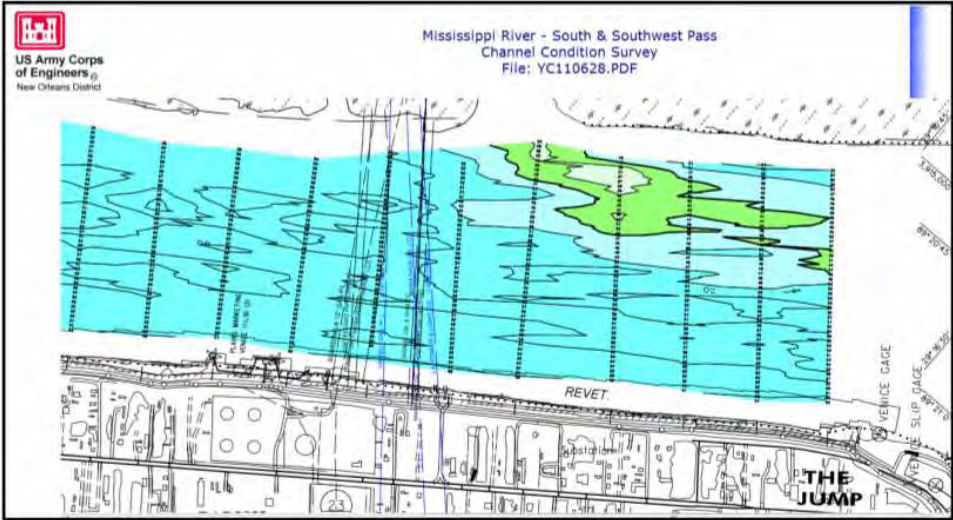

Figure 8-2. Portion of a New Orleans District daily (28 Jun 11) condition survey on the Mississippi River at Venice, LA. Single beam cross-sections spaced approximately 500 ft c/c. Color shaded contours depict regions above and below 50-ft project depth.

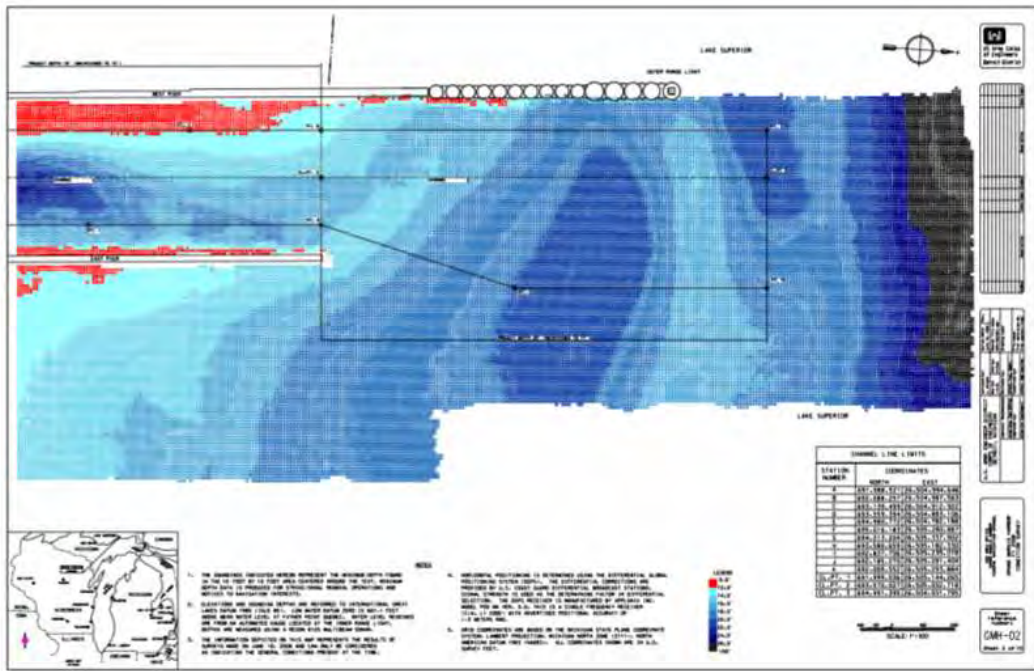

Figure 8-3. Detroit District (Soo Area Office) 2008 multibeam condition survey of Grand Marais Harbor on Lake Superior. Depths are plotted at a fine grid density (approximately 10-ft bins) with color shading to depict areas above the 20-ft project grade. Published drawing scale is 1 in = 100 ft.

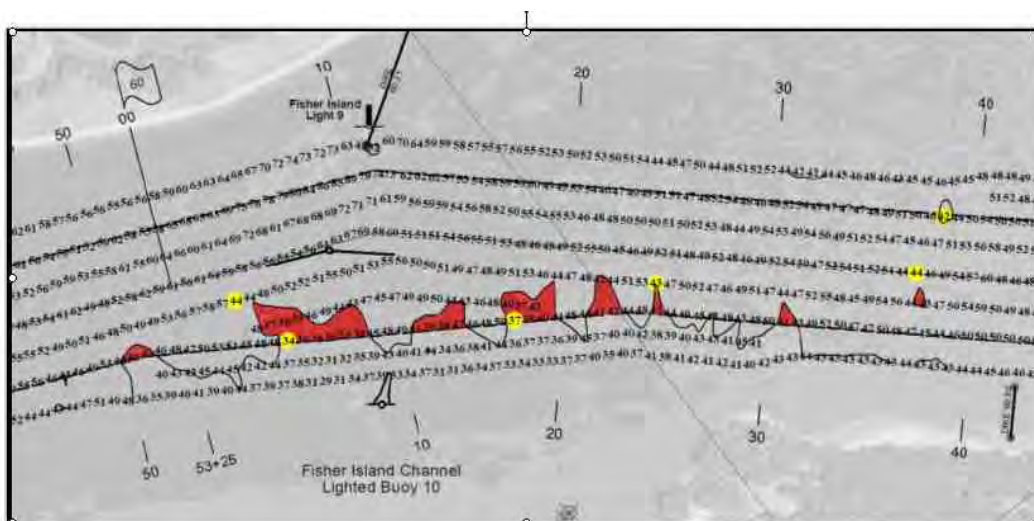

Figure 8-4. Portland District Project Condition Survey of portion of Fisher Island Channel in the Columbia River. Shoaling areas and controlling depths are highlighted. This drawing was produced from an ESRI GIS platform. (Note that soundings are rounded to the nearest even foot)

8-8. Feature Content and Digital Data File Standards. ER 1110-1-8156 directs that non-raster data developed by USACE must comply with (1) Architectural, Engineering, and Construction AEC/CAD Standards, (2) the Spatial Data Standards for Facilities, Infrastructure, and Environment (SDSFIE), and/or (3) the National CAD Standard. The SDSFIE includes a delineation of graphic elements and non-graphic attribute tables and domain lists describing these elements which are indexed into a schema or data dictionary. It also includes graphic symbology and other display and digital characteristics.

a. CADD and GIS standards. Project condition survey data should be collected, processed, and distributed in standardized vectorized formats, with individual feature CADD and/or GIS layers/levels that separate feature categories as much as possible. Text and annotation should also be separated by layers/features. Digital data should use the latest release of the AEC/CADD Standards—to include feature standards, formats, file standards, symbologies, etc.

b. Chart symbolization standards. NOAA has developed a feature symbology library that should be used as the Corps-wide standard for all navigation data products. This library is based directly on the IHO S-52 Standard for hydrographic data presentation—see IHO 2010.

c. S-57 Standard (IHO 2000). IHO Publication S-57 (S-57—IHO Transfer Standard for Digital Hydrographic Data) describes the standard to be used for the exchange of digital hydrographic data between national hydrographic offices and for its distribution to manufacturers, mariners and other data users. This standard is intended to be used for the supply of data for Electronic Chart Display and Information Systems (ECDIS) and/or Electronic Chart Systems (ECS).

d. Electronic data file type and format standards. USACE districts utilize CADD technology for the preparation, distribution, storage, and maintenance of engineering and architectural drawings, including navigation project condition survey data and related maps. Standardized file structures for these CADD platforms should be followed to simplify subsequent file conversion to the S-57 international nautical chart standard. These file structures include defined drawing file origins, units, naming conventions, sheet layout, level/layer assignments, symbology, exchange formats, etc. These standards are defined in the AEC CADD Standards.

e. GIS-based technology. Use of GIS software provides spatial relationships between all geographic features (entities); allowing for more enhanced data query, analysis, retrieval, and display than traditional CADD systems. Such files are more useful to vendors and are more suitable for conversion to the international S-57 charting standard.

8-9. Internet Posting of Project Condition Surveys. Most USACE districts post project condition survey data on the Internet for free public distribution. Periodic condition survey drawings can be uploaded to a district Web server; typically within a few days of receipt of field survey data. This provides near-real-time receipt of channel condition data by project users and federal agencies. USACE procedures for posting vector files and raster images have been

developed in each district in coordination and cooperation with NOAA. The USACE Navigation Data Center (Institute for Water Resources) Web site contains a comprehensive index of links to navigation data in 37 USACE districts.

a. File formats. Raster images can be posted in a format that is Web browser compatible—i.e., without need for plug-ins. These file formats may include PDF, CGM, JPEG, GeoTIFF, CRL, ECW, BSB, IGA, HMR, and IPLOT. Posted vector formats may include DGN, DXF, S-57, ESRI Shapefiles, VPF, or CARIS generated files. Many districts currently provide three or more raster or vector formats for each condition survey on their Web site—most commonly DXF, DGN, PDF, and JPEG. Basic X-Y-Z depth data may also be posted. Position and depth data should be shown to a resolution not exceeding 0.1 ft. It is recommended that districts begin to transition towards providing S-57 compatible data for coastal area navigation projects charted by NOAA. GIS compatible formats are also posted by some districts. HYPACK's "ENC Editor" software provides options for developing digital chart products suitable for Internet posting. CARIS (New Brunswick, Canada) has similar S-57 generating modules. (CARIS software is used to support the USACE IENC program in the inland waterways).

b. Metadata. A metadata file describing the geographic data file(s) content and format should be generated and placed on the Internet along with the appropriate links to the geographic data file(s). Metadata files should be generated following the guidance in EM 1110-1-2909, Geospatial Data and Systems.

c. Hard copy drawings. Districts should attempt to honor specific requests for hard copy paper drawings from agencies, sponsors, pilots, or individuals that cannot access the Internet or cannot print out large-format channel condition survey drawings.

8-10. Channel Framework Data. Coastal navigation projects should have defined channel framework parameters. A channel control framework is simply a digital 2D "plat" of a project's current (authorized) geospatial dimensions and alignments. Consistent channel framework data is essential in transferring surveys to other organizations, in particular, NOAA. It is also useful in maintaining archival geospatial data, as may be needed when comparing surveys from different eras. Channel framework data are normally maintained in CADD and/or GIS database files. Periodic channel condition surveys are surveyed and processed within this consistent channel framework. Mobile District is coordinating with NOAA to develop Corps-wide National Channel Framework standards within a GIS database structure. Additional details on channel framework requirements are attached at Appendix K.

8-11. Channel Condition Survey Drawing Notes. Following are examples of typical notes that should be included on framework files, and included for condition survey drawings that are incorporated into the framework file. Notes should be tailored to each project, sufficient to define the basic horizontal and vertical datums along with related field positioning criteria.

a. Horizontal Reference Datum & Coordinate System. The file should contain a general note that identifies the horizontal reference datum and its origin. Following is an example of a general note.

THE HORIZONTAL REFERENCE DATUM FOR THIS PROJECT IS NAD83, BASED ON THE CURRENT VERSION OF THE NOAA NATIONAL SPATIAL REFERENCE SYSTEM (NSRS). GRID COORDINATES ARE SHOWN IN THE [state] STATE PLANE COORDINATE SYSTEM [zone]. CHANNEL STATIONING AND OFFSETS ARE RELATIVE TO THE CHANNEL BASELINES. CHANNEL ALIGNMENTS ARE GRID BEARINGS REFERENCED TO THE SPCS GRID. UNLESS OTHERWISE INDICATED, CHANNEL WIDTHS AND LIMITS CONFORM TO THE AUTHORIZED PROJECT DIMENSIONS.

b. Primary horizontal control reference. A note should identify the primary reference PBM along with the positioning method employed on the project. On large projects, multiple PBMs may be needed and may be tabulated. An RTN network would be considered a “PBM” presuming it is based on the NSRS CORS network—a local calibration PBM should then be identified.

THE PRIMARY HORIZONTAL REFERENCE FOR THIS PROJECT IS NOAA/NSRS PBM "XXXXXX" (PID XX1234). DATA FOR THIS REFERENCE POINT SHALL BE OBTAINED FROM THE CURRENT NSRS DATABASE. THIS PBM SHALL BE USED FOR [RTK BASE APPLICATIONS] or [GPS/RTK/PPK/RTN POSITION CALIBRATIONS].

c. Vertical Reference Datum. A general note should specify the project datum, tidal epoch, and the primary reference gage.

THE VERTICAL REFERENCE DATUM FOR THIS PROJECT IS MEAN LOWER LOW WATER (MLLW) BASED ON NOAA TIDAL EPOCH 1983-2001. IT IS DEFINED RELATIVE TO PBM "TIDAL 123456 A 310" (NSRS PID XX1234).

In US coastal waters, MLLW datum shall be used exclusively. When a project legacy datum other than MLLW is used (e.g., MLW, NGVD29, MLG, LWRP), condition survey drawings will contain a vertical datum diagram showing the relationship between the particular local datum used and the MLLW (if tidal) and/or NAVD88 (if not tidal) datum—see EM 1110-2-6056. In the Great Lakes all project datums should be referred to IGLD (i.e., IGLD 85).

d. Vertical tidal datum model. Drawings should note the method which variations in the tidal datum are modeled at the project site relative to the primary reference gage. Options include a constant difference, interpolated model, hydrodynamically modeled, tidal zoning, or NOAA VDatum. In some cases a local tidal datum may be identified. Refer to EM 1110-2-6056 for details on tidal modeling and correction options.

EM 1110-2-1003
30 Nov 13

e. Survey accuracy estimates. If actual Performance Tests were conducted, then the resultant statistic (standard deviation) from that should be noted. If no test was performed, then an estimated accuracy (standard deviation) based on historical testing results may be noted. Alternatively, the estimated accuracy may reference meeting a standard tolerance in Table 3-1 of this manual. Optionally, condition surveys performed to meet an IHO standard may note that standard on the drawing.

THIS SURVEY WAS PERFORMED TO MEET THE TOLERANCES INDICATED IN TABLE 3-1 OF EM 1110-2-1003. PERFORMANCE TESTS [WERE] [WERE NOT] PERFORMED [add test details and results as appropriate].

THIS SURVEY WAS CONDUCTED TO MEET IHO [SPECIAL ORDER] [ORDER 1a] STANDARDS.

f. Miscellaneous notes. Other pertinent details from the "Survey Report" or other record should be added to the condition survey drawing/file notes. These may include items such as: survey methods, vessel, instrumentation, frequency, dates, personnel, calibration data, etc. It is recommended that the "Survey Report" be attached to the archived metadata file. This is advisable since often drawing file notes are often removed when condition surveys are converted to plans and specification surveys in bid documents.

8-12. Tabular Channel Condition and Controlling Depth Reports. A variety of formats are used to provide project condition surveys and reports to local marine interests and other federal agencies. Plan and profile drawing formats are most commonly used; however, other narrative or tabular methods may alternatively be used, as described in this section.

a. ER 1130-2-520 contains USACE policy that “applicable [commands] shall cooperate in the communication of navigation-related information of specific interest to the recreational and commercial marine industries, users, and other related government entities. Specific guidance is provided in EP 1130-2-520.” Detailed guidance for preparing tabular “Reports of Channel Conditions” is found in Chapter 2 of EP 1130-2-520. This engineer pamphlet specifies that “District commanders shall prepare channel survey/condition reports from the results of each controlled survey, using ENG Forms 4020-R and 4021-R prescribed in Appendixes B and C of EP 1130-2-520 for tabular reports. For coastal areas, a copy of the tabular reports and survey drawings/tracings will be forwarded within 60 days after completion to ...” Figures 8-5 to 8-7 are examples of tabular channel condition reports prepared by various districts. These reports may also be posted to district Web sites.

b. Tabular reports of controlling minimum depths in a channel reach are, in effect, large bins encompassing a wide breadth of the channel over its entire length. Reducing hundreds of thousands of recorded multibeam depths in this "bin" down to a single representative "minimum controlling" depth requires some type of standardized process. For example, in a 400-ft x 5,000-ft channel reach, the minimum depth shown for each channel quarter represents a 100-ft x 5,000-ft bin, or a 500,000 square foot area. A "shoal biased" depth selection option is typically selected

to represent the minimum depth over such a large reach. Unless the dataset is evaluated based on a "confirmed hit" type of analysis, a single anomalous and unrepresentative noise spike could end up being the falsely reported controlling depth for the entire channel reach. Reported controlling minimum depths should be truncated to the nearest whole foot, as shown in EP 1130-2-520. Channel Condition Reports are intended to report a minimum (safe) clearance depth based on the latest survey (Post Dredge, Project Condition, etc.). If an additional clearance "safety factor" is desired, then the representative depth could be rounded up to the nearest whole foot using the NOAA 0.7 ft truncation rule.

(1) Standards for "Reports of Channel Conditions." For assessing minimum clearances over an entire project reach "minimum confirmed" depths above grade should be used. Tabular reports of channel conditions should be generated similarly to those used for "strike" or clearance detection covered in Chapter 10 of this manual. Depths are normally binned from the edited dataset, using either 3 x 3 ft (hard material) or 5- x 5-ft (soft material) cell sizes. The "shoalest depth" of all depths in the cell is used as the representative depth for the cell; provided that there are a minimum of three (3) confirmed hits above project grade in the cell, or in an area between adjacent cells when the cells themselves are sparsely populated. The controlling minimum depth within a channel reach is then selected by analyzing all the cells in the given reach and selecting the individual cell with the minimum "confirmed" depth above grade. Automated software (e.g., HYPACK "Channel Condition Reporter") has been developed to perform this analysis over a channel reach.

(2) Plotting or tabulating only selected "minimum confirmed" depths on a Project Condition Survey that accompanies a tabular Report of Channel Conditions is a biased representation of the true project condition. Survey plots depicting only minimum (shoal-biased) depths should never be used for dredging plans and specifications or payment surveys since significant constant biases may be present. Plan drawings (or CADD files) of Project Condition Surveys should clearly note the depth selection option used.

c. Plan drawings and/or tabular reports of channel conditions furnished to other agencies should be prepared in accordance with the provisions of ER 1130-2-520 and EP 1130-2-520. Other significant requirements in this guidance includes (1) coordination and cooperation with the USCG on NAVAID location or relocation during design and construction, (2) USACE-maintained NAVAIDS, (3) requirements to furnish channel condition reports to the National Geospatial Agency (NGA), the US Naval Oceanographic Office (NAVOCEANO), NOAA, and the USCG, (4) required tabular formats for reporting controlling depths, (5) required grid systems, and (5) required plotting and tabulation of NAVAIDS located during the course of a survey.

8-13. HYPACK Channel Condition Reporter (CCR). A HYPACK utility program has been designed to quarter the channel along predefined reaches and tabulate minimum controlling depths along each reach and quarter. A variety of filters are provided, such as eliminating (footnoting) minimum depths near the toes. A DXF or DGN channel framework file is imported and quartering polylines defined for Outside Left, Inside Left, Channel Centerline, Inside Right,

EM 1110-2-1003
30 Nov 13

and Outside Right sectors. A Report of Channel Conditions is then automatically generated from the latest condition survey, as shown in Figures 8-8 and 8-9. Full details on running this utility package are outlined in HYPACK 2011.

31-Mar-11								
REPORT OF NAVIGATION CHANNELS								
ER 1130-2-306								
COLUMBIA RIVER - OREGON & WASHINGTON						Minimum depths in each 1/4 width of channel entering from seaward		
MOUTH THROUGH PILLAR ROCK LOWER RANGE (Sta 25.2)						Mid-Channel:		
Authorized Project NAME OF CHART Name of Channel (Mileage)	Date of Survey	Feet Width	Miles Length	Project Depth	Left Outside Quarter Feet	Left Inside Quarter Feet	Right Inside Quarter Feet	Right Outside Quarter Feet
MOUTH OF COLUMBIA RIVER	24-Mar-11							
Entrance Range (-2.5 - 0.8)		640	3.3	48	53	47	46	44
Sand Island Range (0.8 - 3.0)		2000	3.3	55	54	54	54	52
LOWER DESDEMONA SHOAL	01-Dec-10							
Lower Desdemona Shoal (3.0 - 6.4)		600	5.4	43	45	47	45	43
UPPER DESDEMONA SHOAL	24-Mar-11							
Upper Desdemona Shoal (6.4 - 10.0)		800	5.6	43	41	44	45	44
FLAVEL BAR	24-Feb-11							
Taney Point Turn & Range (10.0 - 13.6)		800	3.6	43	41	43	43	36
UPPER SANDS	23-Feb-11							
Taney Point Turn & Range (13.6 - 14.8)		800	1.2	43	41	44	45	44
Astoria Range (14.8 - 17.5)		600	2.7	43	43	44	44	43
TONGUE POINT CROSSING	22-Feb-11							
Tongue Point Channel (17.5 - 19.7)		600	2.2	43	40	43	44	42
Harrington Point Range (19.7 - 21.4)		600	1.7	43	41	42	42	37
MILLER SANDS	28-Feb-11							
Harrington Point Range (21.4 - 22.3)		600	0.9	43	43	44	45	36
Miller Sands Range (22.3 - 24.5)		600	2.2	43	42	45	44	41
Pillar Rock Lower Range (24.5 - 25.2)		600	0.7	43	42	45	44	43

ENG Form 4020-R (Nov 1990)
Reference is Navigation Chart No. 18521.
Note: Controlling Depths in Channels Entering from Seaward in feet at Mean Lower Low Water from the Entrance to Harrington Point and Columbia River Datum above that point.

Page 1

Figure 8-5. Tabular ENG FORM 4020-R (> 400 ft) channel condition report for the mouth of the Columbia River. (Portland District) Note that depths are rounded to the nearest even foot as required in EP 1130-2-520.

08-Mar-11							
REPORT OF NAVIGATION CHANNELS ER 1130-2-306							
COOS BAY - OREGON				Minimum depths channel entering from seaward			
Authorized Project NAME OF CHART Name of Channel (Mileage)	Date of Survey	Feet Width	Miles Length	Project Depth	Left Outside Quarter Feet	Mid-Channel for half project width Feet	Right Outside Quarter Feet
COOS BAY ENTRANCE	2-Feb-11						
Entrance Range (-1.0 - 0.9)			1.9	37	39	41	39
COOS BAY RANGES	21-Dec-10						
Entrance Range & Turn (0.9 - 1.7)		300	0.8	37	38	43	35
Coos Bay Inside Range (1.7 - 2.5)		300	0.8	37	35	38	35
Coos Bay Range (2.5 - 3.4)		300	0.9	37	36	37	37
COOS BAY AND EMPIRE RANGES	7-Dec-10						
Empire Range (3.4 - 5.7)		300-800	2.3	37	32	37	29

ENG Form 4021-R (Nov 1990)
 Reference is Navigation Chart No. 18487.
 NOTE All Depths refer to Mean Lower Low Water

Page 18

Figure 8-6. Tabular ENG FORM 4021-R (< 400 ft) channel condition report for Coos Bay Entrance Channel. (Portland District)

REPORT OF PREVAILING CHANNEL DIMENSIONS										
WILMINGTON HARBOR, NC SHIP CHANNEL US ARMY ENGINEER DISTRICT, WILMINGTON						MINIMUM DEPTH IN EACH 1/4 WIDTH OF CHANNEL ENTERING FROM SEAWARD				
NAME OF CHANNEL	MAP		PROJECT			-----				
	FILE NO. WH 105-	DATE SURVEY	FEET WIDTH	MILES LENGTH	FEET DEPTH	LEFT OUTSIDE QTR-FT	LEFT INSIDE QTR-FT	MID- CHANNEL	RIGHT INSIDE QTR-FT	RIGHT OUTSIDE QTR-FT
BALDHEAD SHOAL	89-20	03-89	500	4.54	40	33.5	35.5	37.0	37.0	32.5
SMITH ISLAND	89-18	03-89	500	0.98	40	24.0	36.5	42.0	41.5	39.5
BALDHEAD CASWELL CHANNEL	89-5	01-89	500	0.38	40	39.5	40.0	40.0	41.5	38.5
SOUTHPORT CHANNEL	89-8	01-89	500	1.02	40	42.5	43.5	41.5	42.0	37.5
BATTERY ISLAND CHANNEL	89-24	04-89	500	0.49	40	43.0	44.0	44.0	39.0	33.5
LOWER SWASH	89-19	03-89	400	1.60	38	33.5	40.0	40.0	40.5	34.0
SNOW MARSH	89-23	04-89	400	3.06	38	36.0	37.5	38.5	38.0	34.5
HORSESHOE SHOAL	89-25	04-89	400	1.22	38	31.5	38.0	38.0	38.0	38.0
REAVES POINT	89-26	04-89	400	1.17	38	35.0	38.0	38.5	38.0	37.0
LOWER MIDNIGHT	89-28	03-89	400	1.64	38	34.5	37.5	37.5	38.0	35.0
UPPER MIDNIGHT	89-22	03-89	400	2.69	38	37.0	38.0	38.0	38.0	35.5
LOWER LILLIPUT	89-29	04-89	400	1.94	38	36.5	37.0	37.0	36.5	36.0
UPPER LILLIPUT	89-31	04-89	400	1.94	38	36.0	36.5	38.0	36.5	37.0
KEG ISLAND	89-32	04-89	400	1.35	38	37.0	38.5	38.5	37.5	33.0
LOWER BIG ISLAND	89-35	04-89	400	0.76	38	36.0	38.5	38.0	37.0	29.0
UPPER BIG ISLAND	89-35	04-89	400	0.50	38	36.0	39.0	40.5	40.0	31.0
LOWER BRUNSWICK	89-34	04-89	400	1.64	38	19.5	39.0	39.5	38.5	35.0
UPPER BRUNSWICK	89-33	04-89	400	1.00	38	21.0	39.5	39.0	39.5	32.5
FOURTH EAST JETTY	89-30	04-89	400	1.24	38	36.0	40.0	39.5	40.0	38.5
BETWEEN CHANNEL	89-16	03-89	550	0.80	38	33.5	40.5	40.5	39.5	38.5
ANCHORAGE BASIN & APP CHANNEL	89-15	03-89	450-1090	1.30	38	36.0	38.0	38.5	37.0	35.5
BATTLESHIP TO HWY 74-76 BRG 32	88-18	02-88	300	0.62	32	26.5	35.5	36.5	36.0	34.5
HWY 133 TO BTLSP & TB 32'	89-1	01-88	890	0.00	32	27.0	28.0	31.5	30.5	25.0
HILTON BRG (ACL RR) TO HWY 133	88-20	03-88	300	0.00	32	30.0	31.5	32.5	33.0	29.0
NORTHEAST (CFR) ABV HILTON BRG	89-12	02-89	200	1.23	25	21.0	24.0	18.5	18.0	13.5

NOTE: DEPTHS ARE EXPRESSED TO THE NEAREST HALF-FOOT AND REFER TO LOCAL MEAN-LOW-WATER.

89

Figure 8-7. Tabular channel condition report for Wilmington Ship Canal (Wilmington District). Same information as reported on ENG FORM 4020-R except a mid-channel controlling depth is added to the report.

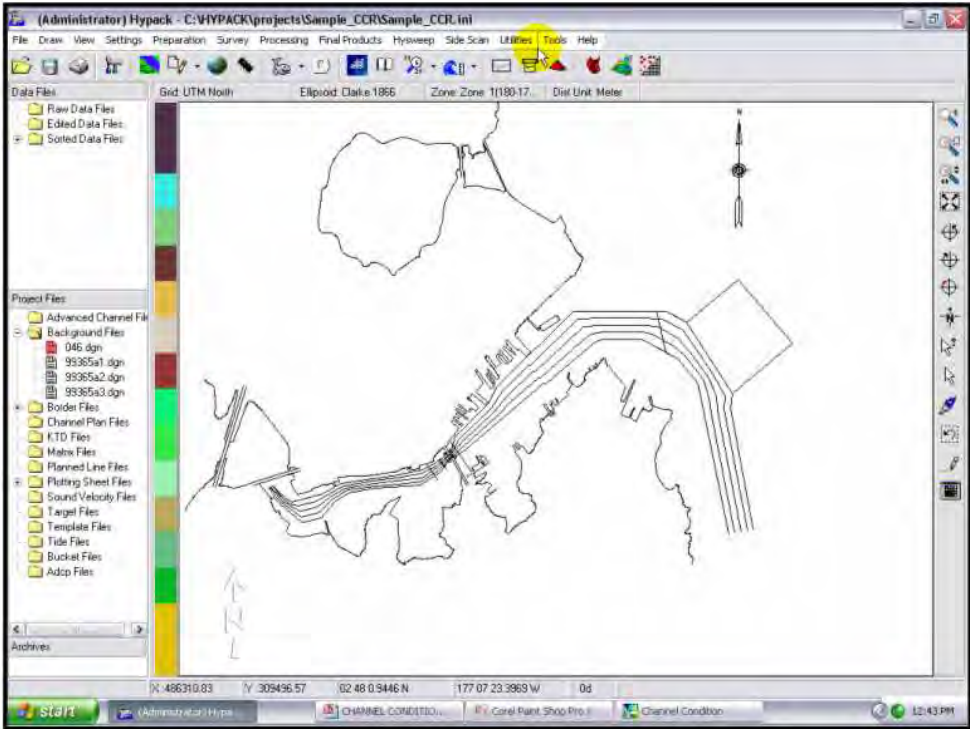

Figure 8-8. Setting up channel quarter polylines and reaches in HYPACK CCR. This utility was originally developed for New England District.

The screenshot shows the "Channel Report" window. The title bar reads "Channel Report". The window contains a "REPORT OF CHANNEL CONDITIONS" section with fields for "Four Quarter Channel", "TD:", "Portland Maine", and "U.S. Army Engineer District, New England". Below this is a table with columns for "NAME OF CHANNEL", "Date of Survey", "Authorized Project", "WIDTH (feet)", "LENGTH N.Miles", and "DEPTH(S) AVAILABLE". The table lists five channels (R-5 to R-9) with their respective survey dates, widths, lengths, and depths. To the right of the table are buttons for "Printer", "Close", "Font", "Export Xcel", "Add Row", "Insert Row", and "Delete Row". Below the table is a "FOOT NOTES" section with two notes: (1) Shoaling to 29.30 within 1' of Left limit and (2) Shoaling to 28.10 within 2' of Right limit.

NAME OF CHANNEL	Date of Survey	Authorized Project	WIDTH (feet)	LENGTH N.Miles	DEPTH(S) AVAILABLE
R-5	1/1/2001	1342.66	0.47	34.00	25.30 34.00 34.00 34.00
R-6	1/1/2001	1423.51	0.28	34.00	31.60 32.70 34.00 32.40
R-7	1/1/2001	1333.32	0.37	34.00	32.00 (1) 34.00 33.40 34.00 (1)
R-8	1/1/2001	1072.48	0.37	34.00	29.90 34.00 34.00 30.00
R-9	1/1/2001	675.65	0.37	34.00	12.30 34.00 34.00 17.90

FOOT NOTES
 (1) Shoaling to 29.30 within 1' of Left limit
 (2) Shoaling to 28.10 within 2' of Right limit

Figure 8-9. Automated HYPACK CCR report generation for a four-quartered channel.

EM 1110-2-1003
30 Nov 13

THIS PAGE INTENTIONALLY LEFT BLANK

CHAPTER 9

Surveys of Navigable Inland Rivers, Locks and Dams, River Stabilization Structures, and Reservoir Surveys

This chapter describes hydrographic survey procedures used in support of the Corps inland navigation, water control, and river engineering missions. These activities include survey support for inland charts, hydrologic and hydraulic studies, investigation of river stabilization structures, scour surveys around bridges, locks, and dams, reservoir surveys, and other investigations needed to model physical aspects of river stabilization systems. General guidance on these surveys is detailed in this chapter and in attached appendices. The Atlantic Intracoastal and Gulf Intracoastal waterway systems are covered under coastal projects in Chapter 8.

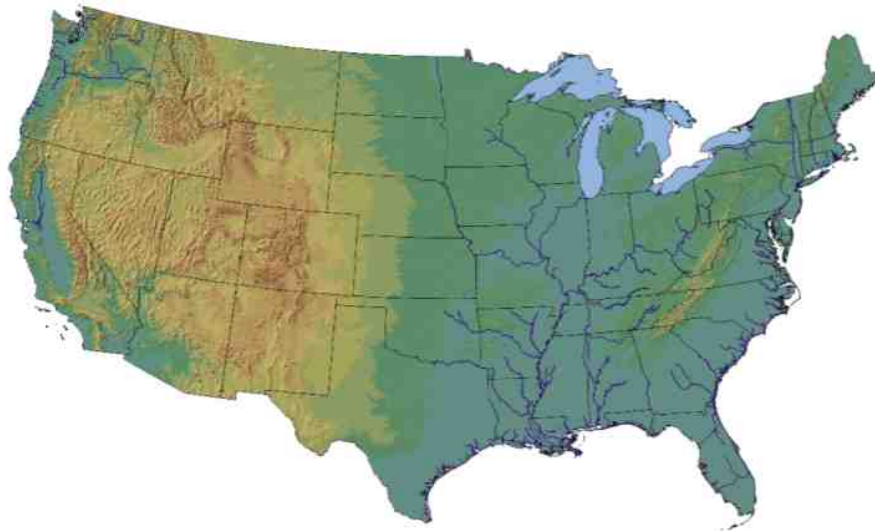

Figure 9-1. Corps inland navigation systems shown in blue. Includes various navigable inland tributaries connecting to the main stems of the Mississippi, Ohio, and Missouri Rivers. In Mobile District, the Tenn-Tom, Black Warrior, and Alabama River. Out west, the Columbia, Snake, and Sacramento River systems.

9-1. General Applications. The Corps performs a variety of hydrographic surveys throughout its inland navigation system (Figure 9-1). Many of these surveys involve underwater mapping and investigation of channel reaches, for the purpose of locating clear passages or shoaled areas requiring maintenance dredging. Hydrographic surveys are also performed in reservoirs and pools around many the Corps 692 dams and hydropower facilities. Surveys supporting hydraulic studies are also performed, measuring channel and overbank profile topography, current velocities, and flow directions; from which flood profiles and flood protection elevations may be estimated. Other survey applications include obtaining source data for inland navigation charts

produced by the various inland districts. These include traditional hard-copy chart books and electronic charting formats (e.g., IENC). Inland river surveys also include developing basic site data for specific localized projects such as river crossings, cutoffs, and bends, sediment movement and deposition, scour in bends, channel stabilization structures, and training structures such as spur dikes, longitudinal dikes, vane dikes, and closure dikes. Detailed hydrographic surveys are also performed around navigation lock approaches, guide walls, guard walls, lock walls, and adjacent dams. Such surveys are used for planning and design of maintenance or improvements to these structures.

9-2. Survey Equipment, Vessels, and Methods. Due to the variety of projects surveyed on inland navigation and water control systems, different hydrographic survey systems are used. In shallow draft projects (<15 ft) single beam systems are most commonly used. In the Middle and Upper Mississippi districts, multiple transducer boom systems are used. In deeper portions of a river (Lower Mississippi, bends, etc) multibeam systems are deployed. Multibeam surveys are also used in condition surveys of revetments, locks, dams, and various river control structures.

a. Survey vessels. Survey vessels on inland projects are usually less than 30 ft in length, 22-ft to 28-ft aluminum workboats being a common length. These trailerable size workboats allow for deployment along the major waterways and inland reservoirs. Various hull types are used: V-hull, cathedral (tri-hull), catamaran, etc. The selected hull type is often based on the mounting requirements for a multibeam transducer. Stability is also a hull selection factor. Power train (inboard, outboard, or inboard/outboard) and fuel types (gasoline or diesel) are dependent on local district preferences. Enclosed cabins are usually specially designed about the intended survey systems that will be installed.

(1) St. Louis District MV Boyer. The Mississippi Valley Division (St. Louis District) MV Boyer is typical of boats used for river engineering surveys and investigations on the Upper, Middle, and Lower Mississippi River, and the Ohio and Missouri Rivers. This 30-ft vessel (Figure 9-2) is equipped with twin 250 HP Yamaha outboards. This trailerable vessel with single beam, multibeam, acoustic doppler current profiling, bottom and fish classification, and side scan capabilities, has the ability to map underwater features of most flood control and river stabilization structures in the Mississippi Valley Division. Its on board data processing equipment provides a "field-finish" capability, enabling same- or next-day delivery of edited data sets to districts in the Mississippi Valley Division.

(2) Louisville District survey boats. Figure 9-3 depicts the various survey boats deployed by Louisville District on their Ohio River navigation projects. These trailerable, cathedral (tri-hull) boats have single/twin 135 HP outboard engines on the 23-ft survey vessels, and twin 225 HP on the 30-ft survey vessel. All three are equipped with single beam echo sounders, USCG Marine Radiobeacon DGPS positioning, RTK positioning, and motion sensors. The 30 ft vessel is a landing craft with a moon pool deployment for a Reson 8125-H multibeam system. The single beam boats are used for channel condition surveys, chart updating, and dredge support surveys. The multibeam survey boat is used to monitor scouring around structures, investigative surveys, and environmental mapping.



Figure 9-2. MV Boyer (St. Louis District)--used for river engineering surveys and investigations on the Middle and Lower Mississippi River.



Figure 9-3. 23-ft and 30-ft survey boats used on the Ohio River. (Louisville District)

b. Positioning and orientation systems. DGPS code phase horizontal positioning is adequate for most inland navigation surveys. Coverage can be obtained from the USCG Radiobeacon System or from commercial providers. Inertial orientation or heave sensing is rarely required for single beam or multiple transducer systems on normally calm inland waterways. Inertial heave-pitch-roll sensors (MRUs/IMUs) are required for multibeam systems. Inertial-aided GPS systems (e.g., POS/MV or F180 series) are used on some vessels. Carrier

phase GPS is recommended to control precise surveys of locks and dams--both horizontally and vertically--where 0.1-ft positioning and elevation resolution is required.

c. Vertical reference datum. Inland surveys are referenced to either the NSRS (i.e., NAVD88) and/or a local low water reference datum (e.g., LWRP, pool, reservoir). In some cases, an undefined (unreferenced) legacy vertical datum may be used. The relationship between any local or legacy datum to the NSRS must be established—see ER 1110-2-8160, Policies for Referencing Project Elevation Grades to Nationwide Vertical Datums. When inland river surveys are interpolated or extrapolated from gages 10 miles or more distant, the uncertainty of the low water reference datum at the project site may be large—often ± 1 ft or more. This uncertainty must be factored into the estimated uncertainty of reported depths. Use of carrier phase RTK elevation measurements will help minimize these uncertainties. (Refer to EM 1110-2-6056 for descriptions of hydraulic datums used on USACE inland civil works projects.)

d. Single beam survey coverage methods. For most navigation, hydraulic, or physical modeling applications, single beam cross sections are run at a defined spacing. The spacing will be a function of the engineering detail required, and could range from 100 ft to 500 ft, or more on some general studies. Cross-section spacing will be reduced near lock approaches and other control structures. Cross sections are run perpendicular to the river flow and typically cover bank to bank. Dredging progress surveys are typically run at 100-ft cross-section intervals, channel condition surveys run at 200 ft sections, and IENC condition surveys at 200- to 400-ft spacing.

e. Multibeam and multiple transducer survey coverage methods. Multibeam surveys are usually only performed in deeper river sections—i.e., > 15 -ft depths. Multibeam surveys are normally run upstream and downstream, "painting" the bottom with 100% acoustic coverage. Downstream runs in swift currents may result in along-track voids; necessitating only upstream runs against the current. Multibeam transducers may be physically or electronically "tilted" to port or starboard, providing coverage up to the water's edge on banks or revetments.

f. Topographic surveys. Not all river control or stabilization structures are fully submerged, requiring combined hydrographic and topographic survey methods. Fully submerged structures can be mapped using all the acoustic techniques described above, i.e., single beam, multiple transducer, multibeam, and optionally, side scan sonar. A variety of topographic methods may be used to obtain coverage on structures, revetments, or levees above water. Laser scanners (static and dynamic), aerial mapping, and traditional total stations are the most common methods. Topographic data are merged with hydrography to form a continuous model.

g. Recommended accuracies, QC, and QA criteria. Nominal accuracies and related performance standards for inland surveys are summarized in Tables 9-1 and 9-2 at the end of this chapter.

9-3. Inland River Charting Surveys. This section represents a brief overview on inland surveys that are utilized to update navigation charts, hydrographic books, reservoir maps, and related

products published by USACE districts and furnished to waterway users and the general public. Much of the guidance in Chapter 8 for coastal project condition surveys is also applicable to inland surveys.

a. Inland navigation chart products. On the inland waterway systems, USACE-published chart books are produced and distributed to the public in a variety of formats, symbology, scales, and electronic media; in accordance with the recommended guidance currently provided in EP 1130-2-520, Navigation and Dredging Operations and Maintenance Guidance and Procedures, for these products. Currently, hard-copy formats vary between USACE districts and/or waterways (Figure 9-4). Paper chart standards have been developed. The electronic version of all inland navigational charts is produced by the Inland Electronic Navigational Chart program, coordinated by the USACE Army Geospatial Center (AGC), and with production from the USACE Louisville District. These electronic charts are processed using Caris software. An index of these electronic charts can be found at the AGC website.

b. Accuracy standards for measured depths. Recommended accuracy standards for inland federal navigation projects are outlined in Table 9-1. In areas with high shoaling rates, rapid sand wave movement, or distant from river gages, these recommended standards will usually not be met. In such cases, an estimated accuracy (or uncertainty) should be clearly reported (noted) on drawings. Surveys near river control structures with established gages should easily be well within these nominal accuracy standards.

c. Accuracy standards for horizontal chart features. Planimetric navigation features on inland projects should be positioned to an accuracy of ± 6 ft at the 95% confidence level. This standard is relative to the NSRS. This feature accuracy tolerance falls within the average accuracy of typical GPS receivers using the USCG/USACE maritime DGPS radio beacon network along the inland waterways. A minimum base map compilation scale of 1 inch = 400 ft is recommended for topographic/planimetric features critical to maritime DGPS referenced navigation. Scales larger than this (e.g., 1 inch = 50 ft to 200 ft) may be used in/around critical navigation features--e.g., locks, dams, bridges. Some critical navigation features may need to be located to a higher accuracy using conventional topographic survey methods. These features might include fixed navigation aids, lock chambers and lock approach walls, bridge piers/fenders, etc. Short-term static positions with maritime DGPS may provide sufficient accuracy for these critical features. Otherwise, RTK positions from a local base station or RTN will suffice. Existing as-built drawings may also be used if geographically referenced to the NSRS. Refer to EM 1110-2-6056 for additional details on locating project features relative to the NSRS.

d. Requirements for depth data on inland navigation chart products. Depth data obtained from periodic channel condition surveys may occasionally be shown on inland navigation charts, often at critical bends or lock approaches. However, some navigation charts published by USACE districts depict only topography and planimetry. This lack of depth data on the chart is due to a variety of reasons; one of which is rapid (daily or even hourly) large bathymetric changes on many river systems. As a result, depth data is quickly obsolete for charts published on a 2- to 10+-year cycle; therefore, these products do not show depths curves. "Hydro Books"

published by some Mississippi Valley Division districts contain subsurface bathymetric data. IENCs show a depth contour representing project depth or deeper from MLLW or Low Pool. The IENCs are in a monthly update cycle so the latest survey depth data can be made accessible to the navigation community. Print-on-Demand (POD) capability is entering mainstream. The USACE 2012 Atchafalaya River Navigation Folio is the first USACE charting publication maintained under print on demand. In POD, new up-to-date versions of the folio can be readily produced. This mechanism can allow for publication and maintenance of safe water depth contours.

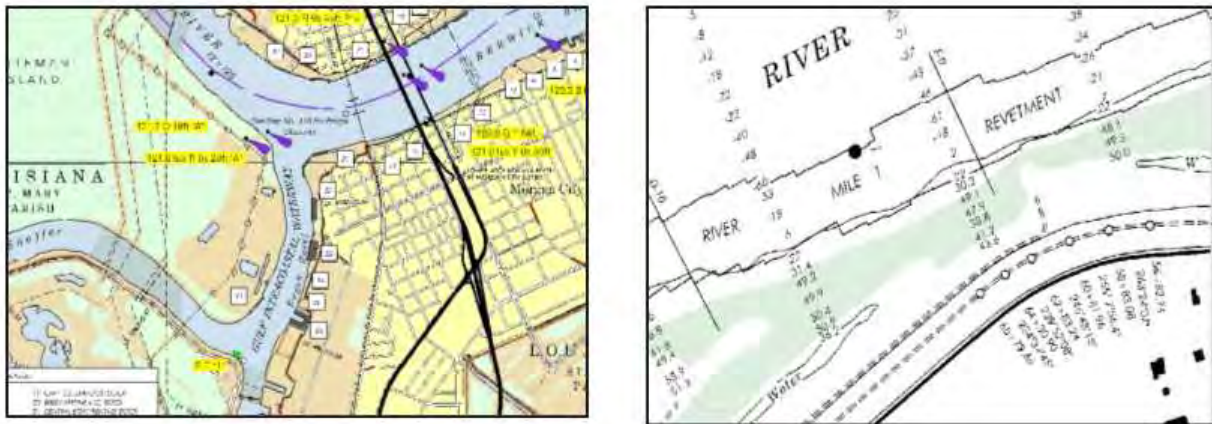

Figure 9-4. (left) Portion of Atchafalaya River navigation chart--Morgan City, LA area. Depth data is not shown on this navigation chart. (right) Portion of Atchafalaya River Hydro Book--Atchafalaya River Mile 1 Revetment. Cross-section bathymetry and overbank data shown.

e. Horizontal chart datum standards. All charts and engineering drawings of USACE inland navigation projects should be horizontally referenced to the NSRS—e.g., NAD83 and the GRS80 reference ellipsoid. Navigation projects still referenced to NAD27 should be transformed to NAD83. SPCS, Chainage-Offset, and River Mile coordinates systems should be included on all products where applicable.

f. Depth selection. Displayed depths on hard-copy charts must be thinned as a function of the engineering drawing or chart scale. Densely acquired hydrographic depth data—e.g., that collected from acoustic multi-transducer or multibeam systems—should be thinned to a bin size (or post spacing) consistent with the largest display scale use of the data. The recommended procedures and software used for such data thinning/binning are covered in Chapter 6 in this manual.

9-4. River Lock and Dam Investigation Surveys. Periodic investigation surveys are performed around river locks and dams (Figure 9-5). These surveys monitor shoaling and scour near the locks, the lock approaches, and adjacent underwater structures. Multibeam surveys provide the best detail in these river structures. In particular, multibeam surveys can identify scour occurring

downstream of gate structures. These surveys can quickly identify potential failure points where further investigation by divers or underwater cameras is required. These surveys require the most demanding QC and QA methods in order to minimize uncertainties in the measurements.



Figure 9-5. Typical inland lock and dam complex (Robert. C. Byrd Locks & Dam at Ohio River Mile 279.2—Gallipolis Ferry, WV—Huntington District). Detailed multibeam surveys are performed at the lock approaches, and upstream/downstream of the gates.

a. Control. Detailed investigation surveys of locks and dams should be controlled using RTK or RTN carrier phase positioning, with attainable X-Y-Z accuracies at $<\pm 0.2$ ft. Usually a RTK base station is set up over a local benchmark at the lock. The horizontal coordinate system should be referenced to that established on as-built drawings for the lock—either SPCS or a legacy local coordinate system.

b. Reference gage. Most USACE inland lock and dam complexes have two established gages—an upstream gage and a downstream gage. These gages are hydraulically referenced to their respective pools and a local datum established for each pool. RTK surveys should be referenced (calibrated) to these gages and their local pool reference datum.

c. Survey procedures. Multibeam surveys are performed "dead slow" in and around the lock and dams—sometimes drifting over the site against the current. Repeated passes are made over potential scour areas below the gates. Wicket dams are surveyed at high water—they have too much noise in the water at low pool. Surveys of dams are best made during rising water since at high crests the turbulence creates dangerous conditions for the survey boat. Sufficient

redundant data should be collected to ensure the edited data in each 1-ft x 1-ft cell (typical) will be statistically representative of the site. Considerable editing may be required for data collected around structures.

d. Calibration. Multibeam Performance Tests may be made in the lock chamber. "RTK Tide" vertical elevation measurements should be calibrated at the lock pool gages.

e. Application examples. Examples of lock and dam investigation surveys at various USACE projects are shown in Appendix N. Appendix M, "2010 Allegheny River Multibeam/Side Scan Sonar Scour Survey," is a comprehensive report covering surveys of four locks and dams in Pittsburgh District.

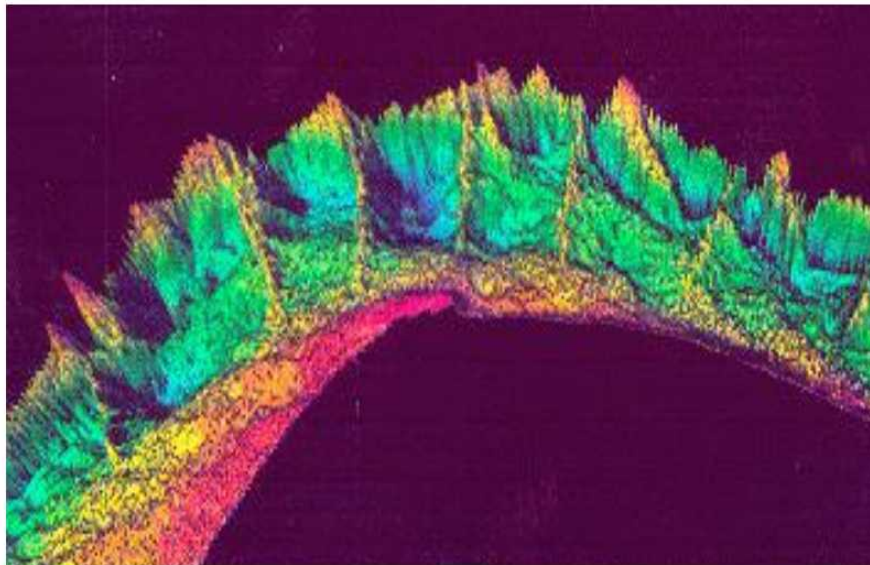

Figure 9-6. Multibeam survey of bendway weirs. This survey was performed in the mid-1990s with the first multibeam systems—newer multibeam systems have significantly better resolution. This coarser resolution in the 1990s was still far better than that obtainable from previous single beam surveys of the weirs. (St. Louis District)

9-5. River Stabilization Structure Surveys. Figure 9-6 is an example of a multibeam system survey over a series of bendway weirs on a bend in the Mississippi River. Periodic surveys can be performed to monitor sediment erosion and deposition in the bends and adjacent to the weirs.

9-6. Underwater Structure and Revetment Surveys. Multibeam transducers can be tilted upward to detail revetments, bridge piers, fenders, pilings, lock guide walls, breakwaters, jetties, and other structures. Depth coverage up to near the water's edge is often possible. In deeper water, coverage under moored barges along a riverbank is feasible. Revetment grading, construction, and maintenance projects require a variety of surveys. During placement of articulated concrete mats, control surveys are needed to accurately align the sinking plant equipment. Subsequent

hydrographic condition multibeam surveys are periodically performed to assess the condition of the concrete mats for needed replacement. The sketch at Figure 9-7 illustrates side viewing multibeam coverage on a riprap embankment. These surveys should be performed to a higher level of accuracy than that recommended for general river navigation surveys. Use of carrier phase RTK is recommended. Selected examples of underwater structure surveys are attached at Appendix N.

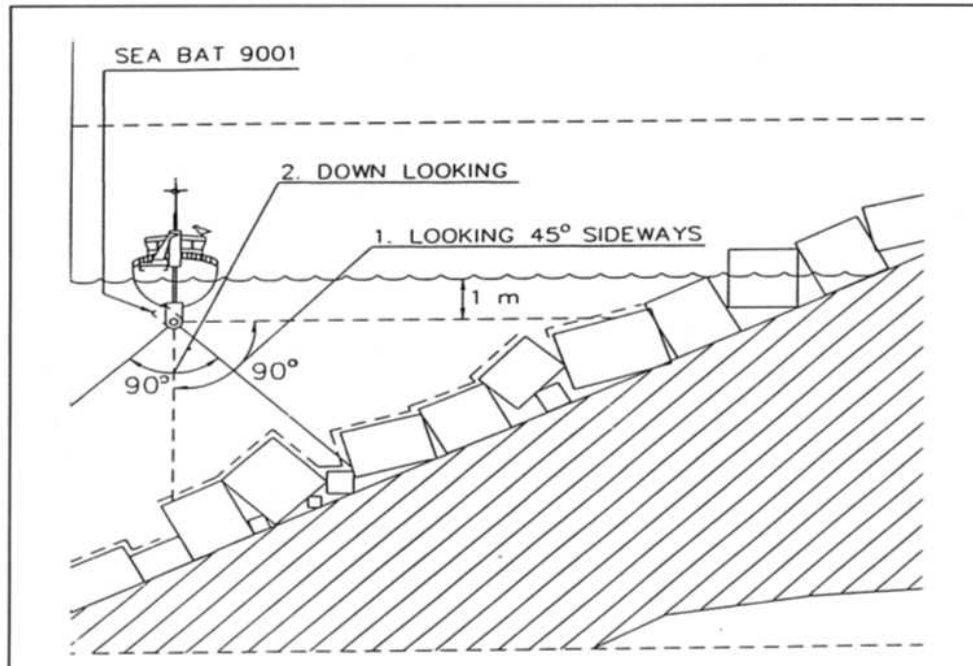

Figure 9-7. Tilting multibeam transducer head for surveying river revetments and other vertical structures. (Reson, Inc.)

9-7. Levee Breach Surveys. Figure 9-8 illustrates the use of multibeam systems during the Mississippi River Flood of 1993. This plot is an example of the first use of multibeam technology in the Corps—JE Chance (now Fugro) obtained the first system and it was deployed during the 1993 emergency flood fight. During high water stages in which levees were overtopped, breaches were located and mapped, allowing repair estimates to be made. Figure 9-8 also depicts a multibeam survey performed over Lock and Dam 25 when much of the structure was covered during high water.

9-8. Mississippi River Sand Wave Mapping. Multibeam systems can be used to track the downstream movement of sand on a river. These large amplitude sand waves found on the Mississippi River have a relatively high downstream velocity, as shown in Figures 9-9 and 9-10. Thus, any mapping survey of depths in these regions is only valid for the time (hour) of the survey, given depths can differ by 10 ft or more a day later.

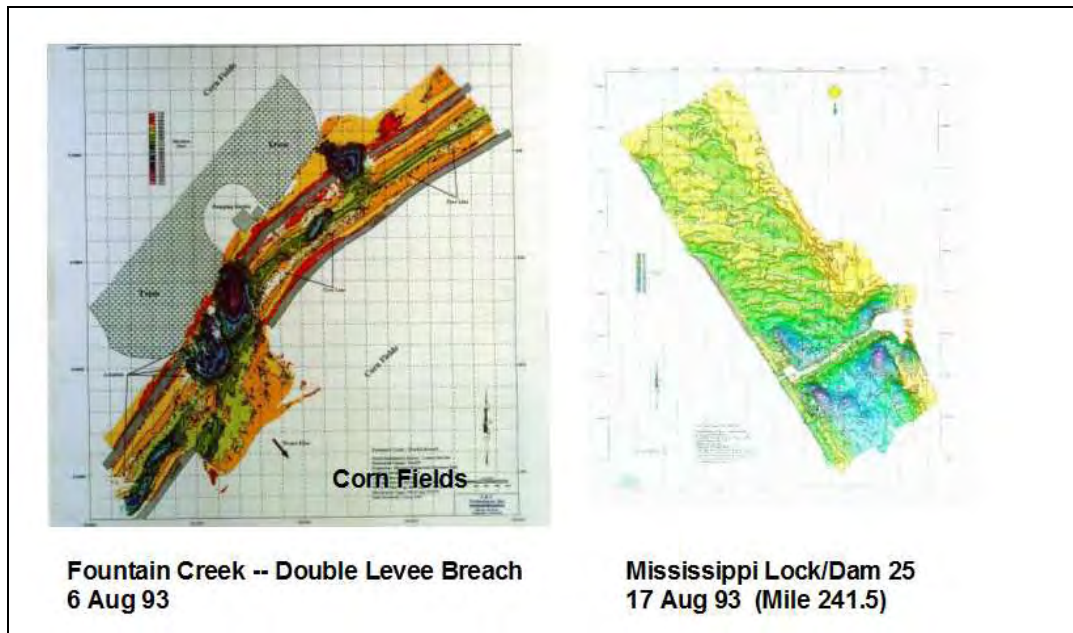

Figure 9-8. Levee breach and lock & dam surveys during high water. Flood of 1993, Mississippi River. (JE Chance & Associates for St. Louis District)

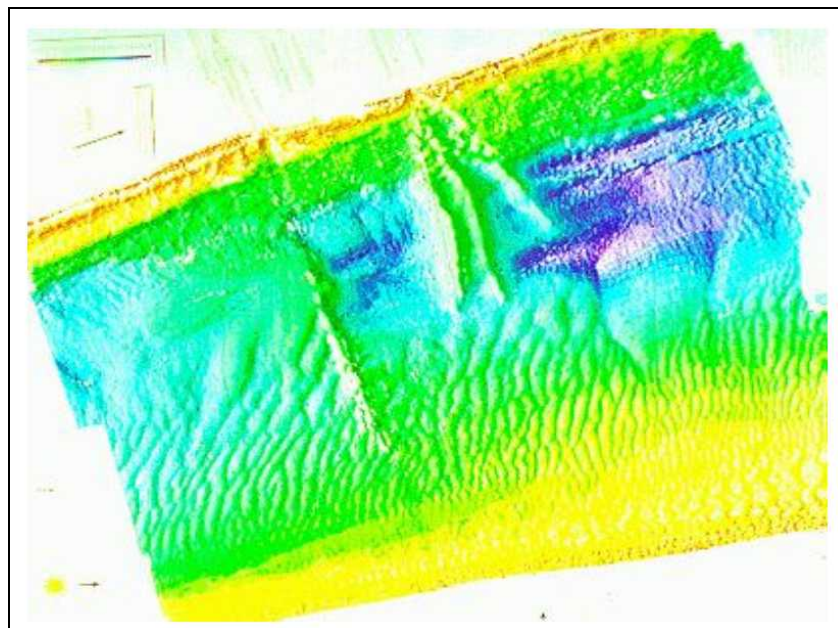

Figure 9-9. Lower Mississippi River sand wave features from multibeam survey.

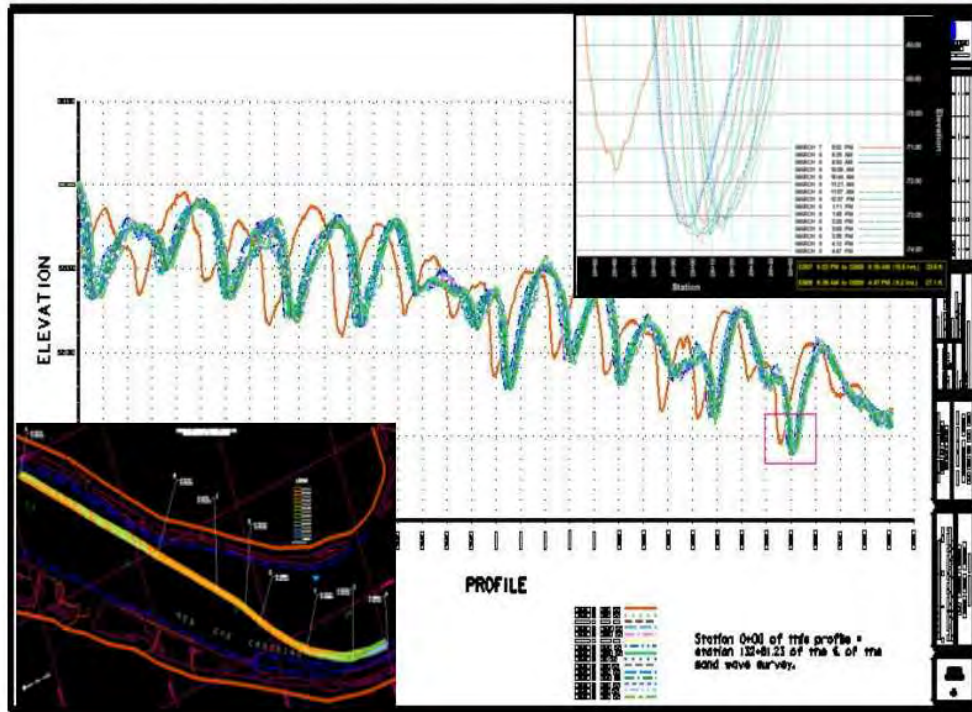

Figure 9-10. Sand wave progression at Red Eye Crossing, Mississippi River. 15-ft sand waves moving downstream at roughly 2 ft per hour.

SECTION I

Hydrographic Surveys for River Hydraulics Studies

9-9. **Background.** River hydraulic investigations and studies include the evaluations of flow characteristics and physical behavior of rivers--e.g., prediction of stage, discharge, velocity, and sediment transport rates. Basic hydrographic survey data is a critical component of these studies. Other hydraulic studies requiring field survey support may involve topographic details on dams, spillways, levees, and floodwalls. Hydrographic, topographic, and/or photogrammetric surveys may be required to support hydraulic modeling of floodplains, flood control channel design, navigation modeling, water quality assessment, and environmental impact and assessment analysis. Survey data is incorporated into physical and numerical hydraulic models used for analyzing or predicting the physical processes of a river system.

a. **Hydraulic engineering studies.** A variety of hydrologic engineering studies require hydrographic survey support to define the basic topographic models of river systems. These may include steady flow water surface profiles, unsteady flow simulation, sediment transport modeling, flood inundation modeling, hydraulic flood stage modeling and forecasting, flood inundation modeling and mapping, and flood damage risk assessment. Hydraulic studies typically require three general data categories: (1) discharge, (2) geometry, and (3) sediment. Hydrographic surveyors may be called upon to obtain basic field information for any of these

three categories. Obtaining stream section and adjoining bank and floodplain geometry requires a major amount of field survey effort.

b. Channel Geometry. Channel geometry derived from hydrographic surveys is required for any hydraulic study. Geometric data include channel and overbank topography, stream alignment, bridge and culvert data, channel roughness information, changes in stream cross-section shape or channel alignment. Hydrographic, photogrammetric, and conventional topographic surveys may be required to fully define a streambed, adjacent banks and floodplains. For movable bed studies, repeat surveys may be needed to evaluate a model's performance in reproducing geometric changes. Thalweg profiles or repetitive hydrographic surveys may be needed for analysis of bed forms and the movement of sand waves through rivers.

c. Discharge studies. Flood control projects are usually designed for the discharge corresponding to a specific flood frequency (design event) while navigation studies use a discharge for a specific low flow duration or frequency. Discharge data may include measured flows along with frequency, velocity, duration, and depth information. Surface profile elevations are also measured during flood events as an aid in flood routing studies. Water depth and channel cross-section profile are critical components in computing or predicting discharges. Acoustic Doppler Current Profilers (ADCP) are used to measure currents for determining discharge rates -- Figure 9-11.

9-10. Cross-Sections for Hydraulic Studies. Cross-section data are used to determine the conveyance and storage of a river channel and overbank areas. Stream section requirements are defined by the hydraulic engineer or study manager. Required cross-sections are typically plotted on a small-scale map (e.g., USGS quadrangle) of the study area. Cross-section spacing will vary depending on many hydraulic factors associated with the purpose of the hydraulic study. They must be obtained at sufficient intervals to define the flow carrying capacity of the stream and its adjacent floodplain, and at locations where changes occur in discharge, slope, shape, roughness, at locations where levees begin and end, and at hydraulic structures (bridges, weirs, and culverts)--see example layout at Figure 9-12. The type of hydraulic model (e.g., unsteady flow or steady flow) may also dictate cross-section locations. On the Mississippi River system, cross-section spacing varies from 500 ft to 5,000 ft. The width of the section depends on the extent of the floodplain (if any), existence of levees, and other factors. Some cross-sections may be run bank-to-bank in the river with overbank topographic sections run to the top of a levee and into the floodplain. If extensive flood inundation studies are involved, then the cross-section may be extended far out into the floodplain--to the so-called "bluff" line where maximum flood stages would be limited. These lines could extend significant distances on some river systems--5 to 10 miles or more.

a. Mixed survey methods. Obtaining cross-sections of floodplain basins requires a combination of survey methods. Hydrographic surveys performed in the river must be supplemented by conventional surveys in the overbank and flood plain areas. Surveys of the floodplains are usually more efficiently performed using aerial mapping methods, whereby a gridded digital elevation model (DEM) is created using airborne LIDAR or photogrammetric

methods. Airborne methods are limited by vegetation cover, which is usually dense along river banks. Conventional topographic survey methods (e.g., differential leveling, total station, RTK) will be required to develop obscured areas near riverbanks and to set breaklines in the final terrain model.

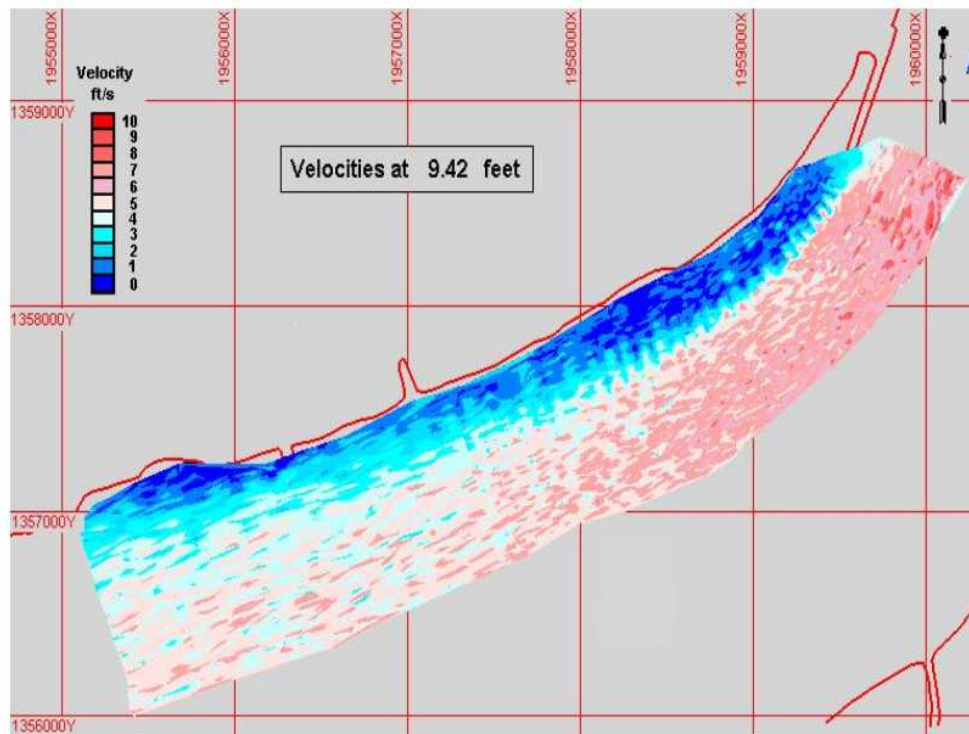

Figure 9-11. ADCP current velocities on the Mississippi River. Velocities shown are processed at 9.4 ft below surface. Surveys were performed using RD Instruments 600 kHz and 1200 kHz ADCP and WinRiver Current Profile Acquisition Software. (St. Louis District)

b. Digital elevation models. Since a variety of survey methods are used to obtain cross-sections, it is important that these independent data sets be accurately consolidated into a database from which cross-sections are generated. The hydrographic cross-sections are typically run over finite lines, as are topographic overbank sections and breaklines. The photogrammetric (LIDAR) DEM, however, is typically obtained at a prescribed grid interval (i.e., "post" spacing). The accuracy of these data sets also varies. The topographic survey elevations may be accurate to ± 0.2 ft, the hydrographic surveys to ± 0.5 ft, and the photogrammetric DEM to only ± 1 ft.

c. Digital terrain model. Typically, the hydrographic, topographic, and photogrammetric DEM data sets of the river, banks, levees, and floodplains are combined into a continuous digital terrain model (DTM) in a CADD or GIS database (e.g., design files, Arc-Info). Using this DTM, hydraulic cross-sections are cut at the prescribed orientations--based on the hydrographic cross-section alignment. If full-bottom hydrographic coverage was obtained using multiple transducer

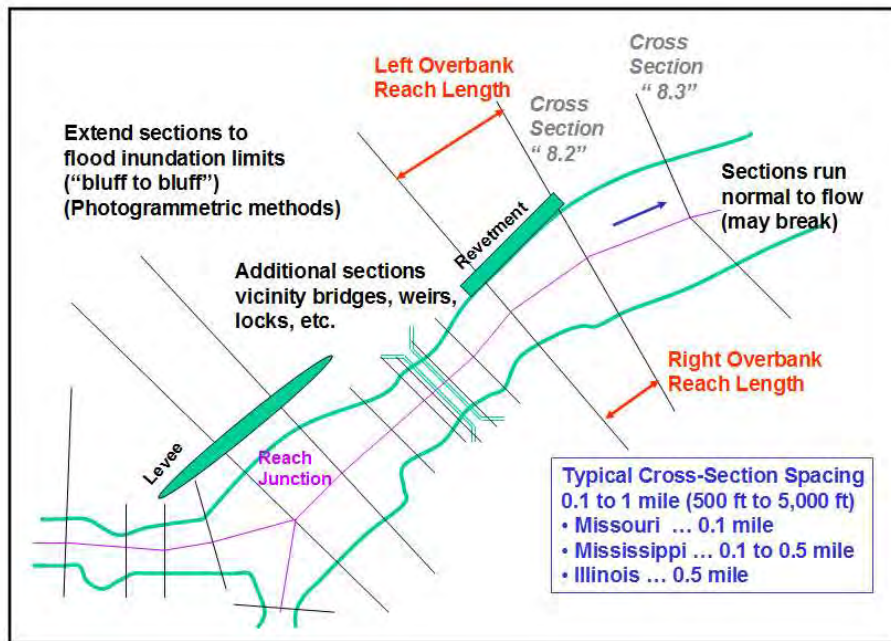

Figure 9-12. Typical cross-section configurations for a HEC-RAS hydraulic model.

or multibeam methods, then more flexibility is available in selecting cross-section alignments and locations for the hydraulic model. If a full, dense, DTM of hydrographic and topographic coverage is available, then an unlimited number of hydraulic cross-sections are available--at any desired alignment or spacing. The following mapping specifications are representative of those used in overbank and flood inundation areas on the Upper Mississippi and Missouri Rivers:

(1) Vertical Accuracy Requirement. 4-ft contour interval. DEM grid elevation accuracy: ± 1.33 ft. DTM hard spot elevation accuracy: ± 0.67 ft.

(2) Digital Elevation Model (DEM). 5 m post spacings in flood plain. Add "mass points" on levees ... i.e., "Digital Terrain Model (DTM). Cut in all breaklines manually.

d. Deliverables. The cross-sections are converted into the particular hydraulic model format --e.g., HEC-RAS. Usually the surveyor (or A-E firm) is responsible for delivering the cross-section data in a specified model format. Scopes of work will define specifications, lateral coverage, format requirements, and deliverables for items such as: Horizontal Datum -- NAD27 or NAD83; Coordinate grid system -- SPCS or UTM; Vertical Datum -- NGVD29, NAVD88, LWRP, IGLD; DEM & DTM breaklines/mass points; River, River Reach & River Station Identifiers; Cross-Section cut lines; Cross-Section surface line; X-Y coordinates of section end points; X-Y-Z coordinates for each point on section; Transformed coordinates to station-

elevation format; Main Channel Bank Station Points; Left and Right Overbank Lengths; Stream sections (Plan); Stream bank, levee, structure detail & breaklines; In-channel & overbank flow paths. Geometric cross-section data must be entered in hydraulic models in specific formats. These are fully described in operating manuals for these models—for example, the USACE HEC-RAS River Analysis System Hydraulic Reference Manual (Version 4.1 Jan 2010).

e. Survey methods. Hydraulic cross-sections are surveyed using similar equipment and methods as navigation project condition surveys. The main difference is that each cross-section is on a different alignment. The endpoints of each cross-section must be transferred from the map and input into the data acquisition guidance system—e.g., HYPACK. The endpoints coordinates can be digitized from the planning map or scaled by hand. The local SPCS (referenced to NAD83) should be used. The X-Y coordinate values of the cross-section endpoints can be directly input into line planning software, such as LINE EDITOR spreadsheet in HYPACK (Figure 9-13). A single, unique line is created for every cross-section, with no offsets. The line name should correspond to HEC naming convention. Once this spreadsheet is completed, it can be pulled into the survey guidance program to align individual stream sections.

(1) Small, shallow-draft vessels are used in order to obtain depths as close to the bank as possible. Leadline or sounding poles may be needed in shallow bank areas. Depths are logged using standard data acquisition software. A dense sounding density is not necessary for stream sections in that surface areas will be generalized (smoothed) in the hydraulic modeling programs due to data point per section limitations (e.g., 500 points). Thus, there is no point to obtain 20 depths/sec when only one depth per 100 ft may end up being used in the overall model.

(2) Cross-section horizontal positioning accuracy is not critical for hydraulic surveys. USCG DGPS Radiobeacon accuracy is more than adequate; in fact, autonomous GPS accuracy (10-20 m) might be adequate in many cases. Since USCG DGPS is available over much of CONUS, it is recommended for river engineering survey positioning. Code phase USCG DGPS may also be used for horizontal positioning of overbank surveys.

(3) Cross-section elevations are referenced to a consistent vertical datum, such as the legacy NGVD29 or replacement NAVD88. A dense network of benchmarks must be available along rivers or atop levees in order to set river staffs or gages to control hydrographic surveys. The required density of the vertical network will be a function of the river slope and the distance reliable interpretations can be made between gages. In general, the river surface elevation interpolation accuracy should be kept under ± 0.5 ft. Gages should be spaced at intervals to maintain this accuracy. Additional reference gages may be required if abrupt changes in slope occur in bends or around control structures. In general, depth accuracy requirements for hydraulic sections are not as critical as those for dredging and navigation surveys.

(4) Bank and short overbank sections may be run at the ends of lines if equipment and personnel are available. Normally, however, overbank sections are performed relative to baselines on the bank or using RTK or DGPS positioning techniques. Overbank cross-sections must connect with (and be aligned to) the hydrographic sections to ensure the full streambed is profiled.

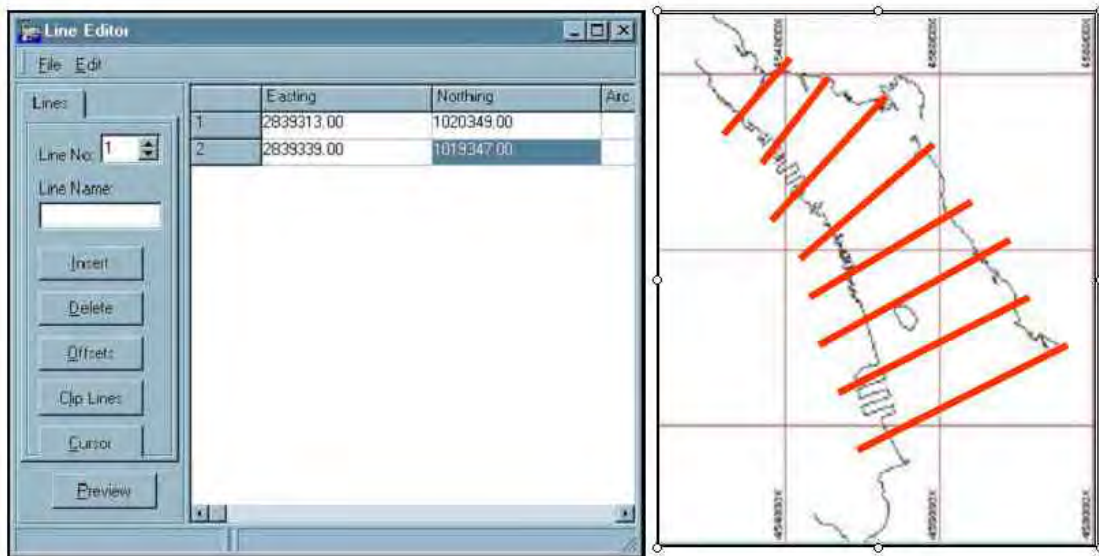

Figure 9-13. Setting up hydraulic stream sections using HYPACK Line Editor spreadsheet--a separate line is created for each cross-section.

9-11. Hydraulic Engineering Guidance on Cross-Section Locations. EM 1110-2-1416, River Hydraulics, contains detailed guidance for determining the location and spacing of stream cross-sections. Surveyors performing these studies should be aware of the hydraulic considerations that dictated the intended placement and alignment of stream sections. This is important in that field conditions may prevent sections being aligned as desired (due to vegetation, barge blockage, structure blockage, etc.). If new stream alignments or structures are discovered in the field, then additional cross-sections might be required. The field surveyor should make contact with the hydraulic engineer to determine alternate locations or need to include additional sections due to changed field conditions. Often, slight adjustments in section alignments can be made in the field without affecting the hydraulic model. Thus, knowledge of the engineering rationale for locating cross-sections is required by field surveyors in order to make reasonable adjustments or recommend modifications to the project engineer. The following guidelines on locating cross-sections for river hydraulic studies are summarized from EM 1110-2-1416.

- a. Cross-sections should be located at:
 - (1) All major breaks in bed profile.
 - (2) At minimum and maximum cross-sectional area.
 - (3) At points where roughness changes abruptly.
 - (4) Closer together in expanding reaches and in bends.

(5) Closer together in reaches where the conveyance changes greatly as a result of changes in width, depth, or roughness.

(6) Between cross sections that are radically different in shape, even if the two areas and conveyances are nearly the same.

(7) Closer together where the lateral distribution of conveyance changes radically with distance.

(8) Closer together in streams of very low gradient which are significantly nonuniform, because the computations are very sensitive to the effects of local disturbances and/or irregularities.

(9) At the head and tail of levees.

(10) At or near control sections, and at shorter intervals immediately upstream from a control (sub-critical flow).

(11) At tributaries that contribute significantly to the main stem flow. Cross sections should be located immediately upstream and downstream from the confluence on the main stream and immediately upstream on the tributary.

(12) At regular intervals along reaches of uniform cross section.

(13) Above, below, and within, bridges.

(14) Cross sections should be representative of the reaches adjacent to them, and located close enough together to ensure accurate computation of the energy losses. If the average conveyance between cross sections is used to estimate the average energy slope, then the variation of conveyance should be linear between any two adjacent cross sections.

(15) Cross sections should be located such that the energy gradient, water-surface slope, and bed slope are all as parallel to each other between cross sections as is pragmatic. If any channel feature causes one of these three profiles to curve, break, or not be parallel to the others, the reach should be further subdivided with more sections.

(16) On large rivers that have average slopes of 2 to 5 ft per mile or less, cross sections within fairly uniform reaches may be taken at intervals of a mile or more.

(17) More closely spaced cross sections are usually needed to define energy losses in urban areas, where steep slopes are encountered, and on small streams. On small streams with steep slopes, it is desirable to take cross sections at intervals of 1/4 mile or less.

(18) Recommended maximum reach lengths (distances between cross sections) are: (1) 1/2 mile for wide floodplains and slopes less than 2 ft per mile, (2) 1,800 ft for slopes less than 3 ft per mile, and (3) 1,200 ft for slopes greater than 3 ft per mile. In addition, no reach between cross sections should be longer than 75 - 100 times the mean depth for the largest discharge, or about twice the width of the reach. The fall of a reach should be equal to or greater than the larger of 0.5 ft or the velocity head, unless the bed slope is so flat that the above criterion holds. The reach length should be equal to, or less than, the downstream depth for the smallest discharge divided by the bed slope.

b. EM 1110-2-1416 also notes the following considerations that are applicable to field surveyors acquiring cross-sectional data.

(1) Cross-sections are run perpendicular to the direction of flow at intervals along the river. The "reach length" is the distance between cross-sections. Flow lines are used to determine the cross-section orientation. The hydraulic engineer will provide these orientations to the surveyor.

(2) The cross-section should be referenced to the stream thalweg and by river mile as measured along the thalweg. From this the reach lengths between sections is computed. Endpoints on the cross-section should be geographically coordinated using the local State Plane Coordinate System.

(3) End station elevations. The maximum elevation of each end of a cross section should be higher than the anticipated maximum water surface elevation.

(4) Local irregularities in bed surface. Local irregularities in the ground surface such as depressions or rises that are not typical of the reach should not be included in the cross-sectional data.

(5) Bent cross sections. A cross section should be laid out on a straight line if possible. However, a cross section should be bent if necessary to keep it perpendicular to the expected flow lines.

(6) Avoid intersection of cross sections. Cross sections must not cross each other. Care must be taken at river bends and tributary junctions to avoid overlap of sections.

(7) Inclusion of channel control structures. Channel control structures such as levees or wing dams should be shown on the cross section, and allowances in cross-sectional areas and wetted perimeters should be made for these structures.

9-12. Hydraulic Cross-Sections Adjacent to Bridges or Culverts. Cross-sections need to be densified near bridges and culverts in order to analyze the flow restrictions caused by these structures. Required sections are shown in Figure 9-14. The downstream section is located such that the flow is not affected by the structure--a distance of about four times the average length of

the side constriction caused by the structure abutments. Two cross-sections are run a few feet upstream and downstream of the structure. The upstream section is located slightly further away from the structure--prior to the flow constriction. The upstream section is typically located at a distance equal to the width of the bridge opening or the length of the abutment. Variations in this general scheme exist.

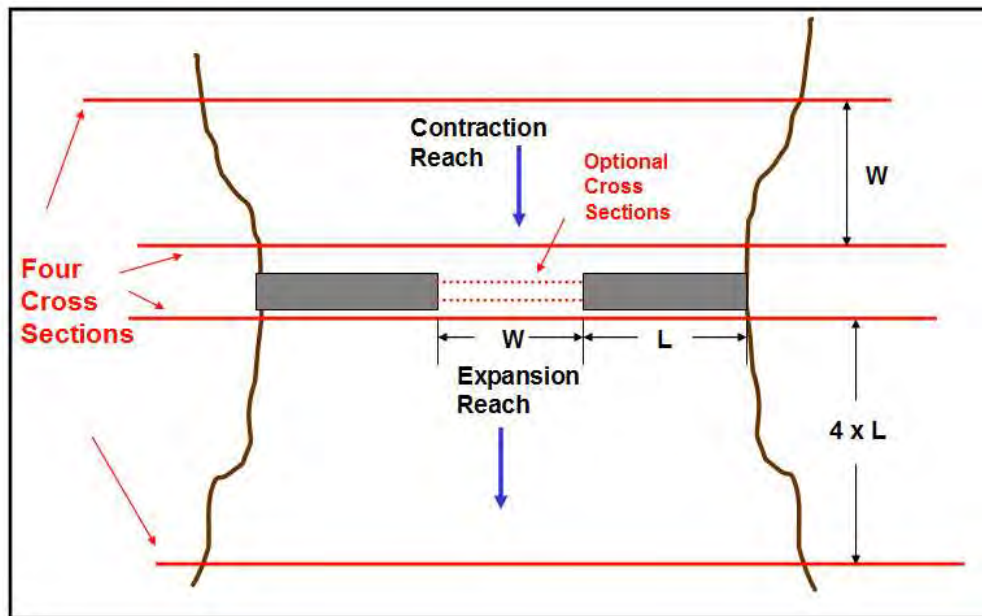

Figure 9-14. Cross-section locations at a bridge or culvert

Other bridge detail is also required, such as dimensions of the bridge deck, abutments, piers, etc. If this information is not available from as-built drawings of the structure, then they will have to be measured as part of the field survey.

a. Navigation locks and dams. Most of the inland navigation projects maintained by the Corps contain navigation locks and dams. The flood profile characteristic in the regulated pools between these structures requires hydraulic modeling. Survey cross-sections may need to be taken more frequently around locks and dams and within the pools due to sediment build up.

b. River control structures. Controls are natural or artificial structures that affect the upstream water surface profile. Control can be dams, rock outcrops, falls, or drop structures. Dikes (i.e., wing dams or jetties) or weirs also impact the flow of water in a channel, depending on the stage. Cross-sections need to be taken on and adjacent to such areas.

c. Levees. Levees prevent floodwaters from entering the floodplain. Levees constrict river flow, resulting in a higher water surface. When levees fail, the protected floodplain becomes available for storage; thus the need for detailed cross-sections over levees and well into the floodplain. Cross-sections are taken at the beginning and end of levees. Floodplain storage

can be computed from the DEM model or from cross-sections generated from the DEM surface. In addition, continuous top of levee profile elevations may be required. These can be accurately and efficiently obtained using topographic RTK survey methods. Levee cross-sections can also be run from the same RTK set up.

9-13. Required Accuracy of Hydraulic Cross-Section Data. The accuracy requirements for cross-sections on a river and floodplain are highly dependent on other factors that make up the overall hydraulic prediction model. Other factors, such as Manning's coefficient, have a far more significant impact on the accuracy of computed water surface profiles. In general, horizontal accuracy is not as critical for hydraulic studies as for other navigation surveys. Vertical accuracy is also not as critical, provided there are no systematic errors or blunders in the data. The Hydrologic Engineering Center (HEC) conducted a study of survey accuracy requirements relative to the resultant accuracy on a predicted water surface model--HEC RD 26, 1986. Following are conclusions derived from this 1986 study.

a. For areas with high Manning n-value reliability, the effect of cross-section elevation inaccuracy is insignificant on the computed water profile accuracy. For example, on a river slope of 1 ft/mile, cross-section elevation points accurate to ± 2.0 ft (1- σ standard deviation) will affect water surface profile accuracy by less than 0.1 ft. A ± 2.0 -ft elevation accuracy can be easily achieved by most conventional topographic and hydrographic surveying methods. A ± 2.0 ft (1- σ standard deviation) can also be obtained by manually digitizing the cross-section directly on a photogrammetric stereo model which has been designed to achieve an equivalent 10- to 12-foot contour interval standard--i.e., flown at an altitude that results in a negative scale of 1 inch = 3,333 to 4,000 ft.

b. For cross-sections developed by photogrammetric methods (i.e., an HEC cross-sectional DTM is directly developed by an operator on the stereo plotter), there is no significant impact on water surface profile accuracies between stereo models designed for 2-ft (± 0.3 ft 1- σ) and 5-ft (± 0.8 ft 1- σ) contour accuracies--the accuracy of the computed water surface profile is not significantly improved by using the presumed more accurate 2-ft contour standard. For areas with highly reliable n-values, there is no significant difference on the surface profile's accuracy between 2-ft and 10-ft (± 1.7 ft 1- σ) contour mapping accuracies.

c. Cross-section elevations digitized directly from photogrammetric stereo models are more accurate than cross-section elevations indirectly derived (e.g., scaled--manually or electronically) from topographic contour maps. Thus, cross-sections indirectly derived from an existing contour map, or from a digital terrain model (DTM)--which has been constructed using triangulated irregular networks based on a gridded digital elevation model (DEM) and auxiliary breaklines--will not be as accurate as cross-sections directly digitized on the stereo model. (The 1986 study did not assess the effect of DEM "post" spacing density on indirect elevation accuracy since these techniques were not commonly used at that time. In addition, the old manual process of generating cross-sections by scaling intersecting contours is more rarely used given elevations can be obtained directly from DEM/DTM/TIN models.)

- d. Mean water surface profile errors resulting from less reliable estimates of Manning's coefficient are several times those resulting from survey measurement errors alone.
- e. Error prediction equations (in the 1986 study) can be used to determine the mapping technique and accuracy needed to achieve a desired computed profile accuracy. Conversely, the error prediction equations can be solved for required digital elevation point accuracy given a specified mean water surface profile accuracy and other hydrologic factors.
- f. Assuming a mean water surface profile modeling accuracy requirement of between 0.2 ft and 0.5 ft, a reliably known n-value, and low gradient stream slope, the required digital elevation accuracy along a cross-section is needed to no better than ± 2.2 ft. This accuracy level can be easily achieved by conventional (terrestrial) topographic surveying methods and hydrographic surveying methods. It also could be obtained by digitizing cross-section elevation points from a photogrammetric stereo model designed to meet a 10-ft contour interval accuracy standard--a low accuracy product.
- g. If cross-section elevation points are indirectly derived from a newly mapped DTM (DEM) surface, then the point accuracy of the DEM grid (posts) must be better than that needed for directly digitized cross-section points. This increased accuracy will be a function of the "post" spacing (density) and local terrain gradient. Accuracy differences will not be significant in low gradient plains regardless of the post spacing density. Overall, directly observed cross-sections should be obtained in lieu of indirect methods.
- h. In low gradient flood plains, cross-sections may be derived using indirect DEM/DTM/TIN model methods. DEM post-spacing should be variable and a function of the (1) required point accuracy, and (2) average terrain gradient. For example, given ± 2 ft required cross-section point elevation accuracy and a 2% gradient, a 50-ft DEM post spacing would be recommended. Breaklines are added at critical points, e.g., tops/bases of levees, roads, etc., resulting in an "irregular network of mass points with breaklines."
- i. In high-gradient areas (e.g., levees, road/rail embankments, etc.), photogrammetric cross-sections should be directly digitized from the stereo model. DEM/DTM derived cross-sections would not be recommended due to the dense post spacing that would be required to achieve the equivalent accuracy.
- j. Digital elevation data from USGS quadrangle DEMs may be sufficiently accurate for cross-sectional data outside Federal levees--provided these maps are relatively current. Any additional mapping in these potential overbank areas could be performed to 10-ft contour interval standards.
- k. Levees, roadways, railroads, and other similar flood control embankments should be profiled to around ± 0.5 ft accuracy. It will often be more cost-effective to perform this profiling using aerial mapping techniques if concurrent mapping/cross-sections are being performed over the same area. On levees with excessive vegetation, ground-based topographic cross-sections will be needed to supplement the photogrammetric sections and/or profiles.

- l. Inundation mapping accuracy requirements are independent from water surface profile accuracy requirements. No photogrammetric mapping technique will cost-effectively measure ± 0.1 to ± 0.2 -ft first-floor elevation accuracy throughout the study region. RTK methods will not normally reach these accuracy levels either; thus, traditional differential leveling methods may be required.
- m. Inundation mapping accuracy requirements will depend on the flood plain gradient, land use, and control features (embankments, etc.).
- n. Unnecessary or unanalyzed topographic mapping accuracy specifications will significantly deplete existing mapping resources as mapping costs vary exponentially with the vertical accuracy requirement.
- o. A ± 2 -ft elevation data point standard deviation may now be easily achievable with airborne inertial-aided GPS control and LIDAR topographic mapping techniques-- i.e., minimal ground photo control points required.

SECTION II

Hydrographic Surveys of Reservoirs and other Impounded Areas

9-14. Reservoir Surveys. The Corps maintains some 704 dams, many of which have upstream reservoirs and downstream pools requiring periodic hydrographic surveys. The reservoirs above the 75 hydropower dams operated by the Corps must also be monitored for sediment build up. A typical hydropower reservoir project shown in Figure 9-15. Most of these reservoirs are primarily used for flood risk management (i.e., flood control) and water storage. Other secondary uses of these reservoirs include recreation and water supply. Reservoirs are impounded by either concrete or earth-fill dams. A variety of outlet works and spillways are used to regulate, control, or release outflows from the reservoirs. Loss of reservoir storage capacity due to sediment accumulation impacts hydroelectric power generation and flood control operation. Useful storage is the volume of water between the minimum pool (e.g., outlet invert elevation) and normal pool (e.g., spillway crest elevation) levels. Storage capacities are affected by sedimentation build up over time--typically below the minimum pool elevation. Reservoir sedimentation surveys are performed to monitor periodic build up of sediment in the reservoir, which allows computation of reductions in reservoir capacities. Other purposes may include base data for recreational navigation maps or charts in support of Natural Resources office activities--e.g., topographic/bathymetric maps depicting fishing or camping areas (Figure 9-16). Reference should be made to EM 1110-2-4000, Sedimentation Investigations for Rivers and Reservoirs, for planning, conducting, and modeling reservoir sedimentation investigations.

- a. Survey methodology. Reservoir sedimentation surveys require a combination of hydrographic and topographic methods. Hydrographic surveys are performed to determine the underwater topography. Topographic and photogrammetric methods are performed to map the

areas above the pool in which the hydrographic surveys were performed. The surveys are merged into a digital terrain database from which quantity take-offs are made for reservoir capacities. The recommended accuracies outlined in Table 9-1 will usually suffice for reservoir surveys. However, these standards are only applicable in depths less than 100 ft. IHO standards may be noted in deeper reservoirs—see Chapter 3 and Appendix E. Detailed surveys of the dam, intake structures, or spillways will usually require higher accuracy.



Figure 9-15. Reservoir behind Clarence Cannon Hydropower Dam and Mark Twain Lake, Missouri. (St. Louis District)

b. Survey boats. Hydrographic surveys are usually performed with small, trailerable boats, using automated hydrographic data collection systems. Many reservoirs have boat ramps for recreational purposes, so larger, trailerable boats can be easily launched. If there are no launching facilities, a small, carryable, 12-ft to 16-ft open skiff may have to be used--provided reservoir conditions are calm and protected. Jet ski and small inflatable boats have also been used to survey inaccessible reservoirs.

c. Horizontal positioning. The most efficient positioning method is code phase DGPS--using USCG radiobeacons or private provider networks. Alternately, total stations may be used for small reservoirs or impoundment basins; however, this may require locating or establishing additional horizontal control points around the basin, adding considerable time and cost to the final survey. Total station positioning may be needed near dams, power plants, or outlook structures if satellite signals are obscured or interfered with. Positional accuracy is not critical for reservoir sedimentation surveys--the accuracy levels recommended in Table 9-1 may be followed. Positioning procedures and calibration checks should conform to the guidance in this manual.

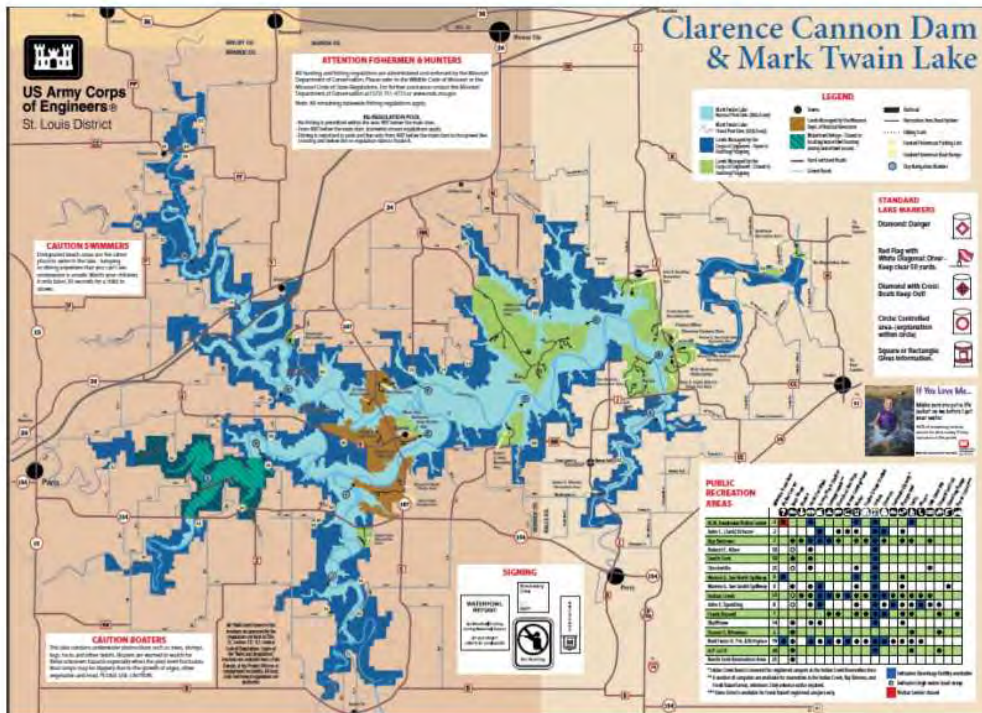

Figure 9-16. Recreational map of Mark Twain Lake, Hannibal, MO. Normal Pool (606.0 ft) and Flood Pool (638.0) contour limits are shown on this map. (St. Louis District)

d. Reference elevations. Depth measurement accuracy is critical in reservoir sedimentation surveys. Depths are measured relative to either NAVD88 or the legacy NGVD29 datum—see EM 1110-2-6056 for additional guidance. The master gage or staff elevation reference used for the project should be used as a reference—usually located near the outlet works or dam. The elevation of the gage/staff should be checked by connection to existing benchmarks. For long reservoirs, a slope gradient may exist; requiring additional gages be set in the upper reaches. Gages must be continuously monitored if there are short-term fluctuations in the pool; otherwise, twice-daily readings may be adequate. Bar checks are critical to ensure no systematic errors are present—especially on small boats. Sound velocity probes are needed to measure and correct for velocity changes in deeper reservoirs, i.e., at depths beyond the bar check reach and where changes in water temperature are most likely. Since most velocity probes are designed for 50- to 75-ft navigation projects, additional cable must be added to reach down to 200- to 300-ft depths.

e. Density of coverage. The topographic relief and size of the reservoir will dictate the coverage requirements. Single beam echo sounders are used; however, a multibeam system might be employed if full coverage detail is required for scour studies near the dam or outlet works. Single beam survey lines are typically run bank-to-bank perpendicular to the axis of the reservoir. Since the objective is to compute the volume of an irregularly shaped impoundment

basin, there is no rigid requirement for a specific cross-section alignment or spacing. Typically, lines are spaced between 200 and 400 ft, with a not-to-exceed spacing specified. If the topography in the reservoir is fairly uniform, then line spacing may be increased. Specifying too tight a line spacing on a large reservoir is uneconomical. The accuracy requirements of the reservoir capacity computation must be fully considered in selecting a line spacing. Since volumes are typically computed by contour intersect methods, the accuracy of the reservoir storage volume is a primary a function of the computed areas for each elevation stage. Thus, the derived digital terrain model (DTM) of the survey must have sufficient density to delineate accurate contours from which areas are computed.

(1) Since successive surveys are measuring storage trends, it is only necessary to obtain data at a density consistent with this requirement--e.g., 1% of capacity. Given a percent error in capacity (acre-ft), area (acres), and average depth at spillway elevation, the average accuracy of the 1-ft DTM contours (in \pm acres) can be computed. In general, a contour acreage accuracy of ± 1 acre is easily achievable if the survey density is adequate.

(2) Depth accuracy must be free of any systematic biases. A bias of say (+) 0.3 ft over a 1,000 acre reservoir (i.e., 300 acre-ft) would represent a significant error (3%) even if the storage is only 10,000 acre-ft. Thus, accurate gage readings, bar checks, and velocity calibrations are critical to preclude against systematic errors in reservoir surveys. Random errors in the depth measurements are not significant as long as there is no bias--e.g., a depth accuracy of +0.0 ft (bias) \pm 1.0 ft (random) is acceptable, whereas an accuracy of (-) 0.3 ft \pm 0.3 ft is not. Refer to Chapter 3 for further discussion on depth accuracy requirements.

f. Topographic mapping. In order to compute the full capacity rating for a reservoir, topography must be obtained up to the normal pool or spillway crest elevation; or higher, to a surcharge elevation that may be specified. Existing maps or pre-construction as-built drawings of the project may already be available for this data; otherwise, full topographic and/or photogrammetric mapping surveys of these areas will be required. Approximate computations may be made using USGS quad maps; however, their small-scale and poor vertical accuracy will often not provide adequate results.

g. Area and storage volume capacity computations. A variety of automated techniques are used to compute the storage area-capacities. The combined hydrographic and topographic survey data are used to generate a complete TIN surface model of the entire basin, or perhaps bordered portions of a basin. This TIN model can be derived from all data sources: single beam, multibeam, aerial mapping, LIDAR mapping, USGS quads, etc. From this TIN model, level surface increments (normally 1-ft contours) are generated and the area (in sq-ft or acres) for each contour section computed. The storage volume (typically in acre-ft) for each contour segment can be computed by projecting this area over the selected contour interval. The areas and accumulated storage volumes are tabulated and plotted on a standard area-capacity curve format. Reservoir storage capacity relative to the watershed area runoff may also be computed and tabulated in acre-ft per inch of runoff.

topographic survey is taken as a baseline and successive hydrographic surveys performed over the years are compared with the base survey. The HYPACK "TIN to TIN Difference" software

Test File	: d:\demofiles\areacapacity\cochiti_dtm.sd	
Horizontal Coordinate System	: FP_NAD27_New_Mexico_Central	
Start above bottom	: 0.00	
Measurement delta	: 1.00	
Elevation	Area (Acres)	Volume (Acre Ft.)
5241.89	0.00	-0.00
5242.89	0.20	0.09
5243.89	0.33	0.35
5244.89	0.56	0.78
5245.89	1.06	1.58
5246.89	1.39	2.82
5247.89	1.88	4.42
5248.89	2.46	6.60

Figure 9-18. Portion of Area-Capacity table for Cochiti Reservoir. Dam crest is at 5,482 ft; thus, only the lowermost pool elevation capacities are shown here.

module may be used to identify and quantify material gains and losses between two different reservoir surveys. A color-coded model of gained and lost material is generated as shown in Figure 9-19. Volumes between the two TIN surfaces are calculated at nodes on a gridded dataset. The TIN models can optionally be "bordered" to isolate a particular section of interest.

i. Cochiti Reservoir sedimentation assessment. Figure 9-20 illustrates the use of DTM models in evaluating sediment changes in a reservoir. DTM terrain models were developed from a 1963/1972 Pre-Dam Terrain Model (Base Survey) and a 1999/2004/2005 Post-Dam Terrain Model (Epoch 1 Survey). Surface comparisons were made (Epoch 1 minus Base) to assess sedimentation transport characteristics, calculate available storage for dam control operations, evaluate sediment sampling sites for use in transport modeling, and evaluate impoundment impacts to cultural sites. The cross-section profile in the figure shows sediment erosion and build-up between the Base and Epoch 1 surveys, ranging from (-) 5-ft to + 15-ft changes across this section. In the upper reaches of the reservoir, accretions upwards of 70 ft were measured.

j. Application reservoir survey project. See Appendix L (Almond Lake Reservoir Survey and Area Capacity Curves--Baltimore District) for a survey report describing field to final product compilation.

9-15. Surveys of Howard Hanson Dam (Seattle District). Appendix O attached to this manual contains a survey report describing a multi-sensor survey of a large earth and rockfill dam in Seattle District. This effort involved precision upland control and terrestrial laser scanning survey, in conjunction with a multibeam bathymetric survey conducted on Howard A. Hanson Dam and Reservoir near Enumclaw, Washington in December 2009. The survey was conducted by David Evans and Associates for the Seattle District. A variety of survey sensors and software

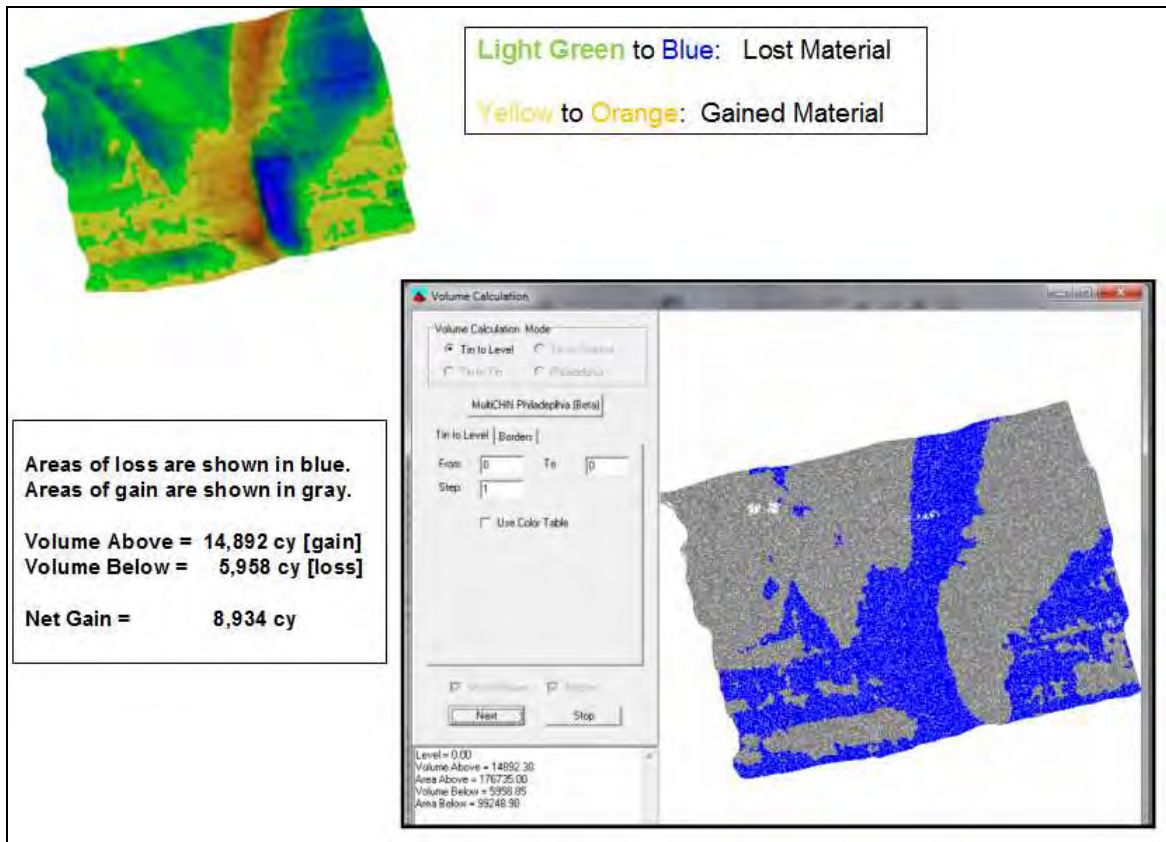

Figure 9-19. Accretion and erosion areas in a reservoir from TIN models comparing two hydrographic surveys. Net gain or loss of material is calculated over the defined project. (HYPACK "TIN to TIN" Volumes)

was utilized to map the dam site. These included terrestrial laser scanning, marine based laser scanning, multibeam swath bathymetry, RTK, conventional total station equipment, cyclone XYZ point cloud editing, CARIS hydrographic processing, and CARIS gridding and difference calculations.

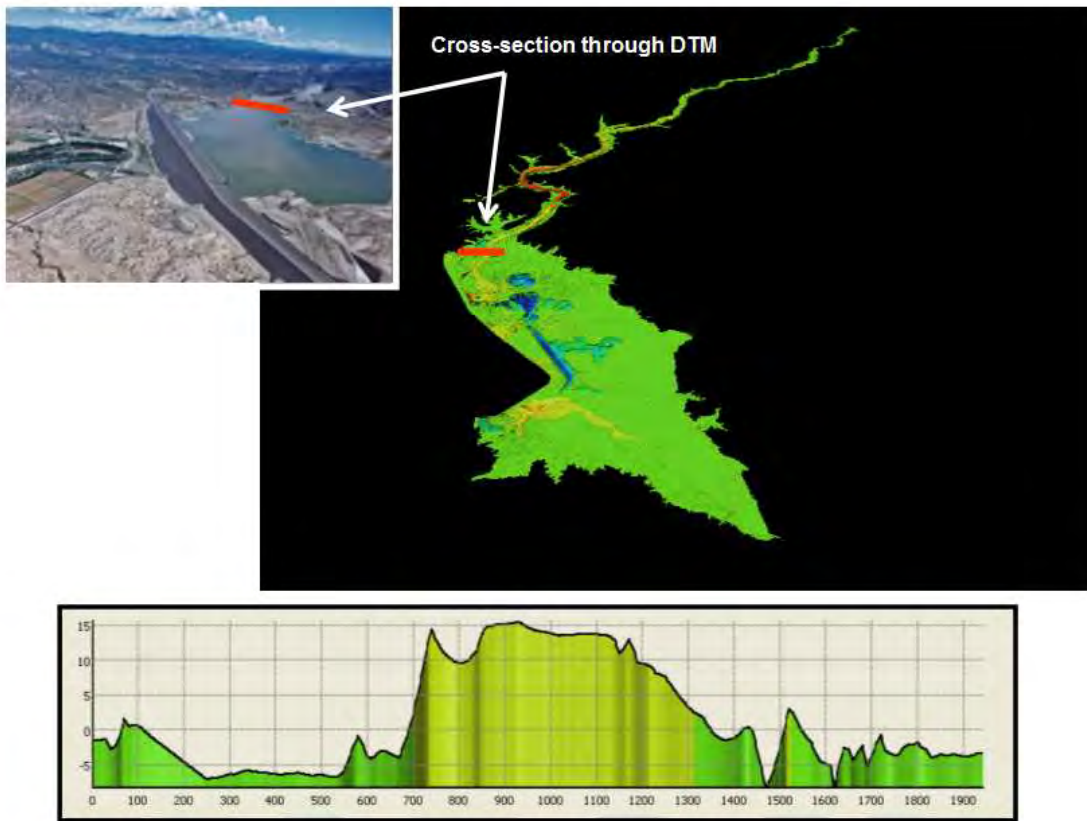

Figure 9-20. Upper portion of figure is a DTM model of the elevation differences between the Base Survey and the Epoch 1 Survey. The lower portion shows a cross-section profile at the approximate location indicated. (Cochiti Reservoir, Albuquerque District.)

SECTION III

Summary of Recommended Elevation Accuracy and Performance Standards for Inland Surveys

Table 9-1. Summary of Recommended Elevation Accuracies for Inland Surveys.

<u>Project</u>	<u>Repeatability</u>	<u>95% RMS Accuracy</u>
Inland Navigation Surveys		
Controlled Pools	0.3 ft	±0.5 ft
Free flowing rivers (non-RTK)	0.5 ft	±0.8 ft to > ±1 ft

EM 1110-2-1003
30 Nov 13

Lock and Dam Surveys	0.2 ft	±0.2 ft
Revetment and River Stabilization Structure Surveys	0.2 ft	±0.2 ft to ±0.5 ft
H&H Surveys		
Hydrography	n/a	±1.0 ft
Topography (DEM)	n/a	±1.33 ft (4-ft contour)
Breaklines	n/a	±0.5 ft
Reservoir Surveys		
Hydrography	0.3 ft	±0.8 ft
Topography	n/a	±1.33 ft (4-ft contour)
Dam embankment	0.1 ft	±0.2 ft

NOTE: These are recommended standards based on typical USACE project conditions and current survey instrumentation. They are based on the experience and recommendations from USACE personnel who developed and reviewed this manual. Each inland civil works project will have unique requirements that may require different standards. Refer also to discussions in Chapter 3.

Table 9-2. Recommended QC and QA Procedural Standards for Inland Surveys.

Procedure	Recommended Application
Bar Check Calibration	Perform periodically, or at minimum, quarterly. Frequency of bar checks can be reduced if average velocity repeatedly correlates with velocity cast data. Perform at beginning of critical site or structure investigation project.

Velocity Cast Calibration	Perform, at minimum, twice daily. More often in highly variable waters.
Squat/Settlement Calibration	Perform annually over different vessel speeds and loading conditions.
Latency Calibration (Single beam)	Perform periodically to obtain average correction over time. Perform at beginning of any critical structure survey.
Patch Test (Multibeam)	Perform periodically (at minimum semi-annually) to obtain average roll, pitch, yaw, and latency corrections over time.
Motion Compensation (Heave, Pitch, Roll, Yaw)	Required for multibeam surveys. Apply on single beam surveys if sea conditions warrant correction.
Inertial-aided RTK/PPK	Recommended in obstructed areas (bridges, dams, etc). Optional: Total Station control.
Position Calibration (Horizontal)	Perform at beginning of new project at PPCP or periodically check RTN/RTK v code DGPS.
Stage/Pool Calibration	Twice daily at reference gage. On free-flowing rivers minimize uncertain gage extrapolations or interpolations with RTK elevation transfer.
Vertical Check (RTK)	Perform twice daily at project reference gage.
Vertical Datum Verification	Refer to EM 1110-2-6056 for periodic requirements to ensure river, pool, and reservoir datums are consistent with NOAA reference datums.
Survey Coverage (Density)	Cross section spacing as required in project scope. 100% or 200+% coverage recommended on critical underwater structure surveys.
Quality Assurance Performance Tests	Perform periodically against other vessels at constant test site or in lock chamber if available. Perform internal repeatability check daily on critical structure surveys.

EM 1110-2-1003
30 Nov 13

THIS PAGE INTENTIONALLY LEFT BLANK

CHAPTER 10

Construction Dredging Measurement, Payment, and Clearance Surveys

10-1. General Scope. This chapter provides an overview on hydrographic surveys performed in support of the USACE dredging program. Dredging support surveys, channel templates, project clearance assessment, and payment quantity computation methods are covered. This chapter primarily focuses on in-place measurement and payment surveys in coastal navigation projects, as distinguished from dredging projects where payment is based on daily rental rates. It also provides general background information on dredging contract clauses that deal with measurement and payment surveys. The Civil Works Cost Engineering Mandatory Center of Expertise at the Walla Walla District can provide more comprehensive information on dredging estimates with several online tools .

a. "Best Practices." The guidance presented in this chapter is compiled from best hydrographic survey practices recommended and utilized by various USACE districts with extensive dredging programs. It may not be applicable to all dredging projects that may have unique environmental conditions or survey assessment requirements. Thus, all recommended "standards," QC calibrations, QA performance testing, bin sizes, etc. in this chapter shall be considered as general guidance only; they are not absolute or mandatory requirements.

b. Survey methods. Survey procedures, including quality control calibrations and quality assurance performance testing, are covered in Chapter 4 (Single beam), Chapter 5 (Multi-transducer), and Chapter 6 (Multibeam).

c. Survey accuracy standards. Recommended accuracy standards for dredging surveys are covered in Chapter 3. As detailed in Chapter 3, these generic "standards" may not be applicable to all dredging projects.

d. For detailed guidance on USACE dredging policies and practices, refer to the appropriate regulations and supplemental guidance manuals applicable to dredging--e.g., ER 1130-2-520, Navigation and Dredging Operations and Maintenance Policies. Hydrographic survey data is also used to provide input for applicable topographic parameters (e.g., average bank height) in the USACE Cost Engineering Dredge Estimating Program (CEDEP) for Pipeline Dredges.

10-2. Background. The USACE performs hundreds of surveys annually that are used to monitor dredging in over 12,000 miles of navigable inland and intracoastal waterways, and some 926 authorized coastal and Great Lakes deep- and shallow-draft harbors. During Fiscal Year 2009, the USACE dredged 263 million cubic yards of material. Approximately 82% of this work was done by contract dredging, involving over 183 contracts. The USACE-owned dredge fleet performed the remainder of the work. Hydrographic surveys are conducted in support of these

dredging operations--both for USACE-owned dredging plant and private contracted dredging operations.

a. Dredging measurement and payment surveys for contracted construction are usually performed by USACE survey crews; however, they may be conducted by independent Architect-Engineer (A-E) survey firms or the dredging contractor's survey crews. Most dredging contractors generally maintain an independent survey capability to monitor dredge performance and progress, and often as a quality check on USACE measurement and payment surveys.

b. Dredging support surveys typically require high degrees of accuracy since they are used to estimate annual dredging budget and quantity requirements, determine dredging contractor payment, and to certify final acceptance and clearance of a project to its authorized or constructed navigation depth. In many instances, the adequacy and accuracy of these hydrographic surveys are reviewed and challenged by contractors, with resultant disputes involving: the amount of material removed for payment; unexcavated shoal material remaining above the required dredging grade; or the adequacy of acoustic and density measurements of unconsolidated materials in the channel bottom. In order to minimize these disputes and construction contract claims, the quality control procedures and performance testing guidance covered in previous chapters of this manual should be rigorously followed. All dredging surveys thus require the utmost in accuracy, quality control, and timeliness, as explained below.

10-3. Types of Dredging Support Surveys. The following paragraphs describe some of the surveys used to monitor dredging operations in river and harbor navigation projects.

a. Dredging Plans and Specifications (P&S) surveys. Surveys and investigative studies performed to gather terrain, bathymetric, geophysical data, and related site plan information in advance of a design effort are referred to as "P&S" surveys, or often "bid surveys." These P&S surveys will be used to produce a set of engineering plans and specifications (and related cost estimates) for construction or dredging. P&S hydrographic surveys are required on river and harbor dredging construction and also for many other forms of marine construction in which detailed site plans are essential to the bid documents. This includes construction of offshore structures (jetties, groins, etc.), disposal areas, control structures (locks, dams, spillways, dikes, control structures, reservoirs, etc.), and beach/bank erosion protection. P&S surveys should be conducted as close to the solicitation advertisement date as possible--typically within 120 days or less, depending on estimated shoaling rates.

b. Project Condition Surveys. Hydrographic surveys of USACE deep-draft navigation projects are typically performed on at least an annual basis. These Project Condition Surveys are used to assess needs for maintenance dredging, and are often used as the basis for the estimated quantities in dredging contract documents from which bids are made. In effect, they often become P&S surveys.

c. Pre-dredge surveys. Once a dredging contract is awarded and dredging plant and equipment are on site, pre-dredge surveys are performed by the government over the contract

area as close to the start of dredging as possible--generally within 14 days prior to commencement of work in a defined reach (i.e., Acceptance Section) to be dredged. These Pre-Dredge surveys are often referred to as "Before-Dredging" surveys, or "BDs." Plots of Pre-Dredge surveys and related quantities requiring excavation are usually required within two (2) days of completion of the surveys. The quantities from the Pre-Dredge surveys are compared with the quantities that were estimated in the contract solicitation documents--i.e., the Plans & Specifications surveys. Construction contracts typically contain a "Variation in Estimated Quantities" (VEQ) clause that is invoked when significant disparities between these surveys occurs. This clause provides for a modification of the unit price originally bid due to a significant change (usually $\pm 15\%$) between the estimated and actual quantities. Thus, both the contract P&S (Bid) survey and the Pre Dredge survey must be timely and accurate, especially in areas subject to rapid shoaling.

d. Progress payment surveys. Progress payment surveys are performed during the course of a dredging project for the purpose of estimating interim payments (normally monthly). These surveys are usually performed by the construction contractor and may be compiled from his daily surveys monitoring dredging progress.

e. After dredge, final clearance, and acceptance surveys. After-Dredging (AD) surveys are performed by the government as soon as possible after dredging in a reach or acceptance section is completed -- generally within five (5) days or less. Final survey plots and quantity computations are typically required within two (2) days of the survey in order to release the dredge to other work. Normally the After-Dredging survey suffices for assessing contract performance, and the project, or an individual acceptance section therein, is contractually "accepted" based on this survey.

(1) In many cases, the After Dredge survey reveals not all material has been removed and subsequent dredging, along with re-surveys, must be performed before final clearance/acceptance is verified. Often, repeated full-coverage channel sweep surveys must be performed to locate and remove material or man-made objects above grade. Channel sweep surveys may be made with multi-transducer boom sweeps, multibeam (swath) transducers, or bar-sweeps (sweep rafts).

(2) Typically, contract disputes over remaining material above the required depth involve the positional and depth measurement accuracy capabilities of the survey. These disputes often involve shoal material or objects that may be within the achievable tolerances of acoustic sounding equipment. Other issues may involve remaining shoal material 5 to 10 ft inside the channel toes--also near the tolerances of some survey positioning systems. In many cases, repeated surveys of these shoal areas yield different results, or may not agree with those performed by the dredging contractor's survey crew.

f. Offshore disposal or borrow area surveys. Disposal sites may be periodically surveyed to monitor misplaced material, minimum clearances, or required capping elevations. These surveys are performed by either single beam or multibeam systems. Quantity estimates of material placed are usually only rough estimates, particularly in deep sites (> 100 ft) where material may have been dispersed outside the area. Offshore borrow areas are surveyed on beach renourishment

EM 1110-2-1003

30 Nov 13

projects during the preparation of plans and specifications, and subsequently during construction to monitor area and grade restrictions.

g. As-Built drawings. The various after dredge and clearance surveys are combined to form the as-built survey drawing for the completed project, which is furnished to local sponsors and navigation interests.

h. Contractor access to government records. In accordance with USACE practice, dredge contractors are provided full and open access to all survey data obtained and processed by the USACE, for all surveys listed above. In addition, dredge contractor representatives are normally on board the survey vessel to observe any survey performed for payment or acceptance.

10-4. Dredge Contracting and Production Measurement Methods. There are two general methods for contracting dredging work: (1) Unit Price contracts, and (2) Firm Fixed Price (FFP) contracts. Unit price contracts are preferred by the USACE and are far more predominant than fixed price contracts. A short description of these contracts follows since hydrographic survey support and accuracy requirements will vary somewhat with the type of contract payment method.

a. Unit price--in-place volume measure. A majority of coastal dredging contracts in the USACE are awarded with payment based on in-place volume measure. These contracts determine payment based on the amount of material removed from a navigation channel (or placed, as in beach renourishment projects). This measurement is performed by comparing before and after dredging hydrographic surveys, and deducting any material that has been unexcavated; or over-excavated as indicated by the overdredged "non-pay" area in Figure 10-1. Payment is made based on the unit price bid by the contractor--typically per cubic yard (cy) or cubic meter. Use of in-place volume measurement requires that the USACE has the capability to "perform payment surveys in a timely and accurate manner" and can "assure that the surveys specified in the contract are sufficient to verify that the contract requirements are met." For beach renourishment projects, payment is based on before and after beach fill profiles, not from quantity excavated at the borrow area

b. Unit price--time measure. This type of dredging contract is used when the quantities of material cannot be accurately estimated by in-place volume survey methods, such as in active or erratic shoaling areas on river navigation projects, where rapidly fluctuating river stages exist, or where "accurate and timely surveys are difficult to accomplish" (ER 1130-2-520.) Dredging plant and equipment is leased at an hourly or daily rate bid by the contractor. On these types of

contracts, hydrographic survey accuracy requirements are not as demanding as in-place payment methods--usually due to high shoaling and material transport rates encountered. However, survey support is required to monitor channel dimensions and overall contract compliance. These rental contracts are most common on the inland navigation system, especially in the high shoaling areas of the Lower Mississippi River.

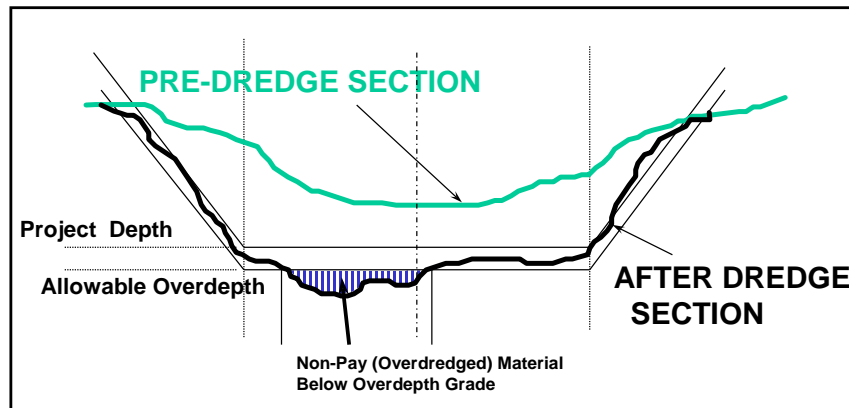

Figure 10-1. Typical Pre/Post Dredge Section. Payment limits and restrictions vary Corps-wide (e.g., Contour and Non-Contour Dredging methods--see paragraph 10-20).

c. Unit price--area measure. Area measure contracts are used in channels where depths of cut are relatively small and constant, and the area of dredge cut is the determining price factor, not depth of the "face" cut. The bid unit area (in square yards) is a channel section between fixed stations--thus the term "Station Dredging" for this method (see Figure 10-2.) Final hydrographic surveys are performed to ensure clearance to grade and acceptance of work--quantities may be computed; however, payment is made for the fixed section of work completed and accepted. These contracts are typically used in smaller navigation canals.

d. Unit price--scow or bin measure. Payment based on scow or bin measure, and/or related production/density flow meters, requires final after-dredging hydrographic surveys to certify clearance and contract acceptance. In addition, hydrographic surveys are needed to determine the amount of any excess dredging, for a payment reduction. Surveys may also be required to verify placement of stone or other material on shoreline protection projects, such as breakwaters or jetties.

e. Firm Fixed price--lump sum contracts. This method is used on projects where the rate of shoaling is small or predictable over the length of the contract. In this method, the dredge contractor bids a lump sum price for the job based on the contract plan and specification surveys. No pre-dredge survey need be performed; however, after-dredge clearance and acceptance

surveys are required to ensure the contractor has removed all material from the required prism. Dredging lump sum contracts are relatively rare.

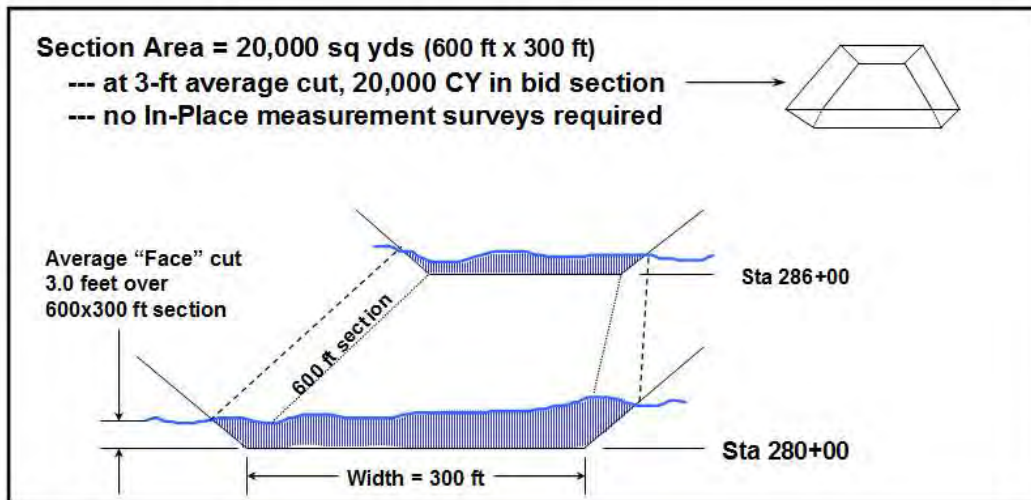

Figure 10-2. Station Dredging.

10-5. Definitions of Dredging Grades. Hydrographic surveys supporting dredging operations, and related dredge volume and payment computations, are performed with respect to a variety of payment prisms. Survey data must be collected at sufficient accuracy, coverage, and density so it can be evaluated relative to these prisms. Failure to collect survey data with sufficient coverage makes accurate pay quantity computation difficult, and can result in payment disputes. The following terms, excerpted in part from ERDC Technical Note EEDP-04-37 2007 (see Appendix A), are used to define the various payment reference surfaces found on navigation projects.

a. Authorized project dimensions. A channel's "required depth" or "project depth" and width are specified in the Congressional authorizing legislation for each project. This legislation may also detail the dimensions of channel entrances, bends (wideners), sidings, anchorages, and turning basins. The required project depth (authorized project depth) is based on the draft of the loaded "design vessel" plus, squat, sinkage in fresh water, effect of wind and wave action, under-keel safety and efficiency clearance, etc.--see ER 1110-2-1404, Hydraulic Design of Deep-Draft Navigation Projects. Project width of a channel is a function of traffic, winds, currents, curvature, vessel maneuverability, bank conditions, etc. (see Figure 10-3). In some instances, over-width dredging may be performed for advance maintenance purposes (EM 1110-2-1202, Environmental Engineering for Deep-Draft Navigation Projects).

b. Required Project Grade. This is the depth specified by the USACE for each dredging contract. Often it is the federally authorized depth, but in some cases can be less or more (for example, when advance maintenance has been authorized).

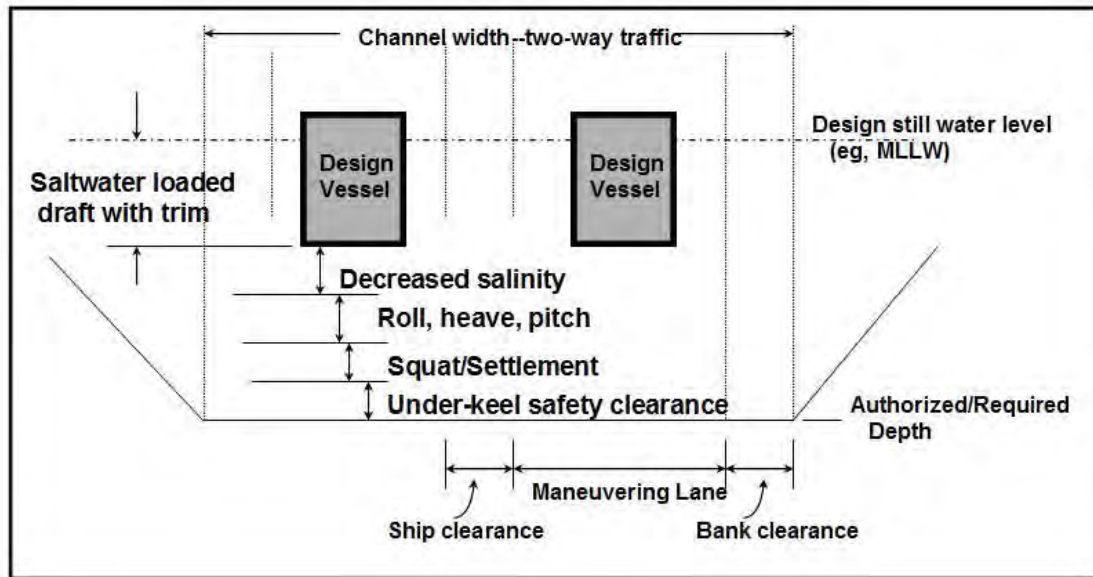

Figure 10-3. Typical Deep-Draft Navigation Channel Dimension and Clearance Parameters. (EM 1110-2-1613, Hydraulic Design of Deep-Draft Navigation Projects)

c. **Paid Allowable Overdepth.** Paid allowable overdepth dredging (depth and/or width) is a construction method for dredging that occurs outside the required authorized dimensions and advance maintenance (as applicable) prism to compensate for physical conditions and inaccuracies in the dredging process and allow for efficient dredging practices. The term “allowable” must be understood in the contracting context of what dredging quantities are eligible for payment, rather than in the regulatory context of what dredging quantities are reflected in environmental compliance documents and permits. Environmental documentation must reflect the total quantities likely to be dredged, including authorized dimensions, advance maintenance, allowable overdepth, and non-pay dredging. The paid allowable overdepth should reflect a process that seeks to balance consideration of cost, minimizing environmental impact and dredging capability considering physical conditions, equipment, and material to be excavated. ER 1130-2-520 provides that District Commanders may authorize dredging of a maximum of two feet of allowable overdepth in coastal regions and in inland navigation channels. Paid allowable overdepth in excess of those allowances or the use of zero paid allowable overdepth requires the prior approval of the MSC Commander. The USACE recognizes that there may be circumstances where there is a need for increased excavation accuracy in the dredging process, for example in environmental dredging of contaminated material, which dictate trading potential increased costs for a reduction in paid allowable overdepth, i.e., reducing the quantity of material required for special handling/placement or treatment.

30 Nov 13

d. **Advance Maintenance.** Advance maintenance is dredging to a specified depth and/or width beyond the authorized channel dimensions in critical and fast shoaling areas to avoid frequent re-dredging and ensure the reliability and least overall cost of operating and maintaining the project authorized dimensions. For maintenance dredging of existing projects, Major Subordinate Commands (MSCs) (Division Commanders) are authorized to approve advance maintenance based on written justification. For new navigation projects, advance maintenance is approved as part of the feasibility report review and approval process based on justification provided in the feasibility report.

e. **Non-pay Dredging.** Non-pay dredging, also known as "non-pay yardage," is dredging outside the paid allowable overdepth (or outside contour or non-contour dredging boundaries) that may and does occur due to such factors as unanticipated variation in substrate, incidental removal of submerged obstructions, or wind or wave conditions that reduce the operators' ability to control the excavation head. In environmental documentation, non-pay dredging is normally recognized as a contingency allowance on dredging quantities, and may and does occur in varying magnitude and locations during construction and maintenance of a project.

f. **Characterization Depth.** Regulatory compliance necessitates that material to be dredged be characterized and evaluated with regard to its suitability for the proposed placement of the material. Characterization and evaluation of dredged material must consider the entire dredging prism, including paid allowable overdepth and non-pay dredging.

g. **Channel side slopes and box cut allowances.** Side slope grades are designed based on the geophysical properties of the material on the channel banks. Side slope grades typically vary between from 1 H on 1 V (45 deg) up to 5 H on 1 V (11 deg). Advance maintenance and overdepth payment prisms are extended up the side slopes parallel to the authorized project depth prism, and payment may be allowed for material removed within these sections. In some instances, allowance may be made for material excavated below the payment prism based on the potential for undisturbed material to slough downward to the channel toe. This is commonly referred to as a "box cut allowance."

10-6. Factors Impacting Survey Coverage and Accuracy Requirements. This paragraph outlines some of the factors that will determine the requirements for a particular hydrographic survey supporting a dredging operation.

a. **Type of excavated material.** The type of excavated material (including its disposal) will impact required survey procedures. Areas with hard material, such as rock, may require blasting which could result in numerous rock fragments remaining above project grade by small amounts (e.g., 0.1 ft to 0.5 ft). Accurate acoustic or mechanical sweep surveys will be performed to locate these fragments and excavate or drag them clear. Maintenance dredging of soft material allows for less stringent survey methods.

b. **Unit price.** The bid unit price may impact accuracy requirements in a number of ways. High unit price material may often cause higher scrutiny of payment surveys and/or volume

computations. The unit price will also determine whether it is cost-effective for the contractor to dredge close to the required depth or to dredge significant amounts of overdepth material. When economics dictate that overdepth dredging is not economical, dredging close to the required depth can result in many remaining areas left above grade, and resultant clearance disputes.

c. Dredge equipment. The type of bottom material and resultant dredging equipment used may impact the accuracy requirements for a hydrographic survey. In the USACE, removal of loose, softer materials is normally accomplished by suction dredging (dustpan dredges, hopper dredges, hydraulic pipeline suction dredges, or sidecasters). Since these types of dredging operations are not as precisely controlled (in depth and location), survey accuracy and density of coverage may be reduced. For removal of hard, compacted material (e.g., rock), mechanical dredging is performed, using clamshell, dipper, or ladder dredges. This is typical of new work. A cutterhead dredge (combined suction and mechanical) is employed for either soft or hard material. Survey accuracy requirements are generally higher for mechanical or cutterhead dredge equipment since these operations can more precisely control the location and depth of cut. See also EM 1110-2-5025, Dredging and Dredged Material Disposal.

d. Unconsolidated sediments. One of the most difficult issues in evaluating hydrographic survey data occurs when low-density suspended sediments obscure the echo sounding return. This phenomena, commonly know as fluff or fluid mud, occurs in the natural low-flow environments, and may also occur during dredging operations due to the agitation of the bottom material. It is most pronounced in southeastern CONUS navigation projects. Multiple layers of fluff can occur, with these layers ranging from 1 to 15 ft above the bottom. Assessment of dredging progress, clearance above required depth, and the equitable payment grade can be extremely difficult--even when dual frequency sounders are used, or when correlation is made with non-acoustic devices (lead lines, sounding poles, density probes, etc.). As a result, contract payment techniques based on in-place volume measure can often be difficult and may require negotiated settlement. In some instances, after dredge surveys have shown more material in a channel than before dredging surveys. Certification of the clear navigable depth may also be tenuous where the firm channel bottom cannot be clearly determined. Procedures for performing and evaluating surveys in unconsolidated sediments are described in Appendix P attached to this manual.

10-7. Measurement, Payment, and Acceptance Survey Contract Specifications. The following excerpts are taken from clauses contained in most dredging contracts involving payment based on hydrographic surveys. These contract requirements have significance to the survey measurement process, both procedurally and technically, and the interpretation of the adequacy of USACE survey data. Although the government, as the contracting agent, developed these clauses to protect the government's interests, they also provide mechanisms for the contractor to challenge the government's interpretations and assessments, and obtain relief if necessary.

Contract clauses are continually changing; therefore, the abbreviated excerpts below may not be current. The currently approved contract clause should be obtained from the applicable procurement regulations.

30 Nov 13

(1) "Surveys for Acceptance: ... the [P&S hydrographic survey] drawings are believed to accurately represent conditions existing at the time indicated but the depth shown thereon will be updated as required by [Pre Dredge] soundings taken prior to commencement of dredging. [Final survey] determination of quantities removed to be paid for in the areas specified, after having once been made, will not be reopened, except on evidence of collusion, fraud, or obvious error ... The time for redredging to remove shoals and for [second] [third] and subsequent [hydrographic] surveys shall be the responsibility of the contractor."

(2) "... Final Examination and Acceptance: As soon as practicable after completion of the entire work or any section thereof ... such work will be thoroughly examined at the cost and expense of the Government by sounding or sweeping, or both, as determined by the Contracting Officer. Should any shoals, lumps, or other lack of contract depth be disclosed by this examination, the Contractor will be required to remove same by dragging the bottom or by dredging at the contract rate for dredging, but if the bottom is soft and the shoal areas are small and form no material obstruction to navigation, the removal of such shoal may be waived by the discretion of the Contracting Officer. The Contractor will be notified when soundings and/or sweepings are to be made, and will be permitted to accompany the survey party. When the area is found to be in a satisfactory condition, it will be accepted finally. Should more than two sounding or sweeping operations by the Government over an area be necessary by reason of work for removal of shoals disclosed by a prior sounding or sweeping, the cost of such third and any subsequent sounding or sweeping operations will be charged against the Contractor. The rate for each day in which the Government [survey] plant is engaged in such sounding or sweeping operations and/or is en route to or from the site, or is held, for the Contractor's convenience at or near the site for these operations, shall be [\$_____]*, except on Saturday, Sunday and holidays when the rate shall be [\$_____]."

(3) "... Inspection of Construction: ... the Government shall accept, as promptly as practicable after completion and inspection, all work required by the contract ... Acceptance shall be final and conclusive except for latent defects, fraud, gross mistakes amounting to fraud, or the Government's rights under warranty or guarantee ..."

a. Survey errors. The above contract acceptance clauses typically provide for a contractor to challenge the accuracy of any payment survey based on an "obvious error" in that survey. "Obvious error" provides extremely wide latitude for alleged survey deficiencies in that no specific magnitude of the error is defined. However, by implication, any allegations of "obvious error" must relate to recognized survey practices--i.e., conformance or non-conformance with the

"best practices" and other criteria in this engineer manual and references therein. Government-performed surveys, and assessments or evaluations thereof, must always be "above board" and performed in a manner that both represents the government's interests and is equitable to the contractor for the actual work performed under the contract.

b. Remaining shoals. The above excerpt from a typical acceptance clause provides latitude to the government in assessing the significance of remaining shoals. This assessment will evaluate

the magnitude of the shoal relative to the achievable survey tolerances, achievable dredging tolerances, and/or navigation impacts. Obviously, the positional and depth measurement accuracy tolerances of a survey must be thoroughly considered before a contractor is directed to undertake additional work at his time and expense. The Contracting Officer has authority to unilaterally direct a contractor to continue dredging any disputed shoal material under the "Disputes" clause.

c. The above part of the "Final Examination and Acceptance" clause requires the USACE to perform final (After-Dredging) acceptance surveys as expeditiously as practicable, and to release the contractor's dredge from the work. This clause also is applicable in cases where fraudulent work may have been performed. In the past, numerous cases exist where dredging was performed only on the even 100-ft stations/sections surveyed by the USACE (usually by manual tagline/leadline techniques), and no material was excavated between the sections. Often this fraudulent work was not discovered until long after the work was accepted. Such incidents are rare today given full-bottom sweep capabilities of modern survey equipment.

10-8. Measurement and Payment Surveys Performed by Other than USACE Hired-Labor. On most projects, quantity survey measurements are performed by USACE hired-labor (in-house) survey forces. However, FAR and USACE policy provides for contractor-performed measurement and payment surveys. Often there are insufficient USACE survey personnel to cover surveying requirements for many ongoing construction and dredging contracts. Many contracts (e.g., beach renourishment and revetment construction) require full-time survey capability throughout the construction season; thus, it is more efficient to contract this effort.

a. When necessary, either independent A-E contractors or dredge contractor survey forces may be used in lieu of USACE surveyors. USACE policy regarding contracting measurement and payment surveys is prescribed in EP 1130-2-520, Navigation and Dredging Operations and Maintenance Guidance and Procedures. Basically, surveys may be performed using (1) USACE hired-labor forces, (2) Architect-Engineer (A-E) service contractor forces selected using Brook's A-E Act (PL 92-582) qualification-based selection procedures, or (3) Dredge contractor forces, provided a qualified government representative is on board the contractor's vessel during the surveying operation.

b. EP 1130-2-520 outlines a preference for performing surveys with USACE forces. This policy is justified in that payment and project clearance/acceptance is based on these surveys, and

any disputes (between the USACE and construction contractor) over survey adequacy or accuracy become difficult to resolve unless the contract agent is fully responsible for the survey data.

c. The use of construction/dredging contractors performing their own payment surveys represents a special case, given the need for quality assurance oversight that must be performed by the USACE when such surveys are performed. This oversight includes government inspection aboard the contractor's survey vessel and review of all data processing phases, including pay quantity computations. EP 1130-2-520 outlines steps that must be taken when a district elects to use dredge contractor forces for hydrographic payment/acceptance surveys. Basically, districts must provide a rationale and justification for proposing to use dredge contractor's surveys forces and

EM 1110-2-1003

30 Nov 13

document their unsuccessful efforts to obtain contracts with qualified independent A-E hydrographic survey firms. Guidance in EP 1130-2-520 notes that districts may require that a contractor's surveyor be a licensed land surveyor or hold hydrographer certification from the American Congress on Surveying and Mapping (now the National Society of Professional Surveyors). Certain minimum equipment specifications may also be required in the dredging contract.

d. Most dredge contractors normally have survey forces on the project to perform progress payment surveys, and these same forces can be used for payment and acceptance surveys as well. In some instances, dredge contractors will subcontract their hydrographic survey work.

SECTION I

Channel Clearance Surveys

Government channel clearance surveys should be expeditiously performed and processed, such that a preliminary evaluation of acceptable or unacceptable clearance can be made at least within 24 hours after completion of the survey, and preferably, concurrent with the survey aboard the vessel. In new work or deepening projects in hard material, authoritative government and contractor representatives may be present during actual clearance surveys so that potential strikes or shoals above grade can be immediately assessed and/or resurveyed, for either confirmation or acceptable clearance. In such cases, near-real-time data processing needs to be performed aboard the survey vessel at the project site so that additional verification surveys can be immediately performed over questionable areas. These expedited survey procedures are essential for contracted construction acceptance, clearing dredges to relocate to other project sites. Both mechanical and acoustic methods are used to verify channel clearance, as described below.

10-9. Definitions.

a. Strike detection or minimum channel clearance. For strike detection or dredge clearance/acceptance purposes, multiple "hits" on strikes or shoals above a specified grade are

required. Typically, the specified grade is the "Required Grade" although an overdepth grade or supergrade could also be used. An additional tolerance grade for rock cuts may also be specified. Multiple confirmation sweep passes are always recommended for channel clearance surveys in that strikes above grade detected from different sweep aspects helps to minimize the possibility of noise spikes creating false strikes on a single pass. The representative "shoalest depths" are used to generate "strike plots" depicting project areas remaining above grade, and the possible need for additional excavation.

b. Confirmed hits. The multiple "hits" may be obtained on a single sweep pass or (best) from multiple sweep passes over a suspected shoal/strike area. A USACE recognized rule of three (3) hits is recommended to represent a "confirmed" hit. This "3-hit rule" should not be arbitrarily applied, as it does not have a valid statistical sampling basis relative to the magnitude of the strike and the depth measurement uncertainty. The "multiple hits" above grade are determined by assessing "minimum" edited depths recorded in a cell matrix, or from a series of adjacent cells. Three

confirmed hits within various cell sizes are used; however, adjacent cells may need to be assessed if only sporadic hits occur in a single cell.

c. Strike plots--plotting minimum hits above grade in plan. If many shoals/strikes exist in bins over a small area, then the processing software will have to select the most representative (e.g., highest/shoalest) confirmed strike to plot for this area--to avoid overplotting depths at the plot scale. If contour or color-coded depth plots are generated, then all the minimum confirmed hits can be easily represented in plan or 3D format.

10-10. Channel Clearance Bar Sweeps. (Figure 10-4). A bar sweep is a non-acoustic technique for clearing channels or determining the elevations of underwater obstructions. In rock cut channels, a heavy bar or pipe may be dragged along the bottom by a tug to knock down spikes or smooth out the grade. In this case, no elevation of the bar is maintained and acoustic surveys are still required to verify clearance. Elevation controlled channel sweeps are performed using sweep rafts or sweep barges. A bar is lowered to a controlling grade elevation and the channel is "swept" clear by the bar to ensure safe navigation. A bar sweep has particular application in blasted or cut rock dredging construction where hull clearance verification is especially critical. In many cases, a bar sweep represents a more reliable clearance verification than that obtained by acoustic methods. Bar sweeps were once more prevalent in USACE but currently are rarely employed, except in special cases where channel clearance is critical. The following paragraphs describe the bar sweep process that was once used in the Detroit District. These same techniques (or modifications thereto) could still be employed should a need arise on a current project.

a. Background. The Sault Ste. Marie (Soo) Area Office (Detroit District) began deploying sweep rafts in the St. Mary's River (MI) around 1930. The purpose was to certify clear grades in the approach channels around the Soo Locks. Channel depths swept vary from 27 to 30 ft. The original channel was designed based on a design draft of 25.5 ft. Channels in hard rock areas are cut to 28.0 ft with very little overdredging below that level due to the hard material.

The channels that produce the most dangerous grounding hazards to commercial vessels are those constructed in native bedrock. The next most dangerous channels are those cut through glacial deposits containing boulders. Commercial vessel groundings in other channels constructed in soft material have not proven significant. Vessel loadings are driving the need to clear the channels free of navigation hazards. Commercial ore carriers will typically load close to the 28.0 ft level, typically to 0.3-ft clearances above the swept clear grade reported by the Corps. Groundings on commercial vessels have occurred on the west approach to the Soo Locks due to loading too close to the cleared grade.

b. Detroit District sweep raft design. The Detroit District operated four sweep rafts on the Detroit River, St. Claire River, and St. Mary's River. They were wooden rafts or barges 120- to 130-ft-long, with a 15-ft beam and 4-foot draft. The sweep system dragged six, in-line, 21-ft-long by 2.5-inch diameter solid steel bars, each bar weighing approximately 600 lb. This resulted in a clearing swath of some 120-ft. The bars were suspended by a 3/8-inch diameter cable wound on manually operated reels designed to raise and lower the bars by 0.1-ft

EM 1110-2-1003

30 Nov 13

increments. The bars are suspended along the center of the sweep raft with a 1-ft overlap between adjacent bars.

(1) Three observers were required to monitor the sweep bars--each person responsible for two bars. Concurrent river stage observations are required to continually adjust the depth of the bar. Sweeping is done at a slow speed (slightly greater than drift velocity) in order to keep the bar(s) suspended vertically at the proper depth. Strikes are detected by manual feel of vibration in the cables suspending the bar. When the bar "strikes" a hazard, the position is fixed and the height above grade determined. Individuals monitoring the suspended cables are able to determine the relative hardness and softness of a struck object by feel and sound in the wires. The raft is towed, pushed, and maneuvered by a 45-ft harbor tug. The tug requires a two-person crew. The tug was traditionally powered by a 170 HP engine using low power to avoid dragging the head anchor. Control of the sweeping is done using a headwire anchor about 600 feet upstream, as shown in Figure 10-5. The tug drops the anchor, connects to the towline, and the sweep pulled downstream to the sweep area while letting out cable. Sweeping is performed with the tug attached to the fixed-length tow line, the sweep and tug held by the anchor to prevent them from going downstream, and pulling the sweep back and forth on the cable. The length of the cable payed out represents the radius of the sweep. Sweeping begins at one side of the channel. The bars are wheeled down, set at depth, and corrected for river stage. After each swept arc, an additional 100 ft of cable is payed out downstream and the next arc swept. This provides a 20-ft overlap between successive sweep arcs. Upon completion of sweeping, the cable is picked up onto the drum of the hoist and the anchor brought back aboard.

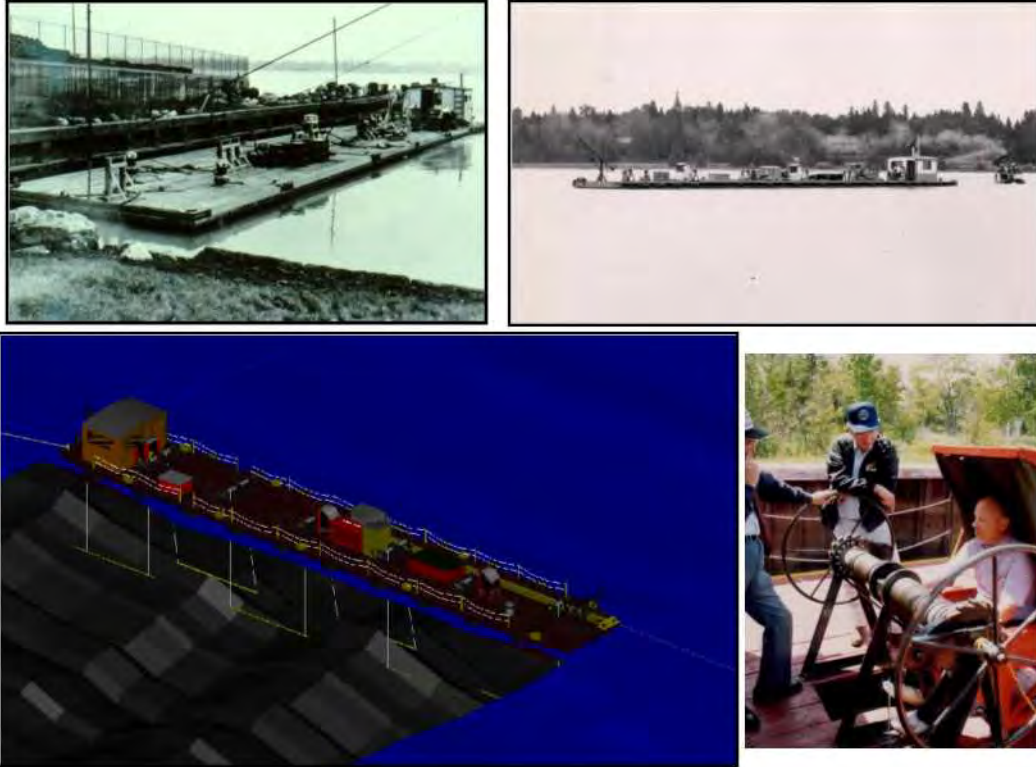

Figure 10-4. 130-Ft Sweep Raft on Detroit River (upper left) and St. Marys River (upper right). The concept sketch on lower left shows the six 21-ft sweep bars. “Chairpersons” (lower right) manually feel rock “strikes” from vibrations on the cables. (Detroit District)

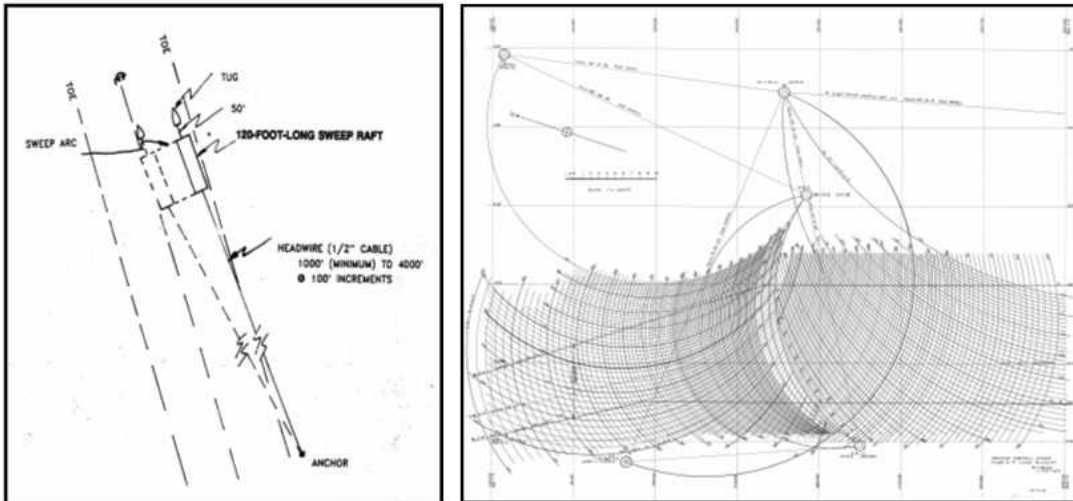

Figure 10-5. Sweep raft control from upstream head anchor (left side). Constant sextant angle curves were once used to position the sweep raft and locate strikes (right side).

EM 1110-2-1003

30 Nov 13

(2) Horizontal positioning was accomplished using sextant resection from fixed targets along the river bank, and later microwave electronic positioning. For sextant positioning, an "arc chart" of the channel was prepared consisting of two families of constant sextant angle circles (Figure 10-5). Positions of the beginning and end of the swept arc are determined by sextant resection. When a strike was detected, the resected position from two observed sextant angles could be quickly plotted aboard the sweep raft.

(3) Locations of any snagged obstructions (i.e., strikes above grade) are positioned, and the pinnacle or obstruction elevation is measured by sweeping at successively higher elevations until it is cleared. It is estimated that the accuracy of mechanical sweep raft measured elevations was 0.2 ft. A "strike plot" is prepared showing all contacts encountered. Sweep rafts often work in conjunction with a derrick barge or crane barge to remove strikes. A derrick barge clears the strike either by dragging a bar over the area or by blind pattern digging with a clam shell bucket.

(4) The total crew required for a sweep operation was nine persons. These includes a Party Chief, Sweep Foreman, two tug boat operators, three bar sweep tenders ("Chairpersons"), an on shore gage reader, and one relief person.

c. Replacement sweep clearance systems. In the mid to late 1980s, the Detroit District began using 32-transducer (130-ft) multiple transducer systems to sweep the Detroit River and St. Marys River, replacing the above mechanical detection system. Subsequently, around 2002, this 32-transducer multiple transducer system was replaced by a multibeam system permanently hull-mounted aboard a trailerable boat. Although labor-intensive and slow relative to current acoustic methods, these bar sweep systems provided reliable, certifiable channel clearance verification in rock cut areas. Many contend these older bar sweep methods provide a more definitive (and confident) clearance assessment than acoustic techniques. In fact, the Detroit District Soo Area office still deploys a small, single-bar sweep on the Derrick Barge Nicolet working the St. Marys River (Figure 10-6). The derrick barge is also equipped with a multibeam system. It is supported by a multibeam boat that locates potential strikes and provides "strike plots" to the derrick barge (Figure 10-7).

d. Wire sweeps. Wire sweeping methods were once commonly performed by the U.S. Coast & Geodetic Survey and the USACE Lake Survey District for sweeping wide areas, usually in deeper (non-maintained) approaches to navigation projects. Wire sweeps were not considered as reliable as the bar sweep methods described above. The USACE Lake Survey District last performed wire sweeps at Cleveland Harbor, Lake Erie, in the early 1970s.

10-11. Acoustic Evaluation of Clearances on Dredging Projects. Multibeam systems are now the primary method used to verify channel clearance, especially in deep-draft, rock cut projects. (Single beam surveys may be used on maintenance dredging projects with soft material.) Multiple sweep passes are performed over the channel and the data binned into small grid cells for evaluation. Typical cell sizes on clearance evaluation surveys range from 1 x 1 ft to 5 x 5 ft.



Figure 10-6. Detroit District Derrick Barge Nicolet. The barge deploys both a single bar sweep and a multibeam system to aid in object detection and removal.

a. Strike verification (new work or rock). When multiple adjacent/contiguous cells on a single acoustic multibeam survey sweep over an area contain multiple depths above the required grade, then a confirmed strike above the required grade may be inferred, and additional dredging clearance may be indicated. When an isolated cell indicates a single depth above the required grade, further confirmation should be made to verify the strike by making at least two (2) or more additional “dead slow” survey passes [sweeps] over the suspected strike area, i.e., slow enough to accumulate a statistically significant number of depths from which to evaluate the confidence of the average representative depth.

b. Shoal verification (maintenance dredging/soft bottom material). When adjacent/contiguous depths on a single acoustic survey (single-beam or multibeam) over an area contain multiple depths above grade, then a confirmed shoal above grade may be inferred and additional dredging clearance may be indicated. When an isolated depth above grade is recorded, further confirmation should be made to verify the shoal by making at least two (2) additional slow speed passes over the suspected shoal area in order to accumulate a statistically significant number of depths from which to evaluate the confidence of a representative clearance depth.

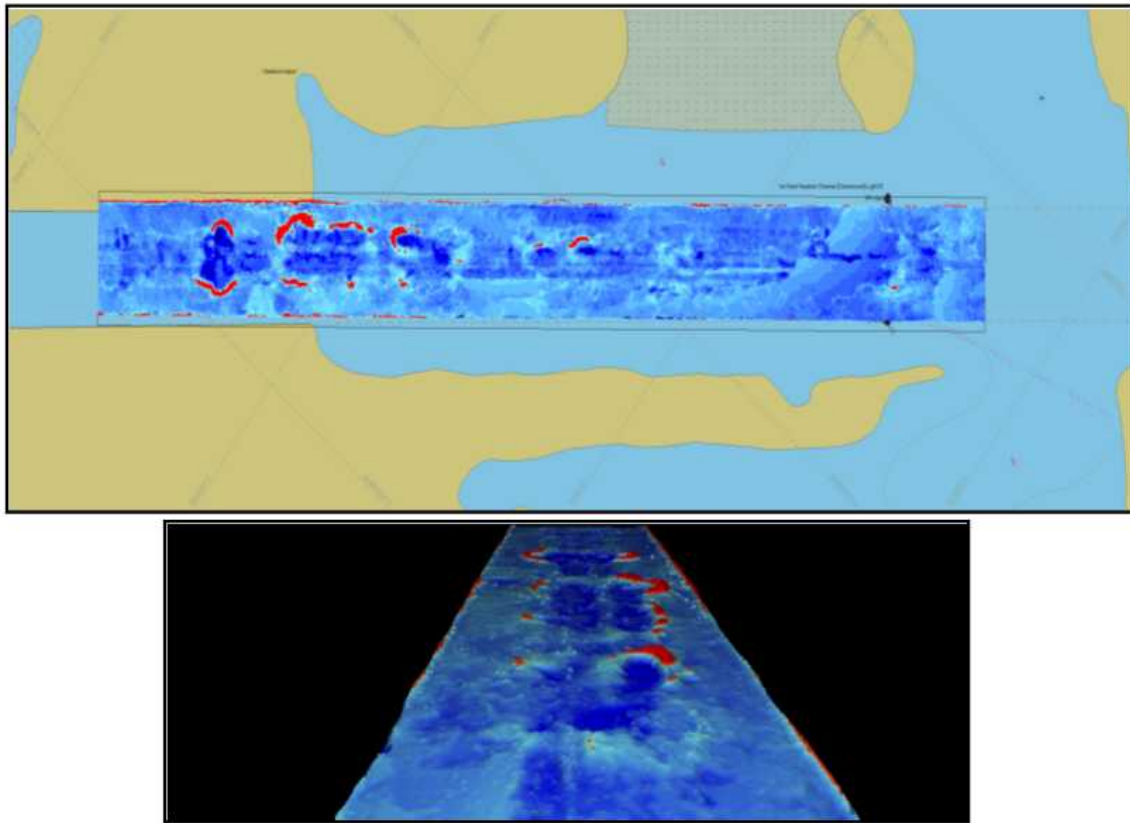

Figure 10-7. Strike plot of rock above grade in the St. Marys River channel. Reson 8125 multibeam survey by S/V Bancroft W. Bufe, Detroit District, Soo Area Office (2004)

c. Minimum number of recorded depths for assessing clearance. A minimum of 3 depths above grade is usually considered as indicating the presence of a shoal or strike—i.e., the so-called "3-hit rule." Depending on the magnitude of the strike above grade, this "3 hit rule" may not be statistically significant relative to the uncertainty of the individual depth measurements. For example, 3 depths 1 ft above grade may be significant whereas 3 depths 0.2 ft above grade may not be. Clearance depths should be assessed considering the confidence of all the measurements in a cluster or cell.

(1) Most object detection criteria typically specify that a minimum number of acoustic "hits" be obtained on a potential shoal or strike. These hits should ideally be obtained on repeated passes over an object, and be recorded on each pass. A single pass is adequate if numerous hits above grade are obtained, the strike elevations are consistently above the required grade, and the magnitude of the strike is within the accuracy of the depth measurement system.

(2) Evaluating channel clearance on dredging projects involves a review of the soundings obtained on the final after dredge survey and/or final channel clearance sweep survey. Numerous

shoals or strikes above the required grade may be present on these surveys. The project manager or contracting officer's representative (COR) must ultimately determine whether these shoals/strikes above grade warrant additional work effort to assure project clearance, or they are isolated, stray soundings within the "noise" (i.e., uncertainty) level of the depth measurement system. Therefore, this assessment of above-grade soundings must consider (1) the error budget (uncertainty) of individual depth measurements, (2) their relative magnitude, (3) survey accuracy standards specified for the project, and (4) the detection repeatability of the acoustic system.

(3) A single recorded "hit" 0.1 ft to 0.2 ft above grade presents clearance assessment problems. This hit could be the edge of a shoal or rock of larger size with even a shoaler elevation. If the estimated RMS uncertainty of the depth measurement system is ± 1.0 ft, then this small strike could be an observation lying within that 95% accuracy tolerance--e.g., taken when a vessel without heave compensation was surging down in the trough of a wave. Thus, additional observations are needed to confirm the existence (or non-existence) of material lying above the project grade. Additional passes over the area are thus required. If acoustic hits above grade are repeatedly obtained on these additional passes, then a high probability exists that a shoal or rock strike is present in the channel. The confidence levels of shoal detection can be roughly estimated given (1) height of hits above grade, (2) standard deviations of depth measurements, and (3) number of hits. Using approximate t-density functions, it can be mathematically shown that all three of the above factors (variables) will determine the overall confidence of detection. For example, given 3 hits averaging 1-ft above grade and a ± 1.0 ft standard deviation, the detection confidence is roughly 75%. If only 2 hits were recorded, the confidence of a shoal drops to 60%. If 10 hits are recorded, the confidence of detection increases to 98%. Thus, obtaining a 95% detection confidence may require more than "3 hits," depending on the magnitude of the three variables described above.

(4) Obtaining multiple hits with a single beam (narrow beam) echo sounder is difficult. Stealth-like objects may not always be detected with vertical beams. Close line spacing must be run over a suspected strike--e.g., 10 ft to 20 ft intervals. A multibeam system is far more efficient in detecting strikes and confirming them with multiple passes. Multibeam sweeps should be conducted such that the beam aspect is varied from near vertical to an outside beam. The outside beams have a better chance of detecting vertical, stealth-like objects above grade. Multibeam side scan imagery on the outer beams will also be of value in detecting strikes above grade. A towed side scan can also be used to indicate potential objects; however, it will not provide clearance depth information—see Appendix Q.

(5) For a detailed analysis on object detection with multibeam systems see "Provisional Swath Sonar Survey Specifications" (LINZ 1999). This specification analyzed detection criteria used by various international hydrographic surveying agencies and proposed that "at least 'three strikes' on the minimum target dimension be provided in both the along and across track dimension." This specification also qualifies other critical factors in strike detection, such as vessel speed, frequency, beam spacing, and footprint size. No statistical basis was given for this

EM 1110-2-1003

30 Nov 13

"3 strike (hit)" specification; its proposed adoption was based largely on field survey experience. This analysis is, to some extent, consistent with the USACE recommended use of a "3-hit rule" detection method.

(6) Figure 10-8 illustrates the difficulty in evaluating small recorded heights above grade, given the noise of the depth measurements and their ± 0.8 sample (61 depths) standard deviation. (This ± 0.8 deviation is not necessarily the TPU (TVU) of the depth measurements since other biases could be present.) This apparent uncertainty in the observed depths must be considered in evaluating whether isolated depths above grade are realistic. In this example, given the preponderance of depths below the 42.0 required grade, the two isolated depths above grade are likely noise and would be rejected. If the required grade was 42.2 ft, then only 6 of the 61 depths are above grade, and the existence of a shoal is still statistically problematic. However, if the required grade was 42.4 ft, then a significant number of depths (12 of 61) above that grade would indicate a likelihood of a lack of clearance.

d. The relative height of an object or shoal above grade will determine the need for clearance. This may depend on the location of the shoal within the channel, type of bottom material, size of shoal, potential navigation hazard, etc.

e. Object and shoal/strike detection criteria. A detection performance criteria should be specified based on the size of the minimum object being searched for in a particular project, using either mechanical bar sweeps or acoustic sweeping/scanning methods. Demonstration testing of an acoustic detection system's capability should be specified on critical projects. This would entail deployment of an artificial object with the required dimensions. A minimum of three acoustic returns from a shoal or object should be specified to confirm its existence. These acoustic hits may be obtained on a single pass or, more conclusively, over successive passes. Reconfirmation of a strike above project grade by successive passes on different courses is strongly recommended for dredging clearance surveys.

f. Evaluating clearance depth uncertainties in multibeam cells. The uncertainty of the resultant average of a series of depth measurements over a fixed area is usually represented by the estimated standard deviation of the resultant mean—i.e., the "standard deviation of the mean" or "confidence level." This statistical estimate of dispersion may be applicable when multiple depths are grouped in a defined bin, cell, or DTM node, as is done on multibeam dredge clearance assessment surveys. The multiple depth measurements in a defined cell area may have been obtained from a single pass by a multibeam system or accumulated from different multibeam passes on different days—see example cell data at Figure 10-9. In this example, the standard deviation of the 59 depths in the cell sample is ± 0.8 ft (95% or 2-sigma). The 95% confidence of the representative 42.2 ft average depth may be estimated based on the standard deviation of the mean.

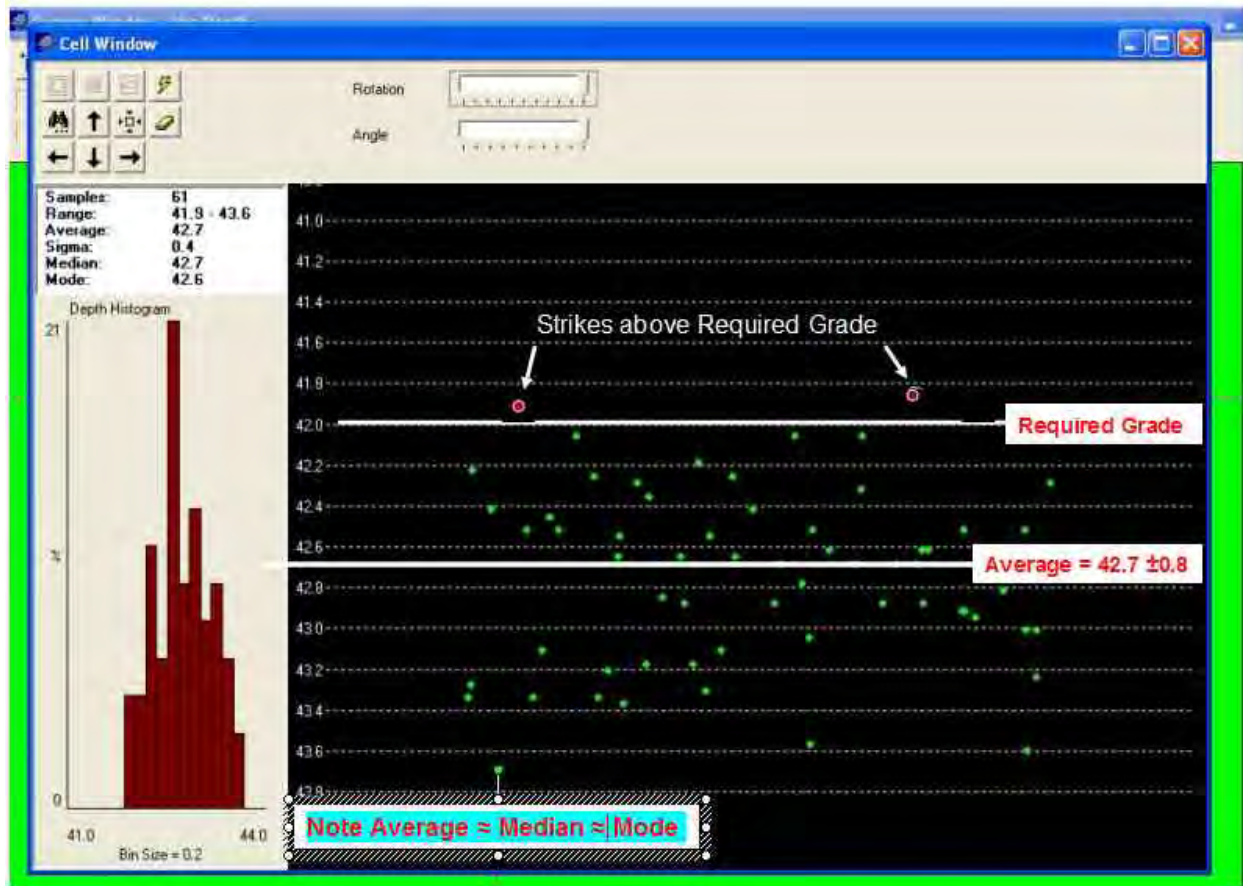

Figure 10-8. After dredge clearance survey. Typical dispersion of 61 multiple depths recorded in a 3 ft x 3 ft cell. Two depths recorded above 42.0 required grade. Sample standard deviation of 61 depths is ± 0.8 ft (95%).

(1) The scattered dispersion of depths in Figure 10-9 clearly illustrates why a statistical evaluation is necessary to evaluate dredged clearance, and that none of the individual depths can be conclusively selected to represent the cell.

(2) Depending on the number of depths in a cell, the confidence of the mean will be less than the estimated standard deviation of the individual depths. This is why repeated surveys (performed over different days, tide phases, or even with different vessels) over a suspected shoal or strike will generally “repeat” or “reproduce” each other to the 0.2 to 0.5 foot level when the average representative depth is evaluated, even though the dispersion (standard deviation) of the individual depths in the cell may be ± 2.0 ft. As the number of depths in a cell increases, the more confidence in the mean is obtained. Although in theory the confidence level of the average

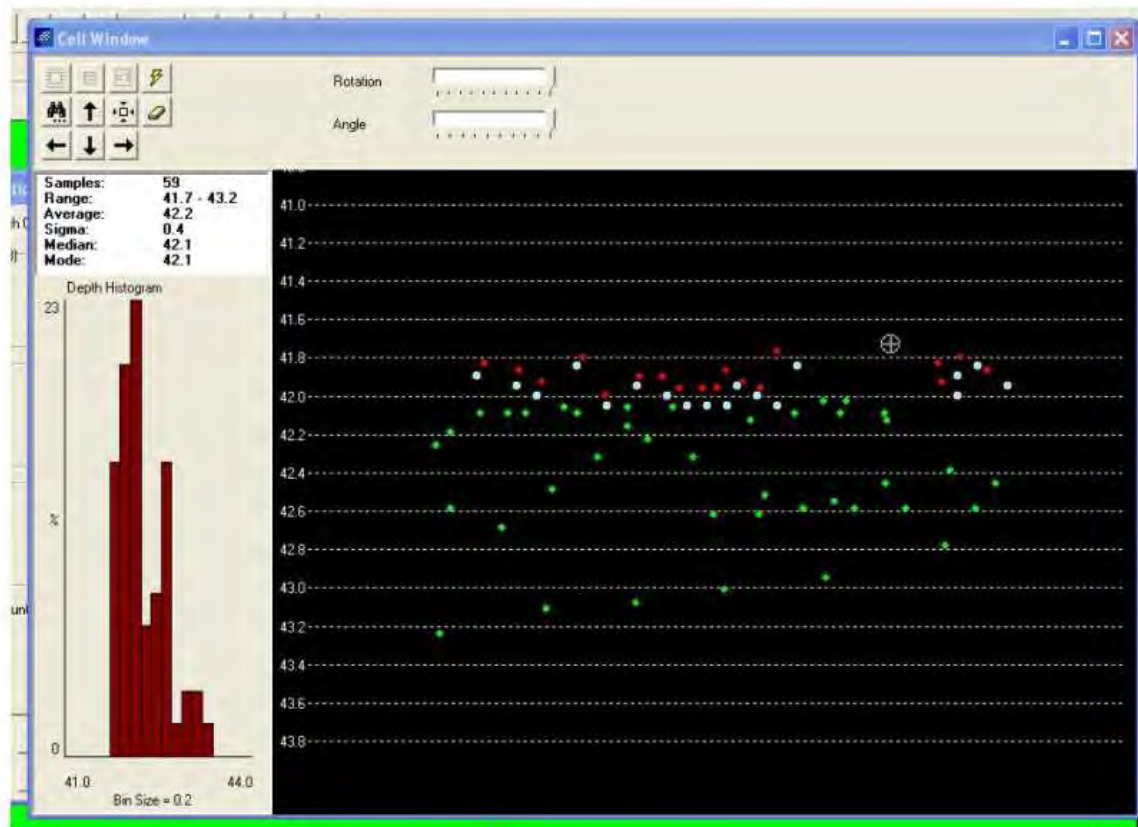

Figure 10-9. Typical dispersion of 59 individual multibeam depths observed in a 3-ft x3-ft cell—multiple passes over a suspected strike in a rock-cut turning basin. Red, white, and green depths were obtained on different passes—their apparent biases likely due to being recorded on different angles of the multibeam array. Depths above the required 42-ft grade are statistically significant in this example. Miami Harbor—Jacksonville District (2006)

depth in each cell could be evaluated (computed), such a procedure is currently not a practical engineering option—an estimated confidence based on an average measurement repeatability needs to be established for a given survey and project site.

(3) Cell size. There is no statistical significance for the USACE recommended cell sizes of 1x1, 3x3, or 5x5 ft. These cell sizes represent practical engineering practice so that consistent clearance and pay computation practices can be performed Corps-wide. In the future, more statistically relevant procedures may be developed.

(4) Number of sample depths in a cell sample. The more depths that can be collected in a defined cell, the more reliable is the precision/confidence statistic computed based on the average cell depth over a flat bottom. In critical channels (rock or hard clay), the vessel speed

should be minimized over suspected strikes above grade, and multiple passes made over the strike using different aspects of the multibeam array. In this manner, 20 to over 100 depths may be

collected within a 3- x3-ft cell—over 30 typically being considered statistically significant, although lesser numbers will still have validity for strike assessment. In large samples, the average representative depth in the cell will have maximum validity for clearance assessment, or hypothesis testing if multiple depth levels appear—i.e., a CUBE type analysis outlined below. For practical engineering use, a fixed criteria for the minimum number of depths in a cell is usually specified.

(5) Average or median representative depth. When large samples are available in a defined cell, the difference between the statistical mean (average) depth and the median depth will be insignificant, and is not likely to bias over an entire project area. Thus, either value may be selected as the representative (and reported) clearance depth for the cell. When an even number of depths result in the cell, the representative median depths must be computed as the average of the two depths closer to the median, or the first occurring depth may be selected. Given the typical echosounder footprint size, coupled with the horizontal positioning uncertainties, in small cell sizes the horizontal location of the actual median depth may be ignored—use the cell center (centroid) at the location for the represented depth. Better results are usually obtained when a matrix cell spans a toe line and the median depth can be saved in its exact location, whereas the average depth is moved to the center of the cell. Many USACE districts recommend use of median depths rather than averaged depths.

10-12. Evaluating Clearance Grades in Unconsolidated Material. See Appendix P for guidance on evaluating clearance grades in suspended sediments, fluid mud, and other unconsolidated materials.

10-13. Side Scan Sonar. Side scan sonar is a high resolution tool that provides a general depictive map on both sides of a survey vessel's path. Side scan sonar will not provide absolute elevations of objects above a defined grade. It will provide relative heights of objects off the surrounding sea floor, from which an approximate top elevation may be roughly estimated. Side scan sonar can provide acoustical pictures of the sea floor, usually in digital format. Actual applications on dredge clearance surveys are limited, especially in rock cut channels. This is because numerous rocks will be detected, many of which will be below grade—side scan sonar records cannot distinguish between rocks above and below grade. Towed side scan sonar systems, or multibeam data coupled with backscatter data, have application in visualizing potential strikes above grade. Details on side scan sonar theory and applications are contained in various publications and manufacturer references. For information on side scan survey specifications, refer to Appendix Q, and "NOS Hydrographic Surveys Specifications and Deliverables" (NOS 2011) and the NOAA "Field Procedures Manual," (OCS 2011).

10-14. Combined Uncertainty and Bathymetry Estimator (CUBE). Statistical hypothesis testing algorithms, such as CUBE, may be of use in evaluating the potential existence of strikes or

shoals above grade. See "Automatic Processing of High-Rate, High-Density Multibeam Echosounder Data" (Calder and Mayer 2003). CUBE is especially useful in locating multiple depth clusters in a defined region (node or cell) that may indicate isolated strikes above grade but are masked by an average or median depth. CUBE also develops a most probable representative depth (or multiple hypothetical strike depths) at each nodal location, along with an estimate of its statistical uncertainty—Figure 10-10. The estimated depths selected by CUBE generally represent a

EM 1110-2-1003

30 Nov 13

median subset of the input data. Those depths should NOT be used to determine the presence of shoals in the survey area. The user should examine nodes with multiple depth estimates to determine if a possible shoal exists that might require further examination. CUBE is recommended as a detection tool on critical projects involving rock near the project grade. See also "The Navigation Surface and Hydrographic System Uncertainty at NOAA's Office of Coast Survey," (NOAA 2005). CUBE analysis of datasets, and searches for potential strikes above grade, can be run from edited multibeam survey data processed through the HYPACK "HYSWEEP CUBE" utility software option. Details on running HYSWEEP CUBE and analyzing results are available in the HYPACK User Manual (HYPACK 2011).

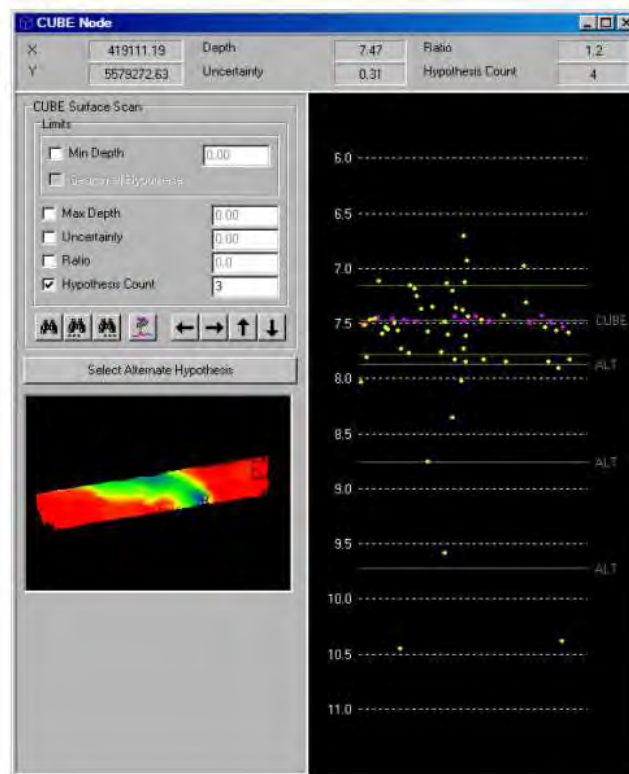

Figure 10-10. CUBE selected depth at 7.47 m with uncertainty boundary (± 0.31 m). Three alternate depth hypotheses are also generated by CUBE, with higher uncertainties.

SECTION II

Dredge Payment Volume Calculations

The following paragraphs describe the general concepts and methods used in computing volumes from single beam and multibeam surveys. This section is only intended to give an overview of the computational quantity take-off procedures used in the Corps of Engineers. Detailed descriptions of

construction volume computational methods are covered in various surveying and engineering textbooks. Procedural methods are described in CADD software manuals and USACE PROSPECT courses.

10-15. Dredge Quantity Computation Techniques—Background. A primary use of hydrographic surveys supporting river and harbor construction is to determine the quantity of material that is excavated or placed. These material quantity estimates are used for design/bidding purposes and contracted construction payment. The following sections deal with the computation of dredged quantities (either excavated or placed) as determined from in-place hydrographic surveys. Other methods of estimating dredged quantities (scow/bin load measurements, production flow rates, station/face cut dredging, etc.) are not covered.

a. In general, all commonly used volume computation methods for estimating excavated or placed material reduces down to that of determining the area bounded by a finite group of data points and projecting this area over some length to obtain a prismatic volume. These projections may be done either horizontally or vertically, as shown in Figure 10-11. The methods used in the USACE for dredged material are:

- (1) Average End Area (AEA).
- (2) Surface Differencing or Triangulated Irregular Network (TIN).
- (3) Grid or Bin.

b. Figure 10-11 illustrates the general differences between these three computational methods. An overview of each method is outlined in subsequent paragraphs. Later sections in this chapter cover the first two methods in more detail.

(1) In Figure 10-11, the AEA volume is a function of the horizontally projected areas of each cross-section—A1 and A2 -- projected along the distance (L) between the two sections. An approximate volume results from this AEA computation. When TIN prismatic elements are generated for data points between the two cross-sections, the volume of each prismatic element can be computed given the X-Y-Z coordinates of the three vertices--i.e., observed depths converted to elevation differences above (below) the reference channel surface/prism. The resultant volume computation is more accurate than the AEA method. This is particularly true if

the bottom is above design depth at one end of the prism and below design depth at the opposite end of the prism. One source of error in AEA is that depths are moved perpendicular to the planned line, whereas TIN models use the exact position of each depth.

(2) If full-coverage binned data are available, then the vertically-projected volume of each grid cell can be computed given the cell area on the reference surface (A) and the elevation (h) of the cell depth above (or below) that reference surface. The cell surface area is either the grid size or that based on TIN vertices, as shown in Figure 10-11. TIN vertices can be determined between dense

EM 1110-2-1003

30 Nov 13

bins – Figure 10-11 shows only TINs generated between cross-sections. Given the higher-density coverage, this is the most accurate volume.

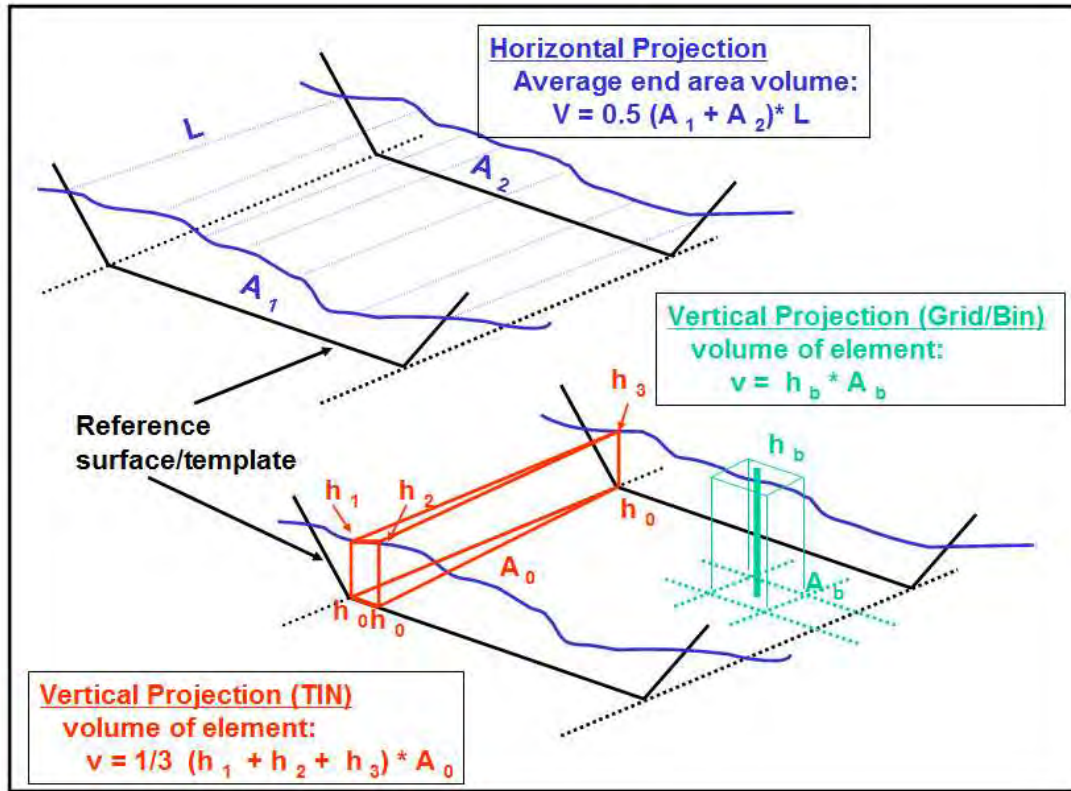

Figure 10-11. Generalized depiction of Average End Area, TIN, and binned volume computation methods. Note that TIN models may be generated between either cross-sections (as shown) or densely gridded bins (not shown).

10-16. Average End Area Method. Dredge quantity computation procedures in the USACE for dredging work originated from methods used in railroad and roadway construction—i.e., the “Average End Area” (AEA) method. Topographic, tag line, or single beam cross-sections of a channel are taken at prescribed intervals, the area of material in each cross-section is computed, and the volume of material computed by projecting the cross-sectional area along the alignment.

a. The AEA method is used by most USACE offices to compute payment volumes for contract dredging work, in particular for single beam surveys. Although this method is well known to be only an approximation, and contains biases, its use is widely accepted within the USACE and the dredging industry. Large biases in computed material can be generated by the AEA method when material is located primarily on the inside or outside of a turn in the channel.

b. The major AEA assumption is that the cross-sectional area is relatively constant between two successive cross-sections. If not, then this method becomes an approximation (or estimate) of the true volume. Decreasing cross-sectional spacing to improve the AEA computation accuracy had

economic limits due to increased field survey costs. Thus, cross-sectional spacing for most dredging work ranged from 100- to 500-ft throughout the USACE.

This cross-section spacing was (and still is) usually adequate in maintenance dredging projects involving soft material. Better estimates of volumes can be achieved on non-parallel lines by using separate distance-between-lines for the side slopes and center channels.

10-17. Surface Differencing Methods—“TIN Models.” Since the 1970s, multiple-transducer sweep systems, and later multibeam systems, have provided a dense, full bottom coverage of a channel, allowing for more accurate quantity take-offs than those using only sparse, single beam 100- to 500-ft cross-sections. Multibeam binned matrix files can be converted into TIN models, which can be compared against a 3D model file of the channel framework template to obtain quantities—i.e., “surface differencing” volumes. TIN models can also be derived from cross-section surveys. Quantities from TIN models can be still computed using the AEA method if cross-sections are mathematically generated from the TIN model; however, this is not recommended—see Section IV for alternate options.

10-18. Grid or Bin Vertical Projection Methods. Vertically projected bins from a fixed grid network are occasionally used to compute volumes of borrow areas and reservoirs. It is not commonly used to compute dredged quantities. As shown in Figure 10-11 this is not materially different from the TIN method and quantity estimates should be fairly similar since TIN methods typically originate from the same binned data (assuming the same average or median elevation of the bin are the same for both methods).

10-19. Average End Area Computation. For most USACE construction and dredging work, the horizontally projected average end area (AEA) method illustrated in Figure 10-11 has been the recognized volume computation method when cross-section data has been surveyed.

a. Accuracy. AEA volumes are generally accurate in straight trapezoidal channels with minimum topographic irregularity. However, in projects with varying dimensions and high topographic irregularity, it is recognized that surface differencing TIN methods yield far more accurate quantity estimates than AEA methods. This is mainly due to the inherent approximations in AEA methods.

b. Computation variations in USACE. Currently there are numerous dredged quantity computation methods, options, and reporting variations unique to USACE Districts, and even separate regional Area Offices. These variations involve nuances (and often unnecessary complexities) in overdepth allowances, dredging limits, side slope allowances, box cuts, and reporting formats. These individualized payment methods have necessitated duplicative procurement of dedicated software (and training) by the USACE and dredging industry personnel.

c. Volume reporting tabulations. For contract bid estimates, volumes within dredging acceptance sections are usually tabulated relative to cross-section intervals within each section. When AEA methods are used, accumulated required and overdepth quantities are easily

EM 1110-2-1003

30 Nov 13

determined. Surface differencing TIN volumes can be broken down to section-by-section volumes to obtain equivalent AEA volumes between sections. Software procedures have been developed to perform this breakdown—i.e., the HYPACK "Philadelphia District" method described in Section IV.

d. Contract specifications. Dredging contract specifications should clearly spell out the volume computation method used for payment, including the version of the software, and any special settings for the treatment of side slope, overdepth, infill, and over-dredged material. Failure to specify these parameters can result in unnecessary disputes over pay quantities.

10-20. Reference Surfaces and Payment Templates used in USACE. There is variation among USACE districts in dredge payment methods or templates. Even Area Offices within districts are known to have unique templates and payment methods. There at least a dozen distinct dredge payment methods used by USACE districts--e.g., Jacksonville Method, Grand Haven Area Office Method, Philadelphia Method, Savannah Method, etc. This variation adds complexity to attempts to standardize quantity computation software. Figures 10-12a and 10-12b depict the two most common in place payment methods found in the USACE.

a. The difference between the two payment methods is how material between the project grade and overdepth payment grade is handled. Neither method pays for material excavated below the overdepth grade—i.e., “Non-Pay” or "Over-Dredged" material. Both methods do pay for material excavated below the design grade (down to the overdepth grade) provided the Predredge (or P&S) survey indicated material existed above the design grade. If the Predredge survey indicated the area was clear to the design grade, then the Contour Dredging Method would not allow payment for material excavated below the project grade in that area. The Non-Contour (or Bordered) Method will provide payment allowance for material removed in this area. Thus, for the Contour Method, dredging payment limits are defined by the project grade depth contour for the Predredge survey; the dredging pay limit for the Non-Contour Method is defined by the overdepth grade contour for the Afterdredge survey. Some districts using the Non-Contour Method will place physical dredging limits within the channel for areas below project

grade—i.e., “Border Files.” This is, in effect, another form of Contour Dredging except the rigid dredging limits are used instead of the Predredge contours.

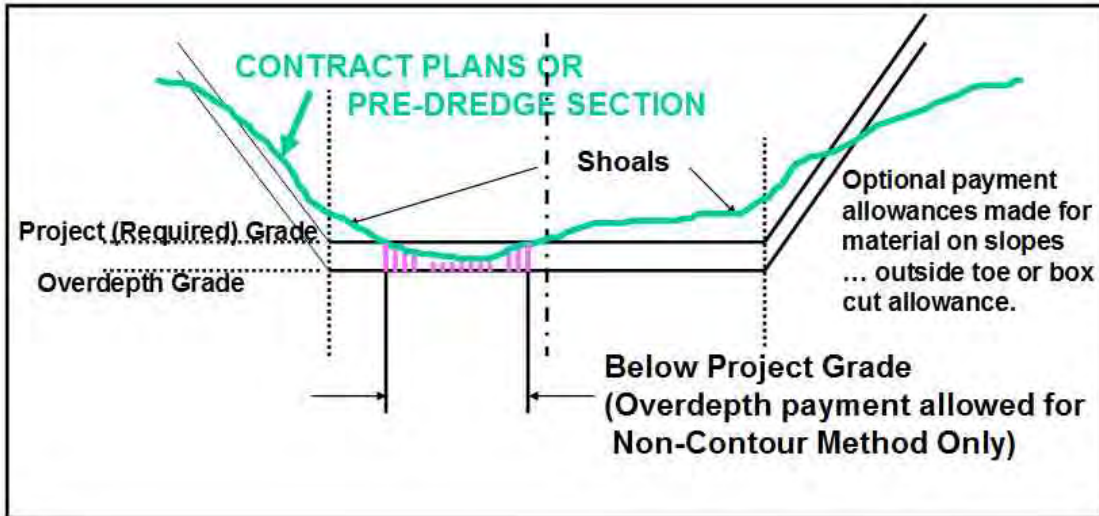

Figure 10-12a. Section view of Contour and Non-Contour dredging payment template. Contour dredging does not pay for overdepth in the shaded area where the grade is clear. Non-Contour dredging will allow payment for this material.

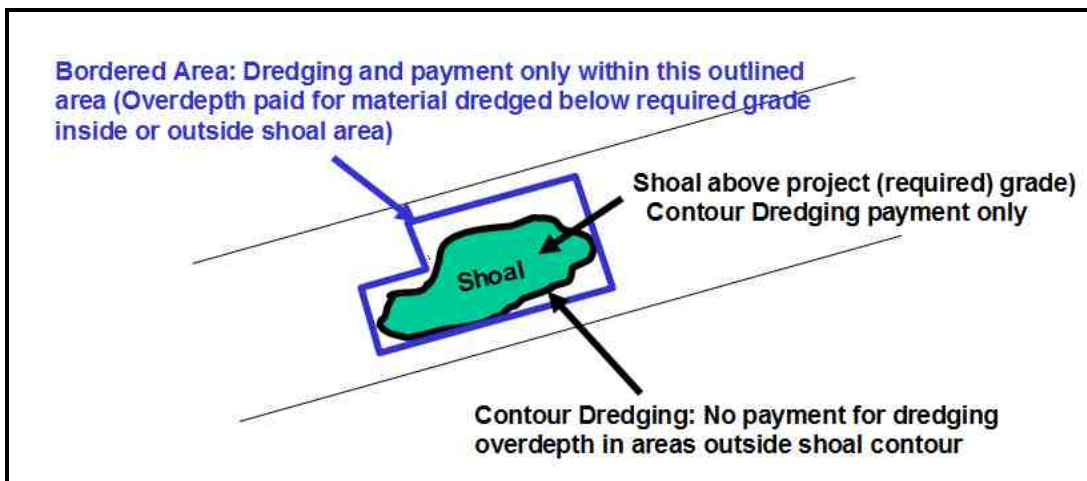

Figure 10-12b. Non-Contour (Bordered) Method: Payment allowed for material excavated above Overdepth Grade. Contour Method: Payment allowed for all material excavated above Overdepth Grade if shoal material exists above Project Grade.

b. Side slope payment. Districts vary widely on payment for excavation in side slopes. Some districts treat side slopes the same as the main channel, and pay relative to the Bordered Method or Contour Method. Others do not allow payment for any material removed from the side slopes (presumably such removal is factored into the unit price in the main channel). Some districts

EM 1110-2-1003

30 Nov 13

provide side slope excavation payment only on new work, not on maintenance dredging projects. Other districts provide for a box cut payment allowance described in Section III.

SECTION III

Average End Area Computation Methods

This section provides additional details on the Average End Area method used for estimating dredged quantities. As stated in the previous section, there are a variety of computational methods used throughout the USACE. Likewise, numerous software platforms are used, such as MicroStation, AutoCAD, and HYPACK. This section primarily illustrates the software techniques in the HYPACK "CROSS SECTIONS AND VOLUMES" (CSV) module since it is tailored specifically to dredging work, and is more commonly used by USACE districts and dredge contractors for volume computations.

10-21. Background. Traditionally, earthwork or dredging quantities for purposes of design estimates and construction payment have been obtained from cross-sectional topographic or lead line surveys of the project area. Survey data were recorded in field books. These surveys were normally run perpendicular to the general project (channel) alignment at a predetermined constant spacing. The elevation data were then manually plotted in section view along with the design/required depth and/or allowable overdepth templates. One or more reference or payment templates were plotted on these section views, e.g., required and overdepth templates. Given large scale sectional plots (e.g., 1 inch = 5 ft) of both preconstruction and postconstruction grades (or, in some cases, intermediate partial construction grades), the amount of excavated (cut) or placed (fill) area could be determined at each cross section, usually from coordinate computations or polar planimeters that measured the area between grades and templates. The areas at two successive cross-sections were computed, and the average of these end areas projected along the project alignment (linear or curved) by a distance equal to the sectional spacing, resulting in an approximate estimate of the volume of material cut or filled during construction. This approximate estimating technique is known as the trapezoidal or average-end-area method and is universally used (and accepted) in highway, railroad, and marine construction for design estimating and payment purposes.

a. Average End Area computation formulas. Given two successive cross sections of end areas A1 and A2, and a spacing distance L apart, the equation for an average end area volume between two cross sections is:

$$V = (L/2) \cdot (A_1 + A_2) \quad (\text{Eq 10-1})$$

Cross-sectional areas are measured in square feet, and the resultant volume is converted to cubic yards by dividing the measure area by 27 cubic feet/cubic yard (cf/cy).

$$V = (L/54) \cdot (A_1 + A_2) \quad (\text{Eq 10-2})$$

where A1 and A2 are expressed in square feet.

In cases in which even 100-ft cross sections are run, the above formula simplifies to

$$V = (1.852) \cdot (A_1 + A_2) \quad (\text{Eq 10-3})$$

The results of Equations 10-1 through 10-3 are exact only when the end areas are exactly equal (i.e., $A_1 = A_2$). As one end area approaches zero, the trapezoidal element becomes a pyramid, and the error in using the average-end-area volume formula approaches 50%. This commonly occurs in dredging projects where large area variations are found between successive cross-sections, especially along the toes and slopes.

b. Prismoïdal corrections to AEA. Various types of prismoïdal correction formulas have been developed over the centuries to compensate for the inherent inaccuracy in the AEA formulas above. Most prismoïdal corrections are based on the so-called "Simons Rule" for approximate numerical integration.

$$V = (L/6) \cdot (A_1 + 4 \cdot A_m + A_2) \quad (\text{Eq 10-4})$$

where A_m is the area of a mid point cross section run between sections A_1 and A_2 .

These prismoïdal corrections were once widely used in earthwork and dredging quantity computations, perhaps to imply a sense of mathematical precision to widely varying survey data (i.e., varying end areas). They are no longer applied in practice for dredging estimates. A higher accuracy was often achieved by decreasing the cross-sectional spacing in attempts to define the terrain more precisely (e.g., cross-sectional end areas become more nearly equal). This increased field survey densification increased costs, which may not be proportionate to the increase in accuracy of the computed volumes. (This highlights the obvious advantage of full-coverage multibeam systems over single beam cross sections in computing pay estimates. Multibeam systems effectively provide equivalent cross section spacing at dense intervals; roughly equal to their footprint or reduced cell size.)

10-22. Box Cut Allowance. Many districts provide an allowance for material left above the pay prism grade on side slopes when sufficient non-pay excavation has been performed at the base of the slope to allow for sloughing. Such box cut quantities must be computed separately due to limitations in payment, which shall not exceed the excessive excavated yardage at the base of the slope. This allowance is illustrated in Figure 10-13. Box cut payment allowances are not

uniformly applied throughout the USACE--e.g., payment for over-excavation inside or outside the channel toe. Automated computation of box cut allowances adds complexity to the quantity take-off process. Since traditional box cut computation methods were derived from manual cross-section planimeter techniques, automated terrain model analysis cannot be effectively performed; thus, AEA sections may need to be generated even though full terrain model data is available. Often box cut quantities are negligible relative to the overall volume. More significantly, AEA box cut quantity computations have been shown to have significant biases (up to 50%) due to zero allowances on many successive cross-sections. For these, and other reasons, use of a box cut allowance should be justified on a project-by-project basis.

- a. The following contract clause is typical of those used for box cut allowances:

“Side Slopes. Side slopes may be formed by box cutting or dredging along the side slope. Material actually removed, within the limits approved by the Contracting Officer, to provide for final side slopes not flatter than shown on the contract drawings, but not in excess of the amount originally lying above this limiting side slope, will be estimated and paid for in accordance with the provisions contained in paragraphs, "Measurement" and "Payment" above. Such amount will be estimated and paid for whether dredged in original position or by box cut dredging whereby a space is dredged below the allowable side slope plane on the bottom of the slope for upslope material capable of falling into the cut. [Specify any tolerance limits relative to channel toes]”

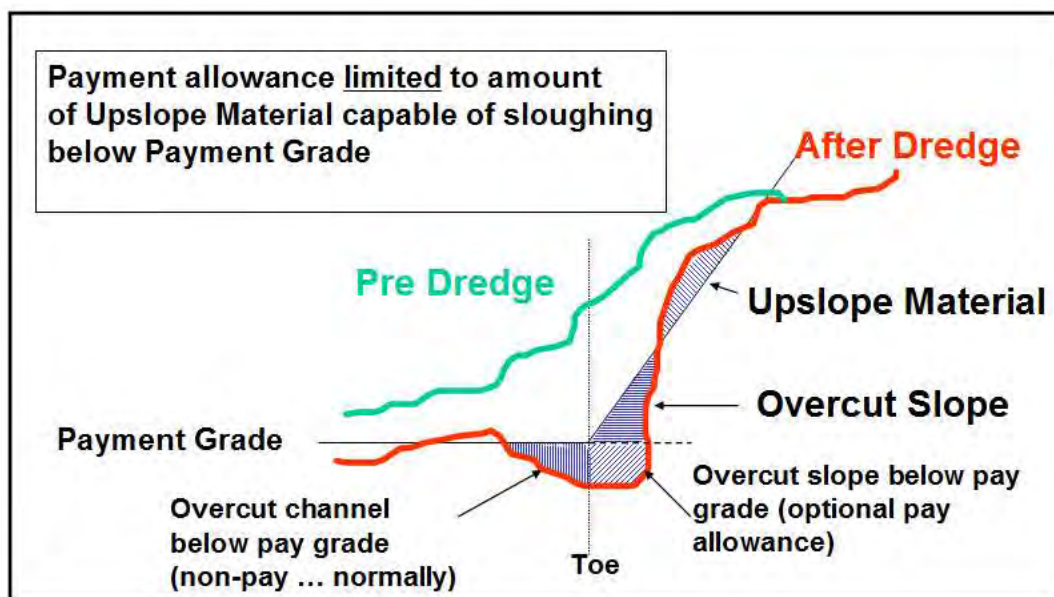

Figure 10-13. Box cut payment allowance is limited to amount of upslope material capable of sloughing below payment grade (see EP 1130-2-520). Pay extensions restrictions) are usually specified inside or outside the toe—typically 25 ft.

- b. There are two methods in the HYPACK CSV software that handle Box Cut allowances. Both of them only consider the void underneath the allowable overdepth template. In the "AEA3 Method," only material in the allowable overdepth side slope can fall into a void beneath the allowable overdepth template, inward from the toe a user specified distance. In the Jacksonville District "PostDredge Method," material on the side slope that is above the design template and in the allowable overdepth template can be considered available for credit. The void can be computed outward from the toe, and inward from the toe.

10-23. Cross-Section End Area and Volume Computations. Over the years, USACE districts have used a number of methods to compute the area of a cross-section that is used in the AEA volume

computation. Some of the more prevalent methods of computing cross-sectional areas for dredging are listed below. Details on most of these methods can be obtained in any engineering or surveying handbook.

a. Direct formula methods. Prior to automated data collection and computers, various formulas were used for computing end areas directly from cross-section notes in field books. These computations were performed on simple calculators using the grade and template coordinates. Generally, data along each section was sparse (i.e., tag line surveys) so these coordinate computations were not too difficult to manually perform. The most commonly used calculation was the "double meridian distance" (DMD) method. The cut (or fill) section is treated as a closed traverse, and the area is computed using the offsets (departures) and the depths (latitudes). Offset and depth at the slope-grade intersect (slope stake point) must be interpolated or scaled on the cross-section plot since these values are not directly measured in the field. Likewise, a depth must be scaled at each channel toe. A simple cross-multiplication system was used for computing the (double) area of the section.

(1) A simplified example of this manual DMD computation is shown in Figure 10-14. In this example, pre- and post-dredge end areas are computed separately and relative to the (-) 40.0-ft payment prism. These end areas are combined for use in the AEA volume computation with adjacent cross-sectional areas. Alternatively, the payment end area (4,225 sq ft) could have been directly computed. It was usually desirable to compute available pay quantities as soon as the pre-dredge survey was completed (to compare with the bid quantity estimates); thus, the (usually) small amount of material remaining on the after-dredge survey is easily computed and deducted from the pre-dredge quantity.

(2) As computers evolved in the 1960s, cross-sections coordinates were input and coordinate end area computations (and quantities) performed on a mainframe computer. The coordinate data was typically input from punch cards, also a labor-intensive process.

(3) As the density of points along a given cross section increases, this manual computation process can become time-consuming. It would be prohibitive given current data collection where hundreds of points are obtained along a cross-section. However, dense

automated cross-section data could be pasted into a spreadsheet and the quantity computation performed using the DMD method. Such a process might be used to check that end areas computed in automated software are performing "exact" results.

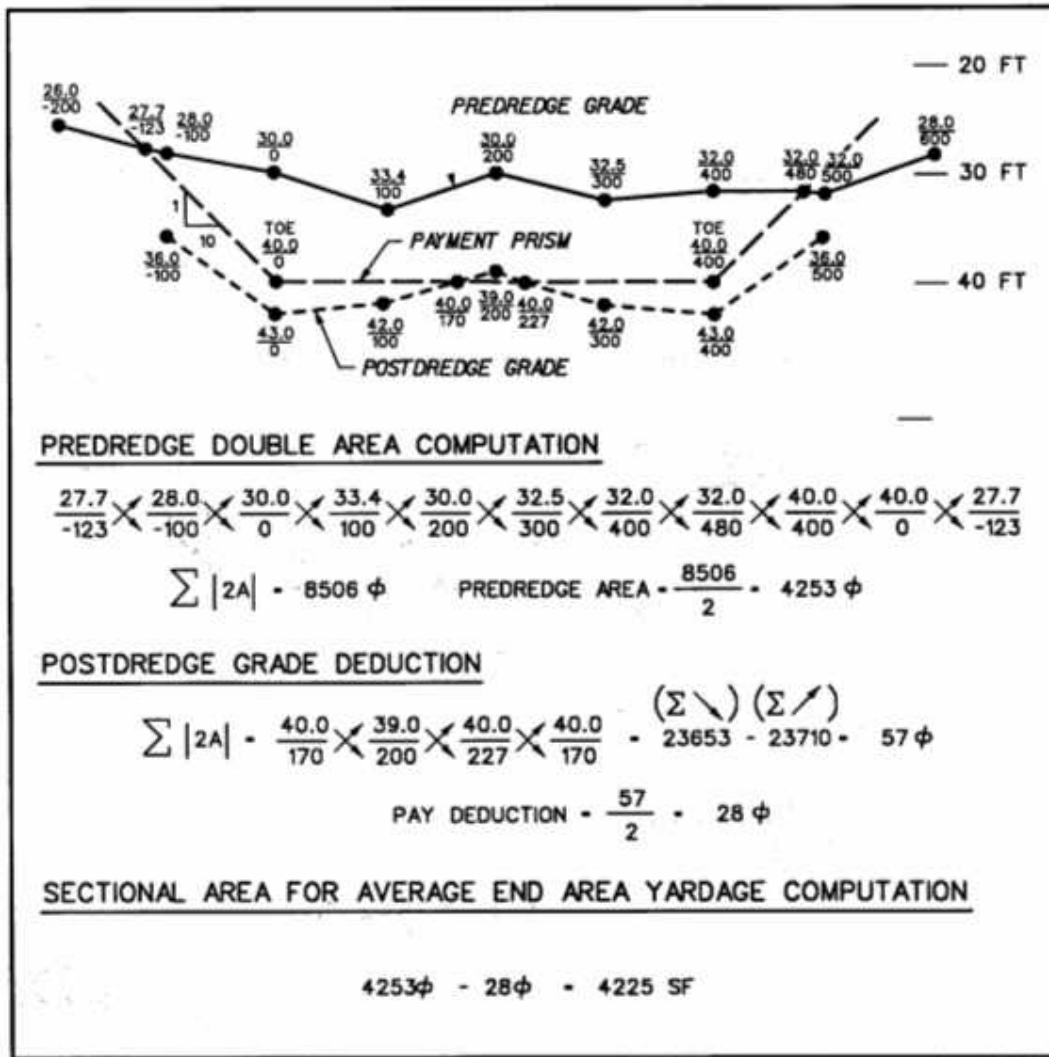

Figure 10-14. Typical predredge and postdredge quantity take-off by coordinate method.

b. Planimeter end areas. A polar planimeter (Figure 10-15) is a mechanical device that can directly measure areas on a drawing. It was once commonly used by many districts to measure end areas directly from the plotted section drawings. Although not as precise as a direct coordinate computation, it is typically accurate to about 1 or 2% of the computed end area. Normally, the end area was measured two or three times and the average taken as the final end

area. The disadvantage is that large-scale sectional plots of the survey data and payment templates are required for each cross-section. Section drawings were retained with bid, pre-dredge, and post-dredge cross-sections plotted, and the resultant pay area in the cross-section in Figure 10-14 would be measured. Non-pay areas were eliminated during this process. Box cut sloughing areas were separately measured with the planimeter.

c. Digitizing tablets. In the 1970s, mainframe and mini-computers with digitizing tablets were used to automate plotted sections and raw survey data, in effect, establishing coordinates for the data for subsequent automated end area computations. Older analog echo sounder paper records were digitized on these tablets—see Figure 10-15. This eliminated the need to plot large scale section drawings for each cross-section. The digitized data, along with the channel template, could then be used to compute end areas using coordinate or numerical integration methods, and subsequently volumes.



Figure 10-15. Quantity take-offs from polar planimeters (on left) and a digitizing tablet. The echo sounder analog record is directly digitized. (ca 1976 Jacksonville District)

d. Automated methods (numerical integration). As computer automation evolved in the 1970s, end areas (and quantities) could be directly computed from digitized and/or field-automated hydrographic survey data. This process is essentially unchanged to this date. The end area on a cross-section may be computed by a number of methods, such as coordinate/DMD areas, summing trapezoidal elements, or numerical integration. The first two methods require interpolation routines to determine toes and slope stake points, but the third method (numerical integration) does not. Numerical integration simply breaks up the cross-section at a fixed interval (e.g., 0.1 or 1 foot) and interpolates depths within this interval; summing up the small area increments across the channel to obtain the total sectional area. Most CADD software systems use some form of this method to compute end areas. In addition, upslope box cut payment allowances can be simply and directly computed using numerical integration methods.

10-24. HYPACK Average End Area Dredge Volume Computations. The basic option in the HYPACK “Cross Sections and Volumes--CSV” routine computes volumes using the “traditional” average end formula shown above. The CSV routine first subdivides the channel template into segments: LL = Left side slope, LC = Center channel (or LCL = Left of Center Channel and LCR = Right of Center Channel), and LR = Right side slope. The area of each of these segments on a cross section is computed by an exact polygonal end area formula. Average end area

EM 1110-2-1003

30 Nov 13

volumes are then computed for each channel segment by multiplying the average end area of each segment by the projected distance between each segment.

a. Standard HYPACK. The “Standard HYPACK” optional average end area calculation in CSV is slightly different from the above basic AEA method in that each segment is subdivided into 100 slices. Standard HYPACK then interpolates a depth for each corner of the slice, computes the volume of each slice, and sums all the slices to determine the volume for the segment (Figure 10-16). This computational method more closely resembles the TIN prismatic method of volume calculation. Computing prismatic volume elements with the Standard HYPACK method is more accurate than the traditional (basic) AEA methods, especially when there are significant differences in end areas between successive sections, or when the material is located on the inside or outside regions between non-parallel cross-sections.

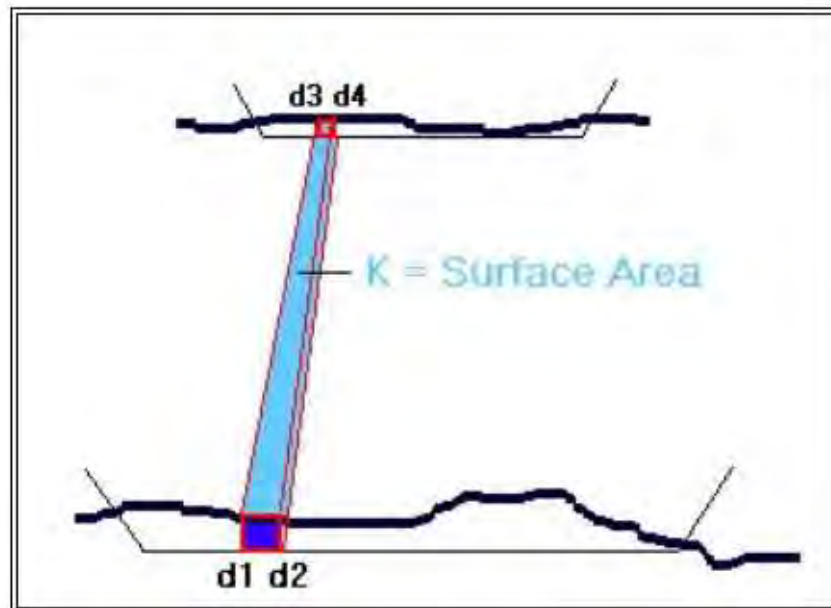

Figure 10-16. Standard HYPACK prismatic end area and volume computation method.

b. Templates. For all end area computations, channel prism templates must be defined for each cross-section. For most navigation channels these templates are regular, defined by the channel depth, the two toes, and side slopes—i.e., 3 segments. Template variations occur in channel widenings, turning basins, depth grade changes, or channel width changes. Grade changes may occur across the channel template, necessitating additional segments (HYPACK can

accommodate up to 20 segment changes in a cross section). As channel prisms and grade change segments get more complex, TIN Model surface differencing volume computation routines are preferable to average end area methods.

(1) HYPACK's CSV module has options tailored to these varied payment templates; providing methods to determine both Non-Contour and Contour Dredging payment computations, side slope payment options, box cut allowances, complex channel segments, and both average end area and surface-to-surface methods. This is illustrated in the cross-section shown in Figure 10-17. This example contains both the project grade (design grade) and overdepth grade (subgrade) areas/volumes. It also adds a third template--termed a "supergrade"--that could be an advance maintenance grade limit or used for estimating quantities at different grades. Figure 10-17 also shows some of the segmented subdivisions used to cover the various payment methods used in the USACE. These subdivided areas in the cross-section allow for separating Non-Contour and Contour methods, side slope payment variations, box cut allowances, non-pay material, shoaling, etc. These options have application to project managers and design engineers studying and evaluating shoaling rates and locations, or non-pay dredging. The cross section end area subdivision codes used in Figure 10-17 are listed in Figure 10-18.

(2) As an example of how the end area zones are used to accommodate the differing payment methods, the V2 sector represents all material in the overdepth zone (between the toes); all of which would be paid under the Non-Contour Method but only a portion of which is paid under the Contour Method. That portion is defined by the sectors V2P (Pay) and V2NP (Non-pay). The Contour Method would provide payment for the V2P sector, but the V2NP sector would not be paid since there was no material lying above the required depth. Contour Dredging Method volume computations require comparisons between the pre- and post-dredge surveys since payment is restricted to areas where material lies above the required grade on the pre-dredge survey. If material in the sector V2NP is excavated during dredging, it is not paid. The Contour Method presumes a degree of dredging accuracy that may not be achievable--especially in hopper dredging. Its intent is to avoid paying for substantial quantities of material lying below the required grade but above the overdepth grade. This material is paid in the Non-Contour Method unless physical dredging limits ("Borders") are placed in areas where material lies below the required grade but above the overdepth grade.

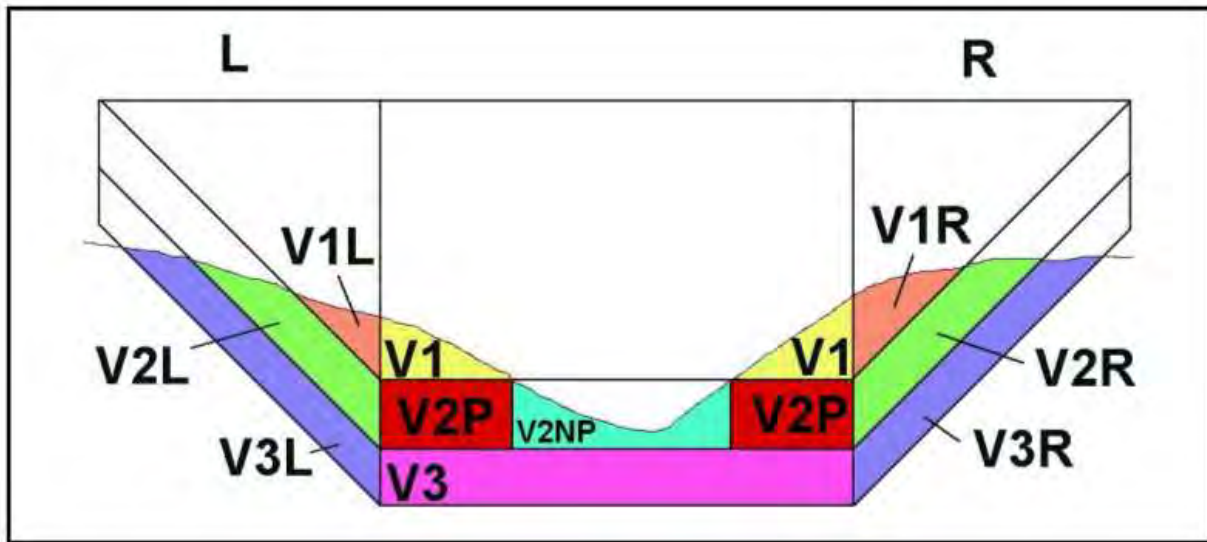

Figure 10-17. Segmented channel cross-section depicting pay and non-pay areas. (HYPACK, Inc.)

- V1: The volume of material above the design surface in the center of the channel.
- V1L: The volume of material above the design surface of the left bank.
- V1R: The volume of material above the design surface of the right bank.
- V2: The volume of material between the design and the overdepth grade surfaces in the channel center.
- V2P: The volume of material between the design and the overdepth grade surfaces in the channel center where the depth is less than the design surface.
- V2NP: The volume of material between the design and the overdepth grade surfaces in the channel center where the depth is greater than the design surface.
- V2L: The volume of material between the design and the overdepth grade surfaces of the left bank.
- V2R: The volume of material between the design and the overdepth grade surfaces of the right bank.
- V3: The volume of material between the overdepth grade and the supergrade surfaces in the channel center where the depth is less than the design surface.
- V3L: The volume of material between the overdepth grade and the supergrade surfaces of the left bank.
- V3R: The volume of material between the overdepth grade and the supergrade surfaces of the right bank.
- X2: The amount of material removed beneath the design surface by a box cut inside the channel toes. Enter the distance used to consider box cuts. (Not shown in Figure 10-17)
- X1: The amount of material on the left or right banks that is above the design surface. X1 can be credited to fall into an X2 hole. (Not shown in Figure 10-17)
- Y1: The amount of material which has been deposited during the dredging process. (Infill) (Not shown)
- DELTA Predredge –Postdredge of each V value [Computed]
- TOYPAY Delta + Y1: The quantity of material removed, ignoring areas where the Postdredge profile is above the Predredge profile. [Computed]

Figure 10-18. Sectional end area subdivisions used by HYPACK.

c. USACE Average End Area calculation methods. Figure 10-19 is a list of some of the volume computations options in HYPACK that are tailored to individual USACE districts.

Method	Single Survey	Average End Area Method	Target Number of Template Points	# of Templates
AEA 1	Yes	Yes	4	3
AEA 2	Yes	Yes	4	3
AEA 3	Pre vs. Post	Yes	4	3
Standard HYPACK	Yes	No	Up to 20	2
Savannah	Yes	Yes	4	2
Philadelphia PreDredge	Yes	Yes	5	2
Philadelphia PostDredge	Pre vs. Post	Yes	5	2
Jacksonville PreDredge	Yes	Yes	4	3
Jacksonville PostDredge	Pre vs. Post	Yes	4	3
Norfolk	Yes	Yes	4	4
GLDD 1	Yes	Yes	4	3
GLDD 3	Pre vs. Post	Yes	4	3
Kingfisher	Yes	Yes	4	3
AEA No Segments	Yes	Yes	N/A	2
Beach Pre-Dredge 'New'	Yes	Yes	Up to 20	3
Beach Post-Dredge 'New'	Pre vs. Post	Yes	Up to 20	3
Zone Listing PreDredge	Yes	Yes	N/A	2
Zone Listing PostDredge	Pre vs. Post	Yes	N/A	2
End Area No Template	Pre vs. Post	Yes	No Template is Used	N/A

Figure 10-19. HYPACK Average End Area computation methods and options.

d. Example Average End Area computation. The following sample computation in Figure 10-20 is performed over a 1,188 ft dredging acceptance section. The channel limits are irregular as shown by varying offsets for each cross-section—this dredging section encompasses a channel widener. The final yardage values represent the material available on the pre-dredge survey. A similar take off would be made on the after-dredge survey and any remaining material from that survey would be subtracted from the pre-dredge results. The HYPACK Software Manual (HYPACK 2011) contains sample outputs of other USACE dredge quantity computations

EM 1110-2-1003

30 Nov 13

Office Engineering Section, Survey Branch, Jacksonville District
 Pre-Dredge Survey (No. 98-C041) Cont. No. DACW17-98-C-0004
 Date of Survey: 24 February 1998

		Project	Over	Left	Right
Station to Station		Depth	Depth	Slope	Slope
61+00 72+88		34.0	36.0	3.0/1	3.0/1

Dredging Quantities Summary

```

=====
Total Material to Project Depth ..... 11309.4 CY
Total Allowable Overdepth ..... 11853.4 CY
Total Pay Place ..... 23162.8 CY
  
```

Dredging Quantities Computation

```

=====
----- Reference Depth = 34.0 ft -----
Station      Left      Left      Right      Right      Volume
             Slope    Channel  Channel    Slope      (CY)
             -----
61+00        0.0       0.3       0.0        0.0         0
  Offset:    -302     -200     +200     +302
62+00       11.6      99.2      50.3        5.9       309.8
  Offset:    -302     -200     +200     +302
63+00       24.5     172.3     33.5         5.6       746.2
  Offset:    -302     -200     +200     +302
64+00       24.4     204.4     26.6         4.6       918.7
  Offset:    -302     -200     +200     +302
65+00       33.5     191.5         0.5         0.1       900.2
  Offset:    -302     -200     +210     +317
66+00       29.3     188.5       7.9         1.5       837.9
  Offset:    -302     -200     +239     +346
67+00       27.5     194.2     24.7        12.0       931.3
  Offset:    -303     -200     +262     +367
68+00       37.8     261.4     10.3         2.1      1093.6
  Offset:    -303     -201     +290     +394
69+00       38.2     277.7         0.0         0.0      1210.2
  Offset:    -305     -201     +314     +418
70+00       33.9     239.1         5.4         1.1      1143.2
  Offset:    -306     -203     +341     +444
71+00       29.2     214.7     53.5         5.7      1095.9
  Offset:    -309     -204     +369     +469
72+00       22.8     201.6     84.4        13.5      1145.0
  Offset:    -312     -206     +395     +497
72+88       10.0     176.8     96.9        14.3       977.4
  Offset:    -315     -208     +419     +521
----- Overdepth = 2 ft -----
             Left      Left      Right      Right      Volume
             Slope    Channel  Channel    Slope      (CY)
             -----
61+00        2.0       4.0       0.0         0.0         0
62+00       20.0     134.0     98.0        12.0       500.1
63+00       26.0     144.0     98.0        14.0      1011.2
64+00       26.0     158.0     72.0        12.0      1018.6
65+00       28.0     166.0         8.0         2.0       876.2
66+00       26.0     170.0     34.0         6.0       812.9
67+00       30.0     174.0     50.0        22.0       969.3
68+00       34.0     202.0     32.0         8.0      1045.7
69+00       34.0     200.0         0.0         0.0       978.6
70+00       32.0     200.0     24.0         6.0       946.2
71+00       30.0     190.0     132.0        12.0      1150.8
72+00       24.0     202.0     142.0        20.0      1349.4
72+88       16.0     218.0     124.0        18.0      1194.5
  
```

Figure 10-20. Typical average end area computation output for a predredge survey.

10-25. Average End Area Computations on Irregular Channels or Non-Parallel Sections.

Average End Area computation methods from single-beam surveys become complex when channel sections have varying limits, at channel intersections with widener sections present, in irregularly shaped turning basins, when survey cross-sections are not run perpendicular to the channel alignment, and when cross-sections are not parallel. An example is shown in Figure 10-21. When cross sections are not run normal, or perpendicular, to the project centerline, the section's projected intercept with the side slope must be adjusted in section plots or automated software when computing end areas. This commonly occurs in turning basins and widener sections. The plotted side slope is corrected as a function of the angle of intercept. Average-end-area projections are made relative to the actual survey spacing interval, not to the project alignment stationing. In areas where different sectional alignments merge, irregularly shaped triangular or trapezoidal surface areas result, often resulting in overlapping (duplicate) volumes or voids where material was actually removed. Various methods are employed to proportionately distribute end areas over these irregular areas, both during field surveys (HYPACK "Smart Corners") or in volume computation software.

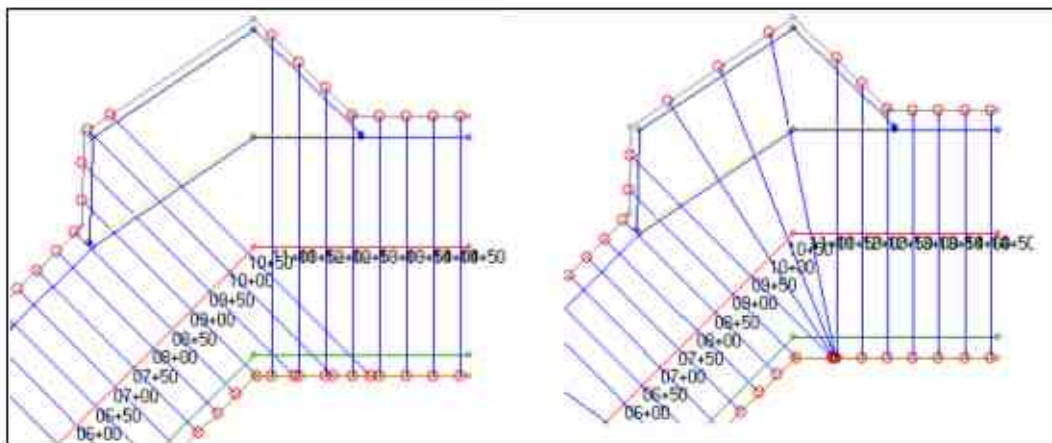

Figure 10-21. Problems with average end area volumes in irregular channels and non-normal cross-section alignments. The large void on the left is improved by adding additional cross-sections ("Smart Corners") as shown on the right.

a. On the left side of Figure 10-21, volumes for each of the overlapping and void areas must be estimated. These cross sections hit the slopes at differing angles, requiring adjustments to the projected areas. Projecting the end areas on the void at the outside of the channel turn is a guess, at best. Deducting end areas at the intersecting section is likewise a rough estimate.

b. The solution is to employ the 'Smart Corners' option in HYPACK's CHANNEL DESIGN program when creating the field survey line files--running additional sections as shown on the right side of Figure 10-21. Volume computation programs will generate more accurate

EM 1110-2-1003

30 Nov 13

volume quantities when this survey coverage option is selected, as long as accurate projection distances between the sections are applied. To better eliminate the small voids at the two turning basin corners, “bisector” sections should have been run through the points.

c. The above example clearly illustrates the difficulty in using average end area techniques (and single beam surveys) for irregular shapes or non-normal sections. Quantity estimates in such areas are truly "estimates," and are often educated guesses. For this reason, surfacing differencing TIN volume computation techniques should be employed even if only cross section data is available. The irregular channel template surface (nodes and slopes—i.e., "channel framework") can be input as a 3D terrain model, as shown in Figure 10-22. The channel template surface model is then not dependent on the survey coverage or alignment method. The volume is simply computed between the two surfaces.

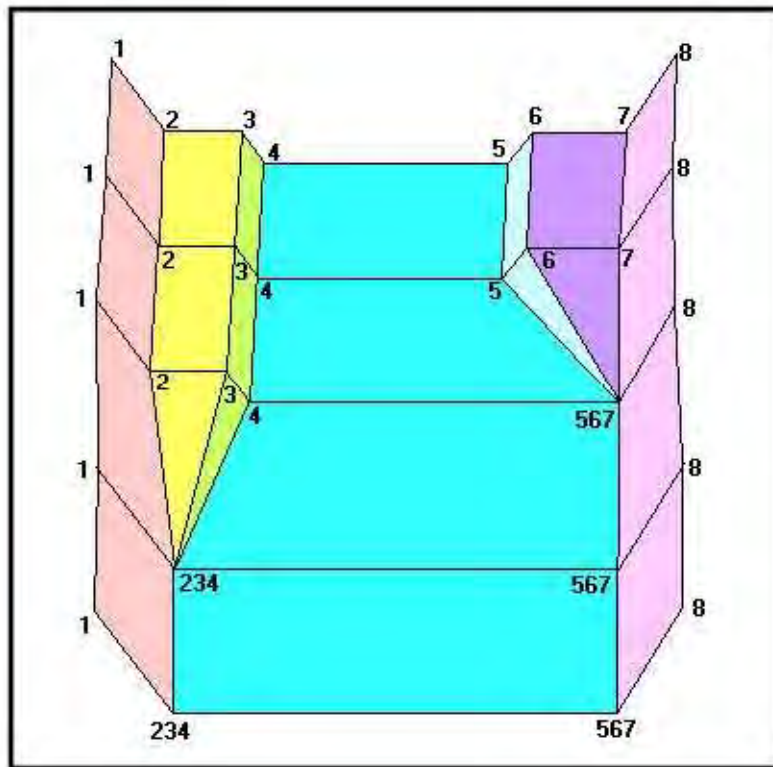

Figure 10-22. Channel template models (HYPACK Advanced Channel Design)

d. Curved channel sections. Some USACE navigation projects are defined relative to a circular alignment and cross-sections are taken normal to that alignment. These sections may be

in the navigation or flood control project or up the overbank levees. In the case of curved alignments with cross sections run perpendicular to the alignment, average end areas are projected about the radius of the centroid for each section in order to compute the volume. Various mechanical and numerical methods exist for computing the centroids of irregular areas (see Figure 10-23).

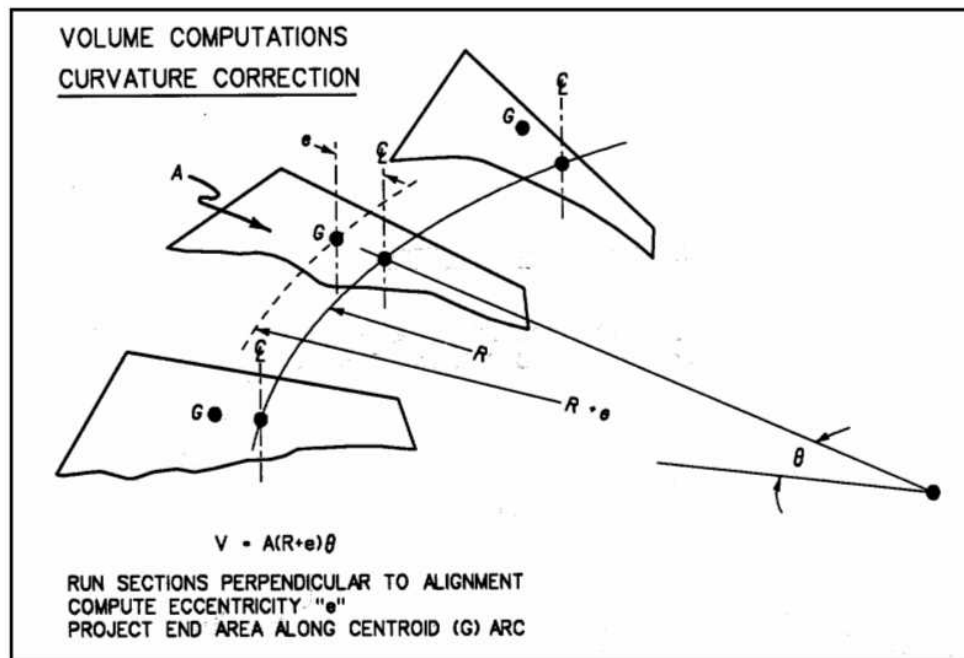

Figure 10-23. Curved channel volume computations.

e. Obtaining complete coverage for quantity computations. A major survey deficiency exists when complete coverage is not obtained over the entire payment area. This often occurs when survey vessels are unable to perform pre-dredge surveys into shallow waters where excavation is subsequently performed. In other cases, the slope-grade intersect point may be above the surface, requiring land topographic survey coverage at the junction area. In either case, volume computations are incomplete without full coverage through the slope-grade intersect points. This is the case regardless of the computation method (AEA or TIN). The distance ("t") that coverage is required outside the toe of a channel may be estimated by the following:

$$t = \text{Slope} \cdot (\text{Required depth} - \text{Upslope depth}) \quad (\text{Eq 10-5})$$

where:

t = slope-grade intersect distance from toe

Slope = design slope ratio (H/V)

Required depth = project design or overdepth

Upslope depth = average minimum depth atop slope/bank

For example, given a 40-ft project with typical 20 ft natural grades up a 3 on 1 side slope, the required coverage outside the channel toes would be 60 ft ($t = 3 \cdot (40-20)$). A distance of 100 ft would likely be specified to allow for topographic irregularities and vessel maneuvering. It is essential that coverages be verified prior to computing quantities using automated software. Most programs have no alarm to indicate inadequate coverage. Verifying coverage is done by viewing 3-D models or section views of the project to ensure coverage.

SECTION IV

Surface Differing Volume Computations (Triangulated Irregular Networks)

This section describes surface differencing (TIN) methods used for estimating dredged quantities. As with AEA techniques, there are a variety of computational methods used throughout the USACE. Likewise, numerous software platforms are used, such as MicroStation, AutoCAD, and HYPACK. This section primarily illustrates the techniques in the HYPACK "TIN Model Program" since it is designed directly for dredging projects.

10-26. Background. The Triangulated Irregular Network (TIN) volume computation technique is based on a comparison of two terrain models. In the case of dredged material volumes, one model represents the actual bottom terrain as surveyed (Figure 10-24), and the other model usually represents a design surface (e.g., required depth and overdepth), although two surveyed surfaces can also be compared. TIN routines offer great flexibility in the collection of survey data, since the terrain coordinates need not be in any particular pattern or alignment. TIN programs also enable visual terrain models of the surveyed topography and of design, or hypothetical, terrain surfaces. As stated earlier, a TIN model volume is also more accurate than an AEA volume computed from the same database. TIN routines for volume determination and terrain visualization are commonly available in commercial site design and some survey software packages. For dredged material volume applications, TIN routines are particularly well suited to cases in which the channel is not a simple straight layout, such as in turning basins, settling basins, widener sections, curved channels, etc.

a. General concept of TINs. A TIN is actually a set of triangles that represent the terrain surface. Consider a set of survey coordinates marked on a map. These coordinates are "triangulated": a set of triangles is specified such that their vertices are these spatial points, no triangle contains coordinates other than its vertices, and the triangles cover the area of interest exactly and without overlapping each other. Any such set of triangles defines a TIN. The maximum area a TIN can cover is the "convex hull" of all coordinates. That convex hull is the polygon which contains all coordinates, whose vertices are the coordinates, and which is convex; that is, any straight line segment connecting two points in the interior of the polygon is entirely contained by the polygon. The convex hull of all coordinates is also the convex polygon of

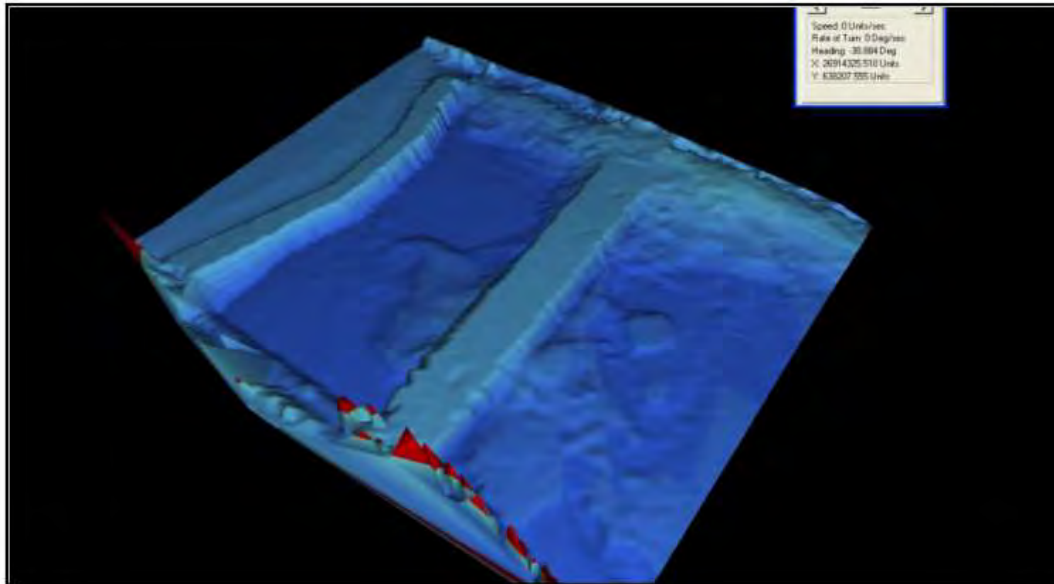

Figure 10-24. Color-coded three-dimensional TIN surface model of Poe Lock Debris Pit, St. Marys River, Detroit District.

the smallest area containing all coordinates. A TIN may fail to cover its maximum area while still covering all available coordinates; some triangles along the boundary may be missing.

b. Terrain and design surfaces. The salient feature of the TIN volume methods is that they construct two surfaces, a TIN "terrain surface" developed from depth (elevation) measurements and a "design surface" which represents the design specifications. Terrain information consists typically of a list of X-Y-Z coordinates, with the horizontal coordinates specified by X-Y and the spatial coordinate z recording the measured elevation. When a TIN is generated for the given measurement sites and the corresponding triangles and vertices are joined in space, a terrain surface results. The design surface consists of polygonal surfaces. A desired design surface (navigation channel), for instance, is sometimes specified as a long rectangle with adjacent polygons for side slopes. X-Y points on the channel are termed "nodes." Polygonal surfaces are represented by their constituent planar polygons or "facets" in space. For input purposes, they are mainly defined in terms of "design breaklines," the line segments at which facets are joined. Those breaklines terminate at "design breakpoints." Typically, three breaklines meet in a breakpoint.

c. Polygonal surfaces. TIN surfaces are also instances of polygonal surfaces. They represent the special case in which all polygonal facets are triangles. Polygonal surfaces are often represented, somewhat artificially, as a TIN surface if the polygonal facets are partitioned into triangles. In that case, breaklines are generic to all such surfaces. The design surfaces

EM 1110-2-1003

30 Nov 13

encountered in road construction, as well as in hydrographic applications, tend to be of a special form: their cross sections perpendicular to a centerline are similar to each other. Some commercial packages, therefore, offer an alternate surface specification method suited to surfaces of this particular kind. The idea is to "push a template," that is, to interpolate a design surface through a sequence of cross-sectional design delineations or "templates." This design specification method is ideal for long stretches of channels. However, if a channel changes direction, side slopes vary, or more complex designs such as turning basins are used, the template method characterizes the true design surface only approximately.

d. Cut volume. The space bounded by the terrain and design surfaces defines the volume to be determined. This space is subdivided into vertical triangular prisms, that is, polytopes with three vertical edges capped by two, not necessarily parallel, triangles, as shown back in Figure 10-11. The volume of such a prism is rendered exactly by the formula:

$$V = [(h_1 + h_2 + h_3) / 3] \cdot (A) \quad (\text{Eq 10-6})$$

where

h = height of vertices above design (pay) prism

A = triangular area of prismoidal element projected on design surface

Thus, the "h1," "h2," and "h3" heights represent the lengths of the three vertical edges of the prism, and "A" denotes the area of the triangle that arises as a vertical projection or footprint of the prisms onto a horizontal plane. Indeed, "A" is the area of the underlying TIN triangle. The volumes of all the prisms that constitute the cut body are then added to arrive at its total volume. The cut volume is therefore calculated on a triangle-by-triangle basis. This requires, however, that the dredged area (that is, the projection of the cut body onto the reference plane) be fully triangulated.

(1) Note that some TIN triangles of the dredging area may be clipped by the boundary of the dredge area so that their remainders within the dredge area are non-triangular polygons, typically quadrangles. A straightforward way of dealing with this situation is to subdivide these polygons into triangles. In this fashion, the volume of the cut body, as defined by the TIN terrain surface, is rendered exactly. There are, in general, several different ways to subdivide a non-triangular polygon into triangles. Since each of the polygons to be subdivided is part of a TIN triangle corresponding to a planar region on the terrain.

(2) As with the average-end-area computation, the user should be cautious of areas in which the design surface extends, in the X-Y plane, beyond the terrain surface. In such areas, there exists no terrain surface with which to compare for volume information. Similarly, no volumes can be obtained for areas in which the terrain model has no corresponding design surface. TIN routines usually assume vertical bounds at the edges of the terrain and design

surfaces. Therefore, volumes are only determined for those X-Y areas in which terrain and design information exists. Note that if vertical bounds are not created by the TIN routine, the

program may produce erroneous results in those areas of discrepancy. The user should check the TIN routine for proper handling of terrain/design surface gaps.

10-27. Computing Dredge Volumes from TIN Models. The "TIN Model Program" in HYPACK calculates the volumes between two different surfaces. Applicable USACE options include the following.

a. Survey Surface vs. Level. This option compares a TIN surface against a level plane. This would be applicable to disposal or borrow area surveys. It is also used to determine the volume and surface area of a 'pool' when performing reservoir calculations.

b. Survey Surface TIN vs. Channel. This is the most common dredging application--comparing a TIN surface against a defined channel framework prism. This option is a common application for USACE navigation projects, such as computing Bid, Predredge, and/or Postdredge quantities relative to the fixed channel template(s). This option is especially applicable in projects irregular boundaries, grades, and side slopes, as illustrated in Figure 10-25. There are multiple options in the TIN vs. Channel calculations, as outlined below.

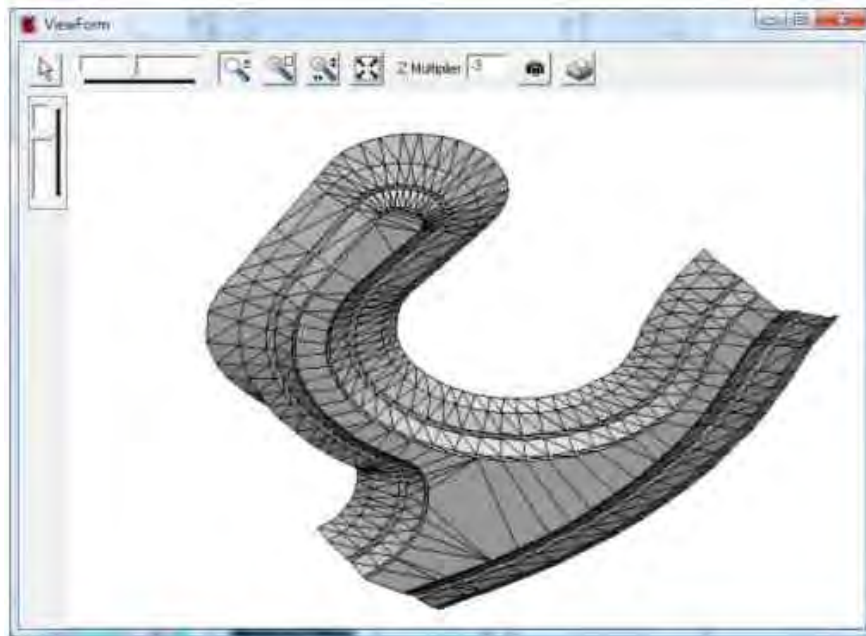

Figure 10-25. Design surface template. TIN volume computations are especially applicable when the framework template consists of curved channel alignments and varying pay grades and side slopes. (Curved channels are actually modeled by a series of straight segments.)

(1) Standard TIN-to-Channel. This option computes four values (Volume Above, Volume Below, Area Above, Area Below) for each face of the channel file specified, as well as their totals for the entire channel.

(2) TIN-to-Channel Zones. If defined reporting zones were created in ADVANCED CHANNEL DESIGN, the program can compute volumes for each reporting zone, subdivided between pairs of planned lines, instead of each face. Areas are not calculated.

(3) Border-limited TIN-to-Channel. Volume calculations can be limited to user-defined border areas in the channel.

(4) Survey Surface vs. Second Survey Surface (TIN to TIN). This option compares two TINs irrespective of any payment prism—e.g., pre- versus post-dredge survey volumes.

(5) Survey Surfaces vs. Design Surface. This option represents the volume between the Design Surface and the survey surfaces.

Dredging Quantities Summary			
=====			
Materials	Gross Material	Infill	Net Material
Total Pay Removed to Project Depth	7510.9	803.8	6707.1
Total Pay Removed in Overdepth	2749.7	112.4	2637.3
Total Pay Removed	10260.6	916.2	9344.4
Total Removed	12504.3	2533.6	9970.7
Total Remaining Above Project Depth	2519.8		2519.8
Total Overdredged Material	2243.7	1617.4	626.2
Total Infill Material		2533.6	

Total Pay Removed to Project Depth: Material removed above the channel design template.
 Total Pay Removed in Overdepth: Material removed between the channel design and overdepth templates.
 Total Pay Removed: The sum of the above two items.
 Total Removed: The Total Pay Removed plus the Total Overdredged Material.
 Total Remaining Above Design: Based on the After Dredge survey, the material that remains above the channel design template.
 Total Overdredged Material: The amount of material that was removed beneath the allowable overdepth template.
 Total Infill Material: Material where the After Dredge survey is shoaler than the Before Dredge survey.

Figure 10-26. Sample Philadelphia Method Summary Report—Predredge versus Postdredge Survey.

c. Philadelphia (District) Method. The Philadelphia District Method calculates pre-dredge and post-dredge volumes using surface-to-surface (TIN) methods and outputs the results in a format similar to station-by-station average end area reports. The advantage of this method is that accurate TIN volumes are computed but they are additionally output in an AEA format desired by project managers and engineers. In other words, the output resembles that generated from traditional AEA quantity computations. The "Philadelphia Predredge Method" computes

volumes relative to the design/pay grade template surface model. The "Philadelphia Postdredge Method" computes volumes between two surfaces—e.g., the Predredge and Postdredge surveys—and the payment templates. Both Non-Contour and Contour payment methods are supported. A

summary report (Figure 10-26) of the material volumes is also generated by the Philadelphia District Method.

d. A sample Philadelphia District Method volume computation is shown on the plates below. Additional details and examples on each of the above Philadelphia District methods, and options therein, are covered in the HYPACK User Manual (HYPACK 2011).

EM 1110-2-1003

30 Nov 13

Plate 9-1. Philadelphia District TIN Volume Computation Method. The following examples depict volume computations from full-coverage multibeam surveys using the Philadelphia District Method. The first section computes quantities between a pre-dredge multibeam survey and the channel required depth and overdepth templates. The second section computes final pay, non-pay, and infill (remaining) quantities between the pre-dredge and post-dredge surveys relative to the channel templates.

Project: Philadelphia to the Sea--Acceptance Sections 1 and 19 (2,945 ft channel length)

Pre-Dredge Survey: 1 Nov 12

Post-Dredge Survey: 27 Nov 12

Philadelphia to the Sea encompasses the navigation channel from the city of Philadelphia to the Lower Delaware Bay where it empties into the Atlantic between Cape Henlopen, De and Cape May, NJ. This particular project is deepening the channel from 40 ft to 45 ft in the river between Philadelphia, PA and Camden, NJ.

PRE-DREDGE VOLUMES [PRE-DREDGE SURVEY v CHANNEL FRAMEWORK TEMPLATE] PHILADELPHIA TIN V TIN SURFACE DIFFERENCING METHOD

File Version 12.0.0.23

TIN File: C:\HYPACK 2012\Projects\Philadelphia to the Sea\Sort\1Nov12_AS1,2,19,20_BD_MLLW_3x3avg.xyz

Section File: C:\HYPACK 2012\Projects\Philadelphia to the Sea\AS#1&19_Reach A.lnw

Mode: Depth

Aligned to LNW: No

Remove Narrow Triangle: No

Max Leg: 15.00

X Maximum: 315362.19 X Minimum: 312770.68 Y Maximum: 391083.42 Y Minimum: 385650.22 Z Maximum: 56.72 Z Minimum: 14.69

Number of Points: 520866 Number of Triangles: 1041730 Volume unit: Cubic Yard

Philadelphia Pre-Dredge Report Volume Totals

TIN File: C:\HYPACK 2012\Projects\Philadelphia to the Sea\Sort\1Nov12_AS1,2,19,20_BD_MLLW_3x3avg.xyz

Section File: C:\HYPACK 2012\Projects\Philadelphia to the Sea\AS#1&19_Reach A.lnw

Dredge File: C:\HYPACK 2012\Projects\Philadelphia to the Sea\Sort\1Nov12_AS1,2,19,20_BD_MLLW_3x3avg.xyz

Line File: C:\HYPACK 2012\Projects\Philadelphia to the Sea\AS#1&19_Reach A.lnw

Method: Side Slope

Dredge Option: Non Contour

Plate 9-1 (continued).

Section to Section	Project Depth	Over Depth	Left Slope	Right Slope
32+755 to 35+700	45.00	46.00	3.0/1.0	3.0/1.0

PRE-DREDGE VOLUME ESTIMATES AT 100-FT STATIONS

Pre Dredge report Section Name	Volume above Design -----				Volume in Overdepth -----			
	Left Slope	Left Channel	Right Channel	Right Slope	Left Slope	Left Channel	Right Channel	Right Slope
32+755 to 32+800	0.0	0.0	899.2	28.7	0.0	0.0	273.6	14.6
32+800 to 32+900	0.0	0.0	2011.3	57.6	0.0	0.0	743.6	42.0
32+900 to 33+000	0.0	0.0	1383.5	60.5	0.0	0.0	746.1	42.9
33+000 to 33+100	0.0	0.0	919.5	87.5	0.0	0.0	672.2	50.9
33+100 to 33+200	0.0	0.0	816.6	107.3	0.0	0.0	590.2	56.2
33+200 to 33+300	0.0	0.0	943.5	151.9	0.0	0.0	451.1	67.0
33+300 to 33+400	0.0	0.0	1554.3	166.0	0.0	0.0	545.4	67.4
33+400 to 33+500	0.0	0.0	1962.2	176.4	0.0	0.0	763.7	70.8
33+500 to 33+600	0.0	0.0	2275.7	194.8	0.0	0.0	767.5	75.7
33+600 to 33+700	0.0	0.0	2272.1	201.3	0.0	0.0	771.0	77.8
33+700 to 33+800	0.0	0.0	2181.3	218.5	0.0	0.0	774.4	80.6
33+800 to 33+900	0.0	0.0	1969.9	213.6	0.0	0.0	777.8	78.7
33+900 to 34+000	0.0	0.0	1780.0	172.2	0.0	0.0	781.2	70.3
34+000 to 34+100	0.0	0.0	1134.0	170.3	0.0	0.0	775.4	70.7
34+100 to 34+200	0.0	0.0	1573.9	171.8	0.0	0.0	774.8	70.5
34+200 to 34+300	0.0	0.0	1782.4	130.7	0.0	0.0	766.2	62.0
34+300 to 34+400	0.0	0.0	1774.4	145.8	0.0	0.0	776.2	63.3
34+400 to 34+500	0.0	0.0	1517.1	115.1	0.0	0.0	782.1	58.6
34+500 to 34+600	0.0	0.0	1175.3	86.4	0.0	0.0	702.3	50.3
34+600 to 34+700	0.0	0.0	857.4	26.3	0.0	0.0	636.5	28.5
34+700 to 34+800	0.0	0.0	662.0	24.3	0.0	0.0	550.1	29.5
34+800 to 34+900	0.0	0.0	553.1	30.2	0.0	0.0	523.6	33.4
34+900 to 35+000	0.0	0.0	363.4	40.4	0.0	0.0	512.3	36.5
35+000 to 35+100	0.0	0.0	292.7	40.3	0.0	0.0	563.6	36.8

EM 1110-2-1003

30 Nov 13

Plate 9-1 (continued).

35+100 to 35+200	0.0	0.0	227.3	27.9	0.0	0.0	693.6	32.2
35+200 to 35+300	0.0	0.0	416.5	8.2	0.0	0.0	769.1	19.7
35+300 to 35+400	0.0	0.0	310.4	3.7	0.0	0.0	727.9	15.8
35+400 to 35+500	0.0	0.0	423.9	2.0	0.0	0.0	745.2	12.5
35+500 to 35+600	0.0	0.0	832.2	17.1	0.0	0.0	715.8	25.8
35+600 to 35+700	0.0	0.0	1257.8	39.0	0.0	0.0	692.6	34.1

Total:	0.0	0.0	36122.9	2915.7	0.0	0.0	20365.0	1475.2

Dredging Quantities Summary

Total Material To Project Depth	39038.6
Total Allowable Overdepth	21840.2
Total Pay Place	60878.7

PRE-DREDGE V POST DREDGE VOLUME COMPUTATIONS
PHILADELPHIA TIN V TIN SURFACE DIFFERENCING METHOD

File Version 12.0.0.23

TIN File: X:_DATA_ARCHIVES__HYDRO_DATA_2012\PHILADELPHIA_TO_THE_SEA\Contract_Dredging\Reach A Deepening (12-C-0034)\Befores\AS#1 1 Nov 12 (32+755 to 35+700)\XYZ\1 Nov 12_AS#1_BD_MLLW_3X3_AVG.xyz

Additional File: E:\AS 1_2_3_19_20_21_37_27 NOV 2012\Edit (mllw)\27Nov12_AS1&19_AD_MLLW_3x3avg.xyz

Section File: C:\HYPACK 2012\Projects\Philadelphia to the Sea\AS#1&19_Reach A.lnw

Mode: Depth Aligned to LNW: No Remove Narrow Triangle: No Max Leg: 15.00

X Maximum: 315061.95 X Minimum: 313573.27 Y Maximum: 391089.95 Y Minimum: 388113.93 Z Maximum: 51.71 Z Minimum: 30.84

Number of Points: 294045 Number of Triangles: 588084

Volume unit: Cubic Yard

Philadelphia Post-Dredge (Tin to Tin) Volume Totals

TIN File: X:_DATA_ARCHIVES__HYDRO_DATA_2012\PHILADELPHIA_TO_THE_SEA\Contract_Dredging\Reach A Deepening (12-C-0034)\Befores\AS#1 1 Nov 12 (32+755 to 35+700)\XYZ\1 Nov 12_AS#1_BD_MLLW_3X3_AVG.xyz

Section File: C:\HYPACK 2012\Projects\Philadelphia to the Sea\AS#1&19_Reach A.lnw

Dredge File: X:_DATA_ARCHIVES__HYDRO_DATA_2012\PHILADELPHIA_TO_THE_SEA\Contract_Dredging\Reach A Deepening (12-C-0034)\Befores\AS#1 1 Nov 12 (32+755 to 35+700)\XYZ\1 Nov 12_AS#1_BD_MLLW_3X3_AVG.xyz

Plate 9-1 (continued).

Post-Dredge File: E:\AS 1_2_3_19_20_21_37_27 NOV 2012\Edit (mllw)\27Nov12_AS1&19_AD_MLLW_3x3avg.xyz
 Line File: C:\HYPACK 2012\Projects\Philadelphia to the Sea\AS#1&19_Reach A.lnw
 Method: Side Slope
 Dredge Option: Non Contour

Section to Section	Project Depth	Over Depth	Left Slope	Right Slope
32+755 to 35+700	45.00	46.00	3.0/1.0	3.0/1.0

DREDGING QUANTITIES SUMMARY

Materials	Gross Material	Infill	Net Material
Total Pay Removed to Project Depth	37605.2	14.8	37590.4
Total Pay Removed in Overdepth	20456.0	90.4	20365.6
Total Pay Removed	58061.2	105.2	57955.9
Total Removed	88415.1	6137.7	82277.5
Total Remaining Above Project Depth	41.5		41.5
Total Overdredged Material	30354.0	6032.4	24321.6
Total Infill Material		6137.7	

PRE-DREDGE V POST-DREDGE VOLUMES AT 100-FT SECTIONS

Section	Volume Removed Above Channel Design				Volume Removed in Overdepth Region				Volume Removed Beneath Overdepth Template			
	Left Channel	Left Channel	Right Box	Right Box	Left Channel	Left Channel	Right Box	Right Box	Left Channel	Left Channel	Right Box	Right Box
32+755 to 32+800	0.0	0.0	885.4	27.8	0.0	0.0	271.7	14.3	0.0	0.0	148.3	57.2
32+800 to 32+900	0.0	0.0	1949.6	55.9	0.0	0.0	737.9	41.5	0.0	0.0	342.8	165.2
32+900 to 33+000	0.0	0.0	1335.5	58.4	0.0	0.0	745.8	42.2	0.0	0.0	835.5	168.6
33+000 to 33+100	0.0	0.0	887.2	85.9	0.0	0.0	640.8	50.3	0.0	0.0	959.3	217.2
33+100 to 33+200	0.0	0.0	794.6	104.8	0.0	0.0	563.8	55.5	0.0	0.0	872.2	217.0
33+200 to 33+300	0.0	0.0	920.5	148.4	0.0	0.0	442.2	66.3	0.0	0.0	697.8	218.2
33+300 to 33+400	0.0	0.0	1519.3	163.7	0.0	0.0	528.7	66.9	0.0	0.0	1400.9	236.5

EM 1110-2-1003

30 Nov 13

Plate 9-1 (continued).

33+400 to 33+500	0.0	0.0	1907.0	173.7	0.0	0.0	762.2	70.0	0.0	0.0	1305.4	231.9
33+500 to 33+600	0.0	0.0	2225.1	191.6	0.0	0.0	767.5	75.2	0.0	0.0	1083.8	223.7
33+600 to 33+700	0.0	0.0	2220.2	197.2	0.0	0.0	771.0	77.5	0.0	0.0	1101.5	306.0
33+700 to 33+800	0.0	0.0	2129.9	215.0	0.0	0.0	768.7	78.3	0.0	0.0	1180.9	144.8
33+800 to 33+900	0.0	0.0	1916.3	209.8	0.0	0.0	760.9	75.6	0.0	0.0	1095.8	101.9
33+900 to 34+000	0.0	0.0	1724.1	169.4	0.0	0.0	777.0	68.4	0.0	0.0	1234.7	166.2
34+000 to 34+100	0.0	0.0	1082.0	166.8	0.0	0.0	753.2	66.1	0.0	0.0	1219.5	156.4
34+100 to 34+200	0.0	0.0	1528.2	167.0	0.0	0.0	737.9	61.2	0.0	0.0	1025.2	129.0
34+200 to 34+300	0.0	0.0	1738.9	125.8	0.0	0.0	693.4	41.7	0.0	0.0	470.3	31.5
34+300 to 34+400	0.0	0.0	1710.3	138.3	0.0	0.0	566.9	36.3	0.0	0.0	330.0	20.5
34+400 to 34+500	0.0	0.0	1441.2	110.2	0.0	0.0	619.7	43.3	0.0	0.0	425.1	31.2
34+500 to 34+600	0.0	0.0	1128.7	83.8	0.0	0.0	669.3	48.0	0.0	0.0	775.7	144.1
34+600 to 34+700	0.0	0.0	808.0	25.2	0.0	0.0	619.8	27.9	0.0	0.0	1025.4	206.6
34+700 to 34+800	0.0	0.0	624.9	23.2	0.0	0.0	536.3	28.8	0.0	0.0	826.7	279.0
34+800 to 34+900	0.0	0.0	520.7	28.6	0.0	0.0	494.6	32.6	0.0	0.0	577.5	231.6
34+900 to 35+000	0.0	0.0	336.8	37.8	0.0	0.0	475.8	35.3	0.0	0.0	399.0	196.3
35+000 to 35+100	0.0	0.0	276.1	37.7	0.0	0.0	440.3	35.8	0.0	0.0	374.0	228.4
35+100 to 35+200	0.0	0.0	207.6	26.0	0.0	0.0	588.7	31.1	0.0	0.0	557.9	203.5
35+200 to 35+300	0.0	0.0	355.2	7.3	0.0	0.0	707.4	18.7	0.0	0.0	1102.6	164.7
35+300 to 35+400	0.0	0.0	259.9	3.0	0.0	0.0	650.1	14.8	0.0	0.0	1116.3	164.2
35+400 to 35+500	0.0	0.0	367.1	1.6	0.0	0.0	691.2	11.7	0.0	0.0	1009.8	165.2
35+500 to 35+600	0.0	0.0	772.4	16.1	0.0	0.0	628.4	25.2	0.0	0.0	750.2	245.7
35+600 to 35+700	0.0	0.0	1195.4	36.9	0.0	0.0	670.8	33.5	0.0	0.0	873.0	184.5
<hr/>												
Total:	0.0	0.0	34768.2	2837.0	0.0	0.0	19081.9	1374.1	0.0	0.0	25117.2	5236.8

Plate 9-1 (continued). INFILL QUANTITIES (ACCRETED OR MISPLACED MATERIAL)

Section	Infill Above Channel Design				Infill in Overdepth Region				Infill Beneath Overdepth Template			
	Left Box	Left Channel	Right Channel	Right Box	Left Box	Left Channel	Right Channel	Right Box	Left Box	Left Channel	Right Channel	Right Box
32+755 to 32+800	0.0	0.0	0.0	0.0	0.0	0.0	0.0	0.0	0.0	0.0	0.0	23.1
32+800 to 32+900	0.0	0.0	0.0	0.0	0.0	0.0	0.0	0.0	0.0	0.0	0.0	73.5
32+900 to 33+000	0.0	0.0	0.0	0.0	0.0	0.0	0.0	0.0	0.0	0.0	0.0	85.6
33+000 to 33+100	0.0	0.0	0.1	0.0	0.0	0.0	0.1	0.0	0.0	0.0	0.0	117.9
33+100 to 33+200	0.0	0.0	0.0	0.0	0.0	0.0	0.2	0.0	0.0	0.0	0.0	133.6
33+200 to 33+300	0.0	0.0	0.0	0.0	0.0	0.0	0.0	0.0	0.0	0.0	62.5	148.5
33+300 to 33+400	0.0	0.0	0.0	0.0	0.0	0.0	0.0	0.0	0.0	0.0	0.2	181.5
33+400 to 33+500	0.0	0.0	0.0	0.0	0.0	0.0	0.0	0.3	0.0	0.0	0.0	203.1
33+500 to 33+600	0.0	0.0	0.0	0.0	0.0	0.0	0.0	0.0	0.0	0.0	0.0	155.7
33+600 to 33+700	0.0	0.0	0.0	0.0	0.0	0.0	0.0	0.0	0.0	0.0	0.0	92.6
33+700 to 33+800	0.0	0.0	0.0	0.0	0.0	0.0	0.0	0.3	0.0	0.0	0.0	129.1
33+800 to 33+900	0.0	0.0	0.0	0.0	0.0	0.0	0.0	0.0	0.0	0.0	0.0	189.3
33+900 to 34+000	0.0	0.0	0.0	0.0	0.0	0.0	0.0	0.0	0.0	0.0	0.0	212.9
34+000 to 34+100	0.0	0.0	0.0	0.0	0.0	0.0	0.0	1.9	0.0	0.0	0.0	220.6
34+100 to 34+200	0.0	0.0	0.1	0.4	0.0	0.0	1.6	2.8	0.0	0.0	0.0	276.4
34+200 to 34+300	0.0	0.0	0.0	1.7	0.0	0.0	0.1	4.4	0.0	0.0	0.0	284.4
34+300 to 34+400	0.0	0.0	0.7	2.5	0.0	0.0	1.0	5.6	0.0	0.0	0.0	335.3
34+400 to 34+500	0.0	0.0	5.1	0.7	0.0	0.0	3.5	2.9	0.0	0.0	0.0	288.7
34+500 to 34+600	0.0	0.0	0.0	0.0	0.0	0.0	0.3	0.3	0.0	0.0	0.4	232.5
34+600 to 34+700	0.0	0.0	0.0	0.0	0.0	0.0	1.2	0.0	0.0	0.0	0.9	379.4
34+700 to 34+800	0.0	0.0	0.0	0.0	0.0	0.0	0.0	0.0	0.0	0.0	14.8	241.0
34+800 to 34+900	0.0	0.0	0.0	0.0	0.0	0.0	0.1	0.0	0.0	0.0	22.1	216.9
34+900 to 35+000	0.0	0.0	0.0	0.0	0.0	0.0	0.1	0.0	0.0	0.0	26.9	254.2
35+000 to 35+100	0.0	0.0	0.0	0.0	0.0	0.0	4.6	0.0	0.0	0.0	11.2	202.2
35+100 to 35+200	0.0	0.0	0.0	0.0	0.0	0.0	13.1	0.0	0.0	0.0	1.0	244.7
35+200 to 35+300	0.0	0.0	0.0	0.0	0.0	0.0	7.0	0.0	0.0	0.0	0.0	305.8
35+300 to 35+400	0.0	0.0	0.0	0.0	0.0	0.0	16.5	0.0	0.0	0.0	0.0	208.3
35+400 to 35+500	0.0	0.0	0.6	0.0	0.0	0.0	11.7	0.0	0.0	0.0	4.4	110.8
35+500 to 35+600	0.0	0.0	2.9	0.0	0.0	0.0	9.2	0.0	0.0	0.0	6.2	120.5
35+600 to 35+700	0.0	0.0	0.0	0.0	0.0	0.0	1.5	0.0	0.0	0.0	13.3	200.6
Total:	0.0	0.0	9.5	5.3	0.0	0.0	71.9	18.5	0.0	0.0	163.8	5868.6

EM 1110-2-1003

30 Nov 13

Plate 9-1 (concluded). MATERIAL REMAINING ABOVE REQUIRED GRADE AND IN OVERDEPTH REGION

Section	Remaining Above Channel Design				Remaining in Overdepth Region			
	Left Slope	Left Channel	Right Channel	Right Slope	Left Slope	Left Channel	Right Channel	Right Slope
32+755 to 32+800	0.0	0.0	0.0	0.0	0.0	0.0	1.6	0.0
32+800 to 32+900	0.0	0.0	0.0	0.0	0.0	0.0	5.7	0.0
32+900 to 33+000	0.0	0.0	0.0	0.0	0.0	0.0	0.0	0.0
33+000 to 33+100	0.0	0.0	0.1	0.0	0.0	0.0	15.9	0.0
33+100 to 33+200	0.0	0.0	0.0	0.0	0.0	0.0	1.5	0.0
33+200 to 33+300	0.0	0.0	0.0	0.0	0.0	0.0	0.8	0.0
33+300 to 33+400	0.0	0.0	0.0	0.0	0.0	0.0	0.0	0.0
33+400 to 33+500	0.0	0.0	0.0	0.0	0.0	0.0	0.0	0.6
33+500 to 33+600	0.0	0.0	0.0	0.0	0.0	0.0	0.0	0.0
33+600 to 33+700	0.0	0.0	0.0	0.0	0.0	0.0	0.0	0.0
33+700 to 33+800	0.0	0.0	0.0	0.0	0.0	0.0	5.7	2.4
33+800 to 33+900	0.0	0.0	0.0	0.0	0.0	0.0	16.9	2.7
33+900 to 34+000	0.0	0.0	0.0	0.0	0.0	0.0	4.2	1.3
34+000 to 34+100	0.0	0.0	0.0	0.0	0.0	0.0	14.9	5.5
34+100 to 34+200	0.0	0.0	0.1	1.6	0.0	0.0	32.7	11.7
34+200 to 34+300	0.0	0.0	0.0	4.1	0.0	0.0	68.7	24.1
34+300 to 34+400	0.0	0.0	6.9	7.4	0.0	0.0	205.8	32.1
34+400 to 34+500	0.0	0.0	15.1	2.0	0.0	0.0	160.6	17.4
34+500 to 34+600	0.0	0.0	0.0	0.0	0.0	0.0	25.9	1.7
34+600 to 34+700	0.0	0.0	0.0	0.0	0.0	0.0	7.0	0.0
34+700 to 34+800	0.0	0.0	0.0	0.0	0.0	0.0	0.8	0.0
34+800 to 34+900	0.0	0.0	0.0	0.0	0.0	0.0	8.8	0.0
34+900 to 35+000	0.0	0.0	0.0	0.0	0.0	0.0	9.6	0.0
35+000 to 35+100	0.0	0.0	0.0	0.0	0.0	0.0	86.8	0.1
35+100 to 35+200	0.0	0.0	0.0	0.0	0.0	0.0	78.1	0.0
35+200 to 35+300	0.0	0.0	0.0	0.0	0.0	0.0	57.9	0.0
35+300 to 35+400	0.0	0.0	0.0	0.0	0.0	0.0	72.9	0.0
35+400 to 35+500	0.0	0.0	0.6	0.0	0.0	0.0	55.3	0.0
35+500 to 35+600	0.0	0.0	3.5	0.0	0.0	0.0	89.5	0.0
35+600 to 35+700	0.0	0.0	0.0	0.0	0.0	0.0	18.8	0.0
Total:	0.0	0.0	26.3	15.2	0.0	0.0	1046.4	99.5

10-28. Overdepth Dredging Statistics (HYPACK "DREDGESTATS"). This program option calculates the statistics to show how many final depths in a data set are above and below a user-specified depth within a given area. The program accepts one or two data sets and compares them against the user-defined project depth. Data is only compared in the main channel; the depths on the side slopes and outside the main channel are ignored. A use of the program is to statistically evaluate the amount of dredging below the required grade, in the overdepth prism, and non-pay material below the overdepth pay grade. (Figure 10-27.) This program was developed in support of ERDC/CHL. For further details on overdepth dredging issues refer to ERDC/TN EEDP-04-37, Overdepth Dredging and Characterization Depth Recommendations, listed in Appendix A.

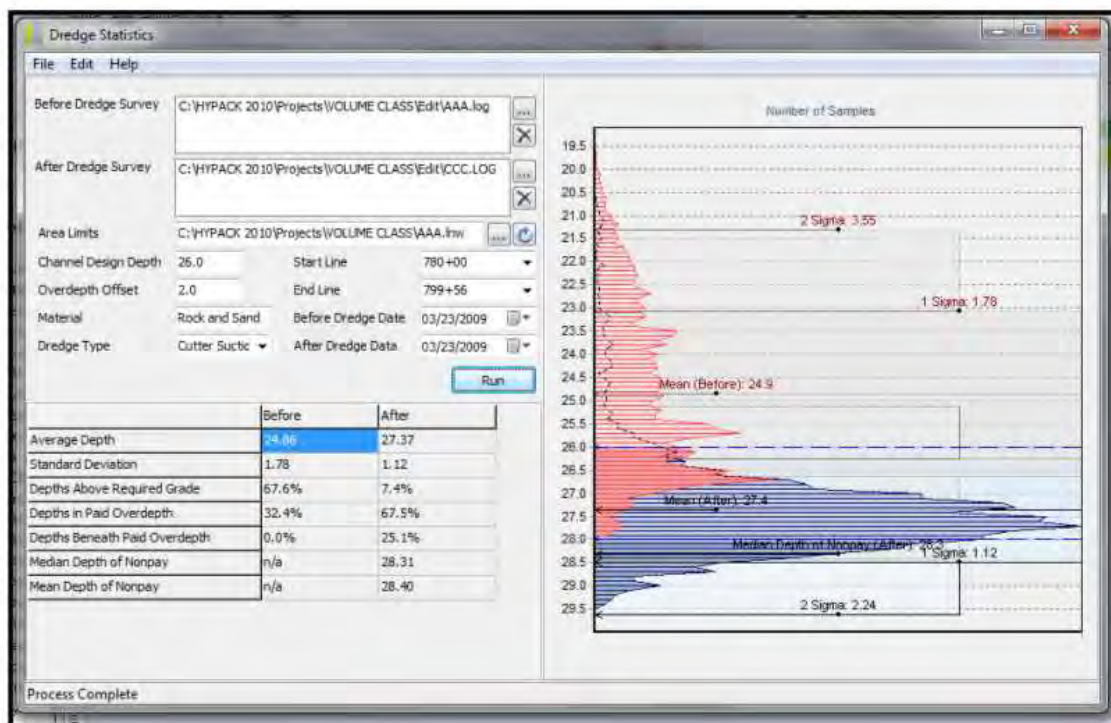

Figure 10-27. DREDGESTATS Dredge Statistic screen display. Statistics are given for depths within overdepth pay region (26 to 28 ft) and depths greater than 28 ft (non-pay over-dredging).

10-29. Evaluation of Dredge Quantity Estimates Based on Depth Accuracy and Density. Three primary factors affect the accuracy of dredge volume computations, in this order:

- (1) Terrain irregularity and data density
- (2) Bias errors in depth measurements
- (3) Deviation of depth observations

EM 1110-2-1003

30 Nov 13

Data density typically has the most important effect on the overall accuracy of a quantity computation. Required data density is a function of the irregularities in the terrain, as is clearly illustrated in Figure 10-28. Systematic biases in the depth database will obviously cause constant dredge volume errors. The deviation or estimated accuracy of the depths can cause volume errors if the standard deviation is large and an insufficient number of points are observed. A volume derived from a densely gridded/binned multibeam survey will usually yield a more accurate quantity than that obtained from 100-ft spaced cross-sections, even if the depth accuracy (i.e., standard deviation) of the multibeam survey is not as good as the cross-section depths. These concepts are discussed below.

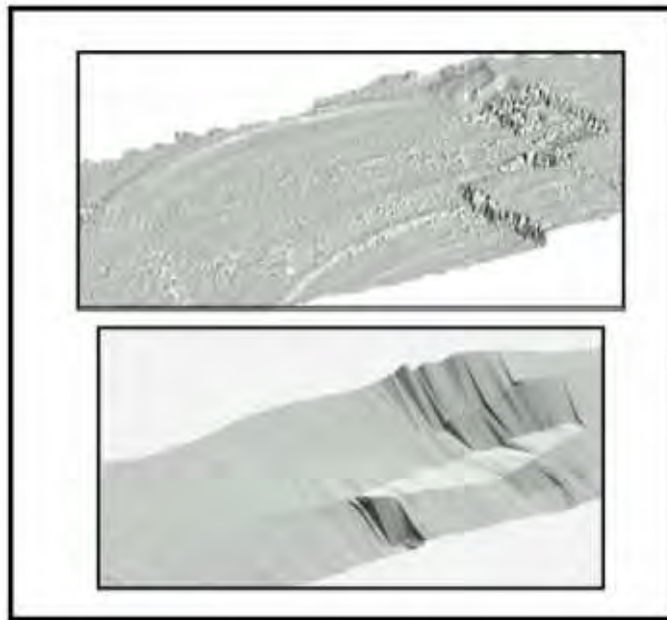

Figure 10-28. Single beam versus multibeam coverage -Port of Los Angeles. Drawings compare low density single beam coverage (bottom view) with detailed multibeam coverage (top view). Dredged sections are generalized in the single beam coverage. (HYPACK, Inc. and Los Angeles District)

a. Terrain irregularity impacts on volume accuracy. The effects of terrain irregularities on dredge volume computations depend on the density of data coverage. When end areas are computed for single beam cross-sections, large variations in the end areas would indicate terrain irregularity exists between the sections. Even if the cross-section data points were absolutely error free (no bias or standard deviation) volume errors due to terrain irregularity would still exist due to lack of measurements between the 100-ft sections. These effects can be illustrated by the following single-beam survey example.

Given: Typical 400-ft wide box-cut channel (no side slope quantities computed).
 Predredge shoaling fairly uniform at around 10 ft above pay grade.
 100-ft cross-sections run over 3,000 ft Acceptance Section.
 Average-end-area volume computation.

Station	Cross-sectional End Area
60+00	3850 sq ft
61+00	4125
62+00	3975
63+00	4225
64+00	4150
.	.
.	.
.	.
89+00	4125
90+00	3950

(1) In looking at the variations in end areas for the cross-sections, it is determined that their average deviation is approximately ± 100 sq ft. If depth measurement biases and deviations are assumed to be zero, then this end-area variance between cross-sections in a uniform shoal area is likely due to irregularities in the terrain and random survey errors. Had cross-sections been observed at 1-ft intervals (e.g., multibeam) then the end-area variations would be expected to be significantly less. The volume error over due to this ± 100 sq ft end area deviation can be computed by comparing the quantities over the section for a 4,000 sq ft and 4,100 sq ft end area. The percentage quantity error is simply:

$$\% \text{ error in volume} = (100 \text{ sq ft} / 4,000 \text{ sq ft}) = 2.5 \%$$

This 2.5 % error equates to 370 cy per 100-ft section or about 11,000 cy over the entire acceptance section (which has a total yardage of nearly 450,000 cy).

(2) Had the bottom terrain been more uniform, then the computed end-area variations would be smaller. A variation of ± 20 sq ft would have represented only a 0.5 % error on this project. If the end-areas were linearly increasing or decreasing (sloping shoal), then this slope would be considered in looking at variations in end areas. On the other hand, had there only been an average of 4 feet of shoaling above grade, then the relative volume error would be larger--i.e., $(100 \text{ sq ft} / 1,600 \text{ sq ft}) \cdot 100\% = 6.25\%$.

(3) Minimizing end-area volume errors due to terrain irregularities between single beam cross-sections is often impractical. Since the only way to minimize the error is to decrease line spacing, practical limitations prevent this. Decreasing line spacing to, say 20 ft, adds field survey time and cost. In addition, a 20-ft line spacing is near the tolerance of the ability to control the

EM 1110-2-1003

30 Nov 13

survey vessel on line. Since most average-end-area computations assume cross-sections are equally spaced--i.e., no off line steering deviations--projecting these lines over 20-ft distances is no longer valid. However, given the sparse cross-sections data sets, a TIN model may be generated for all the observed data points and volumes computed using the vertical TIN prismatic elements rather than average-end-area projections. This would represent a more accurate volume computation than average-end-area methods.

b. Impact of depth measurement bias errors on volume computations. A constant depth bias in the data set is estimated from single-beam cross-line checks or multibeam Performance Test data. The effect of a constant depth bias on a dredged quantity computation is obvious--the error projects over the entire dredging section (e.g., an Acceptance Section). Thus, minimizing any depth biases is critical. Using the 3,000 ft acceptance section in the above example, the quantity error due to a 0.1 ft depth bias can be approximately computed by projecting the bias over the entire section:

$$\text{volume error} = 0.1 \text{ ft} \cdot 400 \text{ ft} \cdot 3,000 \text{ ft} / (27 \text{ cy/ft}) = 4,450 \text{ cy}$$

$$\text{percent error} = 4,450 \text{ cy} / 450,000 \text{ cy} = 1 \%$$

In the above example, it is seen that the bias error (1%) is smaller than the error due to terrain variations (2.5%). This corresponds to theory and is roughly what occurs in practice. Bias error can become more significant in offshore tidal areas where modeling becomes difficult.

c. Impact of deviations in depth observations on volume computations. As an example, the standard deviation of depth measurements from Performance Tests on a navigation project is estimated to be ± 0.9 ft, or ± 1.8 ft at the 95% level. If there are no biases in the data, volumes computed over a given area from an infinite number of observed data points would have no error due to inaccuracies in individual depths. However, an infinite number of points are never observed. When single-beam cross-sections are taken, "full-coverage" is observed along the section if depths are recorded at intervals of 10-15 per sec. Normally, however, for both single-beam and multibeam surveys, data sets are generalized or "thinned"--i.e., binned or gridded. For example, single-beam cross-section data collected at 1-ft intervals may be generalized to points every 5- or 25-ft along the line, or dense multibeam data may be generalized into one data point in a 5- x 5-ft (25 sq ft) cell. This generalization is usually performed to reduce the size of the database. Either an average of all the points in a range or area is used or a single point nearest the cell center is used. The following over-simplified example illustrates how the data point accuracy and number of points can affect the dredge quantity computation.

Given: 100-ft single beam cross-section run over 26.0-ft lock chamber

OFFSET	DEPTH	Depth Used
0	26.1	26.1
5	26	
10	26	
15	26	
20	26.2	
25	26	26
30	25.9	
35	25.9	
40	26	
45	26.2	
50	25.9	25.9
55	26	
60	26	
65	25.8	
70	25.9	
75	26.3	26.3
80	26	
85	25.7	
90	26.1	
95	26	
100	26.2	26.2

(1) The mean of the 21 depths observed at 5-ft intervals is 26.0 ft and their 1- σ standard deviation is ± 0.14 ft. This indicates no bias in the data was observed in this dataset. The 95% confidence of the mean is ± 0.06 ft. Thus, if all the points were used to compute an end-area of this cross-section, the accuracy of the end area would be good.

(2) If depths were thinned to the even 25-ft intervals as shown in the above table, and only these depths used to compute the end-area of the cross-section, the end area accuracy would degrade significantly due to the few data points used. In this example, the mean of the five points is 26.1 ft, which, in effect adds a false 0.1 ft bias to the data. This 0.1 ft bias would be projected over the project area. The 95% confidence of this mean is also only (roughly) ± 0.14 ft., indicating little confidence in the measurements and ultimately the volume.

(3) The above illustrates that higher data density improves volume accuracy, either for average-end-area cross-sections or in binned matrix models. Larger numbers of data points minimizes the effects of random errors in the individual data points. Improperly thinning datasets will cause errors in the volumes. For example, to maintain a confidence level of ± 0.05 ft

EM 1110-2-1003

30 Nov 13

on a 30-ft project (estimated 95% depth accuracy is ± 1.0 ft), at least 400 points should be accurately collected. For a shallow-draft project, then only 100 data points would be needed to ensure ± 0.05 ft confidence.

d. Conclusions.

(1) Terrain irregularity has the major impact on the accuracy of volume computations. These effects are minimized by increasing data density and using spatial (TIN) volume computation methods. Average-end-area volume computation methods should only be used on projects with relatively uniform bottom terrain and where linearized end-area variations between successive sections are less than 0.5%. If end-area variations are large due to irregular bottom topography, then closer spaced cross-sections should be run or full-coverage multibeam surveys obtained.

(2) When sparse data sets (i.e., single beam cross-sections) are observed, TIN or dense grid volume computation methods using prismatic projection elements are more accurate than average-end-area methods. If full multibeam datasets are observed, volumes should not be computed by passing sparse cross-sections through the dataset and using average-end-area methods.

(3) Collected survey data used for volume computations should not be thinned in order to minimize volume errors due to data density and data point variance. If thinning is needed due to data processing limitations, it should be kept to a minimum. The degree of bottom irregularity will determine the amount of allowable thinning--i.e., maximum cell size. All observed depths on single beam surveys should be used in computing end-areas. For multibeam surveys, cell sizes should generally not exceed 5- x 5-ft bins. The smallest bin size that can be efficiently computed should always be used.

(4) Other factors that may impact dredge volumes. These may include errors due to fluff, vegetation, short-term draft or velocity variations, or sensitivity drift. These errors are difficult or impossible to quantify.

SECTION V

Recommended Guidance for Dredging Surveys and Quantity Computations

The following guidance is derived from best practices by USACE districts heavily involved in deep-draft dredging projects. These criteria were developed at numerous Multibeam User Group meetings held in the North Atlantic Division. Most USACE coastal districts were represented at these meetings or had input to this guidance. It is important to note that this guidance is recommended, not directive. Thus, there is no USACE policy requirement to follow these best practices.

10-30. Recommended Dredge Quantity Computation Procedures.

a. USACE payment templates. Both the Contour and Non-Contour payment templates may be used, depending on the dredging platform and purpose. The Non-Contour (Bordered) payment template is recommended for hopper dredging.

b. Side slope payment. In general, payment should be made for material lying above either the overdepth or required grade on the side slopes. Side slope payment may be optional on maintenance dredging in soft material. No payment might be made where there is minimal build up of shoal material along the toes, say less than 2 ft above required grade. If there is a major build up of material along the toe and extending into the side slope, then side slope payment would be warranted.

c. Box cut allowance. A box cut payment may optionally be measured and paid. Pay allowance should be made in non-pay areas lying any distance outside the channel toe and up to 25 feet inside the toe. Payment is not restricted to any depth below project grade. Payment cannot exceed the amount of above-grade material capable of sloughing into the cut areas. Continued use of the box cut allowance is discouraged due to excessive computational biases, computational complexities, disparities in software packages, disputes over payment techniques, and usually insignificant yardage allowances for box cuts on actual projects. If box cut allowances are computed from full-coverage sweep data contained in a TIN model, AEA cross-sections should be generated through the TIN model at a high density--say every 5 or 10 ft.

d. Volume computation method. Average end area (AEA) methods (Basic HYPACK) should be used for closely spaced cross-sectional data, and preferably only on straight, continuous, trapezoidal channels. The "Standard HYPACK AEA Method" is recommended for non-parallel cross-sections. Otherwise, surface differencing or TIN differencing methods are recommended. TIN methods should be used where cross-sections exceed 100 ft and/or where AEA cross-sections indicate large area variances between successive sections. TIN methods should also be used for mixed cross-section and cross-line data in order to utilize the full data set. Where full-bottom coverage is available from multibeam surveys, TIN volume techniques are recommended. TIN terrain model differencing is recommended for irregular basins or channels. The "Philadelphia District Method" is recommended for most TIN volume computations. Construction contract specifications should always detail the specific computation requirements.

e. Thinning and binning data sets. Thinning data sets is not recommended for dredge volume computations using single beam data. Data thinning is necessary when using data from multibeam surveys, since the full surface model contains millions of data points that may overload computer memory. If data thinning is necessary to reduce the size of the data set of a multibeam survey, users should utilize a binning program where the bin size is kept to a minimum and the average or median depths are used. If median depths are used, they should be

saved in their actual X-Y location and not moved to the center of the bin. Typical bin sizes used range from 1x1 ft to 5x5 ft.

EM 1110-2-1003

30 Nov 13

f. Volume computation software verification. Automated volume computation software shall be initially tested to ensure accurate, repeatable values are being computed. This may be done by comparison with a manual computation. An average end area computation may be checked by using data points from a single cross-section and computing the section end-area by the exact coordinate method described previously. At least 100 data points on the cross-section should be used. The manual and automated sectional end areas should agree to well within 0.1 sq ft. Box cut computational accuracy should similarly be tested and verified, using data from simulated pre and post dredging surveys. The survey data should have multiple intersect points with the template. TIN volume computations may be tested by comparing volumes computed from densely spaced AEA sections passed through the TIN model--e.g., 1-ft cross-sections cut through a 100-ft section of the model. Volumes should agree within one cubic yard. Automated software should be re-verified at each upgrade.

10-31. Contract Guide Specifications for Multibeam Measurement and Payment. The following contract clauses are recommended when multibeam systems are used on dredge payment or acceptance surveys. This version was developed by the North Atlantic Division Multibeam User's Group in 2004.

a. "HYDROGRAPHIC SURVEY EQUIPMENT. Hydrographic surveys will be conducted to meet USACE accuracy standards defined in EM 1110-2-1003, Hydrographic Surveying; specifically *[specify any standard deviation or repeatability tolerances]*. Surveys will be performed by single vertical beam transducer, or multiple vertical beam transducer sweep, or multibeam sweep methods. When vertical single beam or multiple sweep beam transducers are employed, an acoustic frequency of *[200 kHz (\pm 20%)] [or insert alternate frequency]* will be used. When utilizing multibeam technology, the operating acoustic frequency will range from [180 kHz to 250 kHz] *[or insert alternate frequency]*. All depth measurement devices, positioning, and motion compensation systems will be calibrated following the quality control procedures outlined in EM 1110-2-1003. Quality assurance Performance Tests to estimate data accuracy, repeatability, and maximum multibeam array limits [will] *[will not]* be performed."

b. "MEASUREMENT AND PAYMENT. The total amount of material removed and to be paid for under the contract, will be measured by the cubic yard in place. Measurement of the number of cubic yards in place will be made by computing the volume between the bottom surface shown by soundings of the last survey made before dredging and the bottom surface shown by the soundings of surveys made as soon as practicable after the work specified in each acceptance section has been completed. The volume for measurement will include the material within the limits described in the Paragraph entitled: "OVERDEPTH AND SIDE SLOPES', less any deductions that may be required for misplaced material described in the Paragraph entitled:

"DISPOSAL OF EXCAVATED MATERIAL" of this section. The volume of material removed will be generated by using either the Average End Area Method or by the TIN (Triangulated Irregular Network) computation, as outlined in the Hydrographic Surveying Manual EM 1110-2-1003, and subsequent changes/revisions issued by HQUSACE. All depths obtained from single beam surveys will be utilized for volume computation purposes. If multiple vertical transducer sweep systems or multibeam survey technology is used, a *[5-foot by 5-foot] matrix using the

*[average] [median] depth of all depths recorded in a cell will be generated from the edited multibeam data to perform the TIN volume computations, following the procedures outlined in EM 1110-2-1003. Any corresponding plotted plan view sounding sheets depicting representative depths over a dredging project will be generated using a cell size that is plot-scale dependent, utilizing a randomly selected sounding that is closest to cell center (shot depth) shifted to the center of the cell from the edited multi-beam data, as described in EM 1110-2-1003. If the material to be dredged in the contract is categorized to be hard bottom or rock, the matrix used for the volume computations will be reduced to a *[3 foot by 3-foot]* matrix and an *[average] [median]* of the soundings in the cell will be used. Shoal or strike plots depicting material above the required dredging grade will be generated using confirmed minimum depths in accordance with the data processing procedures outlined in EM 1110-2-1003. All raw survey data and edited/processed binned data used for volume computations shall be available to the Contractor upon request.”

EM 1110-2-1003
30 Nov 13

THIS PAGE INTENTIONALLY LEFT BLANK

CHAPTER 11

Coastal Engineering Surveys for Beach Renourishment Projects
and Shoreline Protection Structures

11-1. Introduction. This chapter provides guidance in performing coastal engineering surveys on USACE projects. Coastal engineering surveys are performed in support of sand transport studies, berm movement studies, beach renourishment placement measurement and payment, offshore borrow area dredging, jetty and breakwater construction, underwater investigation, and construction of shore and hurricane protection structures. An important component in this process is selecting the appropriate survey tools to collect data that meet project requirements and the needs of end users. Guidance in this chapter is intended to assist project planners and designers in reaching a common knowledge base for specifying effective survey data collection programs. This chapter also presents summary information on traditional, as well as newer, technologies for coastal surveying. Recommended accuracy standards and procedural methods are outlined for various coastal engineering projects.



Figure 11-1. Coastal surveys involve both topographic and hydrographic survey techniques. (Arc Surveying and Mapping, Inc.)

11-2. Required Supplemental Reference. Chapter 5, Procedures for Referencing Datums on Coastal Hurricane and Shore Protection Projects, of EM 1110-2-6056, Standards and Procedures

for Referencing Project Elevation Grades to Nationwide Vertical Datums, is incorporated by reference into this chapter. This reference describes the requirements for establishing primary control for all types of coastal engineering projects, to include Primary Project Control Points (PPCP) and Local Project Control Points (LPCP). It also describes how to establish firm geodetic connections and relationships between tidal, ellipsoidal, and geodetic (orthometric) datums. EM 1110-2-6056 supplements ER 1110-2-8160, Policies for Referencing Project Elevation Grades to Nationwide Vertical Datums, that requires project elevation grades shall be referenced to nationwide vertical datums established and maintained by the U.S. Department of Commerce.

11-3. General Procedures. A variety of topographic and hydrographic methods, equipment, and floating plant are used in performing coastal surveys. These technologies range from basic differential leveling methods to complex airborne platforms. Some methods directly measure topographic elevations through direct contact with the surface being surveyed, while others remotely measure water depth and must be corrected for water surface conditions such as waves and tides. Each method has its own inherent performance specifications, operational limitations, costs of operation, and special considerations. The type of technology selected to survey a project will largely depend upon a combination of requirements related to data end use accuracies, spatial data density, and survey budget. The selection of a particular system also depends on the project location, size, and environment. Coastal engineering studies typically do not need the high data density required for beach renourishment construction, jetty construction, or offshore breakwater construction. The following sections describe some of the techniques used for different types of coastal projects.

a. Beach surveys. Beach surveys combine land topographic cross-sections with offshore hydrographic sections—Figure 11-1. Beach profile lines (i.e., cross sections) are run perpendicular to the shoreline relative to the project baseline. Permanent benchmarks (PBM) are typically maintained along the entire project length. These benchmarks are set and published in the horizontal and vertical project datums. Temporary benchmarks (TBM) are used during beachfill operations or when total stations or levels are used for portions of the surveys. The fixed baseline is normally established well beyond (inland from) the dune line to ensure permanency for subsequent construction or periodic monitoring surveys. Permanent reference azimuths for each profile line are established relative to the fixed baseline. Profile elevations are obtained using boats, sleds, aircraft, hand-held rods, and other topographic measurement methods described in the remainder of this chapter.

(1) Profile spacing is highly project-dependent. For general coastal erosion or sand transport studies, profile lines may be spaced from 500 to 5,000 ft, depending on the regularity of the coast. Often funding availability drives the density of coverage for studies. Beach renourishment construction surveys for payment require denser spacing--typically at 100-ft intervals.

(2) Both topographic and hydrographic survey methods are employed to obtain continuous coverage of a beach profile line. As shown in Figure 11-2, topographic surveys are

run as far into the water as possible, usually at low tide. Single beam echo soundings are obtained at high tide to cover the surf zone and the offshore portions of the line. Topographic methods may only be needed for beach fill placement if material is placed out to wading depths. Coastal studies usually require depths out to a specified depth of closure; necessitating a hydrographic survey vessel to reach this point. The depth of closure is a depth where the ocean floor is generally stable and does not change with seasonal variation or storms.

(3) Although beach studies have traditionally been performed by running spaced profile lines, some districts (Los Angeles) have recently adopted full coverage surveys of the land and offshore areas. This can be accomplished by employing airborne LIDAR bathymetric and topographic techniques, along with multibeam full coverage surveys. This results in a complete topographic surface model of the study site rather than sparse cross-sections.

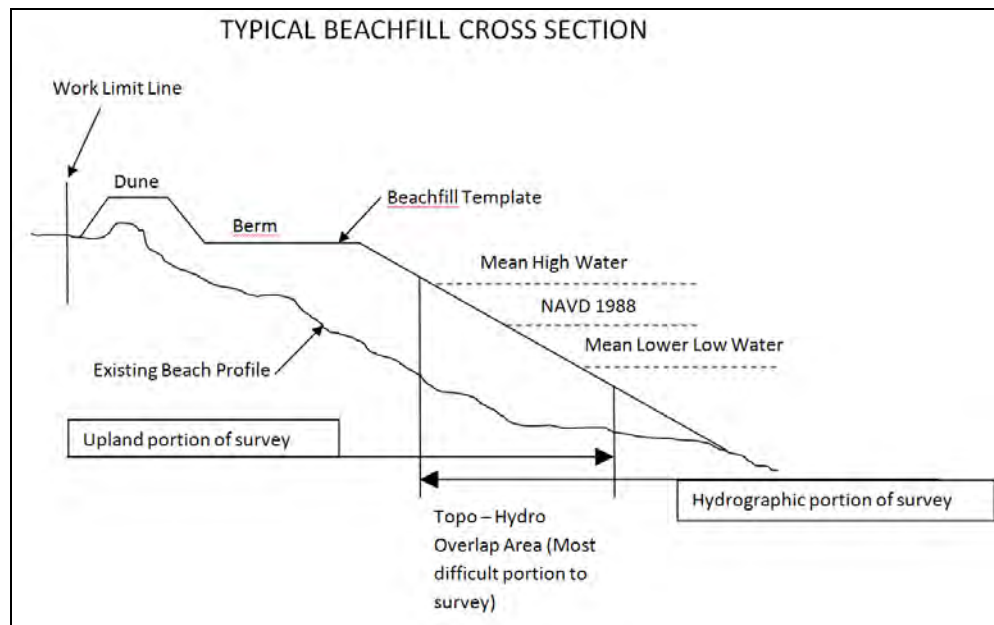

Figure 11-2. Topographic and hydrographic profile overlaps of typical beach renourishment sections.

b. Jetty, groin, and breakwater surveys. Construction and condition assessment surveys of shore protection structures requires far more detail than beach surveys described above. Although these structures can be surveyed using traditional topographic and hydrographic cross-sectioning methods, recent advances in acoustic multibeam and terrestrial LIDAR systems allow for detailed above- and below-water georeferenced cloud images of these structures.

c. Primary and local project control. Reference Chapter 5 of EM 1110-2-6056. EM 1110-2-6056 provides detailed guidance on establishing and maintaining primary control for coastal engineering projects. Figure 11-3 (taken from EM 1110-2-6056) depicts a typical reference baseline established for a beach renourishment project. Prior to the start of a project,

all local project control points (LPCP) should be connected to the primary project control point (PPCP), either by differential leveling or RTK. In accordance with the guidance in EM 1110-2-6056, every project should have at least one PPCP that has established orthometric and tidal elevation relationships. Supplemental LPCPs may be PBMs or TBMs. Beach renourishment projects often have established (permanent) baselines with PBMs at 500 ft or more intervals. During construction, temporary hubs may be set between these PBMs at 100-ft intervals. Jetties, seawalls, breakwaters, etc. will also have a PPCP from which local construction control (LPCPs) can be established during maintenance work. Appendix G in EM 1110-2-6056 contains an actual example of control established for a Wilmington District project—"Fort Fisher Shore Protection and Beach Stabilization Project."

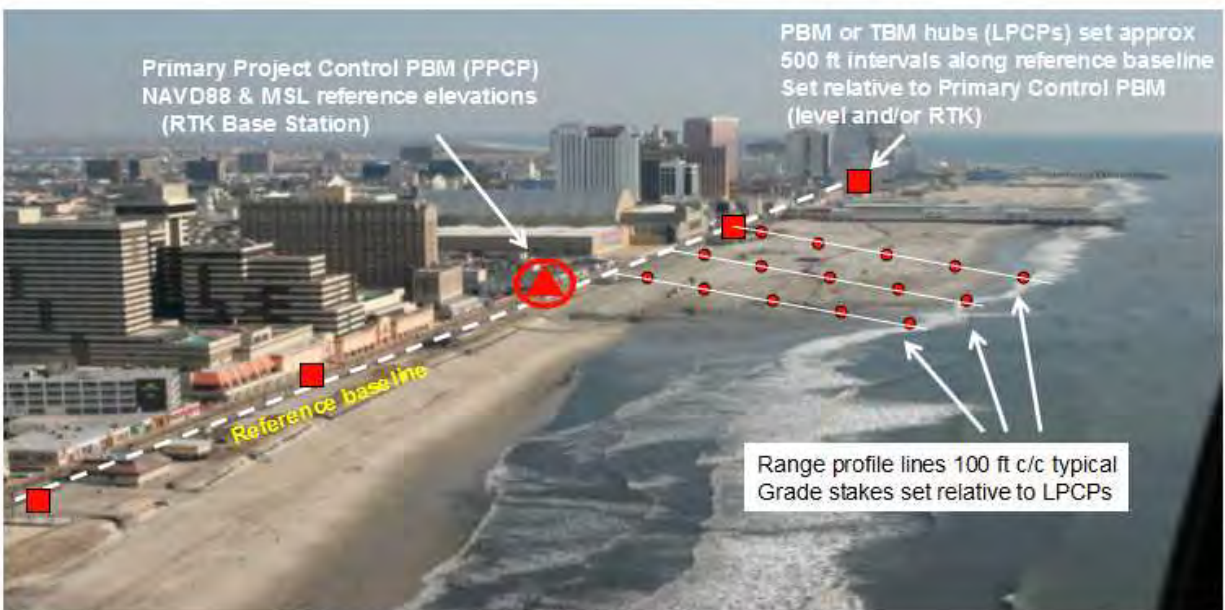

Figure 11-3. Primary and secondary construction control on reference baseline. Beach renourishment project at Atlantic City, NJ. (Philadelphia District)

d. Elevation and grading accuracy. Depending on the survey technique, the accuracy (or propagated uncertainty) of elevation data along the profile will be highly variable. Topographic sections can generally be measured to 0.1 ft relative to the baseline PBM or TBM control. In the surf zone, topographic elevation accuracy begins to degrade in deeper water, notwithstanding the temporal variations of the seabed due to the turbulent surf. Thus, any "accuracy standard" for measurements in the land sections or surf zone cannot be specified given the short-term changes of the topography, which may occur in minutes after the observation. The deviations shown in Table 11-1 for these areas are representative of the typical survey accuracies over changing, irregular terrain, not repeated survey comparisons. Therefore, any stated "accuracy" is temporal and valid only for the point in time the observation was made. Offshore hydrographic depth measurement accuracy will vary with the depth of water. In the near-shore surf zone, extreme vessel motions must be corrected with either inertial and/or inertial-aided GPS methods. Table

11-1 also lists recommended datum connections and relative accuracies generally required on beach and shoreline protection projects. Since the accuracies are shown relative to a local fixed reference monument (LPCP), they will approach the achievable repeatability levels for beach fill measurement & payment surveys. This table is intended as general guidance. Site-dependent factors may require variations from this guidance.

Table 11-1. Recommended Survey Elevation Accuracies Common to Various Shore Protection Projects.

Bench Mark/Activity	Std Dev (95%)	Relative to
Primary Project Control Point (PPCP)	± 0.25 ft	Regional NOAA/NGS NSRS and NOAA tidal NWLON network
Local Project Control Points (LPCP)	± 0.02 to 0.05 ft	PPCP
Construction TBMs (hubs, nails, etc)	± 0.02 to 0.05 ft	LPCP
Beach fill construction grade stakes	± 0.1 ft	LPCP or TBMs
Beach fill grading tolerance	± 0.5 ft	LPCP or TBMs
Beach profile surveys		
Topographic—land section	± 0.25 ft	LPCP or TBMs
Topographic--surf area ¹	± 0.4 ft	LPCP or TBMs
Hydrographic--surf area ¹	± 0.5 to 1 ft	LPCP or TBMs
Hydrographic—offshore ¹	± 0.25 to 0.5 ft	LPCP or TBMs
Feasibility or Sand Transport Studies	± 0.2 ft	LPCP or TBMs
Offshore borrow area excavation	± 0.5 to 1 ft	PPCP
Shore protection breakwater caps	± 0.2 ft	LPCP or TBMs
Offshore stone placement (jetties, breakwaters, etc)	± 0.5 to 1 ft	PPCP, LPCP, or TBMs

¹. Assumes carrier phase RTK and/or inertial-aided GPS measurement systems are employed. Direct Measurement Techniques (i.e. CRAB or sea sled) accuracies in deeper water may be better than those shown. Temporal accuracies in varying beach and surf areas are a function of the survey technique and equipment, not those based on any repeated testing.

e. Horizontal accuracy. Relative horizontal accuracies obtainable using carrier phase RTK topographic or hydrographic survey methods should be in the order of ± 0.2 to 0.5 ft; again relative to the local PPCP or LPCP bench mark. These horizontal tolerances are acceptable for breakwater or jetty surveys. On beach profile surveys, acceptable horizontal tolerances are much larger, especially in the surf zone where visual topographic alignment is used by a wader with a level rod. In such cases, variations from the intended profile line can exceed 5 ft or more (i.e. cross track error). These variations are usually not significant to the end user or volume computation.

f. Florida standards for beach erosion control studies. The Florida Department of Environmental Protection (FL DEP) has published survey data collection and processing standards for erosion control projects—"Monitoring Standards for Beach Erosion Control Projects," (DEP 2004). The intent of these standards "is to provide for systematic physical data collection monitoring of erosion control projects along Florida beaches for beach management and regulatory purposes." These standards cover topographic and bathymetric profile surveys, bathymetric surveys for open water areas, aerial photography, and aerial photography for environmental assessments. An excerpt of some the requirements for beach and offshore profiling surveys in this document are listed in Table 11-2 below.

Table 11-2. Florida DEP Standards for Beach Profiling Study Surveys.

<u>Hydrography</u>	<u>Upland Profiles</u>	<u>Offshore</u>
Horizontal Datum (1990)	HARN NAD83 (1990)	HARN NAD83
Vertical Datum	NAVD88	NAVD88
Reference PBM Accuracy	$\geq 2^{\text{nd}}$ Order	$\geq 2^{\text{nd}}$ Order
Control Surveys of Reference PBMs	[meet NGS guidelines for 5-cm GPS-derived heights]	
Profile Spacing	[approximately 1,000 ft typical or as specified in SOW]	
Accuracy-Horizontal (RMSE)	± 3 ft	± 2 ft
Accuracy-Vertical (RMSE)	± 0.16 ft	± 0.2 to ± 0.5 ft
Coverage	150 ft landward of vegetation 3,000 ft or (-) 30 NAVD88	
Density along profile	25 ft and breaklines	25 ft and breaklines

Off-line Horizontal Deviation	NTE ± 3 ft	NTE ± 30 ft
Topo-Hydro Time Difference	[NTE 14 days]	
Maximum Allowable Sea State	n/a	3 ft

SECTION I

Coastal Engineering Survey Techniques

This section describes the various techniques used by Corps districts to perform surveys in near shore areas. Advantages, disadvantages, and recommended quality control procedures for the various survey methods are outlined.

11-4. Differential Leveling Methods. A standard differential level and level rod is a simple method for obtaining beach profiles out to wading depths in the surf zone, as shown in Figure 11-4. A differential level can be set up at any location on the beach suitable for backsighting on a PPCP or LPCP, and foresighting elevations on a 25 ft expandable level rod along the profile line. Stakes (range poles) need to be preset along the range profile line so the rodman can maintain alignment visually. Distance along line can be measured using a lightweight tape or string tag line fixed at the baseline LPCP monument. Alternatively, a hand-held EDM can be used to measure the distance from the LPCP to the level rod. (Older stadia distance methods are rarely used today). The rodman progresses out along the profile range and shots are taken at preset distances (e.g., every 10 or 25 ft) or breaks in grade. If a tag line is used, even increments along line can be taken. The level instrumentman records the tagline/EDM distance and rod elevation in a field book. The rodman wades out into the surf as far as possible while holding line. Final grade elevations to the required reference datum are reduced manually in the field book. These profile offset and elevations are then input to a spreadsheet for subsequent conversion to georeferenced coordinates or volume computations. If an EDM (reflector type or reflectorless) is used, then increments are paced by the rodman and actual distances shot by the EDM. Some specifications require the use of electronic data collection in order to ensure cross track error tolerances are maintained and to reduce the chances of error in manually recording elevations.

a. Limitations on this method include large grade differentials between the LPCP (often atop a dune) and the project grade. The instrument "HI" needs to be set near the LPCP elevation in order to maximize shots on the 25-ft rod at the furthest offshore reaches. In some cases, a TBM will need to be established on the intermediate beach area. Maintaining horizontal alignment relative to the required profile line becomes difficult for the rodman out in the surf zone. Deviations of 5-ft or greater are common. Alongshore currents affect the ability of the rodman to maintain adequate tension on the tape or tagline, thus affecting the accuracy of the offshore distance measurement.

- b. The rodman has a most difficult position on this crew. He must maintain tag line intervals, hold alignment visually on the range, and stabilize a 25-ft rod vertically.
- c. A three-man crew is generally required on these surveys—an instrumentman, rodman, and helper to set ranges and maintain the fixed end of the tag line or operate the EDM.
- d. An EDM is the recommended method for measuring distances along line, as opposed to a tag line. Tag line measurements over 500 ft degrade rapidly; thus, an intermediate turn point may need to be set along line. Similarly, since some hand held EDMs have limited ranges, an intermediate point may need to be set along the profile line.
- e. The major advantage of leveled profiles is its use in daily beach fill monitoring surveys. Sometimes the rodman can reach the offshore limit of fill by wading. A small kayak or inflatable raft may also be used to obtain the deep water shots—Figure 11-5. This eliminates the need to launch a full-size survey boat each day to monitor construction progress and verify fill grades.



Figure 11-4. Beach profiles using a level and tagline for control. On left photo, fixed end of tag line is held at TBM next to grade stake. Range poles or grade stakes are used for visual alignment. Rodman on right photo is shown with 25-ft level rod.

- f. Elevation accuracy of shot points is usually at around ± 0.2 ft since a differential level is being used. The level should be frequently "peg tested" since backsight and foresight distances are highly unequal. Levels should also be "closed" between two LPCPs on the baseline—before and after profile line elevations are observed. Horizontal accuracy relative to the profile line is typically ± 5 ft.



Figure 11-5. Kayak for obtaining deep water points just beyond wading range in Gulf of Mexico. Note that updated (2012) Corps policy requires surveyors to wear approved PFDs when working on a platform such as this.

11-5. Total Station Methods. The Total Station (Figure 11-6) is used for controlling topographic survey position and elevation measurements on coastal engineering surveys. The Total Station is set up over a known PPCP or LPCP and backsighted on another PPCP or LPCP. The instrument is sighted on a reflector attached to a fixed height pole held by the rodman. The instrument records the horizontal and vertical angles to the reflector and automatically adjusts and records the absolute elevation of the point on the project datum. The Total Station does not directly provide alignment for the rodman. Normally range poles are previously set along the desired profile line using the Total Station software, and the rodman visually aligns himself out to wading depth. If the Total Station is set up over the range profile LPCP bench mark, then the rodman can be aligned using hand signals. Alternately, stake-out software in the data collector can be used to align the rodman along the profile line. Points are taken along the profile line at paced distances and/or at breaks in grade. Profile line distance and elevations are automatically recorded and georeferenced in the controller.

a. Limitations of this method are the distance from the LPCP on the baseline to the offshore end of the profile line. Often these distances (over 1,500 ft) may be beyond the range of the Total Station EDM and the trigonometric elevation accuracy. Having to establish supplemental Total Station traverse TBMs out on the beach may be involved or not feasible—especially during beach fill construction. In some instances, a Total Station may be used to control an offshore survey vessel out to limited distances. Tracking a moving reflector aboard the survey vessel is usually difficult, so this positioning method is rarely employed.

b. QC checks should include tests over an adjacent LPCP at a distance comparable to those observed on profile lines. Elevations should check to ± 0.2 ft.

c. A minimum crew of two persons is required for performing a Total Station beach survey. A robotic Total Station may be used for the topographic or wading portion. The advantage of a robotic is that the prism is constantly tracked by the total station, eliminating the

need to manually sight in the prism. The range of a robotic system will generally exceed a conventional total station. A robotic Total Station would entail use of a 2-m fixed height pole and remote controller.



Figure 11-6. Total station control of topographic beach profiles.

11-6. Real Time Kinematic GPS Methods. RTK survey methods are largely replacing the above leveling or total station techniques. RTK methods are readily adaptable for performing both the land topographic and offshore hydrographic surveys. In addition, both portions are on the same horizontal and vertical reference systems. Most coastal projects can be easily covered by a local GPS base station set over a PPCP. If a regional Real Time Network (RTN) coverage is available, then a local RTK base is not needed. A rodman obtains topographic range profiles with a GPS antenna/receiver atop a fixed-height 2-m pole. Both dune and offshore wading portions of the profile are simultaneously obtained. A survey controller (e.g., Trimble Survey Controller) records and transforms data using wired or Bluetooth connections to the GPS antenna. LPCP and range profile data are pre-entered into the controller and guidance/alignment is obtained using stake-out software. Profile data are recorded continuously along the range by time or incremental distances, along with grade breaks. Offshore hydrographic profile data is recorded using single beam and RTK systems as described in Chapters 4 and 7. Recorded data from the topographic and hydrographic portions is transferred from the data collection

controllers (or HYPACK) to a computer/CADD system for subsequent processing or volume computations.

a. Wading depths in the surf zone are limited by the antenna height and ability to water-proof recording instruments. A 3- or 4-m fixed height pole allows for deeper depths to be obtained if deploying off a floating platform (e.g., an inflatable raft).

b. If a permanent RTK base station has been established, or a RTN network is available, only one person is required to perform the topographic portion of the beach profile. A two-person crew is recommended in remote areas outside the established beach fill construction zone. When working in an active construction zone, where there are bulldozers, front-end loaders, etc. working, a second person is highly recommended to maintain a lookout for moving construction equipment. It is common practice for the dredging company to require crews to check in with the beachfill foreman prior to working in the active area. Dredging companies may also require all personnel working on a project to complete required safety training.

c. RTK QC check shots should be periodically taken on baseline LPCPs—e.g., every few profile lines. A tolerance of ± 0.2 ft is typically allowed.

11-7. Coastal Amphibious Research Buggy (CRAB). The CRAB is a topographic survey platform developed by the ERDC Coastal and Hydraulics Laboratory (CHL) at its field research facility in Duck, NC. It has been in operation since the 1980s. As shown in Figures 11-7 and 11-8 it is a self-powered rigid platform capable of surveying profile lines out to approximately 20 feet of water. The top of the platform is positioned using either Total Station or RTK methods described above. The elevation of the grade is projected down from the top, with applicable tilt corrections applied. Data are recorded and processed by a GPS controller device. The CRAB is limited to hydrographic surveys of smooth sand beaches due to its size, instability, lack of mobility, and slow speed. The CRAB is especially useful during winter conditions, where sharks are present, or in contaminated water. Its ability to survey out to 20 ft water depths provides an accurate measurement profile in these depths—estimated at ± 0.3 ft at the time the measurement is taken.

a. Great Lakes Dredge & Dock Co. currently operates CRABs on renourishment projects to obtain offshore survey data during beach construction. RTK elevation data at the upper platform is recorded on a Trimble Survey Controller. When pre- and post-fill sections are run at 100-ft spacing, typically, 30 to 50 sections can be run in one day. The CRAB can obtain some beach topo data but upland data to the dune line is obtained by traditional RTK topo methods.

b. The CRAB is typically operated by one person, who both drives the platform and performs the data acquisition. A second person may be required for safety reasons. Mob and demob costs are high; thus, the CRAB is most effective when deployed on long-term beach renourishment projects.

11-8. Survey Sled Methods. Sled survey systems were developed to collect continuous survey data from the dry beach, through the surf zone, and into the nearshore. Similar in concept to the

CRAB platform, sled surveys provide direct elevation measurements from the seabed. The system consists of a mast some 30 ft high with a cluster of reflective prisms or a GPS antenna at the top--see Figure 11-9. The mast is mounted to an aluminum frame sled. The sled is pulled along predetermined lines across the beach and into the nearshore by a LARC to a maximum



Figure 11-7. CRAB. Hydrographic survey platform used for research purposes by the ERDC Coastal and Hydraulics Laboratory research facility at Duck, NC. (ca 1980s)

depth of about 30 ft. A land vehicle may be necessary for winching the sled back onto the beach from the water. As the sled is being towed, a Total Station set over a LPCP is used to track the prism on top of the mast and record the horizontal and vertical positions at regular time intervals. Using GPS, a cable is extended from the sled to the LARC. Alternatively, the GPS positions can be broadcast to the shoreline via radio telemetry. The sled provides a relatively accurate method of collecting complete profile surveys. Approximately 25 - 30 minutes are required to sample along a 1,000 ft profile line. Thus, only 10 to 20 profiles can usually be obtained in one day. Sled surveys are now rarely performed by USACE districts.

a. Surveys can be conducted using this method in areas where the beach is easily accessible. Survey sleds do not perform well on irregular bottoms or areas where rock or reef outcroppings are prominent. Such conditions can cause the sled to tip over or become snagged. Sleds have been known to be stable in breaking waves up to 15 ft; however, since the sleds are typically towed by LARC through the surf, the working conditions are limited by that of the towing vessel.



Figure 11-8. One of the CRABs operated by Great Lakes Dredge & Dock on a 2011 Beach Renourishment Project at Jacksonville Beach (Duval County), FL. The dredge in the background is shown at the beach pump-out site. (Jacksonville District).

b. Sled surveys are extremely labor intensive, requiring a crew of six (6) or more persons. Given the high survey cost, the Corps and a few A-E firms rarely utilize this survey method. Like the CRAB, the sled provides accurate elevation data in the surf zone where traditional single-beam hydrographic surveys degrade. Those specifying requirements for sled surveys must weigh the added costs versus the required profile accuracy.

11-9. Nearshore and Offshore Profile Acoustic Measurement Methods. Single beam hydrographic survey systems and methods outlined in Chapter 4 are used to obtain profile data offshore of the topographic survey limits. When possible, hydrographic surveys are performed at high tide in order to maximize overlap with the land topographic section. Survey or study requirements will normally specify the outer limit by distance (e.g., "3,000 ft from the baseline range monument") or to a maximum depth of closure (e.g., "-30 ft NAVD88").



Figure 11-9. Sled profiling system—LARC ("Lighter, Amphibious, Re-Supply, Cargo") with towed sled. Used to collect profile data through the surf zone and into the nearshore areas. (New York District)

a. Survey vessels. USACE Districts have used nearly every type of boat on beach profile surveys. These range from 12-ft open skiffs to 65-ft survey boats. In general, conventional survey boats in the 19- to 26-ft range are employed. The type of vessel selected is highly dependent on the surf zone depths and potential adverse wave actions at the near-shore end of each line. Due to the possibility of taking in water while broaching in the surf (and perhaps overturning), the vessel stability, power, and instrumentation must be designed to extricate and recover from such an event. Boat maneuverability in the surf zone turn is also a major factor—dual outboard engines are strongly recommended on larger vessels operating in these environments. For these and other reasons, recent trends have been to utilize smaller platforms to perform these surveys. These include use of jet skies and inflatable rafts.

b. Single Beam and multibeam systems. Since individual profiles are being surveyed in relatively shallow water, single beam systems are used almost exclusively for these surveys. If additional bottom coverage is required, multibeam systems may be used at maximum array width (e.g., 8 to 15 times water depth), recognizing that data on the outer arrays is marginal in shallow water. Both single beam and multibeam systems become marginal in surf zones with aeration in the water; thus, maximum coverage using topographic methods and direct measurement techniques is obtained in these surf zones in order to minimize acoustic coverage. Traditional single beam echo sounders are used on larger vessels—e.g., Ross, Odom, Reson. On smaller platforms portable systems specifically designed for shallow water surveys are often used—e.g., the Seafloor Systems, Inc. HydroLite system that has both positioning and depth measurement components in a compact unit.



Figure 11-10. Inflatable raft on left is used on near-shore beach profile surveys. Water-proofed shallow-water depth sounder, RTK, and a laptop running HYPACK are installed aboard the raft. The Corps survey vessel on right must have sufficient engine power to maneuver through surf zones during turns at the inshore end of each profile line.

c. Positioning and orientation systems. Survey vessels may be positioned using either code phase DGPS or carrier phase RTK methods. Kinematic positioning is the preferred method for determining water levels during the hydrographic portion of the survey because it is nearly impossible to obtain accurate water levels from a remote tide staff or automated gage. Larger boats may have POS/MV and IMU systems to correct for vessel motion; however, larger vessels may be limited in how close they can get to the surf zone. Inertial orientation systems may or may not be used on a smaller open raft or 'jet ski' type survey platform. Due to the dynamic nature of the surf zone, heave should be measured with an IMU, MRU, or RTK.

d. Data recording. Survey data are recorded on a survey controller or a laptop using HYPACK software. HYPACK is used to process and edit the data and merge land and water profile sections for subsequent applications. During processing, overlap points should be verified to meet specifications for the project. Whether the hydrographic or wading portion of the survey is done first, the distance from the reference baseline should be noted such that it can be used to ensure adequate overlap is being obtained.

11-10. LIDAR Bathymetry and Topography Methods. A state-of-the-art LIDAR system coupled with high precision carrier phase RTK and inertial positioning is a technology that can be utilized for conducting hydrographic and topographic beach surveys. An airborne hydrographic LIDAR system operates by emitting laser pulses from an airborne platform that travel to the water surface. For each laser pulse, some of the light is reflected from the surface to onboard receivers. The remaining energy propagates through the water column, reflects off the sea bottom, and returns to the airborne sensor. The time difference between the surface light return and the bottom return corresponds to water depth. The maximum depth detection is limited predominately by water turbidity. As a rule-of-thumb, the system is capable of sensing depths equal to two or three times the visible depth. Sounding densities can be adjusted by flying higher or lower at different speeds or by selecting multiple scan widths. With the ability

topographic and hydrographic survey data an airborne LIDAR system can simultaneously conduct complete beach and structure surveys above and below the waterline, and is particularly useful in areas where human access is difficult or restricted. The technology is also a useful tool for post-storm erosion assessments. Data acquired from LIDAR can be used to generate vertical profiles, cross sections, contours, and volumetric analysis.

a. Airborne LIDAR is capable of rapidly collecting relatively dense survey data over large areas in a short amount of time. However, the technology is highly dependent on water

clarity and should not be considered for areas with chronic high turbidity. Costs pertaining to system mobilization can be high and may be a limiting factor when considered for surveying small projects. It is beneficial to schedule surveys along with other projects in the same general vicinity to share and minimize mobilization costs. Users of LIDAR survey data should possess data processing equipment and software capable of handling large data sets.

b. LIDAR observations are not as accurate as profile data obtained from traditional topographic and acoustic survey systems described previously. LIDAR accuracy also degrades in the turbulent surf zone. Therefore, LIDAR systems are not used for construction measurement and payment purposes. However, they are far more efficient than traditional survey methods for broad area coastal studies. LIDAR accuracies are typically ± 0.5 ft on land and ± 1 ft under water. Increased accuracies are possible with lower altitude flights, such as from unmanned aircraft or helicopters.

c. Additional details on the principles of LIDAR measurements can be found in the IHO Manual of Hydrography (IHO 2005).



Figure 11-11. RTK measurement and payment surveys for beach renourishment projects.

SECTION II

Coastal Project Applications

This section contains examples of construction surveys on coastal projects. Beach fill measurement and payment techniques are described.

11-11. Beach Renourishment Measurement and Payment Surveys. During beach fill construction, profile surveys are continuously (i.e., daily) performed to monitor grade levels, both on the beach and into the water. As shown in Figure 11-12, beach profile sections are established from the profile templates and baseline control provided in the construction drawings. Each profile section (and template) is referenced to a point on the baseline and has a fixed azimuth—see Figure 11-13.

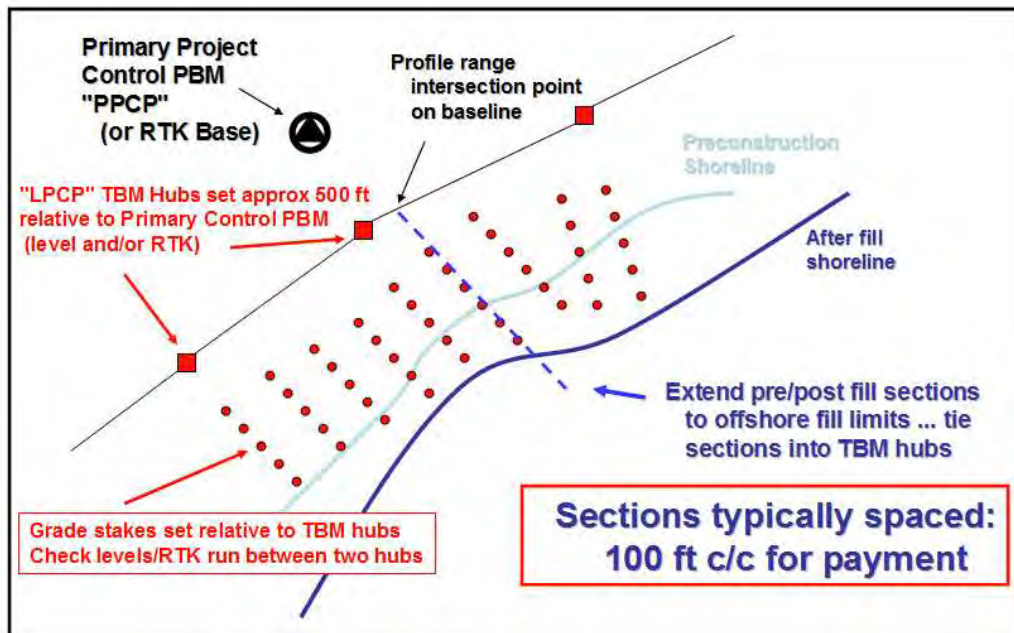

Figure 11-12. Profile sections for beach fill measurement & payment. Profile lines are defined in position and azimuth relative to established baselines and/or fixed PBMs.

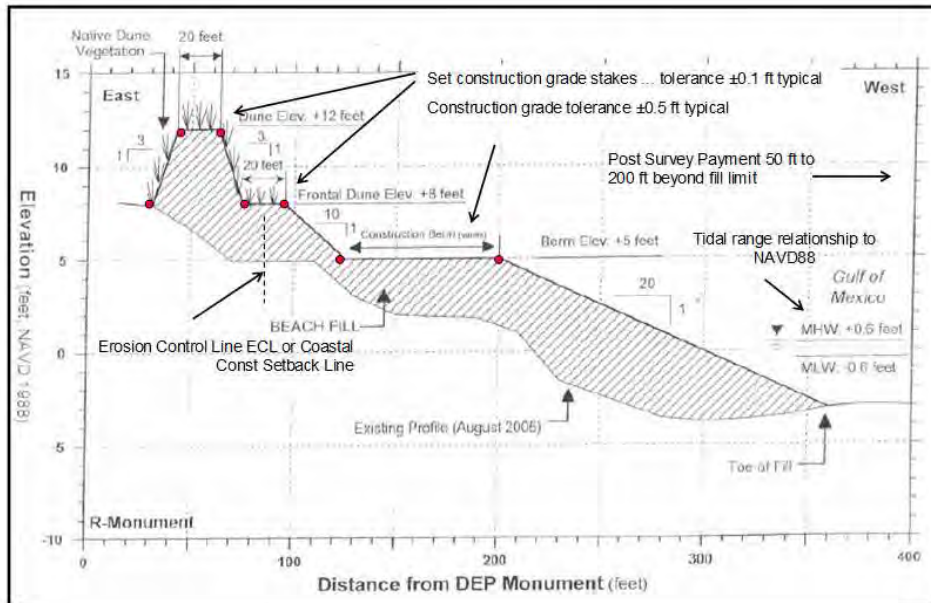

Figure 11-13. Typical beach profile template referenced to a permanent "DEP Monument." The X-Y location and range azimuth for the reference monument were shown on a separate table.

a. RTK control. Most renourishment projects now employ RTK for all operations. This includes not only the surveys but also dredging operations at the borrow site. An established RTN may be used or a permanent local RTK base station set up for the project. As in any survey, RTK site calibration is an essential QC requirement using either a RTN or local base station.

b. Grade staking. (Figure 11-14). A variety of grade stakes are used during beach fill contracts. In sandy conditions, long metal rods are often used with top flagging visible to the dozer operators. Grades and tolerances are marked with color-coded flagging on the rod. Any grade staking survey technique may be used to set the elevation on the grade stake relative to the profile template. This includes differential levels, total stations, or RTK. In general, RTK methods are now the most economical and efficient. Survey controllers are pre-loaded with each profile template on the project. Grade staking software and displays in the controller will automatically compute the required elevation at any point along the template and at breaks in grade. Grade staking can be minimized or eliminated if machine control systems are employed on the project.

c. Survey time requirements. Given the rapidly changing nature of a beach, surveys must be completed before and after placement. Pre-fill (i.e., "pre-dredge") surveys are normally performed within two (2) weeks of intended placement. Often weather delays will require a repeated pre-fill survey to stay within the two-week window. Erosion from a large storm may

require repeating the pre-fill survey prior to placement. Post-fill surveys are usually required as soon as possible after the material has been placed and graded—ideally the same or next day to verify grade before pipelines are relocated. If sections are not within tolerance these surveys are repeated. On site "field-finish" data processing and plotting is essential.



Figure 11-14. Setting a metal grade stake with driving hammer during active beach fill construction. Pre-drilling the stake hole with a portable auger makes for easier driving. RTK stake out observations are used to determine grade levels relative to the template along the profile range. Ft. Pierce Beach Renourishment Project. (Jacksonville District)

d. Volume computations. (Figures 11-15 to 11-18). Beach fill volumes for construction payment are generally computed using Average End Area routines. Surface-to-surface TIN methods have little application, other than perhaps in assessing quantities of material removed from an offshore borrow area. Although profile sections are run on 100-ft intervals, the sections are not necessarily perpendicular to the reference baseline; thus, each template is shifted relative to the next template. Range profile azimuths may not always be parallel. In addition, successive templates may change slopes or elevation grade intersects. This variability requires extreme care in setting up volume computations in software. Given the variability in template elevations and orientations, the "Standard HYPACK Method" of beach volume computations is recommended. (Refer to HYPACK User Manual, "Cross Sections & Volumes—CSV" (HYPACK 2012)). This Standard HYPACK Method is specifically designed for Average End Area volumes of sections that have different alignments (i.e., non-parallel) and different lengths, as is typical on beach fill sections non-perpendicular to the reference baseline.

e. Borrow area surveys. Borrow area surveys may be especially critical, especially in environmentally sensitive areas. Often sand sources are limited and dredging is restricted to specified locations and depths. In some cases, overdepth dredging penalties may be imposed. Both single beam and multibeam survey methods are used for these surveys. RTK control is recommended.

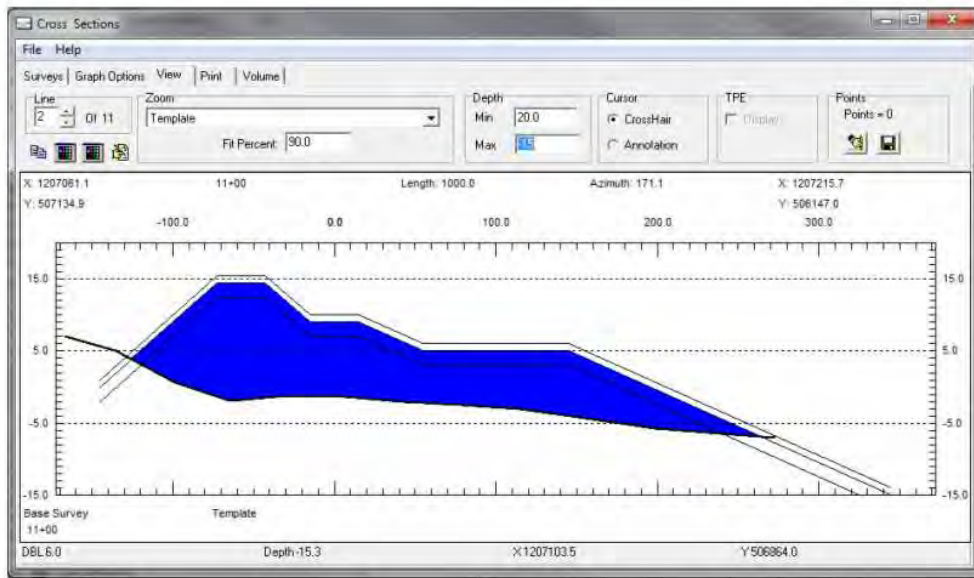

Figure 11-15. Pre- and Post-Fill beach profile templates in HYPACK "Cross Section & Volumes" program. Also shown are tolerance templates above and below grade.

11-12. Offshore Jetty, Breakwater, and Groin Surveys. Surveys for these structures are performed for design, construction, and maintenance. Traditional topographic survey methods entailed establishing a baseline atop the centerline of the structure (if above water), and cross-sections then run (by tag line, total station, or RTK) normal to the structure every 50 or 100 ft O/C, extending past the toe of the foundation stone (Figure 11-19). Depths are measured by lead line, level rod, or sounding pole at a relatively dense interval. Echo sounding (vertical single beam or multibeam) may be used if return signals are adequate in the rock structure. During stone placement, submerged areas may be surveyed using hydrographic single beam methods.

a. The above manual survey techniques are extremely labor intensive and often hazardous. They are only used when more modern survey methods are impractical.

b. Survey of offshore breakwaters or jetties are now more economically and accurately performed using a variety of remote sensing techniques. Multibeam sonar heads may be rotated to assess underwater conditions of the armor or foundation stone. On inaccessible or broken breakwaters, low-altitude airborne, vessel mounted mobile, or terrestrial LIDAR surveys may be conducted to map the rock placement and voids above the surface. The LIDAR topography and multibeam hydrography models may then be merged in order to evaluate the overall condition of the structure and estimate repair quantities needed. Examples of some USACE projects employing these technologies are shown in Figures 11-20, 11-21, and 11-22. Refer also to the underwater structure investigation survey examples in Chapter 9.

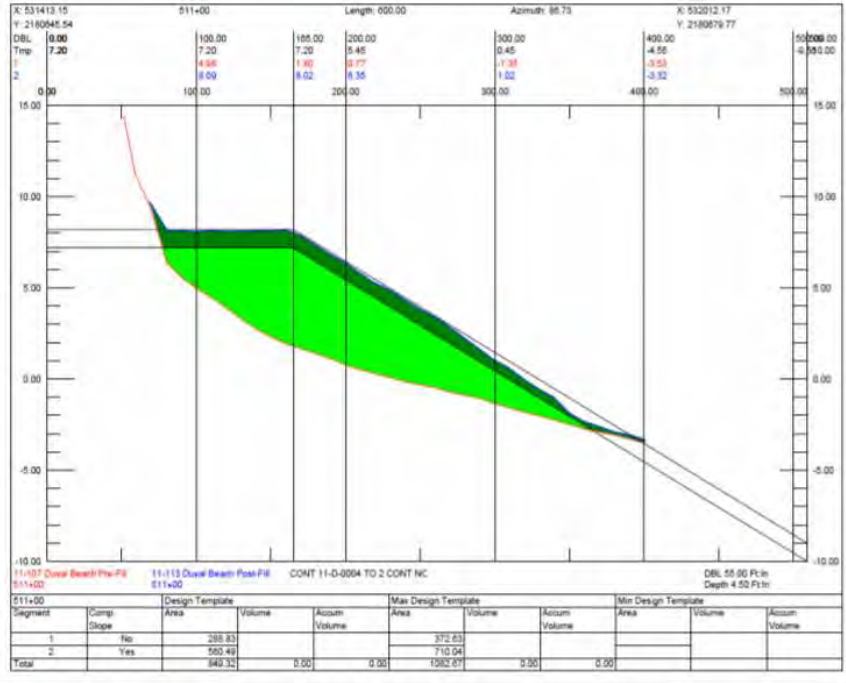

Figure 11-16. Pre- and post fill beach quantity computations. Output details material relative to the design template and the upper (1-ft) tolerance template. A slope sloughing compensation option (i.e., box cut) is calculated. Duval County beach renourishment, Station 511+00, August 2011. (Jacksonville District)

ST. JOSEPH PENINSULA EROSION CONTROL PROJECT														
VOLUME SUMMARY - JANUARY 3, 2009														
STATION 23+00 - 31+00														
SD Station Name	SD Date	AD Station Name	AD Date	Total Req. Area (sf)	Total Req. Volume (cy)	Tolerance Area (sf)	Total Tolerance Volume (cy)	Additional Pay Area (sf)	Additional Pay Volume (cy)	Total Pay Volume (cy)	Accumulated Pay Volume (cy)	Non-Pay Area (sf)	Non-Pay Volume (cy)	Accumulated Non-Pay Volume (cy)
2300	12/29/08	2300	01/03/09	66.62	0.0	0.00	0.0	0.0	0.0	0.0	0.0	0.00	0.0	0.0
2400	12/29/08	2400	01/03/09	464.79	965.9	22.92	42.2	4.2	7.7	1035.6	1035.6	0.00	0.0	0.0
2500	12/29/08	2500	01/03/09	503.76	1760.1	53.64	141.3	27.4	58.3	1969.8	3025.6	0.00	0.0	0.0
2600	12/29/08	2600	01/03/09	632.70	1915.6	67.63	261.1	21.3	90.0	2266.7	5292.3	0.99	1.6	1.6
2700	12/29/08	2700	01/03/09	676.71	784.8	95.92	159.9	23.3	31.9	446.2	5738.5	128.36	91.4	93.1
2800	12/29/08	2800	01/03/09	613.36	2160.0	67.54	337.6	17.0	74.1	2601.7	8340.2	154.14	97.1	168.1
2900	12/29/08	2900	01/03/09	623.72	2292.5	29.08	212.7	0.0	31.3	2336.5	11176.7	0.89	342.5	1008.6
3000	12/29/08	3000	01/03/09	133.76	1259.9	0.00	61.6	0.0	0.0	1261.5	12438.2	0.00	1.6	1010.3
3100	12/29/08	3100	01/03/09	0.00	246.1	0.00	0.0	0.0	0.0	246.1	12684.3	0.00	0.0	1010.3
				Total Pay Volume (cy)	12,684.3									
				Total Non-Pay Volume (cy)	1,010.3									
				Total Placed Volume (cy)	13,694.6									

Figure 11-17. Typical Beach Renourishment Project Volume Computations. 100-ft section accumulations for payment. Includes pay area quantities, tolerance area quantities, non-pay area quantities, and (not shown) slough/box cut allowance quantities. (Gahagan & Bryant, Inc.)

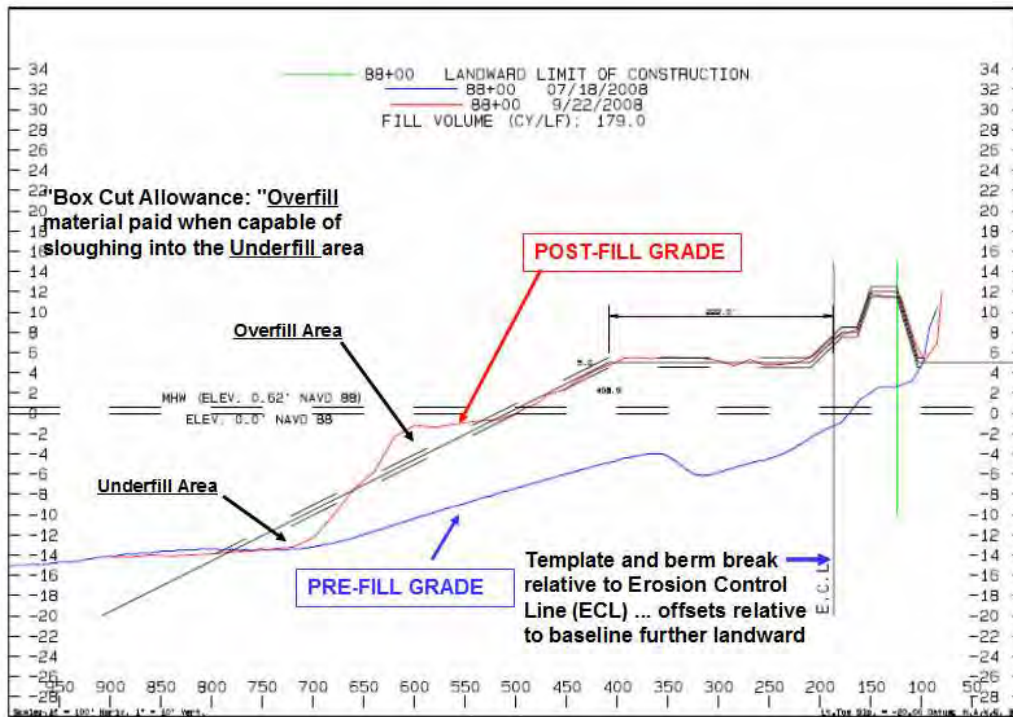

Figure 11-18. Typical pre-and post-fill sections with excess material placed at surf zone for eventual sloughing to equalize final section. (Manson Construction and Gahagan & Bryant, Inc.)

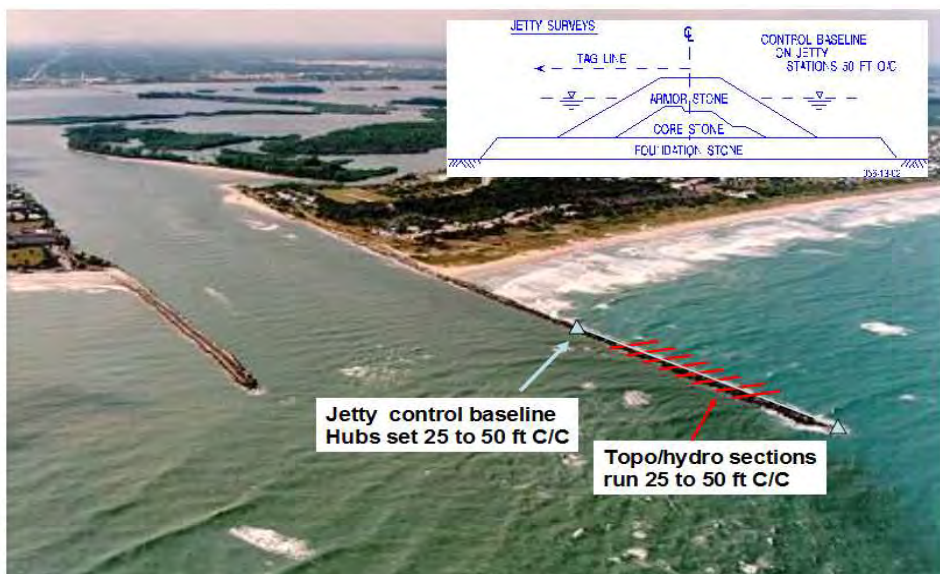

Figure 11-19. Jetty and breakwater surveys—traditional baselines set along structure for cross sectional surveys.

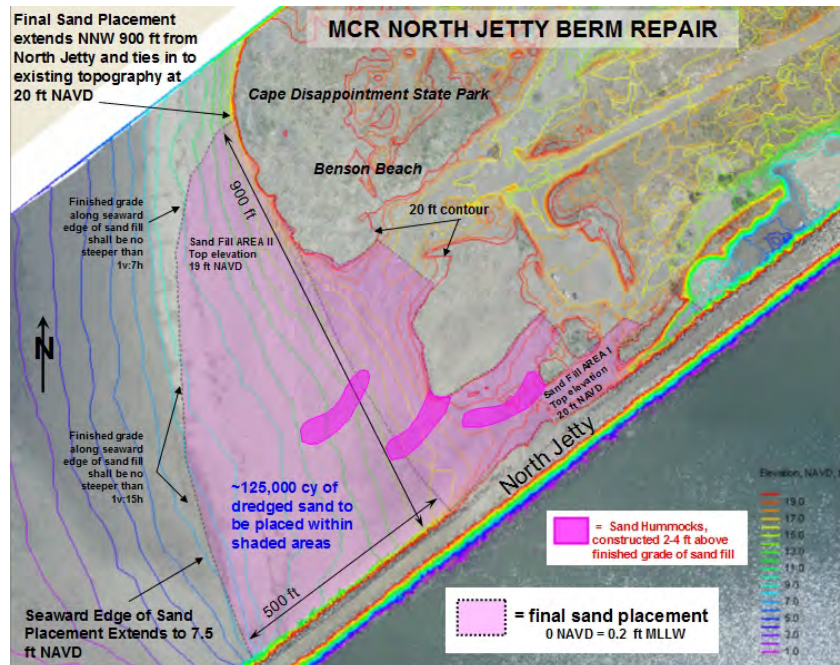

Figure 11-20. Surveys for North Jetty Berm Repair, Mouth of Columbia River (MCR). Surveys conducted for this project included vessel mounted multibeam to cover the underwater portions of the jetty, airborne LIDAR, beach profiles and jet ski single beam to cover the surf zone. (Portland District)

11-13. Subsurface Probing. Hydrographic survey crews are occasionally tasked to obtain either dry rod or washed offshore probings, often over potential sand sources for proposed beach renourishment projects, or to obtain depths to hard rock. When such geotechnical data are intended for use in contract plans and specifications, DGPS survey positional accuracy is required for the probe location and offshore elevation reductions. Sample field notes are shown in Figure 11-23.

EM 1110-2-1003
30 Nov 13



Figure 11-21. Combined terrestrial laser scanner with multibeam hydrographic surveys of Harbor of Refuge Light - Lower Delaware Bay. (Philadelphia District)

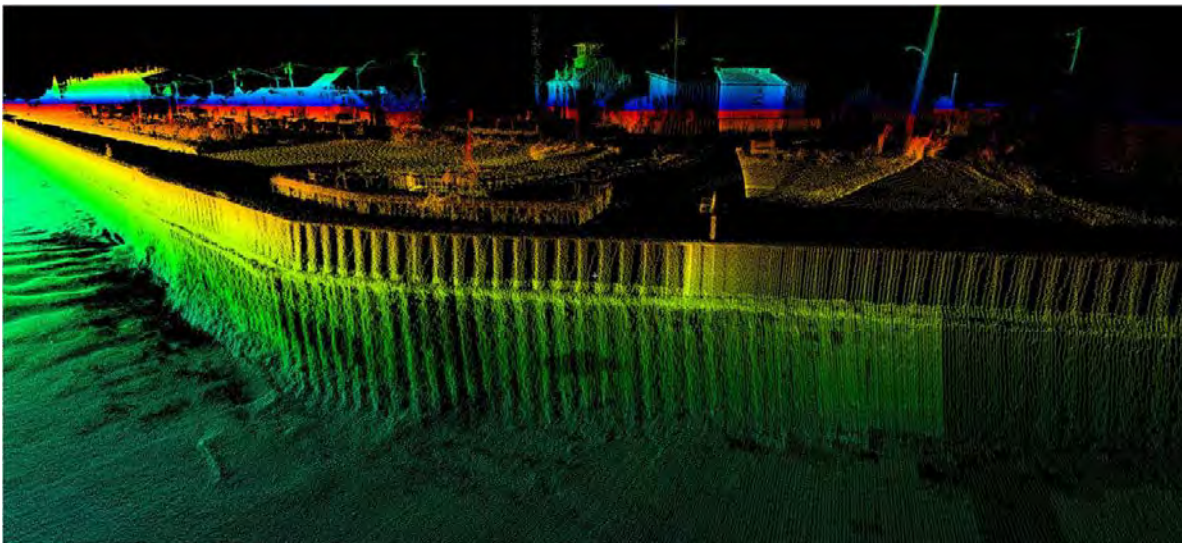

Figure 11-22. Combined vessel mounted mobile laser scanner with multibeam hydrographic surveys of sheet piling structure – Manasquan Inlet, NJ (Philadelphia District).

30 Nov 13

STA	+ ROD	H.T.	ROD	SDG.	PROBE	ELEV	REMARKS:	10 MAY 70
24-1						30.05		
	5.15	35.20						
10+00			5.6			29.6	TOP GROUND	
					0	29.6	TOP GROUND	
					12.2	17.4	TOP HARD MATERIAL, UNABLE TO PENETRATE	
12+00			6.6			28.6	TOP GROUND	
					0	28.6	TOP GROUND	
					14.2	14.4	TOP ROCK	
			9.2					
13+50				5.0		26.0	WATER SURFACE OF CANAL	
					0	21.0	TOP WATER	
					5.0	26.0	BOTTOM CANAL	
					16.0+	21.0	BOTTOM CANAL	
BA-2			5.05			10.0	REQUIRED PROBING	
						30.13	PUB. ELEV = 30.13	
NOTE: THE FIELD NOTES WILL SHOW IF DRY ROD OR PUMP USED FOR PROBINGS. IF PUMP USED SEE CRITERIA FOR DRIVE BORINGS AND PROBINGS WHICH WILL BE FURNISHED WITH REQUEST FOR SURVEY.								

Figure 11-23. Probing field notes.

a. Sub-bottom profiling by seismic reflection methods. Seismic reflection systems operating between 400 Hz and 14.0 kHz are useful for continuous high-resolution profile recordings of the top 30 m of material below the sea floor. The high-energy signal will penetrate and reflect from interfaces between nonhomogeneous materials. The receiving package will detect the reflected signals and convert them into a profile recording. The display is real time with relatively high ship speeds of 10 to 12 knots. Typical resolution is 0.5 m. When properly calibrated, the systems can also be used for obtaining bathymetric profiles. Depth of sub-bottom penetration varies inversely with frequency. Sub-bottom depths over 200 ft have been recorded.

(1) Sub-bottom reflection data have been very useful in numerous investigations in which information pertaining to the sub-bottom strata is important. These include predredging investigations, pipeline route locations, and offshore foundation investigations.

(2) In operation, an instrument package is towed which contains both transducer and receiver. Outputs can be either analog strip charts or in digital form, which facilitates post-survey processing that enhances resolution. Other systems rely on ship-mounted transducer/receivers. For these, resolution can be reduced by ship heave, but accelerometer packages are available to measure heave for correction purposes.

b. Sub-bottom profiling by Ground Penetrating Radar (GPR). Recent experience with GPR indicates that under some conditions this technique can provide sub-bottom information. Radar designed to obtain subsurface information usually operate at frequencies between 20 and 500 MHz. To best resolve echoes from subsurface interfaces, broadband antennas are used to radiate a very short duration pulse. Low-frequency (20-100 MHz) antennas with high radiated power (0.5-2 kW) provide the greatest penetration and in most situations would be best suited for sub-bottom profiling. The depth that radar can penetrate is strongly limited by attenuation in the water and bed material, with greatest signal loss in electrically conductive water and sediment. High attenuation limits the use of this technique, making it best suited for surveys in low-conductivity fresh-water lakes and streams. On-site conductivity measurements should be taken before using radar equipment. These measurements will estimate the radar penetration. The radar frequency used will also be a trade-off between resolution and penetration. Plots of amplitude versus time for the returning pulses are usually compiled into a graphic display, producing an apparent profile of subsurface reflectors and interfaces. When the electrical properties (dielectric permittivity) of a layer are known, propagation time to the base of the layer can be converted to layer thickness, with resolution of about 0.5 m. More information on GPR techniques may be obtained from the US Army Cold Regions Research and Engineering Laboratory (CRREL).

11-14. Offshore Confined Placement or Borrow Area Surveys. Offshore material placement areas (Figure 11-24) are frequently surveyed during planning, design, construction, and maintenance phases of a project. The most frequent surveys are conducted during dredging operations and for subsequent general condition purposes. The purposes of these surveys are varied. Normally, offshore submergent areas are periodically surveyed to monitor material placement grade during construction--to ensure minimum depths and area limits are not exceeded. Surveys are also performed to locate any misplacement of dredged material outside the disposal area limits. Subsequent surveys may be required to monitor settlement or material movement. Offshore borrow area surveys are similar; however, they are used to monitor the amount of material removed from the site--usually a sand source for renourishment projects. Emergent disposal areas in offshore locations and upland confined disposal areas are periodically surveyed during construction and later to monitor settlement and available quantities for additional placement.

a. Submergent dredged material placement areas and borrow areas are typically cross-sectioned at 100- to 200-ft spacing. Survey lines are run 200- to 1,000-ft outside the disposal area limits to monitor for any misplaced material. Material quantities can be computed using either average-end-area or grid methods.

b. In the past, single, vertical beam echo sounders were used for disposal area surveys. For deep water disposal areas, multibeam survey systems are now recommended. Multibeam systems can be set at maximum beam width to obtain maximum swath widths of coverage. Note that high frequency multibeam systems may have limited depth ranges—around 150 to 200 ft on most systems. Therefore, low-frequency single-beam systems will have to be used to reach depths up to 2,000 ft.

c. During construction, offshore disposal areas may be surveyed weekly or biweekly. Subsequent monitoring surveys are performed at quarterly or annual intervals, depending on any environmental requirements/restrictions that may have been imposed on the use of the area.

d. Upland disposal areas are surveyed using standard topographic techniques. Fixed baselines are established along the top of the confining dikes and cross-sections are run internally within the disposal area and externally into the water. Total station or RTK survey methods may be employed. In cases where the confined material has not settled, a small skiff may be needed to obtain measurements. Extreme caution should be exercised when spoil material has only crusted on the top--the rodman should use a life jacket and/or lifeline should there be a danger of breaking through to water-suspended material. A sounding pole with a bottom plate may be needed in soft material.

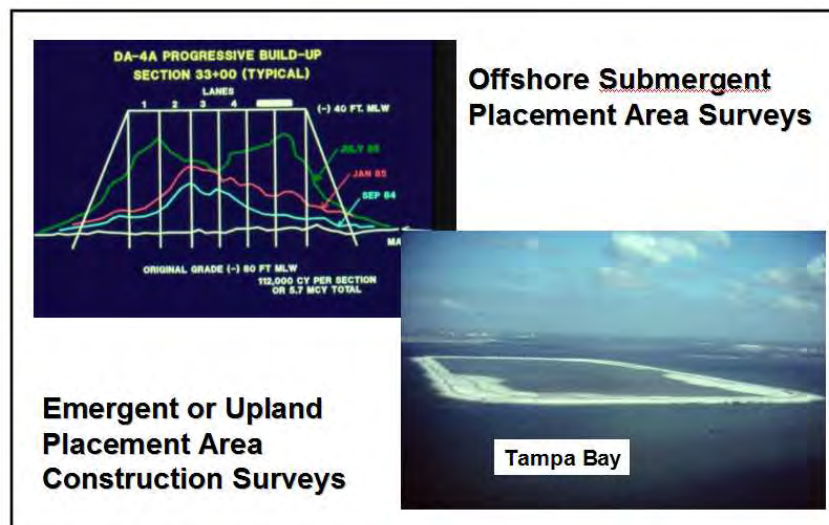

Figure 11-24. Submergent and confined disposal area surveys.

SECTION III

General Guidance on Survey Requirements for Coastal Engineering Studies

This section outlines some general planning considerations relating to coastal engineering studies and their supporting survey requirements. This guidance was developed in the 1990s by the Coastal Engineering Research Center (now the Coastal and Hydraulics Laboratory). Thus, some portions may refer to dated survey methods. It is applicable only to coastal studies—it does not apply to beach fill placement construction surveys.

11-15. Coastal Engineering Studies. Coastal project studies of all types typically require extensive and accurate beach and nearshore survey data. Acquiring such data is often a labor intensive, time consuming, and complex process, and it is often difficult to establish the success and quality of the data set after the fact. Part of this problem can be attributed to a lack of consistent guidance for planning, conducting, and properly evaluating coastal surveys. Guidance is lacking especially for defining survey requirements based on the eventual end-use of the data. Studies are performed to monitor completed beach renourishment projects along the Atlantic and Gulf Coast--common in Jacksonville, Philadelphia, Norfolk, Wilmington, and New York Districts (Figure 11-25). Surveys are performed during design to locate suitable offshore borrow area sand sources.



Figure 11-25. Beach renourishment project ca 1975--Miami Beach, FL (Jacksonville District).

a. The exact end use of a coastal study may vary, but the essential goal of most coastal survey projects is to characterize the features of a relatively large study area, often the equivalent of several square miles. The principal type of survey used to accomplish this has been a series of profile lines and this is the most familiar type of technology still in use. In addition, the same basic technology frequently can be used or applied in more than one way to produce results, which vary in accuracy, coverage density, time, cost and other factors. Interest in these approaches arises from concerns about the numerical inaccuracies of interpolating between traditional profile lines and the possibility of significant bathymetric anomalies being hidden in the blind areas between profiles. Alternate approaches that could provide denser data coverage even at the expense of having less precision in individual measurement points may produce an overall result that better represents those features important to the project.

b. It is important to match the surveying scope, including the selected technology and procedures, with the true requirements based on the eventual data use. It is essential that survey specifications originate from the project's functional requirements and that the requirements are realistic and economical. However, too frequently a survey method is pre-selected based on a combination of peripheral factors, and this selection, in effect, defines the type, accuracy and characteristics of the data. Surveying a coastal structure, for example, requires a different effort than documenting general changes on a dynamic beach several times a year; reconnaissance or condition surveys may be able to use less accurate, but broader covering, faster technologies than "payment" surveys. If numerical models require profile-type data eventually to be extrapolated and converted into gridded depths or contours, the data can be collected in that manner to start with if the need is identified as part of the surveying scope. Data end-users must have and be able to communicate a complete understanding of their needs.

c. A related issue is who should be responsible for specifying, defining, or otherwise deciding among choices for each technical question. In almost all cases the in-house survey branch will ultimately be responsible for accomplishing the work, but limitations on the number of in-house crews and their workload often result in the work being contracted. For most reconnaissance, planning, design, and similar projects, the surveys are performed by A-E or specialty surveying firms under task order contracts. For construction progress, as-builts, or pay measurement, especially on dredging-related projects, the surveys are often part of the construction contractor's scope of work and are spot-checked by in-house crews.

d. In both basic scenarios, however, a critical point is that the work is often done by outside personnel not under the direct supervision or coordination of the end users, e.g., the study manager. Once a survey request goes from the originator/end user into the survey branch/contract system, there is a danger that the originator no longer has control nor input, and the final surveying contract specifications and standards may not address the original requirements. This type of situation underscores the importance of ensuring a high level of awareness and communication on the part of all the people involved in the data collection planning and decision-making processes for a project.

11-16. Accuracy Requirements for Studies. The accuracy of beach and nearshore survey data is often stated as a major concern, but accuracy frequently means different things to different groups of surveyors. Accuracy should be broadly viewed as more than the ideal or theoretical accuracy associated with a particular instrument or system. It includes operational influences such as the site conditions, overall field collection and data reduction procedures used, and any constraints due to datum problems, lack of monuments or other control, or historical incompatibility. Project data planning goals should be less directed toward improving absolute or ideal accuracy and more toward properly understanding, characterizing, and communicating the errors and limitations in existing or proposed systems and procedures. The calculation and presentation of realistic error bands on all data is consistent with and supports the trend toward risk-based analyses in project design. Although they may recognize the need to do so, many end-users are unable to identify a specific use or type of analysis, which directly translates into a requirement for nearshore hydrographic survey accuracy, spacing or a similar standard. In addition, situations sometimes occur in which ambiguous project goals, together with the inherent lack of precision in many coastal engineering design tools and other inputs such as wave data, result in project personnel feeling that survey precision is not their highest priority. This point can be especially contrasted by surveys in the planning community with the requirement for 3rd order accuracy in real estate maps and the dramatic effect which inaccuracies in that type of data (i.e. building floor elevations and foundation positions) could have on the calculation of project storm damage reduction benefits. It is often recognized that a more formal, comprehensive error analysis to establish the effect of survey limitations on a particular project or calculation should be performed in order to better assess risk and uncertainty, but resources are not typically available for the necessary effort.

11-17. Data Density, Formats, Processing and Archiving. The issue of data density or coverage is closely related to accuracy and end-use. A general phrasing of the problem might be: "what changes, features or other data are really important?" Airborne LIDAR technologies are capable of rapidly collecting data over entire surfaces rather than profile-by-profile. However, the trade-off is in additional processing time and computing power, QA/QC difficulties in terms of checking such data, and very significant storage requirements. Procedures for intelligently editing or "decimating" can be developed, but the basic question is more one of knowing how much data is necessary to adequately characterize the site or problem of interest.

a. A negative aspect with the more highly pre-processed data is that the user is no longer directly involved in data reduction tasks such as corrections for datum, tides, or waves and does not develop an intuitive appreciation for the variability and limitations of the data. Because the raw survey data itself is no longer "handled" directly by the end users and survey data files often are not plotted and inspected for their own merit, major errors may not be noticed until problems subsequently develop while performing calculations or interpreting model results. By that point, the survey data has been so co-mingled with other potential data problems and issues that it may take considerable time and effort to identify the survey as the source of error.

b. Whether the ultimate purpose of a set of surveys is planning, design, construction or pay, the intermediate step in all projects is some type of volumetric change calculation. These

calculations are most often performed using a software program, which automates some type of algorithm involving interpolations, point-by-point differencing and extension of two-dimensional area changes to three-dimensional volumes.

11-18. Coastal Processes Affecting Surveys. The coastal margin is a unique physical environment and as a result, it presents unique challenges for collecting and interpreting all types of data including survey data. The coast is the triple interface of the atmosphere, ocean and land (EM 1110-2-1100). Surveying this interface cannot be done through the straightforward application of conventional terrestrial surveying principles; neither can adequate data be collected exclusively with traditional hydrographic surveying techniques. Both approaches - used with innovation, creativity and intuition - are necessary to properly characterize the beach and nearshore environment.

a. Unlike most terrestrial sites, the coastal margin changes and moves constantly, even within time frames as short as the time of the field survey itself. The coast is said to exist in a state of dynamic equilibrium. That is to say, it is shaped by a unique balance among wind, waves, tides and sediment characteristics (EM 1110-2-1100). The concept of dynamic equilibrium suggests that significant changes to one of these parameters can disturb the balance and produce a new system. Unfortunately for coastal engineers, planners and surveyors, sufficiently significant changes can occur within a time frame of hours, days and weeks.

b. Understanding the equilibrium condition at a particular site is further compounded by the fact that the natural forces producing the equilibrium may not be those observable on the survey day, or even the average condition observable over a short period of time. Often extreme events or perturbations in the average energy condition are responsible for the equilibrium profile or other features observed weeks or even months after the event. This phenomena may be more important to the analyst reviewing the data set and drawing conclusions for design, but it is useful knowledge for the surveyor planning the program and collecting data in the field as well. A sufficient familiarity with the natural process can ensure that modifications to a scope are made, if appropriate, in the field based on conditions observed and that any atypical events or features are noted which might make data interpretation more meaningful to the problem.

c. Very frequently in coastal planning and design, historical data is either sparse or of questionable accuracy. The reasons for this are varied, but certainly can include a lack of past interest or concern in a site and its problems, or a lack of attention to properly archiving and describing a collected data set. One result of this problem is that the coastal professional may be required to hindcast a historical condition from a very limited present or short-term past data set, and then use the hindcast condition for forecasting a future condition. This process of predicting the future based, not on the "true" past but on a "prediction" of the past is not unique to coastal projects, but is certainly more common than in most other fields of engineering design.

d. This section briefly summarizes those coastal processes that most affect the collection of survey data and is necessarily a very brief overview because of the complexity of the subject. In addition, while coastal processes occur at most sites, the range and significance vary greatly

from site to site and requires specific analysis of the local conditions as part of the scoping phase. In addition, the problems associated with the physical environment are made more complex by the fact that different data end uses may require different accuracies and density.

11-19. Overview of Coastal Processes. As noted, the coastal margin is a dynamic system that can change significantly during the time it takes to complete the field portion of a survey program. The survey program planner must have an understanding of those features most likely to change, the range of variation, and the time scales associated with each. Some aspects of time scales are straightforward and familiar to most people collecting and using coastal data. For example, it is well understood that if the water level itself is being used for a reference plane, as in most hydrographic segments of a coastal survey, that level must be continuously corrected for tidal variation if the survey extends over an appreciable portion of a tidal cycle. For most traditional surveying methods, in contrast however, wave height variations usually are not individually corrected.

a. Time scales. Classical oceanography introduced this same concept of a relationship between the length and time scales of various physical processes, called Lagrangian times and scales. Simply stated, the time frame over which a process is observed or measured should be consistent with the length scale over which the effect is felt. For example, a rough order of magnitude of the time scale for tidal cycles is $\sim 10^4$ sec. At typical water velocities, the length scale of this single cycle should also be very roughly 10^3 to 10^4 ft. This type of analysis would suggest, therefore, that if a mile-long section of shoreline would require more than three to four hours ($\sim 10^4$ seconds) to survey, tidal influences could be significantly different at the starting point of the survey than at the ending point. While the process time scale influence may not be important for every survey or site, it is necessary to perform some type of scale analysis in order to establish the level of importance. This is especially true in using newer surveying technologies for which the influence of various factors is either unknown or unfamiliar to many users.

b. Waves. At most sites wave energy is probably the primary natural forcing function responsible for shaping the bathymetry and shoreline alignment (EM 1110-2-1100). As waves approach the shore and move into shallower water depths, the water particles that have been set into orbital motion by the waves increasingly "feel" the sea floor. One effect of this is to transform a portion of the kinetic energy of the traveling waves into potential energy. The visible effect of this energy transformation is that the waves shoal or increase in height, growing steeper and more peaked, until finally they become unstable and collapse or break in the nearshore.

(1) A second equally important, but perhaps somewhat less obvious effect, is that the friction imparted to the sea floor by the transforming waves produces a shear stress which may be sufficiently great to lift sediment into the water column and make it available for transport and redistribution. The wave-induced shear is usually too transient and non-directional to drive the sediment very far. However, once it is lifted into the water, other background currents such as those resulting from the angle the waves make with the shoreline, from tides, or direct wind

stresses can take over and move the suspended sediment. In any case, the result is that the waves can move sufficient unconsolidated sediment to reshape the bathymetry. The altered bathymetry then produces a new set of water depths, which, in turn, transform the wave field differently. This iterative and continuous interaction between incoming waves and the nearshore bottom is one of the principal sources of complexity and dynamic change in the coastal environment.

(2) A further complicating factor in this process is that the waves are not constant either in height or period. For illustration and rough planning purposes, waves are often characterized as regular or "monochromatic," meaning that successive waves in the incoming field are assumed to have the same, constant height and period, and the wave form is sinusoidal in shape. These assumptions result in mathematical simplifications which allow for the use of linear wave theories. However, real waves exist in an irregular spectrum composed of inter-mixed heights, periods, translation speeds and steepness. To an observer at a fixed point in the water, the passing waves appear as a varying time series. In addition, the time series observed on one day, at one location may be very different the next day at the same point, or the same day, but a few thousand feet away. A detailed analysis of such waves requires statistical techniques and so-called non-linear or "higher order" wave theories.

(3) The reason such analyses are important and are performed in spite of their complexity is that wave energy and resulting sediment transport potential is proportional to the square of the wave height ($\sim H^2$). Alongshore variations in the wave time series cause gradients in energy that can be very significant in influencing local shoreline alignments and on the impact of any existing or proposed coastal structures or other alterations. In addition, because the water depth at which a wave begins to be influenced by bottom friction depends on the wave height and steepness, the different waves in the time series in a given section of shoreline will break over some cross-shore width (i.e. a range of depths) representative of the degree of variability in the wave series. This determines the width of the visible "surf zone" at any time and location, but is important because it may affect total sediment transport volumes and the position and prominence of features such as submerged bars or run-out channels.

(4) The wave climate at a particular location is a combination of locally generated wind waves and (usually) longer-period waves that have traveled over some appreciable distance of open water. Local seas respond rapidly to changes in local winds and the arrival timing of waves produced by distant events is unpredictable. As a result, the time scale for significant changes in wave energy and its effect on local bathymetry is often on the order of hours or days. Field work begun at a project site before a weather front moves in, and completed a day or two after it passes when the waves have laid down enough to resume work may be capturing very different and unrelated conditions.

(5) Because of the mathematical relationships among different components of all statistical distributions, even limited data or observations-- as long as they are consistently taken-- can provide insight into the entire wave climate at a site. One parameter often used is the significant wave height, " H_s ," which is defined as the average height of the one-third highest waves in the series. This is a convenient approximate field measure because experience has

shown that this is the height an observer will tend to notice anyway when watching a variable time series. Accuracy can be improved by observing the waves for several minutes and comparing their heights, from trough to crest, to some reference object such as a range pole, rod, piling, pier, boat railing or similar. An associated representative wave period is determined by measuring the total time it takes for several waves (typically 20) to pass a fixed object and dividing the total by the number of waves. Several trials should be measured and compared. Lastly, a very rough approximation of the water depth (d) at which a wave will begin to shoal and break is a depth between three-quarters and one full wave height (i.e. solitary wave theory breaking limit, $H_b \sim 0.78 d$).

c. Currents. Along most sections of open coast, any sediment suspended by wave action typically is transported parallel to the shoreline by background currents. These currents most often result from the fact that the breaking wave crests form some angle with the shoreline. Waves surging obliquely toward the beach and reflecting at the complementary angle produce net alongshore water movements which are roughly proportional to the size of the approach angle and the square of the wave height. These currents may be either reinforced or opposed by other water movements resulting from tides, local wind shear on the water column, or any similar force, which results in a dynamic setup or mounding of the water surface differentially at one location compared to another.

(1) Although alongshore transport currents are relatively weak under average conditions, they are persistent and can be much stronger during storms when the wave heights are larger and the seas more directional. The result is that the total sediment transport integrated over the width of the nearshore zone and over a long time period can be very substantial. Average annual transport can range from as little as 30,000 to 40,000 cu yds to as much as 300,000 to 400,000 cu yds; values as large as 700,000 cu yds are not unheard of. The direct measurement of sediment transport has been attempted using traps and various optical instruments, but the techniques are cumbersome and results have been mixed. Most often transport is either predicted using one of several mathematical formulae based on wave height and angle (e.g. energy flux), or it is inferred from dredging records at nearby inlets, comparative surveys, or balancing sediment budgets.

(2) Because most sediment transport is related to the wave climate at a particular location and time, the instantaneous transport magnitude and even the direction may change as the wave field changes. The most common pattern of change is a seasonal one in which higher energy periodic winter storms approach a shoreline from a consistent direction (e.g. northeasters, etc.) which is different from the prevailing wave direction under average, milder summer conditions. In such cases there will be associated reversals in transport direction for varying lengths of time. The magnitudes of the transport in each direction are algebraically combined to produce values known as the net annual transport magnitude and direction. This approach is useful in many analyses, but can be misleading in others. As can be seen, if the transport is roughly balanced in both directions, the net value can be very small even though many hundred thousand cubic yards are actually moving in the system.

11-20. Profile Closure. Coastal project designs usually focus on that portion of the beach that is actively changing or fluctuating. This zone is defined by seeking to identify the opposite situation: those boundary points-- landward and seaward-- which appear to be stable, or at least changing very infrequently. Such a point on the seaward end of a beach cross-sectional profile is often referred to as the closure point or closure depth. To establish an accurate assessment of an entire beach system, surveys should extend from the dune crest seaward to depth of closure, which ranges from between 5 and 18 m depending upon location. The coastal engineering community has been criticized recently for implying that this closure point is a point of 'no change' or one at which 'nothing' ever happens. Sediment actually may be transported offshore and onshore through the closure point, and other changes may be occurring over longer periods which are too subtle to be distinguished using typical surveying techniques. Perhaps a better perspective is that some point on the profile exists at which the net change is either not measurable or is of no engineering significance. In any case, it is desirable that surveys (using any technology) should extend seaward to the closure depth. The best method for determining this point is experience gained by looking at past data to assess any changes noticed. Because the bathymetry and profile shape is determined largely by the wave climate, there should be some theoretical relationship between closure depth and wave height. One such suggestion is that the limiting offshore depth can be approximated as twice the height of the extreme wave likely at the site. Obviously, judgment and experience must be applied to the manner in which the wave height is estimated.

11-21. Tides and Other Water Level Changes. Tidal fluctuations and other water level changes are of particular interest in coastal surveying when the water surface itself is used as a measurement reference plane. The basic procedures for accounting for water level variations, using tidal benchmarks and adjusting to specific datums are familiar to most survey personnel and are extensively discussed within this manual. Only two additional points will be mentioned in this chapter: project variability and vertical changes from other sources.

a. Most tidal reference stations are located in sheltered waters, not on the open coast. It can be challenging to correlate the water level data at an interior reference station to the fluctuations at a beach location. Tidal phase and amplitude shifts are related to hydraulic distances and not necessarily geographic proximity. For example, because of complexities in bathymetry, channel characteristics and frictional effects, beaches at the opposite ends of a barrier island may have very different, even anti-correlated, water level variations when compared to the same tide station equidistant between them on the bay side of the island. Simultaneous observations at several locations in the project area (over a short time period) may be the only feasible way to assess the variability and correlate station data.

b. Other factors may affect local water levels on the open coast. One such influence is the dynamic setup caused by mass transport of water shoreward by waves after breaking. The still water setup is proportional to the wave height and can be as great as 5% of the breaker height (e.g. ~ 0.3 ft of super-elevation for 6-ft waves). The real difficulty with dynamic setup is that it is not uniform. No setup is present outside the surf zone (a "setdown" effect may even occur), and the setup increases inside the breaking point the closer to shore the depth is

measured. It may not be practical to make sufficient simultaneous observations to correct for setup. It should, however, be recognized as a potential source of uncertainty when data are analyzed and reported.

11-22. Survey Planning Considerations. Planning a data collection program obviously should take place in advance of the field effort. The objective of the planning process should be to carefully think through the eventual uses for the data and the manner in which they will be analyzed, develop the equipment and procedural requirements and anticipate as thoroughly as possible what the site conditions might be and what the data should look like. However, in most cases over-planning and over-specifying the work is just as counter-productive as not planning at all. Situations will always arise in the field that requires judgment and flexibility. The planning goal should be to communicate among all interests the purposes and uses for the survey and the ranges or thresholds of "typical" data, so that atypical conditions are noted and evaluated, even by further discussion while field work is in progress. A survey program ideally should be developed as a team effort among the data users, a representative familiar with the available surveying technologies and procedures, and perhaps a contracting representative if work will be done by outside sources. It is extremely helpful for the team to research and have access to any existing data, past surveys or similar information about a particular site or project area. Existing or historic information is valuable in several ways. A principal use of such data is to allow for a pre-project, preliminary analysis of the area to identify any natural features, shoreline segments or coastal structures which are of particular interest or potential impact on the final project, research effort or monitoring assessment. This type of analysis may suggest areas in which the survey data, however it is collected, may need to be more densely spaced to evaluate an important feature, or can be relaxed to save time and money in more uniform, less critical sections. Another value in carefully reviewing all existing information during planning is to help estimate the likely ranges in the various coastal processes discussed previously and to assess what impact they might have on the field effort. This could include the basic approach to tide corrections, expected wave climate, influences of nearby inlets, and the offshore extent of the data (closure depth). The review can also provide a preliminary look at the existing horizontal and vertical control in the area and the need for any additional benchmarks and/or datum conversions.

a. Planning variables. There may be a number of other factors that the planning team might consider along with any existing data or information about the site and personal experience in order to select appropriate surveying methods and to optimize the data collection effort. The goal is to provide the planning team with information which will allow for matching requirements to capabilities. It is recognized that in some cases surveys may be performed and the data used for more than one purpose over the planning and engineering design cycles of a major project. One type of survey may be better at the preliminary stages of a project and a different type for similar data, but at a more detailed stage of the work. Similarly, different considerations may be appropriate for a Project Feasibility study if the principal design approach will be based on historic conditions, or if it will be based on extensive numerical modeling.

b. Summary. The recommended approach is that a team-based planning process take place prior to specifying a survey method or field procedure. That planning process should begin with a preliminary characterization of the coastal environment at the project site, and proceed by using a decision-guiding matrix, or other local adaptation, in combination with the technical information on various technologies presented below in order to better define and match the requirements to the capability.

EM 1110-2-1003
30 Nov 13

THIS PAGE INTENTIONALLY LEFT BLANK

APPENDIX A

References

Section I

Required Publications

Public Law 92-582

Brooks Architect-Engineer Act; Public Law 92-582, as amended; 40 United States Code (U.S.C.) 1101-1104

Executive Order 12906

Coordinating Geographic Data Acquisition and Access: The National Spatial Data Infrastructure (NSDI)

WRDA 1992

Water Resources Development Act of 1992, (Rivers and Harbors Appropriation Act of 1915, 38 Stat. 1053; 33 U.S.C. 562)

WRDA 2000

Water Resources Development Act of 2000 (Section 554)

Office of Management and Budget (OMB) Circular A-16 Coordination of Geographic Information and Related Spatial Data Activities

Engineer Regulation (ER) 1110-1-8156

Policies, Guidance, and Requirements for Geospatial Data and Systems

ER 1110-2-1150

Engineering and Design for Civil Works Projects

ER 1110-2-1404

Hydraulic Design of Deep-Draft Navigation Projects

ER 1110-2-8160

Policies for Referencing Project Elevation Grades to Nationwide Vertical Datums

ER 1130-2-520

Navigation and Dredging Operations and Maintenance Policies

EP 1130-2-520

Navigation and Dredging Operations and Maintenance Guidance and Procedures

EM 1110-2-1003

30 Nov 13

EM 1110-1-1003

NAVSTAR Global Positioning System Surveying

EM 1110-1-2909

Geospatial Data and Systems

EM 1110-2-1100

Coastal Engineering Manual

EM 1110-2-1202

Environmental Engineering for Deep-Draft Navigation Projects

EM 1110-2-1416

River Hydraulics

EM 1110-2-1611

Layout and Design of Shallow-Draft Waterways

EM 1110-2-1613

Hydraulic Design of Deep-Draft Navigation Projects

EM 1110-2-1810

Coastal Geology

EM 1110-2-4000

Sedimentation Investigations of Rivers and Reservoirs

EM 1110-2-5025

Dredging and Dredged Material Disposal

EM 1110-2-6056

Standards and Procedures for Referencing Project Elevation Grades to Nationwide Vertical Datums

ERDC/TN EEDP-04-37

"Overdepth Dredging and Characterization Depth to Recommendations," Tavolaro, J. F., J. R. Wilson, T. L. Welp, J. E. Clausner, and A. Y. Premo. June 2007 Technical Note. Vicksburg, MS: U.S. Army Engineer Research and Development Center.

HEC RD 26 1986

Hydrologic Engineering Center (HEC) Research Document 26 (HEC RD 26), Accuracy of Computed Water Surface Profiles, 1986, incl. Supplemental volumes.

Section II Related Publications

Applanix 2005

"Hydrographic Surveying on the Ellipsoid with Inertially-Aided RTK," by: Peter Canter, Director of Marine Products at Applanix Corporation, Toronto, Canada and Louis Lalumiere, Senior Analyst at Applanix Corporation, Toronto, Canada, 2005.

Calder and Mayer 2003

"Automatic Processing of High-Rate, High-Density Multibeam Echosounder Data," Calder, B. and Mayer, L., Center for Coastal and Ocean Mapping and Joint Hydrographic Center, University of New Hampshire. *Geochemistry Geophysics Geosystems*, Vol. 4, No 6, 1048, 2003.

DEP 2004

"Monitoring Standards for Beach Erosion Control Projects," State of Florida Department of Environmental Protection, Division of Water Resource Management, Bureau of Beaches and Coastal Systems, March 2004.

Druyts and Brabers 2012

Druyts, M., and Brabers, P., "Nautical Depth Sounding, the Rheocable Survey Method," *International Hydrographic Review*, May 2012.

GeoAcoustics 2002

"GeoSwath Product Information Bulletin," GeoAcoustics, Ltd., UK (November 2002).

HYDRO International 2011

"Rheology as a Survey Tool," (Stijn Claeys), *HYDRO International Magazine*, May/June 2011.

HYPACK 2011

"HYPACK User Manual," ("HYPACK Hydrographic Survey Software User Manual"), (1582 pages), 2011 Edition, HYPACK, Inc., Middletown, CT 06457. [Note: This manual is updated annually; users should obtain the current version from the HYPACK web site]

IHO 2000

Special Publication No. 57, "IHO Transfer Standard for Digital Hydrographic Data." Edition 3.1.

IHO 2005

Publication C-13, "Manual on Hydrography," 1st Edition, May 2005 (Corrected to February 2011).

EM 1110-2-1003

30 Nov 13

IHO 2008

Special Publication No. 44, "IHO Standards for Hydrographic Surveys," 5th Edition, February 2008.

IHO 2010

Special Publication No. 52, "Specifications for Chart Content and Display Aspects of ECDIS," (March 2010).

JCGM 100 2008

"Evaluation of Measurement Data—Guide to the Expression of Uncertainty in Measurement," Joint Committee for Guides in Metrology (JCGM), International Bureau of Weights and Measures (BIPM), First Edition, September 2008.

L-3 SeaBeam 2000

"Multibeam Sonar Theory of Operation," L-3 Communications SeaBeam Instruments, 141 Washington Street, East Walpole, MA 02032, 2000.

LINZ 1999

"Provisional Swath Sonar Survey Specifications," John E. Hughes Clarke, Ocean Mapping Group, Department of Geodesy and Geomatics Engineering, University of New Brunswick, Canada, National Topographic and Hydrographic Authority, Land Information New Zealand (LINZ), Technical Report #2, August 1999.

McAnally 2007

McAnally, W., Friedrichs, C., Hamilton, D., Hayter, E., Shrestha, P., Rodriguez, H., Sheremet, A., and Teeter, A., (American Society of Civil Engineering (ASCE) Task Force on Management of Fluid Mud), "Management of fluid mud in estuaries, bay, and lakes. Present state of understanding on character and behavior," ASCE Journal of Hydraulic Engineering, Vol 133, No. 1, January 1, 2007.

NAVOCEANO/Hare 2001

"Error Budget Analysis for US Naval Oceanographic Office (NAVOCEANO) Hydrographic Survey Systems: Final Report for Task 2, FY 01," Hare, R., University of Southern Mississippi, Hydrographic Science Research Center, September 2001.

NOAA 2005

"The Navigation Surface and Hydrographic System Uncertainty at NOAA's Office of Coast Survey," Allen, S. and Ferguson, J., US Department of Commerce, NOAA. The Hydrographic Society of America, 2005.

NOS 2011

"NOS Hydrographic Surveys Specifications and Deliverables," NOAA, NOS, Office of Coast Survey, Silver Spring, MD, April 2011. [Note: This document is periodically updated--users should obtain the latest version from the NOAA NOS web site].

OCS 2011

"Field Procedures Manual," NOAA, NOS, Office of Coast Survey, Silver Spring, MD, May 2011. [Note: This manual is periodically updated--users should obtain the latest version from the NOAA OCS web site].

Odom 2008

"Odom Echotrac MKIII User Manual," Version 4.03, 23 May 2008; Odom Hydrographic Systems, 1450 Seaboard Avenue, Baton Rouge, LA 70810-6261.

PIANC 1997.

"Approach channels, a guide for design." General Secretariat of PIANC. Supplement to Bulletin No. 95. (1997), Brussels, Belgium.

POS/MV 2011

"POS/MV V5 Installation and Operation Guide," Revision 3, PUBS-MAN-004291, Applanix Corporation, 2011.

R2Sonic 2010

"R2Sonic Operation Manual," (Sonic 2024/2022 Operation Manual), Version 3, 2010; R2Sonic LLC, 1503-A Cook Place, Santa Barbara, California 93117

Sea Technology 2008

"Evaluation of Nautical Bottom Detection Techniques," (Stijn Claeys), Sea Technology Magazine, July 2008.

Teeter 1997

Teeter, A. M., "Development and verification of an intrusive hydrographic survey system for fluid mud channels," Dredging Research Program Technical Report DRP-97-1, June 1997, U. S. Army Engineer Research and Development Center, Vicksburg, MS.

EM 1110-2-1003
30 Nov 13

THIS PAGE INTENTIONALLY LEFT BLANK

APPENDIX B

Manual Depth Measurement Techniques

B-1. General Scope and Applications. Manual depth measurement techniques are used for many under water engineering and construction applications. These methods include use of hand lead lines, topographic level rods, 2-m GPS poles, and sounding poles. Manual methods are generally used where more efficient acoustic methods cannot provide adequate depth data or sufficient detail. Examples include: surveys of areas adjacent to piers, bulkheads, and offshore pile structures; near locks, dams, power plants, and river control structures subject to turbulence; detailed surveys of rock jetties and breakwaters; beach and dune profile surveys; surveys in shallow detention or retention ponds or water conservation pools; surveys in shallow wetland areas with thick bottom vegetation or mangrove; and surveys in areas where unconsolidated sediments are present. Manual depth measurement techniques are simply a variation of conventional topographic survey methods. However, unlike land-based topographic surveys, the geophysical properties of the bottom are not always visible or consistent. Any type of positioning method may be used to locate the depth measurement device—tag lines, total stations, and RTK being the most common. This appendix provides general guidance and procedural criteria for manual hydrographic survey depth measurements on engineering and construction projects.

B-2. Lead Line or Sounding Disk Measurement. Prior to the accepted use of acoustic depth sounding methods in the 1950's, lead lines were the Corps standard for hydrographic survey depth measurement, as illustrated in Figure B-1. At one time they were used as the calibration reference for acoustic soundings. Lead lines are simply surveyor tapes (chains) with a weight attached to the end. The length of these lines was usually less than 100 ft, or near project depth; however, much longer lines were used for deep-water surveys. Lead lines may be operated by hand, suspended from a bicycle wheel, or operated by a power winch apparatus--see Figure B-2. The water surface is used as the reference datum for the observations, as shown in Figure B-1.

a. General uses. Lead lines are to be used in situations where use of electronic sounding would be impractical, impossible, or give faulty results. Lead line sounding is especially suited for underwater investigation of rock or concrete placement; on the slopes of jetties, groins, and revetments; and near bulkhead construction. In such areas, echo sounding may be inaccurate or contaminated with noise from side echoes. Lead lines are to be used in conjunction with acoustic or nuclear density techniques to corroborate echo soundings. Also, for silty bottoms containing “fluff” that would give questionable echo sounding readings, a lead line may be required in a construction contract.

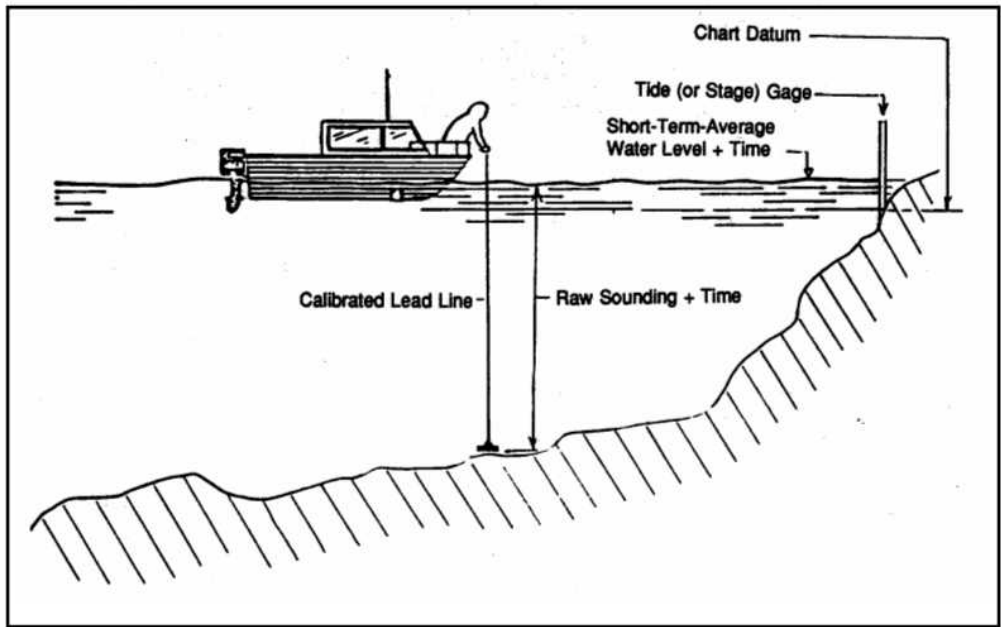

Figure B-1. Lead-line depth measurement

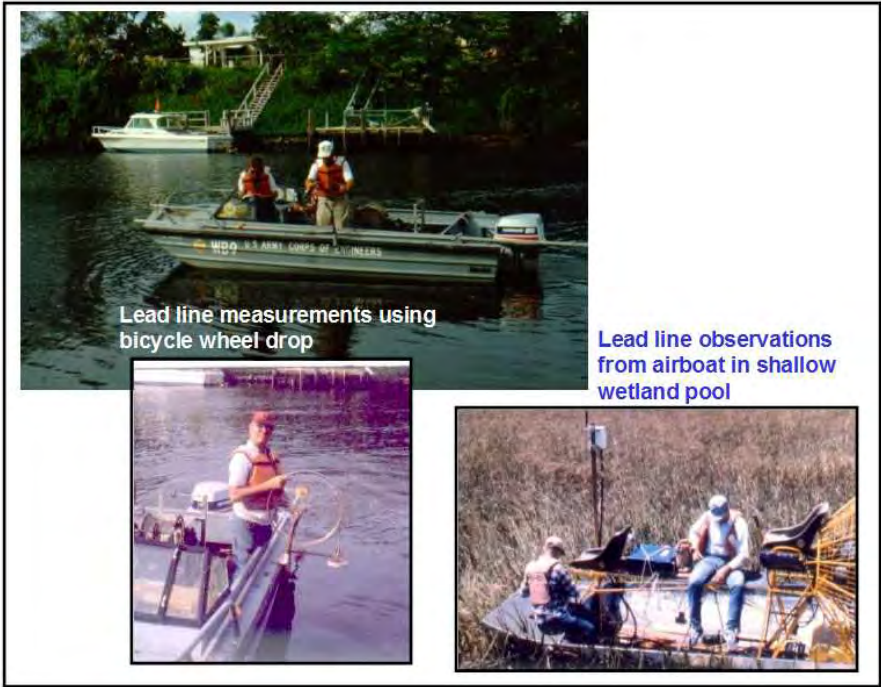

Figure B-2. Lead line measurements (Jacksonville District)

b. Line materials and dimensions. A variety of flexible metallic materials can be used to suspend a sounding lead. All must exhibit minimal stretch while under tension. Braided rope is never used for this reason. Standard 100-ft surveyor's chains/tapes have been configured into lead lines. Stainless steel wire rope, piano wire, and rubber-shielded electrical wire are often used. Since a lead line is rarely used in depths exceeding 50 ft, line stretching due to tension should be minimal. However, this should be checked when any type of braided material is used. For most USACE applications, lines need not be made any longer than 50 to 75 ft. Shorter lines may be made when used primarily on shallow-draft projects.

(1) The Coast and Geodetic Survey recommended use of a mahogany-colored tiller rope with a phosphor-bronze wire center (size 8 line--0.24-in. diameter). This type of braided line is suitable for continuous hand operation since the tightly woven cotton shroud prevents broken wire strands from protruding and causing hand injury. Procedures for seasoning and calibrating this type of line are covered in the NOAA Hydrographic Manual (1976).

(2) Flexible wire lines are best suited for mechanically reeled lead lines. A bicycle wheel rim (Figure B-2) or other large-diameter drum provides a rapid line payout velocity. A thin braided or solid core flexible wire is used for such devices.

c. Line marking. For most Corps applications, lines are usually marked at 0.1-ft intervals throughout their length. Lines marked at only 1-ft intervals make visual interpolation to a 0.1 ft precision difficult, especially in heavy seas. The zero reference is the bottom crown of the mushroom anchor or sounding disk, and the marking interval begins above the connection to the sounding line. The anchor/disk shank is not marked. Marking the 0.1-ft intervals is performed using a standard 100-ft surveyor's chain. These marks must be easily read. Care must be taken to ensure that the ring/swivel and shackle connection is free and clear and that the line is under adequate tension. Types of marks used depend on the line. Marks may be seized onto the line with small cord. Seizings should penetrate the wire braids to prevent slippage. Marks may be directly crimped onto braided or solid wire using standard wire rope crimping equipment, and identified by color-coded seizing cord or seized leather flags.

d. Lead type and dimensions. A consistent lead line weight shall be either a mushroom anchor or a flat sounding disk. A contract specified weight will help ensure uniformity of contract payment, especially in areas subjected to high-suspended sediment concentrations. Lead line types or weights should not be interchanged on the same project—i.e., use the same system for pre- and post-dredge measurements.

(1) Mushroom anchor. A mushroom anchor (Figure B-3) is commonly used as a lead weight on dredging projects. These anchors come in a variety of sizes and weights. A typical mushroom anchor used on Corps projects weighs between 7 to 8 lbs. and has upwards of a 6-in. diameter crown. This type of anchor may be purchased at most marine supply outlets. The lower end of the line should be attached to the anchor ring with a freely pivoting shackle. In

some cases, a permanent bight in the line may be end-spliced around the anchor ring's eye. Any variation from this typical lead weight shall be indicated in construction contract specifications.



Figure B-3. Mushroom anchor used as lead weight.

(2) Sounding disk. A typical sounding disk is a 6-in.-diameter circular stainless steel plate. A connecting shank (4- to 5-in. length) and swivel shall be welded to the center of the plate. Four 1-in.-diameter holes shall be drilled symmetrically around the plate. Total weight, including shank and attachment swivel, shall be about 8 lb. Again, any variation from this typical design shall be indicated in construction contract specifications.

(3) In some high-turbulence areas, a heavier lead weight may be required. Lead weights in excess of 100 lb. have been used to investigate scour rates below river control structures (e.g., New Orleans District Old River Control Structure).

e. Operational procedures. Normally, measurement is made upon free-fall to apparent refusal on the bottom. Proper care shall be taken to minimize line angle from the vertical due to strong currents or tidal flow. A bicycle wheel should be employed when rapid drops are necessary such as in project depths exceeding 40 ft with strong surface or subsurface currents are present. In soft-bottomed materials, the reading should be taken at apparent refusal or within some specified time (normally 5-sec) after apparent initial penetration. In payment areas where a lead continues to fall under its own weight, it is essential that contract specifications (or subsequent agreement) indicate the elapsed time before reading. To ensure consistency and equity of payment, the same lead line and leadsman operator should be used for both pre-construction and post-construction surveys. Leads should be thrown or mechanically dropped adjacent to the tag line mark or positioning reference. If lead casts are made to port/starboard and/or forward/aft of the positioning reference, an eccentric correction must be applied. The lead line is held taut for sufficient time to visually mean any sea state variation. Observed depths are recorded to the nearest 0.1 ft, either in a surveyor's field book, on a worksheet, or directly into a

portable data-logging device, or into HYPACK. Subsequent corrections are made for river/pool stage or tidal datum. Corrections resulting from periodic calibrations are also applied.

f. Calibration. Each lead line should be calibrated at intervals of time not exceeding those listed in Table B-1. Contractors are free to request that the lead line be checked before any payment survey. Calibration should be performed by comparison of marked intervals with a steel tape. Calibration data should be recorded in a standard field survey book or on a worksheet. Differences between true and marked intervals should be computed. Measurements in the interval band should be corrected accordingly. Maximum errors should not exceed the indicated allowable values. If so, marks exceeding this value shall be reset. If a constant index error is present, the line-anchor connecting assembly should be modified to remove the error.

B-3. Sounding Pole.

a. Uses. A sounding pole is basically a level rod which uses the water surface instead of a differential leveling instrument for reference. Depths are observed relative to the water surface. If a total station is used, direct absolute elevations may be observed and reduced to the water surface datum. Standard expandable level rods are often used for sounding poles. Sounding poles, like lead lines, are useful in certain situations in which an electronic echo sounding system is not practical or accurate. For example, areas with dense bottom vegetation or irregular jetty stone may give false signals electronically and must be sounded by hand. Next to instrumental leveling, a sounding pole is perhaps the most accurate hydrographic measuring device in shallow water depths. It is especially suitable for subsurface rock and concrete placement. Its light weight is useful in fluff areas where free-fall penetration must be minimized. Its uses are generally restricted to depths not exceeding 15 to 20 ft. Figures B-4 and B-5 are illustrations of the use of a sounding pole.

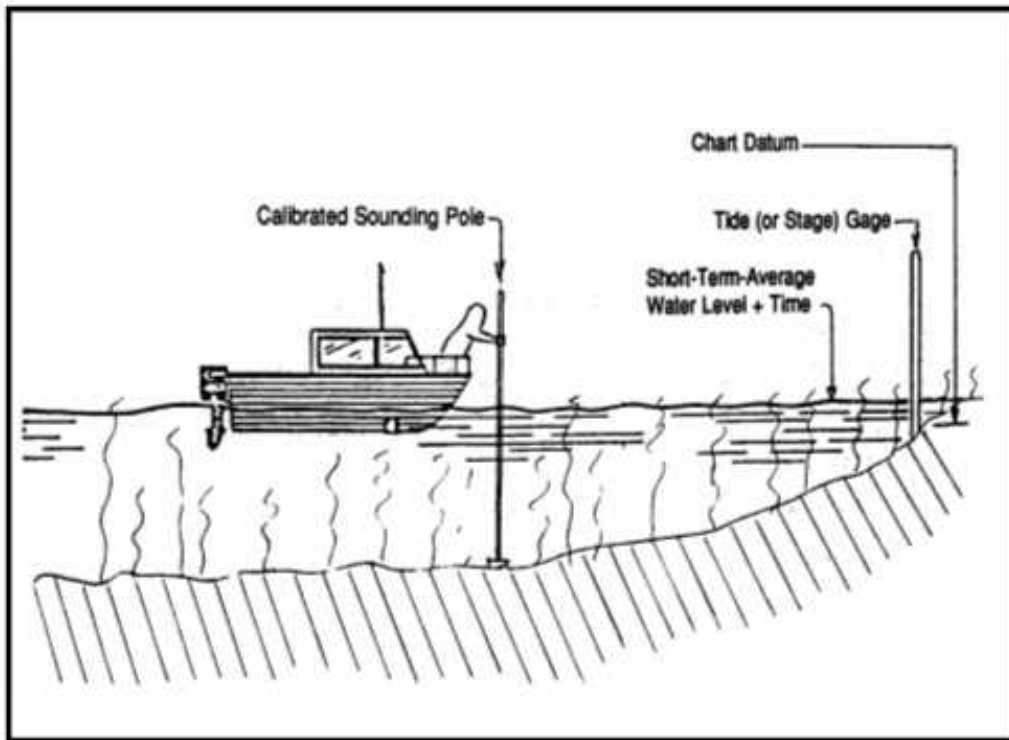

Figure B-4. Sounding pole depth measurement

b. Dimensions. Poles should generally not exceed 20 ft in length. An 8- to 15-ft-long pole is optimal for ease in handling and maintaining verticality. Wood or square tubular aluminum poles (1-in. dimension) are commonly used. Standard wooden/metallic and 25-ft expandable fiberglass level rods are also employed as sounding poles. In shallow water, a standard 2-meter GPS pole may be used. For other than subsurface rock, packed sand, concrete, or other hard bottom material depth measurement, the pole should have a 6-in.-diameter circular plate attached to the base of the pole. Overall weight of the pole (including base plate) should be less than 8 lb. In sand, 2-meter pole bases are attached to a 3-inch survey disc. As with a lead line, use of a particular pole should remain consistent throughout the duration of a contract/project. When conventional level rods or fiberglass rods are used, the base plate characteristics and overall weight should conform to a standard, such as that outlined above. Any deviation for a particular project shall be noted in the contract specifications.



Figure B-5. Sounding pole measurement from a small work boat (Jacksonville District)

c. Marking. Sounding poles are marked at 0.1-ft intervals. Rod divisions are referenced to the bottom of the base plate. Marks are usually painted and annotated in a manner identical with that used to paint and annotate conventional level rods.

d. Calibration requirements. Each sounding pole should be calibrated at periodic intervals and recorded in a standard field survey book. Pole calibration should be done by comparison with a steel tape or level rod whereby marked intervals are measured and recorded.

e. Operational procedures. In projects with hard bottom material, readings shall be taken at apparent refusal. In soft-bottomed materials, the reading shall be taken at apparent refusal or within some specified time (normally 5 seconds) after apparent initial penetration. In extreme low-density areas where the pole continues to fall under its own weight, it is essential that contract specifications (or subsequent agreement) indicate the time of reading. It is critical that no pressure be exerted in areas of highly suspended sediments. Observations are referred to the water surface and are corrected to the final datum by applying appropriate corrections, including

calibration corrections, if any. The pole must be kept as nearly vertical as possible especially in strong currents. A standard bulls-eye rod level may be attached to the pole if necessary. Depth measurements must be reduced for any horizontal eccentricities as described for lead line measurements.

B-4. Manual Depth Measurement Accuracy and Quality Control Criteria. Manual depth measurement accuracy depends on a number of factors: water depth, currents, sea state, and bottom consistency. In general, these devices are highly accurate in calm, shallow water where the device can quickly reach the bottom and depth readings can be easily interpolated from the water surface undulations. Accurate measurements require rapid estimation of the average wave action. Where feasible, direct total station elevation observations on the rod can eliminate the water surface interpolation error. However, this is usually not practical at distances beyond 500 ft from the instrument, and the water surface must be used as the reference elevation. Currents can adversely affect both lead line and sounding pole measurements, causing slope distances to be observed. In soft sediments, the reading accuracy is dependent on the ability to judge a point of refusal. This is likewise true in dense bottom vegetation or where mangrove roots are present.

a. Depth limitations. In general, the accuracy of manual depth measurement methods is limited to water depths of approximately 15 to 20 ft. Deeper measurements may be justified only in extremely calm, current-free, protected waters, with a nearby reference gage.

b. Quality control and assurance. QC techniques are basically limited to periodic calibrations of the line or rod intervals, restricting observation conditions (depth, current, sea state, etc.), and verifying tide/stage gage readings. Independent QA testing is not usually performed on manual survey methods; thus, adequate QC is essential. If distances from the reference tide/staff gage are significant, then comparisons and/or interpolations should be made from a second gage. A "significant" difference in gage observations would be water surface slope errors exceeding 50% of the required elevation accuracy--i.e., approximately + 0.1 ft for dredging and navigation surveys in less than 15 ft of water.

c. Criteria. Table B-1 describes general criteria for depth measurement observing, recording, and accuracy evaluation.

Table B-1. Recommended Manual Depth Measurement Quality Control Criteria

Recommended maximum depth:		
	Lead line	20 ft [up to 50 ft is of marginal accuracy]
	Pole	15 ft
Read/record/plot soundings to nearest		0.1 ft
Maximum currents generally NTE		4-5 kts
Reference water surface accuracy for depths < 15 ft		0.1 ft
Calibrate line/pole/rod to tape every		project [annually if rarely used]
calibrate to nearest		0.05 ft
Recommended lead line weight/type		7 to 8 lb mushroom anchor or 8 lb/6-in. diam. plate
Recommended pole/rod disc size/weight		6-in diam/8± lbs (in extremely soft material) 3.5-in survey disc on 2-mpole (sand/rock)

EM 1110-2-1003
30 Nov 13

THIS PAGE INTENTIONALLY LEFT BLANK

APPENDIX C

Contracted Survey Procedures and Cost Estimates

C-1. General. This appendix outlines the procedures used for obtaining hydrographic surveys using A-E contracting methods. It includes examples of survey scopes of work for task orders and cost estimates for hydrographic surveying services. The primary focus is on the use of task orders issued under Indefinite Delivery/Indefinite Quantity (IDIQ) contracts. Section I covers basic IDIQ contract provisions and Section II covers IDIQ Task Order procedures.

a. Procedures for developing hydrographic survey contract specifications and cost estimates are performed similarly to those for A-E design services. Similar technical discipline scheduling and production factors are used to determine the ultimate cost of a task. In addition, the Cost Estimating Center of Expertise in USACE can assist in developing dredge estimating costs in construction projects. See the web site at:
<http://www.nww.usace.army.mil/Missions/CostEngineering.aspx>

b. For detailed guidance on A-E procurement policies and practices, refer to the appropriate procurement regulations, e.g., Federal Acquisition Regulation (including DOD, DA, and USACE Supplements), EP 715-1-7 Architect-Engineer Contracting in USACE, and the ULC PROSPECT course on A-E contracting.

C-2. Background. Prior to World War II, in-house forces primarily performed design and related surveying support services in the Department of Defense. In 1939, legislation was enacted which created an expanded military construction program and authorized contracting of A-E services. Surveying and mapping services are considered a subset of A-E services. This initial contract work for military design/construction spilled over into the Corps civil works programs after the war--for similar planning, design, and surveying services. Contracting for surveying services began to expand in the late 1950's and early 1960's--especially during the space program build-up. Hydrographic surveying was one of the last Corps field survey data acquisition functions to be contracted--mostly beginning in the 1970's. Prior to the 1970's, the Corps employed well over 200 in-house hydrographic survey crews, mostly using manual tagline/leadline survey methods. In the 1960's and 1970's, outsourced survey services increased, including transfer of construction quality control functions to contractors--e.g., dredging progress payment surveys. Approximately 25% to 40% of all the Corps hydrographic work is contracted--either directly using A-E contracts or indirectly under construction contracts. The expanded use of A-E firms and dredging contractors to perform hydrographic surveying has many positive elements. These firms not only supplement any declining in-house capabilities but also provide specialized expertise in technical areas not routinely performed by the Corps. Most importantly, however, these firms represent a nationwide service base for use in a national emergency. This asset was clearly evident during the Great Flood of 1993 in the Upper Mississippi & Missouri Basin. During this high-water build up, many private hydrographic contractors were mobilized by the Corps to locate and map levee breaches and backwater flooding limits with multibeam survey equipment.

C-3. Brooks Architect-Engineer Act. In the Federal government, professional architectural, engineering, planning, and related surveying services must be procured under the Brooks Architect-Engineer Act, Public Law 92-582. The Brooks A-E Act requires the public announcement of requirements for surveying services, and selection of the most highly qualified firms based on demonstrated competence and professional qualifications. Cost or pricing is not considered during the selection process. After selection, negotiation of a fair and reasonable price for the work is conducted with the highest qualified firm. Hydrographic surveying supporting the Corps' research, planning, development, design, construction, or alteration of real property is considered to be a related or supporting architectural or engineering service, and must therefore be procured using Brooks A-E Act qualifications-based selection, not by bid price competition.

C-4. Contracting Processes and Procedures. Corps procedures for obtaining A-E services are based on a variety of Federal and DOD acquisition regulations. The following paragraphs synopsise the overall A-E process used in the Corps (see EP 715-1-7 for details on this process).

a. Types of contracts. Two types of A-E contracts are generally used for procuring hydrographic surveying services: Firm-Fixed-Price (FFP) contracts and Indefinite Delivery/Indefinite Quantity (IDIQ) contracts. FFP contracts are used for moderate to large mapping projects where the scope of work is known prior to advertisement and can be accurately defined during negotiations--typically for a large new project site. Due to variable channel shoaling and changing engineering and construction schedules (and funding), most mapping work in the Corps cannot be accurately defined in advance; thus, fixed-scope FFP contracts are rarely used, and nearly all surveying services are procured using IDIQ contracts. IDIQ contracts are commonly referred to as "Task Order Contracts" or "Indefinite Delivery Order Contracts."

b. Selection criteria. Federal and DOD regulations set the criteria for evaluating prospective surveying contractors. These criteria are listed in the public announcement in their order of importance and the selection process assigns descending weights to each item in that order.

c. Selection process. The evaluation of firms is conducted by a formally constituted Selection Board in the Corps district seeking the services. This board is made up of highly qualified professional employees having experience in architecture, engineering, surveying, etc. The board evaluates each of the firm's qualifications based on the advertised selection criteria and develops a list of at least three most highly qualified firms; from which one is selected.

d. Negotiations and award. The highest qualified firm ranked by the selection board is provided with a scope of work for the project, project information, and other related technical criteria, and is requested to submit a detailed price proposal for performing the work. In the typical case of IDIQ contracts where specific projects are not known, the scope of work simply itemizes required technical personnel (project managers, surveyors, etc.) and survey equipment requirements (e.g., single-beam, multibeam, side scan sonar, vessels, etc.). The A-E proposes rates for personnel and equipment to be used on subsequent task orders. An Independent Government Estimate (IGE)

is developed concurrent with the A-E contractor's price proposal. Once a fair and reasonable price (to the government) is negotiated, the contract is awarded. Task orders are then issued against the basic IDIQ contract using the agreed upon rates for personnel and equipment.

e. IDIQ use. IDIQ contracts typically are developed with multiple option years (e.g., three to five years). Yearly funding limits are established based on the amount of anticipated work over the term of the IDIQ contract. Typical limits range from \$1 to \$5 million per year. IDIQ contracts awarded in a District may be shared by other districts if within the scope and geographic limits of the contract. Thus, it is common for a district to issue a Task Order under an IDIQ contract from another district in the same Division.

f. IDIQ Task Orders. IDIQ contracts have only a general scope of work--e.g., "Hydrographic surveying services in the South Atlantic Division." When work arises during the term of the IDIQ contract, task orders are written for performing that specific work. Task orders are negotiated using the unit rate "Schedule" developed and negotiated in the basic IDIQ contract. From the IDIQ schedule, a hydrographic survey crew and equipment is pieced together using the various line items--adding or deducting personnel or equipment as needed for a particular project. Thus, task order negotiations are focused on the level of effort and performance period. Task orders typically have short scopes of work--a few pages. The scope is sent to a contractor who responds with a time and cost estimate, from which negotiations are initiated. The entire process--from survey need to task order award--should routinely take only one to two weeks. Under emergency conditions (e.g., flood fights, hurricanes) contractors can be issued task orders verbally by the Contracting Officer, with the scope of work simply defined as a limiting number of days for the hydrographic survey crew at the contract schedule rate.

SECTION I

IDIQ Contract Specifications and Pricing Schedules

C-5. IDIQ Contract Technical Specifications. Technical specifications for hydrographic surveying services (including general items such as types of projects, procedural requirements, and accuracy requirements) are inserted in the appropriate section of the IDIQ contract (e.g., Statement of Work--Section C). Procedural and accuracy requirements are generally referred to this engineer manual, as are any quality control criteria for the total (field-to-finish) execution of a hydrographic survey. This engineer manual should be attached to and made part of any A-E IDIQ service contract requiring hydrographic surveying. References to this manual will normally suffice for most USACE hydrographic survey IDIQ technical specifications. Variations in technical specifications are covered in the individual task order scopes of work. IDIQ technical requirements may be only generally written since detailed technical requirements will be covered in subsequent task orders. This is illustrated by the following excerpts from a basic IDIQ contract Statement of Work:

STATEMENT OF WORK SECTION C

C.1 GENERAL. THE CONTRACTOR, OPERATING AS AN INDEPENDENT CONTRACTOR AND NOT AN AGENT OF THE GOVERNMENT, SHALL PROVIDE ALL LABOR, MATERIAL, AND EQUIPMENT NECESSARY TO PERFORM THE PROFESSIONAL HYDROGRAPHIC SURVEYING *[AND MAPPING WORK] *[FROM TIME TO TIME] DURING THE PERIOD OF SERVICE AS STATED IN SECTION D, IN CONNECTION WITH PERFORMANCE OF *[_] SURVEYS *[AND THE PREPARATION OF SUCH MAPS] AS MAY BE REQUIRED FOR *[ADVANCE PLANNING,] [DESIGN,] [MAINTENANCE DREDGING,] [DETERMINING PROJECT CONDITION,] [AND CONSTRUCTION] [or other function] [ON VARIOUS PROJECTS] {specify project(s) if applicable}. THE CONTRACTOR SHALL FURNISH THE REQUIRED PERSONNEL, EQUIPMENT, INSTRUMENTS, AND TRANSPORTATION, AS NECESSARY TO ACCOMPLISH THE REQUIRED SERVICES AND FURNISH TO THE GOVERNMENT REPORTS AND OTHER DATA TOGETHER WITH SUPPORTING MATERIAL DEVELOPED DURING THE FIELD DATA ACQUISITION PROCESS. DURING THE PROSECUTION OF THE WORK, THE CONTRACTOR SHALL PROVIDE ADEQUATE PROFESSIONAL SUPERVISION AND QUALITY CONTROL TO ASSURE THE ACCURACY, QUALITY, COMPLETENESS, AND PROGRESS OF THE WORK.

SPECIFIC PROCEDURAL, TECHNICAL, AND QUALITY CONTROL REQUIREMENTS FOR HYDROGRAPHIC SURVEYING *[AND MAPPING SERVICES] TO BE PERFORMED UNDER THIS CONTRACT ARE LISTED IN THE PARAGRAPHS BELOW. UNLESS OTHERWISE INDICATED IN THIS CONTRACT *[OR IN INDIVIDUAL TASK ORDERS THERETO], EACH REQUIRED SERVICE SHALL INCLUDE FIELD-TO-FINISH EFFORT PERFORMED IN ACCORDANCE WITH THE STANDARDS AND SPECIFICATIONS IN EM 1110-2-1003.

Figure C-1. Example IDIQ Specification for Hydrographic Surveying Services

C-6. IDIQ Contract Pricing Schedules. A number of methods are used for scheduling hydrographic survey rates in an IDIQ contract. The two most common methods are (1) daily rate and (2) cost per work unit rate.

a. Daily rate. The daily rate basis is the cost for a complete hydrographic field crew (including all instrumentation, transport, travel, and overhead) over a nominal 8-hr day. (Daily crew rates are derived from hourly labor and equipment rates. Either daily and/or hourly rates may be used in the IDIQ price schedule). This method is used on the vast majority of USACE IDIQ contracts. It provides the most flexibility for IDIQ contracts, especially when individual project scopes are expected to vary widely. It is, therefore, considered a more accurate method of determining costs for individual task orders. One disadvantage is that a more detailed independent government estimate (IGE) must be developed for each task order placed against an IDIQ contract. The estimator must be thoroughly familiar with the project and survey procedures.

b. Cost per work unit rate. The cost per work unit rate basis is effectively the daily rate divided by an average production rate for a specified item of survey work. Fixed rates can then be established for items such as river sections, overbank sections, 1,000-ft offshore cross sections, linear units (miles) of sounding, square units (square miles) of sounding, per traverse mile, or any other desired unit. Labor rate contracts may be based on either pricing method. Each of these unit pricing methods have advantages and drawbacks which need to be considered prior to determining which method to use. This unit price basis is by far the simplest to administer. It is, in effect, like a GSA Schedule catalogue that allows ordering of services based on simply computed quantities. If all task order projects have relatively constant scopes (i.e., project sites, surveying requirements, and access are similar), this method should yield similar costs to those of a daily rate basis. This pricing method assumes that hydrographic surveying productivity is constant (or will average out over the long term), regardless of project site constraints, weather, and other factors. This may or may not be

a valid assumption. Unless such variations are accounted for in the price schedule, a modification to the basic contract may be required. Arriving at this rate basis requires an initial computation of the daily rate, then a determination of an average productivity rate for the field crew. Given all the project-dependent variables, development of average productivity rates is difficult and requires considerable expertise on the part of the government estimator. As a result, cost per work unit rate estimates tend to become worst-case costs that can be abnormally high in some instances. Consequently, work unit rates are rarely used in the Corps.

C-7. Preparing Independent Government Estimates for IDIQ Contracts. To develop the price schedule for IDIQ contracts, an independent government estimate (IGE) must be prepared for all technical disciplines, equipment, instrumentation, plant, travel, and other items that may be used during the term of the contract. For a FFP contract, the total of all these individual cost items is used to arrive at an overall project (contract) cost, and forms the basis for negotiating with the contractor. For an IDIQ contract, individual line items on the price schedule are estimated and negotiated with the contractor, and make up the contract schedule of prices. This IDIQ "Schedule" is then used for Task Order labor and equipment rates. The daily (or hourly) rate for a surveying crew may be estimated using the following outline. Other breakdowns may be employed to arrive at a cost per crew day, per crew hour, or per unit of work. The crew personnel size, floating plant, depth recorders, data processing systems, vehicles, etc., must be explicitly indicated in the draft contract specifications, with differences resolved during negotiations. Options to add additional specialized survey equipment (along with personnel and/or transport) must be accounted for in the estimate and unit price schedule. A contractor's cost proposal should follow the same general format used by the government's IGE, if possible. The following items are typically computed in an IGE.

- a. Direct labor. Labor or salary costs of survey technicians, including applicable overtime or other differentials necessitated by the work schedule.
- b. Overhead on direct labor.
- c. General and Administrative (G&A) overhead costs.
- d. Material costs. Include drafting supplies, field books, etc.
- e. Travel and transportation costs. Crews' travel, per diem, etc., which includes all associated costs of vehicles used to transport personnel and floating plant to/and from the job site.
- f. Other costs. Include floating plant costs and cost of survey equipment and instrumentation, such as hydrographic positioning systems and depth recorders. Instrumentation and equipment costs should be amortized down to a daily rate, based on average utilization rates, expected life, etc. Exclude any instrumentation and plant costs covered under General and Administrative (G&A) accounts--interest, maintenance contracts, etc.
- g. Profit. (For IDIQ profit is either factored in the unit prices or computed separately for each task order).

C-8. Estimating Unit Cost Rates for IDIQ Contracts. IDIQ contracts for hydrographic survey services contain price schedules for the major line items that will be used in subsequent task orders. These line items may be broken out by individual labor and equipment and/or combined for a fully equipped survey crew. The method used is dependent on local preference or use. Most USACE commands tend to compute the daily rate for a complete survey crew and make minor adjustments to that rate, depending on the unique task order scope. Plant and equipment rental rates can represent the major cost item on a hydrographic survey team, especially if the automated survey instrumentation is factored into this rate. Often the plant rental costs far exceed survey crew labor costs. Daily costs (2013) for a survey vessel in the 40- to 65-ft-long range can run between \$2,500 and \$6,000 per day. Smaller launches (18 ft to 26 ft) are far less. Labor costs (2013) for survey crew personnel usually range between \$1,500 and \$3,000 per day, depending on number of party members, complexity of equipment operated, and geographical area. Thus, a fully automated hydrographic survey team can cost between \$2,000 and \$7,000 per day to field. In preparing an IGE for an IDIQ contract, unit costs may be determined from a variety of internal or external cost sources--see EP 715-1-7.

a. Labor rates. Field crew personnel costs include direct labor, fringe benefits, and G&A overhead costs. Estimates of labor rates may be obtained from a variety of publications that detail rates by geographical area--see EP 715-1-7. Equivalent General Schedule rates may also be used in estimating labor rates if they are representative of the private sector in the locality where the work is performed.

b. Travel costs. Normally, travel costs are computed for each task order based on the current GSA rates; thus, they are not normally computed in the IDIQ schedule. Vehicle costs may be included under this category or computed under "Other Costs."

c. Other costs.

(1) Floating plant rental rates. The costs of comparable Corps-owned plant may be used in arriving at an IGE for contracted work. Commercial vessel rental rates may also be used. In the Corps, the daily plant rental and survey equipment rental rates are developed at the time of purchase and are periodically updated based on actual utilization rates as charged against projects. Plant rental rates are recomputed at least annually, or more often if utilization changes significantly. Various Plant Replacement and Improvement Program (PRIP) costs make up this expense; however, such accounting methods are not used by private contractors. In addition, vessel operator labor rates are often incorporated into the plant rental rate. Corps field survey crew labor costs are separate expense items that may be used for comparable estimates.

(2) Survey instrumentation and equipment. Survey equipment--particularly major items such as complete multibeam systems and inertial-aided GPS orientation systems--are often broken out separately in the contract price schedule. Costs for each equipment item are reduced to a daily rate based on original purchase cost, depreciation, estimated annual utilization, operation and

maintenance (O&M), and other factors. Associated costs, such as insurance, maintenance contracts, and interest, are presumed to be indirectly factored into a firm's G&A overhead account. If not, such costs must be directly added to the basic equipment depreciation rates shown. Other equally acceptable methods for developing daily costs of equipment may also be used, such as manufacturer or third-party vendor daily/monthly rental rates. Equipment utilization and life cycle estimates do represent a large variable in an IGE. Typically the IGE is subsequently revised (during negotiations), based on actual rates as determined from the contractor's proposal and from detailed cost analysis and field price support audits.

(3) The following example depicts a unit price IGE computation for a hydrographic survey crew equipped for multibeam and side scan surveys. Either the total (fully equipped) crew day rate or the rates for some selected items may be used for negotiating the final price schedule (e.g., "Schedule B") in a hydrographic survey services IDIQ contract. Similar computations would be performed for other major line items that would be included in the IDIQ contract, e.g., Project Manager, CADD Workstation Operator, Drafter, Hardware/software, etc.

(4) The example below is but one method that may be used to develop an IGE for hydrographic surveying services. Each USACE district will have unique project, survey instrumentation, survey vessel, and A-E personnel requirements, and should tailor the IGE accordingly. More detailed guidance and examples of IGE computations are found in EP 715-1-7 and in the A-E PROSPECT course manual.

(5) Note that all labor or equipment rates shown in this appendix are for illustrative purposes only.

SAMPLE IGE COMPUTATION FOR 3-MAN MULTIBEAM/SIDESCAN SURVEY CREW

NOTE: Rates and prices shown are based on ca 2000 costs and equipment rates.
Some survey equipment listed is now obsolete; thus, this example is for illustrative purposes only.

LABOR

Supervisory Survey Tech (Party Chief)	\$42,776.00/yr	
Multibeam Operator		
Overhead on Direct Labor (36%)	\$15,399.36/yr	
G&A Overhead (115%)	<u>\$49,192.40/yr</u>	
Total:	\$107,367.76/yr	\$411.57/day
Survey Technician	\$35,355/yr	
@ 151% O/H (36%+115%)	\$88,741.05	\$340.17/day
Survey Aid/Boat Operator	\$23,332/yr	
@ 151 % O/H	\$58,563.32	\$224.49/day
Total Labor Cost for 3-Man Multibeam Crew/day:		\$976.23

TRAVEL

[Optional to include this item in the IDIQ IGE – typically added to each Task order]
Per Diem (Nominal): 3 @ \$ 88/day

EM 1110-2-1003
30 Nov 13

(subject to JTR adjustment on task orders)

Total Travel Cost/day: \$264.00

PLANT, FLOATING

Survey Vessel 32-foot:
\$100,000 @ 5 yrs @ 100 d/yr \$ 200/day
Fuel, O&M, etc \$ 25/day

Total Plant Cost/day: \$ 225.00

SURVEY INSTRUMENTATION & EQUIPMENT

Echo Sounder \$30,000 @ 5 yrs @ 50 d/yr \$120/day
 POS/MV Carrier Phase Positioning Sys \$120,000 @ 4 yrs @ 100 d/yr \$300/day
 Motion sensor \$35,000 @ 5 yrs @ 100 d/yr \$ 70/day
 Multibeam System (complete) \$250,000 @ 5 yrs @ 100 d/y \$500/day
 Side Scan Sonar (complete system) \$75,000 @ 5 yrs @150 d/yr \$100/day
 Total Station (RTK), rods, etc. \$32,000 @ 5 yrs @ 120 d/yr \$ 53/day
 (rental rate: \$60/d)
 Tide Gage, Auto Telemetry (Manufacturer rental rate) \$ 22/day
 Survey Vehicle \$40,000 @ 6 yrs @ 225 d/yr plus O&M \$ 40/day
 Misc Materials (field books, survey supplies, etc) \$ 25/day

Total Instrumentation & Equipment Cost/day: \$ 1,230.00

Subtotal : \$ 2,695.23

Profit @ 10.0% \$ 269.52

Total Estimated Cost per Day -- 3 man Multibeam/Side Scan Survey Crew \$ 2,964.75

Figure C-2. Sample IGE

C-9. IDIQ Contract Price Schedule. The various personnel, plant, and equipment cost estimates like those shown in the sample IGE above are used as a basis for negotiating fees for individual line items in the basic IDIQ contract. During negotiations with the A-E contractor, individual components of the IGE and the contractor's price proposal may be compared and discussed. Differences would be resolved in order to arrive at a fair and reasonable price for each line item. Computations similar to those shown in the above example would be performed for auxiliary home office direct support functions (e.g., drafter, CADD operator, etc.). The contract may also schedule unit prices based on variable crew sizes and/or equipment and may include non-hydrographic survey functions such as control surveys. An example of a negotiated IDIQ price schedule (i.e., Section B - Supplies or Services and Prices/Costs) is shown below. As indicated previously, each Corps district has its unique requirements and therefore line items used in schedules will vary considerably. The basic IDIQ contract specifications would contain the personnel and equipment requirements for each line item.

ITEM	DESCRIPTION	UNIT OF MEASURE	UNIT PRICE
1001	4-Man Topographic Survey Party	CD	\$ 885.00
1002	5-Man Hydro Survey Party w/boat	CD	\$1,382.00
1002a	4-Man Hydro Survey Party w/boat	CD	\$1,200.00

1002b	3-Man Hydro Survey Party w/boat	CD	\$1,000.00
1002c	2-Man Hydro Survey Party w/boat	CD	\$ 784.00
1003	Survey Aid	CD	\$ 144.00
1004	Per Diem (Florida)	MD	\$ 78.00
1005	Project Manager	MD	\$ 335.00
1006a	Project Manager (Per Diem-Florida)	MD	\$ 78.00
1007	CADD Operator/Draftsman	MD	\$ 300.00
1008	Computer (Person)	MD	\$ 238.00
1011	Establish Control Monument	EA	\$ 25.00
1012b	Extra Vehicle	DY	\$ 100.00
1013	Air Boat (Florida w/operator)	DY	\$ 130.00
1014	Marsh Buggy (Florida w/operator)	DY	\$ 160.00
1016	Side Scan w/Operator	HR	\$ 120.00
1018	Multibeam w/Operator	HR	\$ 130.00
1019	Magnetometer w/Operator	HR	\$ 120.00

NOTES:

Abbreviations: CD = Calendar Day MD = Man Day DY = Day EA = Each HR = Hour
Prices include overhead and profit.

NOTE: the above items and unit prices were developed ca 1995 and are shown for illustrative purposes only. They are not based on current (2013) survey procedures or equipment.

Figure C-3. Contract schedule B-hydrographic surveying services indefinite delivery/indefinite quantity contract

EM 1110-2-1003

30 Nov 13

LABOR CLASSIFICATION	TOTAL DAILY RATE*
Hydrographic Survey Expert (Court Testimony)	\$1,500.00
Senior Project Manager (RLS)	\$800.00
Project Manager/ Senior Hydrographer (Field-Office)	\$750.00
Hydrographic Party Chief (Field)	\$600.00
Hydrographic Survey Technician (Field)	\$400.00
Instrument Person/Survey Technician (Field)	\$300.00
Tideperson/Rodperson/Survey Assistant (Field)	\$250.00
Geophysicist/Analyst (Field)	\$1,200.00
Senior CADD Operator/Survey Computer	\$500.00
Digitizer/ Draftsperson	\$300.00
Word Processor (Typist)	\$250.00
 Per Diem (per person)	 \$200.00

* Labor rates include a total Overhead of 150.00% and include a Profit of 10%.

DIRECT COST ITEMS:	TOTAL DAILY RATE
--------------------	------------------

[Floating Plant: NOTE: Vessel rates do not include survey equipment or instruments]

28-ft Survey Vessel with Trailer (no operator)	\$600.00
50-ft Survey Vessel (w/boat operators)	\$3,000.00
100-ft Survey Vessel (w/boat operators)	\$8,000.00
210-ft Geophysical exploration vessel (w/boat operators)	\$35,000.00
Air Boat (w/operator)	\$130.00
Marsh Buggy (w/operator)	\$150.00
Skiff, alum, 12-ft (no operator)	\$50.00

[Hydrographic Survey Equipment]

Hydrographic Computer Data Acquisition System-HYPACK MAX (Single or Multibeam Data Acquisition & Processing)	\$155.00
Onboard plotter for survey computer system	\$100.00
DGPS Code Phase Hydrographic Positioning System	\$100.00
GPS Carrier Phase (RTK) Topo/Hydro Positioning System	\$350.00
200 kHz Fathometer with digitizer (single beam)	\$70.00
Multi-beam Sweep System (200 kHz); complete system	\$1,000.00
Dual Frequency Fathometer with digitizer	\$150.00
Side Scan w/Operator	\$950.00
Magnetometer w/Operator	\$950.00
Sound velocity profiler	\$50.00
Inertial Motion Compensation Device (Heave/pitch/roll)	\$200.00
Gyro Compass	\$150.00
POS/MV GPS Attitude & Orientation System	\$200.00
Automatic Water Level Recorder & Telemeter	\$60.00

[Land Surveying Equipment]

Total Station Surveying & Data Logging System; complete, w/tripods	\$150.00
Level, Automatic w/rods, tripods	\$50.00
Theodolite, Wild T-3; complete with tripods, targets, tribrachs	\$30.00
Theodolite, Astronomic, Wild T-4	\$80.00
Transit, Engineers, w/tripod	\$20.00

[Transportation]

Survey Vehicle (4X4) with towing capability	\$75.00
Survey Vehicle, Standard Van	\$50.00
ATV, dune/beach buggy	\$50.00

ALL OTHER DIRECT COSTS WILL BE NEGOTIATED ON A TASK ORDER BASIS.

Figure C-4. Contract schedule B-hydrographic surveying services indefinite delivery/indefinite quantity contract
SECTION II

Task Order Time and Cost Estimates

C-10. Task Order Requests for Proposal. A scope of work for a specific project is provided to the A-E contractor, requesting a proposed time and cost to perform the work. The task order scope should clearly define the work along with specific deliverable requirements. Examples of task order Requests for Proposal are provided at the end of this Section. Upon receipt of the contractor's proposal, the USACE and contractor negotiate a fixed price for the task order.

C-11. Task Order Time and Cost Estimates. Once unit prices have been negotiated and established in the basic IDIQ contract schedule, as illustrated in Section I, each IDIQ task order is negotiated primarily for effort, i.e., time. The process for estimating the time to perform any particular survey function in a given project is highly dependent on the knowledge and personal field experience of the government and contractor estimators. The negotiated fee on a task order is then a straight mathematical procedure of multiplying the agreed-upon effort against the established unit prices in the IDIQ Price Schedule, plus an allowance for profit if not included in the unit rates. If a preliminary site investigation is scheduled for this project, any such adjustments should be investigated and resolved prior to negotiating subsequent task orders for the various phases of the work, to the maximum extent possible. As such, the negotiated costs for the subsequent work phases would be considered fixed price agreements. Any later adjustments to these agreed to prices would be issued in the form of modifications/amendments to task orders (i.e., change orders), and would have to be justified as significant, unforeseen changes in the scope. The A-E contractor would be expected to immediately notify the contracting officer (KO) or Contracting Officer's Technical Representative of the need for cost adjustments.

a. Factors to consider in estimating task order field survey effort. The following items are typically involved in developing time and cost estimates for an IDIQ Task Order for a specific hydrographic survey project.

- Mob/Demob
Travel time from A-E home office.
Set up time at job site.
- Preliminary work
Set tide staffs/gages ... leveling, set BMs.
Set control points ... traverses, RTK, etc.
- Survey project area
Perform QC calibrations.

Single-beam, multibeam, side-scan, other. Perform QA performance tests.

- Field data processing, editing, plotting, QA assessment.
- Potential resurveys ... dredging projects.
- Allowances ... weather, breakdowns, etc.

b. Task Order IGE computation. A task order IGE simply requires an estimate of the time required to perform the field survey and office data processing for a project. Given the time estimate, the total cost is determined using the IDIQ scheduled rates. Estimating field survey effort is described in other chapters of this Engineer Manual.

c. Example IGE. The example below illustrates a time and cost IGE for a multibeam survey task order under an IDIQ contract using the unit prices taken from the Price Schedule established in the IDIQ contract. The estimate for field survey effort (seven crew days) is not shown. This was based on the required miles of survey, vessel speed, etc. specific to the project—see examples of these computations in Chapter 2.

Estimated field survey time ... 7 crew days
 Mob/demob from home office ... 4 crew days.
 Set tide staff/gage ... 1 crew day.
 Field data processing, editing, QA ... 1 crew day.
 (Crew day rate includes plant, personnel, equipment, and per diem)

Office review, QA, CADD export, plotting ... 2 man days.
 Office professional supervision (PLS review) ... 1 man day.

Task Order IGE:

(\$3,100 crew day rate includes plant, personnel, equipment, and per diem)

Total Crew Days:	13 days * \$3,100/day =	\$40,300
Office CADD	2 days * \$300/day =	\$ 600
Project Manager	1 day * \$335/day =	\$ 335

TOTAL ESTIMATED TASK ORDER COST (IGE)	<u>\$41,235</u>
---------------------------------------	-----------------

Table C-1 Time and Cost IGE under IDIQ

d. Note that this is a simplified example. Other line items from the IDIQ Price Schedule might have been included in task order estimate. The contractor's proposal for this Task Order would follow a similar process. Subsequent Task Order negotiations would primarily focus on significant differences in time estimates for the various phases of the work. This assumes the scope

of work is clearly defined in the Task Order Request for Proposal. Uncertain scopes would have to be resolved during negotiations and the IGE amended accordingly.

C-12. Task Order IGE Time Estimates. The USACE IGE time estimate must be based on solid facts regarding the performance capabilities of the contractor performing the work and the project site conditions. This would include reasonable allowances for unforeseen conditions. The IGE estimator must also be familiar with the survey equipment, calibration requirements, and production rates of that equipment. In cases where the A-E is unfamiliar with the project site conditions, the contractor's proposal may assume "worst-case" conditions. For example, in the above estimate, the A-E may propose 11 crew days of field survey time vice the 7 crew day IGE. Thus, during task order negotiations, the USACE estimator's experience is critical in resolving such a difference.

C-13. Labor Hour Task Orders for Construction Support Surveying Services. Fixed-price task orders under IDIQ contracts are effectively used to provide a substantial amount of surveying and mapping services in USACE. However, fixed-price task orders are not usually appropriate for quality assurance and payment surveys of ongoing dredging and construction projects since the duration of the survey work is not within the control of the survey contractor. The surveyor contractor's progress is dependent on the progress of the dredging or construction contractor, which in turn, depends on weather, equipment malfunctions, unforeseen site conditions, material availability, labor problems, and many other factors. In such cases, a labor-hour task order is a very useful contracting mechanism. Labor-hour task orders are appropriate when the uncertainties involved in contract performance do not permit costs to be anticipated with sufficient accuracy or confidence to use a fixed-price task order. The contractor is required to apply its best efforts, but is not obligated to complete the assigned work within the contract ceiling price. Hence, a higher level of surveillance is required by the Government to ensure the contractor is performing as efficiently as possible. No special approvals are required to use labor-hour task orders, but the contracting officer must execute a determination and findings for the contract file explaining why a fixed-price order was not suitable. There is no true negotiation, but rather an agreement on a realistic ceiling price considering the most likely conditions. All hourly costs for personnel and equipment (including overhead and profit) are already established in the basic IDIQ contract. The Government buys a certain amount of effort and has considerable control over how that effort is expended toward completion of the specified task. The Government can direct the contractor to start, pause, and stop work, within reasonable limitations. However, the Government bears the cost for disruptions in work. A labor-hour task order has the flexibility to follow the progress of the dredging or construction, without unfairly holding the survey contractor to a fixed price. The most cost-effective situation is where there is more than one project in the same area that can be surveyed using one task order. If there is a delay on one project, the survey crew can relocate to another project and resume work with minimal lost time. The following is an example of a Labor Hour task order scope:

Furnish all personnel, plant, equipment, transportation and materials necessary to perform, process and deliver the survey data described herein for dredging payment surveys in the following work areas in accordance with the general instructions and conditions set forth in Contract DACWXX-XX-D-XXXX:

- [List projects or work areas. Attach marked-up maps if needed. Describe work.]

Since it is not possible to accurately estimate the extent or duration of this work, this order will be issued on an estimated, not-to-exceed basis. The estimated quantities and ceiling price in accordance with the established contract rate schedule are as follows:

3-Person survey crew @ \$[____]/hour x [____] hours:	\$ _____
Project manager @ \$[____]/hour x [____] hours:	\$ _____
Ceiling price:	\$ _____

It is estimated that this work will begin about [__(date)__] and be completed about [__(date)__]. The contracting officer's representative (COR) at the [_____] Project Office will advise the contractor at least [____] hours in advance of when work must begin. The contractor may be directed to stop work at any time due to circumstances beyond the Government's control. If work is stopped at a work area, the contractor may be directed to relocate and start (or continue) work at one of the other work areas covered by this order, or to demobilize and return to the contractor's office. The contractor will be compensated at the hourly contract crew rate while stopped, relocating to another work area, demobilizing, or remobilizing (if required). There will be no compensation while the contractor is demobilized. The COR will advise the contractor at least [____] hours in advance of when the contractor must remobilize and resume work.

The contractor will prosecute the work diligently and efficiently under the general direction and oversight of the COR. The contractor will provide a daily report, describing the work performed and hours worked, to the COR for certification. The daily reports will be used by the contractor to prepare monthly payment vouchers. With each monthly payment voucher, the contractor will estimate monthly and total earnings in the succeeding month, expressed both as total dollars and a percentage of the ceiling price.

The contractor will immediately notify the COR in writing when total estimated earnings reach 85 percent of the ceiling price. Also, if at any time the contractor projects that the total estimated earnings to complete the work will exceed the ceiling price, the contractor will promptly notify the COR and give a revised estimated total price with supporting reasons and documentation. The contracting officer will increase the ceiling price in writing if warranted or limit the work so as to remain within the current ceiling price. Exceeding the ceiling price is at the contractor's own risk.

[Insert technical requirements and deliverables.]

Figure C-5. Labor hour task order

C-14. Contract Quality Control and Quality Assurance. Under the Corps professional contracting system, contractors are responsible for performing all quality control (QC) activities associated with their work. The Corps is responsible for quality assurance (QA) oversight of the contractor's QC actions. Therefore, Corps QA or testing functions should be focused on whether the contractor meets the required performance specification (e.g., depth accuracy), and not the intermediate surveying or compilation steps performed by the contractor. As a result, for surveys procured using the Brooks A-E Act qualifications-based selection method, Corps representatives are not stationed aboard contractor survey vessels to observe work in progress (i.e., perform QC activities)--the contractor was selected as being technically qualified to perform the work; including all QC

associated with it. Corps-performed field testing of a contractor's work is an optional QA requirement, and should be performed only when technically and economically justified. Such Corps testing of a contractor's hydrographic survey data submittal rarely occurs in practice.

SAMPLE TASK ORDER REQUEST FOR PROPOSAL

Engineering Division
Design Branch

Subject: Contract No. DACW17-96-D-0017

EMC Inc.
101 West Market Street
Greenwood, Mississippi 38930-4431

Gentlemen:

Enclosed are marked drawings depicting the scope of work for the following project:

Canaveral Sand Bypass Phase II
Pre and Post Construction Survey
Canaveral, Florida (Survey No. 97-096)

General Scope. Furnish all personnel, plant, equipment, transportation, and materials necessary to perform and deliver the survey data required hereinafter in accordance with the instructions and conditions set forth in Contract No. DACW17-96-D-0017. Services not specifically described herein are nevertheless a firm requirement if they can be identified as an item, or items, commonly a part of professional grade work of a comparative nature. All work shall be accomplished in accordance with the manuals and TM's specified in your contract.

- Your attention is directed to the Site Investigation and Conditions Affecting the Work clause of your contract. After we have reached agreement on a price and time for performance of this work, neither the negotiated price nor the time for performance will be changed as a consequence of conditions at the site except in accordance with the clause. Costs associated with the site investigation are considered overhead costs which are reimbursed in the overhead rates included in your contract. Additional reimbursement will not be made.

a. Field Survey. Pre and After construction hydrographic and topographic beach survey data shall be collected for the borrow area and beach fill area. Enclosure 1 is the contract plans. Enclosure 2 is the control monument descriptions. Enclosure 3 is the technical requirements for the surveys.

The Contractor shall furnish one 4-Man hydrographic survey party. The task order shall be issued based on the estimated-not fixed-number of field crew days, project manager, CADD days, and computation days. When the assignment is completed the task order shall be adjusted to reflect the total cost. To certify the hours worked and progress, a daily report shall be furnished to Design Branch from the field party employed. Weekly submittal is acceptable. The Contractor's work hours and days may have to be adjusted to coincide with the Corps of Engineers request. The Contractor shall indicate on the daily report the survey party hours worked on that day. The Contractor shall be notified 24 hours in advance of any work assignment.

The points of contact are, Mr. Hank Rimmer, at 904-232-1606, and Mr. James Lanier at 407-783-8407. Any instruction given to the survey crew by the Atlantic Coast Area Office shall be coordinated with Mr. Rimmer before commencing.

b. Data processing. The Contractor shall make the necessary computations to verify the accuracy of all measurements and apply the proper theory of location in accordance with the law or precedent and publish the results of the survey.

c. CADD. The hydrographic and topographic features shall be translated or digital capture into Intergraph IGDS 3D design files according to the specifications furnished. The survey data (cover and section view sheets) shall be provided in Intergraph Microstation (PC or 32) Version 4.0 or higher, AT&T System V Unix, CLIX R3.1 Vr. 6.3.2 format as shown in the letter dated 30 September 1992.

Surveying shall be in strict compliance with the Technical Requirements for Surveying Mapping and Photogrammetric services manual and the Minimum Technical Standards set by the Florida Board of Land Surveyors and Mappers.

The completion date for this assignment is 90 days after the Notice to Proceed is signed by the Contracting Officer.

All material shall be returned to Design Branch upon completion of this assignment.

EM 1110-2-1003

30 Nov 13

You must notify the Contracting Officer immediately when the work effort is 85% of the not to exceed amount. Contact Design Branch at 904-232-1613 for questions or assistance with your proposal.

You are required to review these instructions and make an estimate in writing of the cost and number of days to complete the work. Please mark your estimate to the attention of Chief, Survey Section.

This is not an order to proceed with the work. The Contracting Officer will issue this at a later date.

Figure C-6. Sample Task Order Request for Proposal

Example Task Order Scope of Work--Sand Bypass Project

CANAVERAL SAND BYPASS PHASE II PROJECT
PRE AND POST HYDROGRAPHIC AND TOPOGRAPHIC
BEACH CONSTRUCTION SURVEY
CANAVERAL, FLORIDA
SURVEY No.97-096

1. LOCATION OF WORK: The project is located at Canaveral, Florida.

2. SCOPE OF WORK:

2a. The services to be rendered by the Contractor include obtaining topographic and hydrographic beach survey data (x, y, z) for the borrow area from CCAFS-38 TO CCAFS-29, for the beach fill area from R-7-T to R-14 and CADD files as shown on Enclosure 1, contract plans and specifications.

2b. The services to be rendered by the contractor include all the work described below. Details not specifically described in these instructions are nevertheless a firm requirement if they can be identified as an item, or items, commonly a part of professional grade work of a comparative nature.

2c. The contractor shall furnish all necessary materials, labor, supervision, equipment, and transportation necessary to execute and complete all work required by these specifications.

2d. The Corps of Engineers, Design Branch shall be contacted the same day that the Contractor plans to commence the work. The points of contact are, Mr. Hank Rimmer, (CORPS OF ENGINEERS DISTRICT OFFICE) at 904-232-1606, and Mr. James Lanier (ATLANTIC COAST AREA OFFICE) at 407-783-8407. Any instruction given to the survey crew by the Atlantic Coast Area Office shall be coordinated with the Mr. Rimmer before commencing. A meeting with the Atlantic Coast Area Office, Mr. Lanier shall be arranged before commencing the surveys to establish the priority for the surveys.

2e. Rights-of-Entry must be obtained verbally and recorded in the field book before entering on the private property. Enter in the field book the name and address of the property owner contacted for rights-of-entry.

2f. COMPLIANCE: Surveying shall be in strict compliance with Engineering and Design Standards and Specifications for Surveys, Maps, Engineering Drawings, and Related Spatial Data Products and the Minimum Technical Standards set by the Florida Board of Professional Surveyors and Mappers.

2g. All digital data shall be submitted on CD ROM's.

3. FIELD SURVEY EFFORT: Topographic and hydrographic beach survey data shall be obtained for the borrow area from CCAFS-38 TO CCAFS-29, for the beach fill area from R-7-T to R-14 and CADD files as shown on Enclosure 1, contract plans and specifications. Enclosure 2 is the contract plans and specifications. Enclosure 3 is the control monument descriptions. Enclosure 4 is the Technical Requirements.

3a. CONTROL: The Horizontal datum shall be NAD 1927 and the vertical datum shall be N.G.V.D. of 1929. All control surveys shall be Third Order, Class II accuracy.

3a1. The basic control network can be accomplished using precise differential carrier-phase Global Positioning System (GPS). Differential GPS baseline vector observations shall be made in strict accordance with the criteria contained in the engineering manual EM-1110-1-1003 and with the Geometric Geodetic Accuracy Standards And Specifications For Using GPS Relative Positioning Techniques by Federal Geodetic Control Committee, version 5.0.

3a2. Network design, station and baseline occupation requirements, for static and kinematic surveys, satellite observation time per baseline, baseline redundancies, and connection requirements to existing networks, shall follow the criteria given in the above said engineering manual. A field observation log sheet shall be completed at each setup in the field.

3a3. GPS derived elevation data shall be supplied in reference to the above said datum. Existing benchmark data and stations shall be used in tandem in a minimally constrained adjustment program to model the geoid. All supporting data used in vertical adjustment shall be submitted.

3a4. Existing Corps of Engineers project control shall be utilized for establishing horizontal and vertical control. No control monuments shall be utilized that are not included in the control network shown in the contract plans. All established or recovered control shall be fully described and entered in a FIELD BOOK, in accordance with the Technical Requirements of this contract. Recover or establish horizontal and vertical control monuments at each profile line. The designations for new control monuments will be furnished when needed. All horizontal and vertical control shall be verified before using.

3a5. All horizontal and vertical control (double run forward and back) established shall be a closed traverse or level loop no spur lines, with third order accuracy. All horizontal and vertical control along with baseline layouts, sketches, and pertinent data shall be entered in field books.

3a6. All monuments, survey markers, etc., recovered shall be noted on the copies of control descriptions. Control points established or recovered with no description or out-of-date (5 Years old) description shall be described with sketches for future recovery use.

3a7. All original field notes shall be kept in standard pocket size field books and shall become the property of the Government. The first four pages of the field books shall be reserved for indexing and the binding outside edge shall be free of all marking. Design Branch will issue field book numbers upon submittal of field books for checking.

3b. TIDE STAFF: The survey data shall be collect on MLW datum which is 1.9 below N.G.V.D. located in vicinity of "CABLE SOUTH PORT" monument.

3c. BORROW AREA: Collect survey data (X, Y, & Z) for profile lines CCAFS-38 thru CCAFS-29. The profile lines shall start at the monuments (range 0) and extend seaward to range 1600 with data points at 25 foot range intervals and all breaks and 12.5 foot intervals in the water. The profile lines shall be ran on the azimuth shown in Enclosure 1. Establish a survey stake at 3.5 foot MLW elevation on each profile line. The survey stake shall be labeled with 3.5 MLW.

3d. BEACH FILL AREA:

3d1. BASELINE: Establish a baseline landside of the monuments with line of sight from R-7-T to R-14. The baseline shall be establish between elevation 9.5 MLW and the monuments. Establish POT's along the baseline at 100 foot intervals.

3d2. PROFILE LINES: Collect survey data (X, Y, & Z) on 100 intervals with data points at 25 foot range intervals and all breaks for the land portions and 12.5 for the water portions, from the monuments (range 0) to range 1000 seaward. Establish a survey stake at 9.5 foot MLW elevation for each profile line. The survey stake shall be labeled with 9.5 MLW.

3e. BREAKLINE: Breaklines shall be located for all natural or man-made features as needed. The breaklines shall be located with X, Y, and Z and identified.

3f. DATA COLLECTION (RTK or TOTAL STATION): Data collection will be allowed for data points only, showing all instrument positions, calibration, backsites and closing readings in the field book. If RTK is utilized Q1 and Q2 files shall be furnished. Before using RTK, one session shall be performed around the expected survey area. After observation of the primary control (four monuments; one on each corner of the work area) the geoid model shall be prepared utilizing the four occupied monuments data.

4. DATA PROCESSING: The Contractor shall make the necessary computations to verify the accuracy of all measurements and apply the proper theory of location in accordance with the law or precedent and publish the results of the survey. Compute and tabulate the horizontal and vertical positions on all work performed. Review and edit all field data for discrepancies before plotting the final drawings.

4a. Furnish X, Y, Z, and descriptor ASCII file for each profile line and one X, Y, Z, and descriptor ASCII file with all profile lines included for each area.

5. CADD: The topographic and hydrographic features shall be translated or digital capture into Intergraph IGDS 3D design files according to the specifications furnished. The survey data (cover, control, site plan, plan sheets, and section drawings) shall be provided in Intergraph Microstation (PC or 32) Version 4.0 or higher, AT&T System V Unix, CLIX R3.1 Vr. 6.3.2 format as shown in the letter dated 30 September 1992. All CADD files shall be the same as shown in Enclosure 1.

EM 1110-2-1003

30 Nov 13

5a. GLOBAL ORIGIN: The IGDS 3-D design file shall be prepared with a global origin of 0, 0, 2147483.65, Design file master units: FT., Sub units: 1,000, and positional units: 1. The file name shall be the survey number prefixed with an "Y", i.e. Y049sh1.DGN. All reference files name shall commence with the Y049**.DGN also.

5b. DIGITAL TERRAIN MODEL (DTM) DATA: The Contractor shall develop and deliver a surface model of each survey area using Intergraph compatible Digital Terrain Modeling software and the model file shall have the .dtm extension. The digital terrain model shall be developed from the collected data. Breaklines should include ridges, drainage, road edges, surface water boundaries, and other linear features implying a change in slope. The surface model shall be of adequate density and quality to produce a one-foot contour interval derived from the original DTM (Digital Terrain Model) file. The contour data shall be incorporated as a reference file into the final data set (DGN file). All data used to develop the DTM shall be delivered in Intergraph 3-D design files.

5b1. CONTOURS: The contours shall be developed in the digital terrain model (DTM). The contours shall be provided in one or more master (scale 1" = 200') DGN files, attached as a reference file to all sheet files utilizing clip bounds methods. Each contour shall be drawn sharp and clear as a continuous solid line, dashed contours are not acceptable. Every index contour shall be accentuated as a heavier line than the intermediate contour line and shall be annotated according to its actual elevation above MLW. Labeling or numbering of contours shall be placed on top of the contour line, so that the elevation is readily discernible, do not break contours. Labeling of intermediate contours may be required in areas of low relief.

5c. MASTER DGN FILES:

5c1. The survey data (DTM data points) points shall be provided in one or more master DGN file (scale 1" = 200'), attached as a reference file to all sheet files utilizing the clip bounds methods.

5c2. The contours shall be provided in one or more master DGN file (scale 1" = 200'), attached as a reference file to all sheet files utilizing the clip bounds methods. "DO NOT PLOT THE CONTOURS".

5c3. The breaklines shall be provided in one or more master DGN file (scale 1" = 200'), attached as a reference file to all sheet files utilizing the clip bounds methods, "DO NOT PLOT THE BREAKLINES".

5c4. The control points shall be provided in one or more master DGN file (scale 1" = 200'), attached as a reference file to all sheet files utilizing the clip bounds methods.

5c5. The baseline shall be provided in one or more master DGN file (scale 1" = 200'), attached as a reference file to all sheet files utilizing the clip bounds methods.

5d. COVER AND CONTROL SHEET: The first sheet shall be a cover sheet showing the control sketch, survey control tabulation, sheet layout or index, legend, project location map, survey notes, north arrow, graphic scale, grid ticks, large signature title block. Tabulate, plot, and list the control used for the survey on the final drawings.

5e. PLAN SHEETS: The plan sheets shall be prepared to a scale of 1" = 200', in the Corps of Engineers format (reference letter and instruction dated September 30, 1992) showing notes, title block, grid, north arrow, graphic scale, legend, sheet index, and D. O. File Number. Sheets shall be oriented with north to the top and designed to utilize the least number of sheets. The extreme right 7 inches of the sheet shall be left blank for notes, legends, etc. The first (cover) sheet shall have large signature block. The second sheet and all sheets following shall be a continuation sheet and shall have a minimum of two notes, note 1: See Drawing number 1 for notes, note 2: Refer to Survey No. 97-096. PAPER PLOTS ONLY".

6. MAP CONTENT:

6a. COORDINATE GRID (NAD 27): Grid ticks (English) of the applicable State Plane Coordinate System shall be properly annotated at the top, bottom and both sides of each sheet. Spacing of the grid ticks shall be five (5) inches apart.

6b. CONTROL: All horizontal and vertical ground control monuments shall be shown on the maps in plan and tabulated.

6c. TOPOGRAPHY: The map shall contain all representable and specified topographic features which are visible or identifiable.

6d. SPOT ELEVATIONS: Spot elevations shall be shown on the maps in proper position. In areas where the contours are more than 3 inches apart at map scale, spot elevations shall be shown. The horizontal distance between the contours and such spot elevations or between the spot elevations shall not exceed two (2) inches at scale of delivered maps.

6e. CONTOURS: The contours shall be developed in the digital terrain model (DTM). Each contour shall be drawn sharp and clear as a continuous solid line, dashed contours are not acceptable. Every index contour shall be accentuated as a heavier line than the intermediate and shall be annotated according to its actual elevation. Whenever index contours are closer than one-quarter (1/4) inch, and the ground slope is uniform, the intermediate shall be omitted. Labeling or numbering of contours shall be placed on top of the

contour line, so that the elevation is readily discernible, do not break contours. Labeling of intermediate contours may be required in areas of low relief.

6f. MAP EDIT: All names, labels, notes, and map information shall be checked for accuracy and completeness. All buildings, roads and man made features shall be labeled with the type of construction, purpose and name. All residences shall be labeled with the type of construction.

6g. SHEET INDEX AND LEGEND: On plan drawings a small scale sheet index shall be shown on each sheet of the series; highlighting the sheets in the standard manner. Planimetric and topographic feature legends shall be shown on each sheet. Contractor logo shall be shown on each drawing.

6h. MAP ACCURACY: All mapping shall conform to the national map accuracy standards except that no dashed contours will be accepted.

7. OFFICE REVIEW AND COMPUTATIONS: The Contractor shall make the necessary computations to verify the correctness of all measurements and apply the proper theory of location in accordance with the law or precedent and publish the results of the survey.

8. DELIVERIES: On completion, all data required shall be delivered or mailed to Design Branch, Survey Section at the address shown in contract, and shall be accompanied by a properly numbered, dated and signed letter or shipping form, in duplicate, listing the materials being transmitted. All costs of deliveries shall be borne by the Contractor. Items to be delivered include, but are not limited to the following:

- 8a. GPS network plan.
- 8b. GPS raw data along with field observation log sheets filled out in field with all information and sketches.
- 8c. Computation files with Horizontal and Vertical abstracts along with any Q1 and Q2 files.
- 8d. Horizontal and Vertical Field Books.
- 8e. Furnish X, Y, Z, and descriptor ASCII file for each profile line and one merged with all data collected for each area.
- 8f. DTM File
- 8g. DGN files to a scale of 1" = 200.
- 8h. Advance paper plots of all plan sheets, cover sheet and control sheets for approval.

Figure C-7. Sample Task Order Scope of Work

Example Task Order Scope of Work--River Sections

**PROPOSED TASK ORDER NO. 26
CONTINENTAL ENGINEERING, INC.
DACW66-97-D-0053**

Scope of Work
1999 Mississippi River General Hydro Surveys
7 January 1999

1. General Scope The contractor shall perform General Hydrographic Surveys on the Mississippi River within the reaches described in the enclosures. The surveys shall include the development of digital maps reduced to the low water reference plane, color coded elevations (polyfill shapes vs triangles), checked for correctness, hard copy of each survey including the raster image, and a format developed to be directly inserted into the Regional Engineering Environmental Geographical Information System (REEGIS).

2. Survey Requirements and Specifications.

a. Miscellaneous. See Miscellaneous Survey and Specifications (MSRS), dated 4 March 1993, paragraphs 1 through 8 for A-E responsibilities in regard to Quality Assurance, Submission of Pay Estimates, Safety, Project Progress Reports, Damages, Coordination of Work, Datums, and Survey Field Notes.

b. Right of Entry. Verify right of entry with the QARs. See paragraph 9.b., MSRS dated March 1993.

c. Survey Limits. The limits for the surveys shall be the reaches as described in Encl. 1. The surveys shall extend from bank to bank at 1056-ft intervals unless otherwise required in the limit enclosure. Additional ranges shall be sounded upstream and downstream as near as safety considerations will allow to existing dikes. The ranges obtained near dikes should not be from bank to bank, but should extend a minimum of 200 feet beyond the riverward end of the dike. The data shall be obtained within the reaches described and sheets not split. Existing Horizontal Control. Adequate horizontal control exists within a reasonable distance of the survey limits to perform this project. The control consists of monuments used for all river work within the Memphis District. Horizontal control shall be supplied to the respective hydrographic survey party chiefs at the Memphis District Office prior to the start of the surveys.

d. New Baseline Control. No new baseline control shall be required for this project.

f. Horizontal Computations. All horizontal data developed for this project shall be computed on the North American Datum of 1983 (NAD 83) using Universal Transverse Mercator (UTM) Zone 15 or 16 plane coordinates in U.S. Survey Feet. See MSRS, paragraph 12 for other requirements. Azimuth orientation shall be from zero North.

g. Existing Vertical Control. Adequate vertical control exists within a reasonable distance of the survey limits to perform this project within the accuracy specified. Recovery of existing vertical control shall be documented as described in MSRS paragraphs 13.a., 13.b., 13.c., and 13.d.

g. New Vertical Control. No new vertical control shall be required for this project.

h. Monumentation. No new monumentation is required under this Scope of Work.

i. Digital Map. A digital map in a separate IGDS file for each hydrographic sheet shall be required at a scale of 1:10,000 with a five-foot contour interval. An ASCII file shall be provided that includes all hydrographic data collected and edited for erroneous soundings and positions. Soundings shall be collected at intervals no greater than 50 feet. A second ASCII file shall also be provided which contains an x,y,and z coordinate at least every 100 feet along each range.

A Microstation design file (.DGN) of each plotted "z" elevation at the "x" and "y" coordinate for each point found in the second ASCII coordinate file above shall be submitted. Soundings shall be on level 49, color coded elevations and buoys on level 52. The design file shall contain horizontal and vertical control used to develop the survey. An Intergraph digital terrain model (.DTM) file shall also be provided. For all work along the Mississippi River, the 1993 Low Water Reference Plane elevation shall be used as the zero contour. Digital sheets supplied by the Memphis District reflect true elevations but shall be reduced relative to the 1993 LWRP by the contractor. They shall be developed as three-dimensional graphic elements on level 57 to be loaded as breaklines to the .DTM file. Hydrographic survey shall be performed at the locations and intervals described in paragraph 2.c. and as described below:

- (1) Ranges. The ranges shall extend from water's edge to water's edge. The coverage shall include all dike fields, chutes, sandbars and islands that can be surveyed hydrographically. In addition, all navigation buoys within the defined area shall be located by an x and y position and plotted on the maps.
- (2) Sounding data (rounded to the nearest foot) shall be plotted at intervals of ± 100 feet using a text size of 80 (using Font 10). The contour interval shall be five feet and the contours shall extend from water's edge to waters edge. The zero contour shall be a dashed (---) line. The -10 contour shall be a solid line of heavier weight than the other contours. The hydrographic data may overlap with adjacent sheets. In these cases all hydro data shall be plotted on all overlapping sheets. All hydrographic maps shall be verified for accuracy by the contractor before final submittal to this office. All miscellaneous data (i.e. title blocks, gage data {furnished by Government}, slope diagrams, and data ranges were sounded) on the sheet shall be completed by the contractor.
- (3) All hydrographic survey ranges are to be sounded as nearly normal to the channel as possible. Computer generated contours cannot be developed accurately if ranges are at any noticeable angle. Where some angle cannot be avoided, range spacing should be decreased.
- (4) Each survey shall follow the REEGIS standards which are in the enclosure. Each survey shall use polyfill shapes for the color-coded contours instead of triangles.
- (5) The following files shall be submitted .DGN, .DTM and .XYZ files for the NGVD Elevation **and** for the Low Water Reference Plane.
- (6) A hardcopy plot of each completed hydrographic sheet shall be submitted containing the latitudinal and longitudinal grid, soundings, contours, color coded elevations, raster image, and title block.
- (7) Level 63 information as contained in Miscellaneous Intergraph Requirements and Specifications, dated 10 September 1992 shall be included in all files.

3. DATA SUBMISSION. The data required by these surveys shall be developed and submitted by 12 February 1999. No formal SER shall be required for this scope of work.

Figure C-8. Example Task Order Scope of Work – River Sections

Example Task Order Scope of Work--Revetment Surveys

PROPOSED TASK ORDER NO. 33
EMC, INC.
DACW66-98-D-0007

Scope of Work
Revetment Before Construction Survey at Norfolk-Star, MS
Approximate River Mile 711L AHP

1. General Scope. The contractor shall perform a revetment before construction survey at Norfolk-Star Revetment, MS. The purpose of this survey is to gather information for the possible extension of Norfolk-Star Revetment. The survey will consist of baseline recovery from Norfolk-Star Revetment baseline station 84+00 to station 75+00 and the establishment of 6000 ft of new baseline upstream from station 75+00. Soundings from water's edge to 800 ft. beyond water's edge and bank sections from water's edge to 150 ft. behind top bank will also be required.

2. Survey Requirements and Specifications.

a. Miscellaneous. See Miscellaneous Survey and Specifications (MSRS), dated 4 March 1993, paragraphs 1 through 8 for A-E responsibilities in regard to Quality Assurance, Submission of Pay Estimates, Safety, Project Progress Reports, Damages, Coordination of Work, Datums, and Survey Field Notes

b. Right-of-Entry. Right-of-entry has been obtained by the Memphis District Corps of Engineers.

c. Survey Limits. The limits for baseline recovery shall be from Norfolk-Star Revetment baseline station 84+00 to station 75+00. Section limits shall be from baseline station 84+00 to 6000 ft. upstream of station 75+00. Lateral limits shall be from 150 ft. behind top bank to 800 ft. beyond water's edge. Sections shall be taken at 100-ft. intervals. A Site Map is provided in Encl. 1.

d. Existing Horizontal Control. The Norfolk-Star Revetment baseline shall be re-established from baseline station 75+00 to baseline station 84+00 in accordance with MSRS, paragraph 11.a, 11.b, 11.d, and 11.f. Paragraph 11.b shall be amended to Third Order Class 2. Adequate horizontal control exists as herein furnished within a reasonable distance of the survey limits to perform this survey to the required accuracy specifications. Existing Norfolk-Star Revetment baseline coordinates are provided in Encl. 2. Note that these coordinates are provided in NAD 83 Geographic Coordinates with Corpscon translated coordinates of Norfolk-Star Revetment baseline to NAD 83 UTM Zone 15, U.S. Survey feet.

e. New Horizontal Control. New baseline shall be established in accordance with MSRS, paragraph 11.a, 11.b, 11.d, and 11.f. Paragraph 11.b shall be amended to Third Order Class 2. The new baseline shall stem from existing baseline station 75+00 and run 6000 ft. upstream of station 75+00 along the bar at River Mile 926R AHP, to new baseline station 40+00.

f. Horizontal Computations. Horizontal data shall be computed on the North American Datum of 1983 (NAD 83) using Universal Transverse Mercator (UTM) Zone 15 plane coordinates in U.S. Survey Feet. See MSRS, paragraph 12 for other requirements.

g. Existing Vertical Control. Vertical control information is provided in Encl. 3. See MSRS, paragraph 13.a, 13.b, 13.c, and 13.d for requirements.

g. New Vertical Control. Third order vertical control shall be established on all Type G or Type F monuments and iron pins installed as described in MSRS, paragraphs 13.a and 13.d. All new vertical control documentation shall be submitted as hard copy and in digital form using previously supplied database software.

h. Monumentation. Monumentation shall be as described in MSRS, paragraph 14.a. through 14.g. and as follows:

(1). Each monument or iron pin (baseline) shall be designated by the stationing preceded by the following character:

<u>BASELINE</u>	<u>DESIGNATION</u>	<u>EXAMPLE</u>
Norfolk-Star	NS	NS 75+00

Note: There shall be a space between the prefix and the stationing, not a dash.

A River List monument/marker documentation form shall be completed in accordance with MSRS, paragraph 14.f (1) for each Monument installed. All existing and new horizontal and vertical control marks used to complete this survey shall be included in the final data submittal.

(2). Each iron pin shall be stamped as described in MSRS, paragraph 14.c.

i. Field Book Documentation.

(1) Recover/Re-establish Norfolk-Star Revetment baseline within the survey limits in accordance with MSRS, paragraphs 11.a, 11.b, 11.d, and 11.f.

(2) Establish new baseline from station 75+00 to 6000 ft. upstream of station 75+00 in accordance with MSRS, paragraphs 11.a, 11.b, 11.d, and 11.f.

(3). Obtain bank sections at 100-ft. intervals. Sections shall extend from water's edge to 150 ft. behind top bank.

(4) Obtain soundings at 100-ft. intervals. Soundings shall extend from water's edge to 800 ft. beyond water's edge.

(5) All elevations shall be referenced to National Geodetic Vertical Datum of 1929. All horizontal positions shall be referenced to the North American Datum of 1983, using UTM Zone 15 plane coordinates in U.S. Survey Feet.

(6) The 1993 Low Water Reference Plane shall be used for contouring which equals 168.40 at mile 711L AHP.

j. Digital Map. Digital maps shall be developed and provided in digital format as described in MSRS, paragraph 23.a.

3. DATA SUBMISSION. The delivery date for the final SURVEY ENGINEERING REPORT shall be 1 March 1999. See MSRS, dated 4 March 1993, paragraph 24, for additional requirements.

Figure C-9. Example Task Order Scope of Work--Revetment Surveys

EM 1110-2-1003

30 Nov 13

Example Task Order Scope of Work--Project Condition Survey

TECHNICAL REQUIREMENTS
JACKSONVILLE HARBOR 30, 34, 38, & 42-FOOT PROJECT,
PROJECT CONDITION SURVEY, JACKSONVILLE,
DUVAL COUNTY, FLORIDA
(Survey No. 99-315)

1. LOCATION OF WORK. The project is located at Jacksonville Harbor, Jacksonville, Duval County, Florida.

2. SCOPE OF WORK.

2a. The service to be rendered by the Contractor includes obtaining hydrographic survey data as shown on Enclosures 1 (Plan drawings), and 2. Enclosure 3 is the technical requirements and Enclosure 4 is control monuments descriptions.

2b. The services to be rendered by the Contractor include all the work described in these technical requirements. Details not specifically described in these instructions are nevertheless a firm requirement if they can be identified as an item, or items, commonly a part of professional grade work of a comparative nature.

2c. The Contractor shall furnish all necessary rights-of-entry, materials, labor, supervision, equipment, and transportation necessary to execute and complete all of the work required by these specifications.

2d. The Corps of Engineers, Survey Section shall be contacted the same day that the Contractor plans to commence the work.

2e. Rights-of-Entry must be obtained verbally and recorded in the field book before entering on the private property. Enter in the field book the name and address of the property owner contacted for rights-of-entry.

2f. COMPLIANCE. Surveying and Mapping shall be in strict compliance with EM-1110-1-1000 for Photogrammetric Mapping, EM-1110-1-1002 Survey Markers and Monumentation, EM-1110-1-1003 NAVSTAR Global Positioning System Surveying, EM-1110-1-1004 Deformation Monitoring and Control Surveying, EM-1110-1-1005 Topographic Surveying, EM-1110-2-1003 Hydrographic Surveying, EM-1110-1-2909 Geospatial Data and System, (Tri-Service) A/E/C CADD Standards, (Tri-Service) Spatial Data Standards, Related Spatial Data Products and Chapter 177, Chapter 472, and Chapter 61G17 of the Minimum Technical Standards set by the Florida Board of Professional Surveyors and Mappers.

2f1. STANDARDS FOR DIGITAL GEOSPATIAL METADATA.

Metadata are "data about data". They describe the content, identification, data quality, spatial data organization, spatial reference, entity and attribute information, distribution, metadata reference, and other characteristics of data. Each survey project shall have metadata submitted with the final data submittal. Furnish a digital file using CORPSMET 95 (Metadata Software) with the appropriate data included. Enclosure 5 is an example of the metadata file printed. Point of contact in survey section is Mr. Bill Mihalik at 904-232-1462.

2g. All digital data shall be submitted on CD-ROM's.

3. FIELD SURVEY EFFORT. Obtain the hydrographic survey data for Cuts 3-19, Cuts 39-55, Terminal Channel, Cuts A, F & G as shown on Enclosures 1, and 2. Enclosure 3 is the control monument descriptions, Enclosure 4 is the technical requirements.

3a. CONTROL.

3a1. The Horizontal datum shall be NAD 1927. The vertical datum shall be NGVD 1929. All control monuments shall be verified both horizontally and vertically by a control survey. All control surveys shall be Third Order, Class II accuracy. All Positions will be tied to the state plane coordinate system, zone 0901 Florida East.

3a2. The basic control network shall be accomplished using precise differential carrier-phase Global Positioning System (GPS). Differential GPS baseline vector observations shall be made in strict accordance with the criteria contained in the engineering manual EM-1110-1-1003 and with the Geometric Geodetic Accuracy Standards And Specifications For Using GPS Relative Positioning Techniques by Federal Geodetic Control Committee, version 5.0.

3a3. Network design, station and baseline occupation requirements, for static and kinematic surveys, satellite observation time per baseline, baseline redundancies, and connection requirements to existing networks, shall follow the criteria given in the above said engineering manual. A field observation log shall be completed at each setup in the field.

3a4. GPS derived elevation data shall be supplied in reference to the above said datum. Existing benchmark data and stations shall be used in tandem in a minimally constrained adjustment program to model the geoid. All supporting data used in vertical adjustment shall be submitted.

3a5. Existing Corps of Engineers control data shall be tied into subject survey net. The GPS network shall commence from the control shown on Enclosure 2. All established or recovered control shall be fully described in accordance with the Technical Requirements of this contract. All control surveys shall be Third Order, Class II accuracy. The Contractor shall submit the field data and abstracts for the control networks to Survey Section for computation before commencing the mapping. The monument designations shall be furnished as requested. All horizontal and vertical control (double run forward and back) established shall be a closed traverse or level loop no spur lines, with third order accuracy. All horizontal and vertical control along with baseline layouts, sketches, and pertinent data shall be entered in field books. All monuments, survey markers, etc., recovered shall be noted on the copies of control descriptions. Control points established or recovered with no description or out-of-date (5 Years old) description shall be described with sketches for future recovery use. All original field notes shall be kept in standard (pocket size) field books and shall become the property of the Government. The first four pages of the field books shall be reserved for indexing and the binding outside edge shall be free of all marking.

3b. **TIDE STAFF:** Staff shall be located in the immediate vicinity of the work areas. The gauge shall be referenced MLW as shown on Enclosure 2 (Tide staff locations)

3c. The limits of the hydrographic survey are: Jacksonville Harbor, Cut-3 thru Terminal Channel, Cut-A, Cut-F & Cut-G. Take hydrographic cross-sections for the reaches listed below.

<i>Cut</i>	<i>Beginning Station</i>	<i>Ending Station</i>	<i>Azimuth</i>	<i>Sta. Interval</i>
3	0+00.00	300+00.00	96-53-41	100 feet
4	0+00.00	15+38.67	86-36-47	100 feet
5	0+00.00	13+58.23	66-17-49	100 feet
6	0+00.00	24+72.08	42-22-17	100 feet
7	0+00.00	28+21.83	21-18-33	100 feet
8	0+00.00	24+66.35	40-38-49	100 feet
9	0+00.00	24+23.63	65-36-03	100 feet
10	0+00.00	7+77.36	86-22-43	100 feet
11	0+00.00	6+08.86	98-23-01	100 feet
12	0+00.00	4+96.23	107-14-12	100 feet
13	0+00.00	18+14.83	116-51-38	100 feet
14/15	0+00.00	47+62.29	129-38-26	100 feet
16	0+00.00	13+31.28	120-17-44	100 feet
17	0+00.00	10+92.08	108-32-47	100 feet
18	0+00.00	8+98.59	91-46-22	100 feet
19	0+00.00	9+27.10	76-50-50	100 feet
39	0+00.00	36+57.85	60-42-50	100 feet
40	0+00.00	19+94.59	87-46-43	100 feet
41	0+00.00	29+54.53	114-28-25	100 feet
42	0+00.00	159+16.21	79-14-02	100 feet
43	0+00.00	21+57.00	112-50-00	100 feet
44	0+00.00	49+31.81	146-25-58	100 feet
45	0+00.00	40+47.22	136-44-10	100 feet
46	0+00.00	20+64.07	127-12-22	100 feet
47	0+00.00	14+95.67	107-30-00	100 feet
48	0+00.00	13+45.42	88-10-39	100 feet
49	0+00.00	20+41.57	68-43-49	100 feet
50	0+00.00	82+30.97	58-32-58	100 feet
51	0+00.00	58+57.42	16-40-20	100 feet
52	0+00.00	15+69.24	08-59-20	100 feet
53	0+00.00	12+92.85	342-49-45	100 feet
54	0+00.00	10+48.52	333-10-31	100 feet
55	0+00.00	40+11.32	309-07-42	100 feet
Term Ch	0+00.00	186+21.19	10-00-41	100 feet
A	0+00.00	53+10.21	161-45-23	100 feet
F	0+00.00	25+48.02	36-37-57	100 feet
G	0+00.00	149+36.21	17-11-17	100 feet

EM 1110-2-1003

30 Nov 13

Coverage should extend a minimum of 200-feet outside channel limits, wideners, and turning basins in all directions. Ensure that lines extend sufficient distance to cover Coal Terminal and proposed settling basin (enclosure 2) which are both adjacent to Cut-42. Coverage in proposed settling basin should extend a minimum of 400-feet in all directions as shown on enclosure.

3d. Priorities are given for this project as follows:

1. Terminal Channel, from Sta. 164+56 to southern terminus.
2. Cut-42 to Sta. 164+56 of Terminal Channel.
3. Cut-14/15 to Cut-19.
4. Cuts A, F & G
5. Cut-19 to Cut-42
6. Bar Cut-3 to Cut-14/15.

Once a priority is completed, mapping should be done and submitted as stated above .

3g. NAVAIDS. All Navigation's Aids (NAVAIDS) shall be located with coordinate positions (GPS) in or adjacent project area. Fixed NAVAIIDS shall be positioned four to five times and floating NAVAIIDS shall be positioned one time, with wind and tide direction recorded. Note type and condition of NAVAIIDS within the project limits. Warning signs, lights, and any existing regulatory markers, (information signs) within the project limits shall be positioned four to five times. Locate all NAVAIIDS in the entrance channel.

3h. DGPS. The hydrographic positioning system shall be a Differential Global Positioning System utilizing the USCG Nav-beacon system as the reference station. The positioning system shall be checked with two control monuments and recorded along with setup data (input data to the GPS) in the field book. Hydrographic survey log sheets shall be filled out and submitted along with the field book.

3i. SOUNDING POLE 6" DISK. Utilize a 6 inch diameter disk attached to the bottom of the sounding pole or lead line at all times when collecting conventional soundings.

3j. Breakline. Breaklines shall be located for all natural or man-make features as needed. The breaklines shall be located with X, Y and Z and identified.

3k. DATA COLLECTION (TOTAL STATION). Data collection will be allowed for data points only, showing all instrument positions, calibration, backsites and closing readings in the field book.

4. DATA PROCESSING. The Contractor shall make the necessary computations to verify the correctness of all measurements and apply the proper theory of location in accordance with the law or precedent and publish the results of the survey. Compute and tabulate the horizontal and vertical positions on all work performed. Furnish X, Y, and Z points file for each profile line with descriptors shown for all land features located west of and including the monument at point collected, landward side (one file with land, one file with water, one with land and water data merged). Review and edit all field data for discrepancies before plotting the final drawings. Tabulate a list of the tide staff locations and bench mark designations used for the survey. Furnish ASCII X, Y, Z files with negative sign if elevation is negative.

5. CADD. The survey data shall be translated or digital capture into Intergraph IGDS 3D design files according to the specifications furnished. The survey data (cover, control, site plan, plan sheets, and section drawings) shall be provided in Intergraph MicroStation (PC or 32) Version 4.0 or higher, AT&T System V Unix, CLIX R3.1 Ver. 6.3.2 format as shown in the letter dated 30 September 1992.

5a. GLOBAL ORIGIN. The IGDS 3-D design file shall be prepared with a global origin of 0, 0, 2147483.65, Design file master units: FT., Sub units: 1,000, and positional units: 1. The file name shall be the survey number prefixed to an "A," i.e., A315.DGN. All reference file names shall commence with the A315 also.

5b. Digital Terrain Model (DTM) Data. The Contractor shall develop and deliver a surface model of the survey area using Intergraph compatible Digital Terrain Modeling software and the model file shall have the .dtm extension. The digital terrain model shall be developed from cross sections, spot elevations, and breaklines. Breaklines should include ridges, drainage, road edges, surface water boundaries, and other linear features implying a change in slope. The surface model shall be of adequate density and quality to produce a one foot contour interval derived from the original DTM (Digital Terrain Model) file. The contour data shall be incorporated as a reference file into the final data set. All data used to develop the DTM's shall be delivered in Intergraph 3-D design files.

5b1. Contours. The contours shall be developed in the digital terrain model (DTM). The contours shall be provided in one or more master data base DGN files, attached as a reference file to all sheet files utilizing the clip bounds methods. Each contour shall be drawn sharp and clear as a continuous solid line, dashed contours are not acceptable. Every index contour shall be accentuated as a heavier line than the intermediate and shall be annotated according to its actual elevation above NGVD Whenever index contours are closer than one-quarter (1/4) inch, and the ground slope is uniform, the intermediate shall be omitted. Labeling or numbering of contours shall be placed on top of the contour line, so that the elevation is readily discernible, do not break contours. Labeling of intermediate contours may be required in areas of low relief.

5c. MODEL DGN FILES (SCALE 1:1). The overall hydrographic data (collected data points) shall be provided in one or more master DGN file attached as a reference file to all sheet files utilizing the clip bounds methods. The project depth (30, 34, 38, & 42-foot) contours shall be provided in one or more master DGN file attached as a reference file to all sheet files utilizing the clip bounds methods. The control data points shall be provided in one or more master DGN file attached as a reference file to all sheet files utilizing the clip bounds methods.

5d. COVER AND CONTROL SHEET. The first sheet shall be a cover sheet showing the control sketch, survey control tabulation, sheet layout or index, legend, project location map, survey notes, north arrow, graphic scale, grid ticks, and large signature block. Tabulate, plot, and list the horizontal control used for the survey on the final drawings. In addition show a table on this sheet showing the X and Y coordinates, station and elevation for each point and monument.

5e. PLAN SHEETS. The plan sheets shall be prepared to a scale of 1"=100', in the Corps of Engineers format showing notes, title block, grid, north arrow, graphic scale, legend, sheet index, and D. O. File Number. The data shall be plotted at 12.5-foot intervals. The extreme right 7 inches of the sheet shall be left blank for notes, legends, etc. The second sheet and all sheets following shall be a continuation sheet and shall have a minimum of two notes, note 1: See Drawing number 1 for notes, note 2: Refer to Survey No. 99-315.

5f. Section Views. The sections shall be extracted and displayed from the digital terrain model (DTM OR TNT) utilizing INROADS OR INXPRESS. The sections shall be generated or extracted along the same azimuth as the section was collected in the field. The sections shall be displayed at a 10 to 1 vertical exaggeration. The planimetric lines (alignment of extraction), alignment, stations, and cross sections shall be displayed in one DGN file. Paper plots "**NOT REQUIRED**".

6. Map Content.

6a. Coordinate Grid (NAD 83). Grid ticks (English) of the applicable State Plane Coordinate System shall be properly annotated at the top, bottom and both sides of each sheet. Spacing of the grid ticks shall be five (5) inches apart.

6b. Control. All horizontal and vertical ground control monuments shall be shown on the maps in plan and tabulated.

6c. Topography. The map shall contain all representable and specified topographic features, which are visible or identifiable.

6d. Spot Elevations. Spot elevations shall be shown on the maps in the proper position.

6e. Contours. The contours shall be developed in the digital terrain model (DTM). The contours shall be provided in one or more master data base DGN files, attached as a reference file to all sheet files utilizing the clip bounds methods. Each contour shall be drawn sharp and clear as a continuous solid line, dashed contours are not acceptable. Every index contour shall be accentuated as a heavier line than the intermediate and shall be annotated according to its actual elevation above mean sea level. Whenever index contours are closer than one-quarter (1/4) inch, and the ground slope is uniform, the intermediate shall be omitted. Labeling or numbering of contours shall be placed on top of the contour line, so that the elevation is readily discernible, do not break contours. Labeling of intermediate contours may be required in areas of low relief.

6f. Map Edit and Accuracy. All names, labels, notes, and map information shall be checked for accuracy and completeness. All commercial buildings, roads and man made features shall be labeled with the type of construction, purpose and name. All residences shall be labeled with the type of construction. All mapping shall conform to the national map accuracy standards except that no dashed contour line will be accepted.

7. Office Review and Computations: The Contractor shall make the necessary computations to verify the correctness of all measurements and apply the proper theory of location in accordance with the law or precedent and publish the results of the survey. The contractor shall submit the original field notes and horizontal and vertical abstract (computation abstract) to Survey Section for final computation before mapping commences.

8. DELIVERIES: On completion, all data required shall be delivered or mailed to Design Branch, Survey Section at the address shown in contract, and shall be accompanied by a properly numbered, dated and signed letter or shipping form, in duplicate, listing the materials being transmitted. All costs of deliveries shall be borne by the Contractor. Items to be delivered include, but are not limited to the following:

8a. GPS network plan, (before GPS work commences).

8b. GPS raw data along with field observation log sheets filled out in field with all information and sketches.

8c. Computation files with Horizontal and Vertical abstracts along with any Q1 and Q2 files.

8d. Horizontal and Vertical Field Books.

8e. Furnish X, Y, and Z ASCII file for the longitudinal centerline.

8f. DTM Files (one overall and one per cut)

8g. DGN files. (scale 1" = 100')

8h. Plans plots at a scale of 1" = 1'00. 1 copy is requested with a contour shown inside channel at project depth. Project depth is 42-feet from Sta. 0+00 of Bar Cut-3 to Sta. 210+00 of Bar Cut-3, 38-ft from Sta. 210+00 of Bar Cut-3 to Sta. 164+56 of Terminal Channel, 34-feet from Sta. 164+56 of Terminal Channel to terminus of Terminal Channel, and 30-feet in Cut-A, F, G.

EM 1110-2-1003

30 Nov 13

8i. Volumes: Perform necessary calculations to compute volume of material above project depth (plus 1 & 2-feet below) over surveyed area. Provide a spreadsheet showing computed results.

8j. Furnish a digital file using CORPSMET 95 (Metadata Software) with the appropriate data included.

8k. Raw HYPACK Log Files.

Enclosures (withdrawn in example)

Figure C-10. Example Task Order Scope of Work-Project Condition Survey

THIS PAGE INTENTIONALLY LEFT BLANK

APPENDIX D

General Background on Hydrographic Survey Accuracy Estimates

D-1. Purpose and Scope. This appendix provides supplemental background information on some of the statistical terms and depth error propagation issues covered in Chapter 3. It contains examples of techniques that may be used to estimate the accuracy of depth measurements. Some of the material in this appendix was incorporated from discussions at Multibeam User Group conferences held in the North Atlantic Division during the mid-2000's, and from the NOAA "NOS Hydrographic Surveys Specifications and Deliverables" manual (NOS 2011) and the NOAA "Field Procedures Manual,"(OCS 2011).

D-2. Definitions of Statistical Terms. Various statistical terms are used to describe the required or resultant "accuracy" of an observed depth. These include "error," "standard deviation," "uncertainty," "TPU," "confidence," "precision," and "repeatability."¹ Often these terms are misused, interchanged, and not always rigidly defined in specifications. Definitions of these statistical terms are provided in numerous texts and publications, such as those listed in Appendix A. The following definitions apply to the specific use of the terms in this manual.

a. Accuracy. Accuracy is a statistical terms that is often misused in specifications. It is classically defined as the "degree of closeness of a measurement to its true value." Since all depth measurements contain errors (uncertainties), the "true depth" measured at a point is rarely, if ever, absolutely known. This is especially true of underwater acoustic depth measurements in varying topography and sediments, along with often highly variable acoustic reflectivity, absorption, and refraction characteristics. Accuracy is traditionally used in a survey specification as requiring the measured depths to meet some type of "±" dispersion statistic, such as a standard deviation or TVU (e.g., ±1.0 ft); however, measuring or verifying that the survey actually met this type of "±" dispersion is extremely problematic.

b. Accuracy Standard. An "accuracy standard," as traditionally used in USACE engineering practice, is defined as meeting some statistical performance measure. This may be meeting some "repeatability" or "standard deviation" criteria based on calibration Performance Tests, or meeting some "TPU" dispersion level based on error budget estimates. For example, a required depth accuracy standard may specify that internal Performance Tests on a dredge clearance survey "should be repeatable to 0.2 ft. and that the 95% standard deviation not exceed

¹ Note that various international and national standards organizations have recommended replacing the terms "accuracy" and "error" with the somewhat equivalent term "uncertainty." This manual continues use of "accuracy" as it is recognized throughout USACE engineering practice. However, it is recommended that "uncertainty" be used to indicate data quality estimates on survey drawings furnished to the public or other federal organizations.

(± 0.5 ft)." Alternatively, an accuracy standard may specify that a general project condition survey should be performed to meet an IHO "Special Order" TVU standard of ± 0.8 ft.

c. **Quality Control.** Throughout this manual a variety of QC procedures are prescribed for survey instrumentation and data collection techniques in order to minimize systematic and random uncertainties in individual data points. QC procedures may include bar checks, velocity casts, patch tests, instrument alignment tests, vessel velocity limitations, multibeam beam-width restrictions, and maintaining overlapping coverage limits. Recommended single-beam and multibeam QC procedures are contained in their respective chapters in this manual, in equipment manufacturer's operating manuals, and in the NOAA "Field Procedures Manual" (OCS 2011). Performing all recommended QC procedures does not necessarily ensure that the resultant depth or elevation data will meet the standards in Table 3-1.

d. **Performance Standard.** A performance standard defines the minimal quality control (QC) calibration procedures and quality assurance (QA) tests (e.g., Performance Tests). The QC and QA performance standards recommended in this manual are not mandatory requirements—they should be modified as required to meet the required accuracy standard for a particular project.

e. **Performance Tests.** Repeatability is typically estimated from Quality Assurance Performance Tests—single beam cross-section checks (Chapter 4) or multibeam surface comparisons (Chapter 6). Poor repeatability indicates biases are present in the measurement system. Repeatability is a critical measure for dredge measurement and payment surveys.

f. **Repeatability.** Repeatability is defined as "the closeness of agreement between the results of successive measurements carried out under the same conditions of measurement" (JCGM 100 2008). These conditions include: the same measurement procedure, the same observer, the same measuring instrument used under the same conditions, the same site location, and repetition over a short period of time. For dredging measurement and payment surveys of a specific navigation project, these conditions of measured repeatability would include: using the same vessel, survey system, calibration procedures, tide/water level and geoid measurement methods, and performed over a short environmental time interval.

g. **Bias.** When multiple surveys are conducted over the same area (e.g., an acceptance section or in a small cell), the repeatability of these depth observations may be statistically estimated by computing the differences between the means of overlapping observations. The accumulated differences are an indication of a "bias" between the surveys. Repeatability is expressed as a bias difference between the comparison surveys—e.g., $+0.03$ ft or $(-) 0.2$ ft. For multibeam systems, the bias may vary by beam angle.

h. **Repeatability versus Accuracy (Standard Deviation).** A survey can show a high degree of repeatability but not be accurate. This is because accuracy (uncertainty or TPU) estimates

include many biases and errors that are not uncovered by Performance Tests run by the same vessel and system. These include datum uncertainties, calibration biases, bottom reflectivity characteristics, and acoustic signal processing biases. For example, a survey Performance Test in a deep-draft navigation project may show a repeatability of, say +0.05 ft, but have a 95% standard deviation of ± 0.8 ft.

i. **Reproducibility of depth measurements.** Reproducibility is defined as "the closeness of the agreement between the results of measurements carried out under changed conditions of measurement" (JCGM 100 2008). For hydrographic surveys, changed conditions would involve depth measurements made over the same project area (or cell) by different vessels, different measurement systems, different environmental conditions, different calibration methods, different acoustic frequencies, different tidal conditions, different times (e.g., days apart), etc. A measure of reproducibility is observed when comparing surveys by two vessels survey of the same area, a common occurrence on dredging contracts when the government and dredging contractor's vessels survey the same acceptance section. Both vessels have differing error propagation estimates and differing precisions. Reproducibility is a better estimate of "repeatability" since Performance Test comparisons between different vessels/systems are more independent, and are more likely to uncover differing biases in each system.

j. **Confidence.** Survey confidence is roughly defined as the probability that the true value of a measurement will lie within some specified accuracy or uncertainty from the measured value. Confidence is specified as a " \pm " statistic at a 95% level and is derived from standard deviation or uncertainty error propagation estimates. It is usually based on the statistics from repeated sample standard deviations, i.e., the "standard error of the mean" statistic, which is not the same statistic as a 95% standard deviation, RMS, or TPU. However, in practice, confidence is often substituted for 95% standard deviation. Use of confidence statistics requires the same caution as that for TPU or standard deviation—the method by which it was computed (estimated) must be clearly defined. Confidence computations based on Performance Test comparisons obtained by the same vessel may contain unknown biases that may skew the "true" confidence of a clearance survey. Therefore, using the term "confidence" may incorrectly imply some absolute certainty in the data that is not correct—a "95% standard deviation" would be a more appropriate term. Computed confidence levels may be of some use in assessing "risk assessment" measures, such a channel clearance confidence. Commercial software, such as CUBE (Combined Uncertainty and Bathymetry Estimator) provides uncertainty hypotheses or "confidence" estimates for selecting a representative depth when multiple depths are observed in the same area.

D-3. **Total Propagated Uncertainty.** Total Propagated Uncertainty (TPU) is the result of uncertainty error propagation, when all contributing measurement uncertainties, both random and systematic, have been included in the propagation. Uncertainty propagation combines the effects of measurement uncertainties from several sources upon the uncertainties of derived or calculated parameters. These include, but are not limited to, uncertainties in the geodetic

framework (WGS84, GRS80, NSRS), vertical datum reference gage datum uncertainties (MLLW, MSL, LWRP), vessel motion (roll, pitch, heave, yaw), geoid model errors, tidal phase and range model errors, acoustic measurements, bottom reflectivity, etc. TPU estimates are derived using standard Mean Square Error (MSE) propagation methods. This includes treating minimized (by calibration) systematic errors (biases) as random variables (see JCGM 100 2008).

a. Total Horizontal Uncertainty (THU). THU is the component of total propagated uncertainty (TPU) calculated in the horizontal plane. THU is a two-dimensional quantity. The uncertainty of a horizontal position of an observed depth is the uncertainty at the position of the depth within the geodetic reference frame. The estimated positional accuracy is usually specified as a two-dimensional radial error at the 95% level. A measured/resolved depth typically represents the acoustic return over a relatively large horizontal area (footprint) on the bottom—the acoustic footprint can often be larger than a grid cell size being assessed for channel clearance. Depending on many factors, the horizontal position of the depth's footprint on the bottom can have uncertainties ranging from ± 2 to more than ± 10 ft.

b. Total Vertical Uncertainty (TVU). TVU is the component of total propagated uncertainty calculated in the vertical dimension. TVU is a one-dimensional quantity. Vertical uncertainty is to be understood as the uncertainty of the reduced (corrected) depths. In determining the vertical uncertainty, the sources of individual uncertainties need to be quantified. All uncertainties should be combined statistically (using Mean Square Error techniques) to obtain a total vertical uncertainty.

c. "IHO Standards for Hydrographic Surveys" (IHO 2008) emphasizes that "...the adequacy of a survey is the end product of the entire survey system and processes used during its collection. The uncertainties outlined in IHO 2008 reflect the total propagated uncertainties of all parts of the system ... simply using a piece of equipment that is theoretically capable of meeting the required uncertainty is not necessarily sufficient to meet the requirements of these [IHO] Standards. How the equipment is set up [calibrated], used and how it interacts with the other components in the complete survey system must all be taken into consideration ..." Section A.4 of IHO 2008 (at Appendix E) lists many of the error sources that make up the total propagated uncertainty of a multibeam survey system.

D-4. Hydrographic Survey Error Propagation. Figure D-1 illustrates how survey errors propagate through the positioning and depth measurement systems, resulting in an estimate of the three-dimensional (3D) error ellipsoid representing the Total Propagated Uncertainty of the measurement. These errors are described in the following paragraphs. For additional guidance on depth error propagation, refer to the NOAA "NOS Hydrographic Surveys Specifications and Deliverables" manual (NOS 2011) and the NOAA "Field Procedures Manual," (OCS 2011).

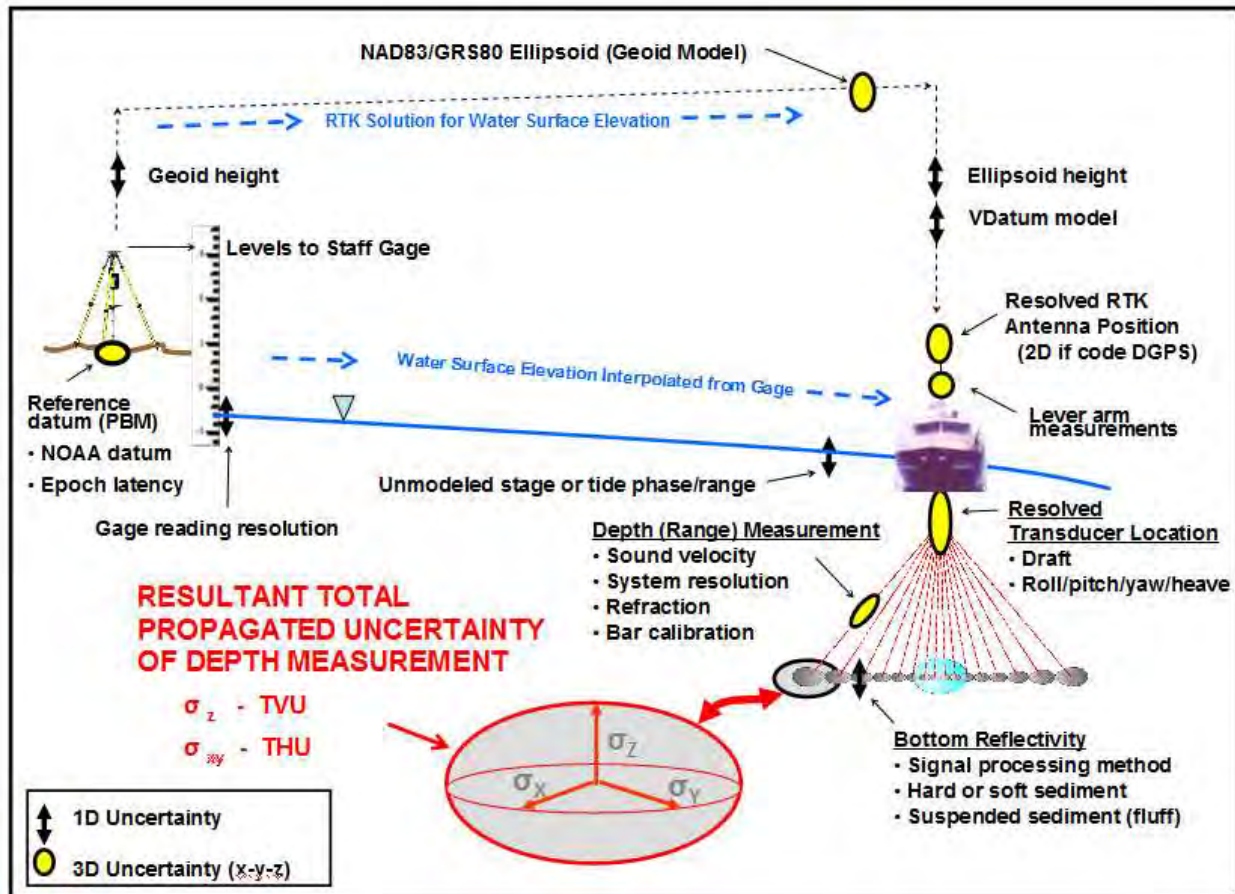

Figure D-1. Total Propagated Uncertainty of a multibeam depth. Major measurement system error components are indicated by arrows or ellipses. The elevation of the water surface at the vessel is determined by either (1) extrapolated gage reading or (2) RTK ellipsoid observations.

a. Reference benchmark uncertainties. Tidal benchmark elevations used to reference measurement, payment, and clearance surveys at a project are subject to uncertainties. The stability of the bench mark could be subject to regional settlement or uplift. The MLLW datum has an uncertainty dependent on the length of the time the gage was in place, the distance from a primary gage, and other factors. The uncertainty of the computed MLLW datum at a gage site can range from ± 0.1 ft to as much as ± 0.25 ft. It is also assumed that a primary reference bench mark (e.g., a "PPCP") is used to control all surveys performed at a given project site. If different bench marks are used, and inconsistencies between these bench marks are found to exist (height or MLLW datum), then these uncertainties would be propagated into the TPU estimates. An example would be uncertainties in a tidal zoning model.

(1) Biases in tidal models, tidal epoch latencies, reference datum biases, tidal bench mark settlement, sea level change, reference datum adjustments, geoid readjustments, and other largely indeterminate factors. These are biases that are difficult or nearly impossible to measure or correct for. They are generally not factored in dredge clearance assessment. This is because these biases are present in all repeated surveys over the project, assuming the same vertical reference tidal bench mark is used on a given project. They do, however, enter into the estimated uncertainty of a reported channel clearance to the public and cost estimates for dredging.

(2) For example, sea level rise occurring between NOAA tidal epoch updates at a project could be as much as 0.2 ft. Thus, the MLLW datum at the reference bench mark would have a constant bias of 0.2 ft and the reported channel clearance constantly off by that same amount. This equates to overdredging the project by a constant 0.2 ft, which may have significant budget impacts.

(3) The use of outdated or undefined local reference datums will also cause systematic biases in the maintained or reported project depth. Datum biases of upwards of 2 ft have been known to occur, resulting in incorrectly reported or interpreted channel clearance depths.

b. Reference water level staff gage resolution. The resolution of the gage reading will have additional uncertainty, especially on unstilled river or tidal staff gages where visual water surface estimates are made. RTK systems must be calibrated to this same staff gage. Depending on wave conditions at the gage, uncertainties in reading the gage can exceed ± 0.1 ft.

c. Geoid uncertainties. Geoid undulations occurring over a project must be modeled if RTK methods are used to measure the water surface elevation. Geoid model uncertainties in coastal areas are typically at the 1 to 3 cm range, with predicted uncertainties slightly larger (5 cm) in offshore entrance channels. There are no practical methods of refining the model in offshore models; however, since these uncertainties are systematic to all users of the same model, survey repeatability (or more importantly, reproducibility) is not impacted.

d. Extrapolated or interpolated water surface elevation at project site. Hydrographic depth measurements are reduced and referenced to the local water surface at the time the measurement is made. This water surface is normally referenced to an on-shore reference benchmark or gage as shown in Figure D-1. The most significant error component involves the assumed stability (levelness) of the water surface between the on shore gage and the survey vessel. This stability is usually valid in most non-tidal lakes, impoundment reservoirs, and rivers where extensive stage surface modeling has been performed, and staff gages can be set at every 0.2- to 0.4-ft change in river slope. In these areas, interpolated (or extrapolated) vertical reference accuracies within ± 0.1 ft may be attainable. However, on coastal navigation projects subject to tidal influences, any surface gradients between the gage and underway vessel must be corrected, using tidal models and/or in conjunction with inertial-aided RTK measurements.

(1) Estimating extrapolated surface elevation uncertainties. Extrapolated gage observations to an offshore location become more uncertain as the distance to the project site increases, especially in tidal waters with large phase and range variations. Interpolated river stages from distant gages also become uncertain over large distances. Estimating this extrapolation (or interpolation) error component is difficult—especially in areas with large tidal phase and range variations between the gage and project site. Estimating river gradient interpolation errors may also be difficult, especially where hydrodynamic surface variations exist between distant gages. Generally, a "worst case" estimate is used.

(2) Tidal zoning model uncertainties. Various tidal zoning models have been developed to estimate phase and range differences between the gage and the offshore project area. Since tidal gradient variations involve time and location-dependent parameters, on-line or after-the-fact correction may be difficult and time-consuming. Tidal zoning models contain numerous internal uncertainties, the largest being wind and current effects on the model. Estimating uncertainties in the zoning model due to these variations is difficult—again, a "worst case" estimate must be used.

(3) Tidal phase and range variations. Tidal datum phase and range variations over a project may be subject to uncertainties if not minimized by some form of hydrodynamic modeling. In tidal waters, the NAVD88-MLLW elevation difference (often termed a "KTD" file) may vary between the gage and project site. NOAA's "VDatum" models this variation. Any uncertainty in this KTD model is eliminated if all users apply the same model corrections. (VDatum is a software model developed by NOAA's National Geodetic Survey (NGS), Office of Coast Survey (OCS), and Center for Operational Oceanographic Products and Services (CO-OPS). VDatum transforms geospatial data among a variety of tidal, orthometric and ellipsoidal vertical datums.)

e. RTK surface elevation measurements. As indicated in Figure D-1, as an alternative to imprecise extrapolation methods, inertial-aided RTK techniques may be used to determine the water surface elevation at the vessel location. This is done by filtering long-term GPS observations to obtain an average surface elevation (i.e., "RTK Tide"). If RTK-derived water surface elevations are measured, coupled with inertial-aided GPS systems to correct vessel motions (e.g., POS/MV), then the uncertainty of the water surface elevation measurement at the project site may be minimized. RTK measurements contain numerous internal errors that must be factored into any uncertainty estimate. These include errors in the geoid model, RTK resolution, IMU drifts, and antenna-water surface-transducer lever arm measurements on board the survey boat. Corrected RTK surface measurement accuracies are typically at the ± 0.2 ft level.

f. Vessel static and dynamic draft errors. Since echo sounding instrument calibrations are performed while the vessel is stationary, the "draft" index derived during that calibration may vary from the index occurring while the vessel is under way. This dynamic draft is due to

changes in the vessel's trim while under way. It is systematic and varies as a function of velocity through the water. A squat calibration is performed to measure the change of trim. However, the squat calibration process itself is not very precise, especially on smaller boats where personnel and loading characteristics (e.g., fuel usage) can vary between the time of the squat test and the time of the actual survey. Vessel loading changes may also occur during the course of an actual survey. Errors due to inadequate compensation for the varied index, loading, and dynamic draft variations are systematic and can be significant, especially on small boats with side-mounted transducers. If not calibrated, these errors can approach ± 0.5 ft in some instances. (See Chapter 4 for details.) Use of RTK for vertical water level corrections helps minimize these errors.

g. Vessel stability and orientation errors. Sea conditions obviously impact the ability to reference a depth measurement to the uniform water surface alongside the survey vessel with precision. This applies to difficulties in correcting the superimposed effects of sea roll, pitch, and heave on a depth measured with an echo sounder. Thus, depending on the severity of sea conditions, an individual elevation (or sounding) contains an error component resulting from this source. If no motion compensation is used these errors can be ± 1 ft or more. Inertial-aided GPS systems are used minimize this error. A number of internal errors are associated with inertial-aided GPS motion compensation systems, such as lever arm measurements, IMU biases, latencies, etc. These internal errors must be estimated in any uncertainty analysis. Refer to additional guidance in NOAA 2011.

h. Depth measurement system errors. All the various measurement errors (e.g., velocity and refraction) associated with the acoustic measurement system propagate downward to the bottom, as shown in Figure D-1. At the bottom surface, other acoustic reflectivity factors propagate into the error budget, such as the signal processing and analysis of the apparent acoustic reflection return. These errors are described in Chapters 4 and 6. In areas with suspended sediments, determining the depth of a return signal from a given material density becomes complex (See Appendix P). The precision of any depth measurement will, in general, degrade as a function of water depth, and slope distance on multibeam systems. This is due to a number of electronic and physical factors inherent in the sound travel-time measurement process, i.e., changes in water temperature, salinity, etc. Multibeam depth measurement uncertainty typically degrades (increases) over the outer beams on the array, depending on the type of depth determination method employed (amplitude, phase, interferometric) and the bottom characteristics or reflectivity. Beam refraction (ray bending) can also be a problem if sound velocity measurements are not correct. These errors are minimized by frequent calibration of the echo sounding equipment.

i. Echo sounder calibration. Errors and uncertainties associated with calibrating acoustic systems were described in Chapters 4 and 6. These include errors in the bar check calibration, velocity profiles, and Patch Tests.

j. Bottom material density variations. The relative density of the bottom material affects all depth measurement methods, especially echo sounding instruments that are highly dependent on finite density changes (acoustic impedance changes) to distinguish between and record acoustical returns. On sounding poles, sounding disks, and lead lines, the surface area, weight, and drop velocity determines their stopping or refusal points. In many instances, these points are difficult to establish, especially when these devices continue to free-fall under their own weight in low-density sediments. Echo sounding returns are dependent on the frequency of the acoustic pulse, receiver sensitivity settings, and distinct density (impedance) changes in the subsurface material. Bottom material densities may even vary across a single multibeam swath. Other difficulties arise in areas with suspended sediments (fluff) present, such as naturally occurring fluff or disturbed sediments from dredging operations. Small variations in sensitivity (or signal gain) settings on the echo sounder can cause large variations in the return point. These errors are systematic, and no definitive methods exist to fully compensate for them; let alone estimate error uncertainties for them.

D-5. Resultant Total Propagated Uncertainty. The resultant TPU ellipsoid shown in Figure D-1 will typically be elongated in the X-Y plane (THU) due to a higher uncertainty in the horizontal location of the depth observation.

a. Total Horizontal Uncertainty (THU). The horizontal uncertainty is dependent on the positioning system accuracy (DGPS or RTK). This positioning error propagates down from the vessel antenna, through the system orientation sensors, to the bottom. Horizontal uncertainty increases with acoustic footprint size, which, in turn, is dependent on beam width and depth (and location on a multibeam array). Obviously, a single beam depth or multibeam nadir depth in 10 ft of water will have a much smaller horizontal footprint than a multibeam depth 45 deg from nadir in 50 ft of water. Note also that the THU shown in Figure D-1 includes uncertainty in the NSRS horizontal datum. This is usually negligible (<2 cm) when published NSRS/CORS points are used to control the survey.

b. Total Vertical Uncertainty (TVU). As illustrated in Figure D-1, depth uncertainty is dependent on the propagating errors outlined above. The vertical uncertainty will normally be less than ± 1 ft (95%) under average conditions. It can be as small as ± 0.2 ft when surveying hard bottom in non-tidal waters a few hundred ft from a reference gage. It can be as large as ± 2 ft when surveying in unmodeled tidal waters 10 miles distant from a reference gage. As with THU, TVU includes any uncertainty in the vertical datum at the reference gage, such as published NOAA NWLON tidal datums or inland low water reference planes (LWRP).

c. Minimizing TPU. Some of the error components shown in Figure D-1 will be minimized (and even eliminated) when the same vessel and acoustic system is used at a project site. Uncertainty in the reference datum at the gage is such an example—the X-Y-Z coordinates are assumed absolute regardless of NSRS datum uncertainty. Likewise, the MLLW datum model at the project site will be assumed constant (e.g., from a VDatum model) as will any geoid

model height uncertainty. If the bottom has a consistent density, and the processor sensitivity and gain settings are kept constant during repeated surveys, then some of these variables will be considered constant within this particular measurement system. This will result in repeated comparisons surveys in a given area agreeing with one another at less than the 0.1 ft level—i.e., "repeatability" not "accuracy." Use of inertial-aided RTK from a "fixed" reference datum (gage) will have a major effect in reducing relative accuracy levels down to < 0.1 ft repeatability levels. (Repeatability is assessed by comparing intersecting or overlapping points from two different surveys (e.g., Performance Tests), and computing the mean deviation of all the differences. Individual points may differ by large amounts in irregular bottoms (e.g., ± 1 or more ft); however, if the mean or average deviation between the thousands of overlapping points is small (e.g., < 0.1 ft), then a good repeatability measure is indicated. This would also indicate minimal biases exist between the surveys.)

D-6. Estimating a Survey Uncertainty Allowance on USACE Navigation Projects. Estimating the uncertainty or TPU is complex, and must include individual error estimates for the numerous measurement system and environmental condition variables outlined above. These error estimates can be based on known uncertainties in each system component, from those provided by the individual sensor manufacturers, or obtained in guidance from other agencies (e.g., NOAA). Other error estimates may be gained from repeated observation experience, such as sound velocity or draft calibration consistency, and Performance Tests.

a. Required dredging grade uncertainty allowance. The design navigation grade or required dredging template should contain an allowance for uncertainties in the reference datum, tidal models, and survey accuracies. This allowance is dependent on a statistical analysis of the entire measurement system, along with estimated hydrodynamic, meteorological, geomorphological, and environmental conditions occurring at a specific project site. This uncertainty assessment should be performed during the feasibility or PED phase, and reviewed when developing construction plans and specifications for new work or maintenance dredging.

b. Survey uncertainty tolerance. This survey uncertainty allowance may be factored in the tolerances used in the original studies that determine the authorized navigation depth for a project—see EM 1110-2-1613, Hydraulic Design of Deep-Draft Navigation Projects. This uncertainty allowance (or tolerance) can also play in the evaluation of dredge clearance survey data and in the significant figure (rounding) resolution of recorded depths and clear grades. Figure D-2 illustrates the uncertainty allowance estimate relative to (i.e., above and below) a nominal or required clearance grade. This uncertainty may or may not be significant on soft bottom maintenance dredging projects; however, on new work or rock-cut channels, this allowance may need to be applied to the overdepth allowance to provide additional confidence that the final channel clearance is to grade. Any survey uncertainty allowance must consider the survey system intended for use on the project; especially variations in beam angle accuracies of multibeam systems.

c. Due to the difficulty in estimating some of the error components in a formal TPU computation, practical engineering judgment must often be used in establishing an uncertainty tolerance for a navigation project. Thus, a constant “tolerance” (i.e., confidence) may be estimated from a TPU evaluation for a specific navigation project, and that tolerance used for the entire survey or dredging contract. The survey tolerance may also be estimated from past results, such as from deviations and biases in past Performance Tests.

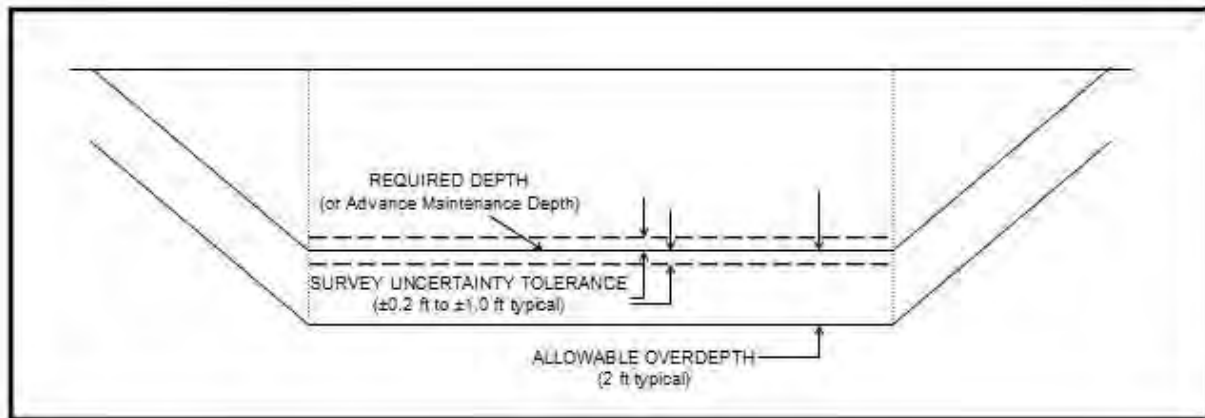

Figure D-2. Survey uncertainty allowance on a typical maintenance dredging template.

D-7. Examples of TPU Estimates for USACE Navigation Projects. The following paragraphs and tables contain simplified examples of TPU estimates for navigation projects. Typical error ranges are also listed for the major system components.

a. Coastal navigation project depth measurement uncertainties (Table D-1). This list differentiates between the survey procedures used to measure the water surface at the offshore project site—(1) unmodeled surface elevation extrapolation from a shore-based tide gage or (2) direct RTK surface elevation measurement at the project site—see Figure D-1. This example is not inclusive of all the measurement factors that make up a depth measurement.

Table D-1. Estimated Depth Measurement Uncertainties in a Typical Coastal Navigation Project. (From EM 1110-2-6056)

Measurement Factor	Uncertainty Range
<u>Reference Datum:</u>	
Tidal gage MLLW reference datum accuracy (NOAA)	0.1 - 0.2 ft
Tidal epoch latency (update lag during 19-year period)	0.05 - 0.1 ft
Tide staff leveling accuracy	0.02 - 0.05 ft

Tide staff visual reading resolution	0.02 – 0.1 ft
<u>Acoustic depth measurement system uncertainties:</u>	
includes sound velocity, refraction, reflectivity, bar calibration uncertainties, etc.	
Depths < 15 ft	0.05 – 0.1 ft
Depths 15 ft to 40 ft	0.1 – 0.3 ft
Depths > 40 ft	0.3 – 0.5 ft
<u>Heave-Pitch-Roll uncertainties:</u>	0.1 – 0.5 ft
<u>Draft uncertainties (Static/Dynamic):</u>	0.05 – 0.2 ft
<hr/>	
<u>Extrapolated Water Surface Elevation from Gage:</u>	
MLLW range gradient (unmodeled/estimated)	0.05 - 0.3 ft
Tidal phase lag (gage to work site)	0.2 - 2 ft +
or	
<u>RTK Water Surface Elevation:</u>	
RTK geoid/ellipsoid uncertainty	0.05 - 0.2 ft
RTK accuracy	0.1 - 0.15 ft
<hr/>	

(1) The applicable uncertainties in Table D-1 are statistically propagated to determine the resultant uncertainty of a depth measurement and uncertainty in the dredged clearance estimate.

(2) As an example, given a Gulf Coast 45-ft deep-draft navigation project located 5 miles distant from the reference tide gage. The reference gage datum computation was based on 90 days of observations 30 years ago. The tide readings at the gage are extrapolated out to the project site without any tide range or phase correction. A 1-ft swell exists at the staff gage and the work site. No heave-pitch-roll correction is applied. The mean tide range is 8 ft at the offshore project site and 6 ft at the gage. The phase lag between the project site and gage is estimated at 45 minutes. The TPU of the measured grade would be estimated as follows:

<u>Estimated Uncertainty Factor in TPU</u> [Visual Tide Gage Observations]	<u>Uncertainty in ± ft (95%)</u>
Tidal gage MLLW datum accuracy	0.2 ft (NOAA estimate)
Tidal epoch latency (update lag)	0.05 ft (1993 to 2009)

Tide staff setting accuracy	0.02 ft (leveling)
Tide staff visual resolution	0.05 ft (gage observer)
Extrapolated (projected) surface from gage:	
MLLW range gradient	0.2 ft (unmodeled MLLW reference)
Tidal phase lag (average ebb/flood)	0.7 ft (average random deviations)
Heave-pitch-roll	0.3 ft
Draft	0.05 ft
Acoustic depth measurement	0.3 ft (from above table)

Total Propagated Uncertainty: 0.9 ft RMS (95%)

(3) If the above example project is modified to use RTK for determining the water surface elevation, VDatum is used to establish the offshore datum, and an inertial-aided heave-pitch-roll system is used, the above TPU estimate will be reduced as follows:

<u>Estimated Uncertainty Factor in TPU</u> [RTK Tide Observations]	<u>Uncertainty in ± ft (95%)</u>
Tidal gage MLLW datum accuracy	0.2 ft (NOAA estimate)
Tidal epoch latency (update lag)	0.05 ft (1993 to 2009)
Tide staff setting accuracy	0.02 ft (leveling)
Tide staff visual resolution	0.05 ft (RTK calibration)
Extrapolated (projected) surface RTK:	
RTK resolution	0.15 ft
Lever arm measurements	0.1 ft
MLLW range gradient	0.01 ft (VDatum modeled MLLW)
Tidal phase lag (average ebb/flood)	0.0 ft (average random deviations)
Heave-pitch-roll (IMU)	0.05 ft
Draft	0.05 ft
Acoustic depth measurement	0.3 ft (from above table)
<u>Total Propagated Uncertainty:</u>	<u>0.4 ft</u> RMS (95%)

b. Approximate estimates of uncertainties in deep-draft navigation projects. Table D-2 provides another example of some general estimates for survey uncertainties under nominal deep-draft project conditions, accounting for various measurement conditions largely dependent on the water surface measurement correction. These ranges may be used to estimate the TPU for a specific navigation project. Given the main variable in the table is dependent on the gage location relative to the project site (non-RTK measurements) the magnitude of this uncertainty needs to be estimated based on actual tidal range and phase conditions.

Table D-2. Estimated TPU Allowances for Deep-Draft Navigation Projects.
(From EM 1110-2-5056)

Typical TPU	Water Surface Elevation Measurement Procedure	Tidal regime hydrodynamically modeled
<u>Hard Bottom Materials</u>		
± 0.20 ft	Determined from carrier phase GPS (RTK)	Yes
± 0.25 ft	Determined from carrier phase GPS (RTK)	No
± 0.20 ft	Estimated from gage less than 1 mile from project site	Yes
± 0.25 ft to ± 0.50 ft	Estimated from gage 1 to 5 miles from project site	No
± 0.50 ft to ± 1.0 ft	Estimated from gage > 5 miles from project site	No
± 0.50 ft to ± 2.0 ft	Estimated from gage > 10 miles from project site	No
<u>Soft Bottom Materials (Maintenance Dredging)</u>		
± 0.25 ft	Determined from carrier phase GPS (RTK)	Yes
± 0.25 ft to ± 1.0 ft	Estimated from gage 1 to 10 miles from project site	No
± 0.50 ft to ± 2.0 ft	Highly variable acoustic reflectivity due to suspended sediment, fluff, dense bottom vegetation, etc.	Yes

c. Accuracy of tidal reference datums with Vdatum coverage. Table D-3 (from EM 1110-2-6056) outlines recommended accuracies of reference tide gage datums and the tidal and geoid models at a coastal navigation project site. Uncertainties relative to the NSRS/NWLON are minimized when a specific tide gage and VDatum model are specified for a given navigation project. Details on these relationships are covered in Chapter 4 of EM 1110-2-6056.

Table D-3. Recommended Accuracies for Tidal Reference Datums on Navigation Projects with VDatum Coverage. (From EM 1110-2-6056)

	Accuracy (95%)	Relative to Datum
Absolute accuracy of tidal datum relationship at gage	± 0.25 ft	MLLW Regional NWLON
Relative accuracy of local tidal model	± 0.2 ft	Local MLLW at PPCP Gage
Tidal-geoid model numerical resolution:	nearest 0.01 ft	
Model 1D or 2D density in navigation channel:	100 to 500 ft (varies with tidal range)	
Geoid model:	use latest available at time of study (currently Geoid 09)	
Tidal-geoid model format:	1D or 2D (1D for linear navigation channels)	

NOTE: The above standards are believed representative for most CONUS navigation projects. Exceptions may exist in extreme tide ranges or in parts of Alaska. See VDatum uncertainty models on NOAA VDatum web site.

D-8. Total Propagated Uncertainty Estimates in Superseded Versions of EM 1110-2-1003. The 2002 version of this manual developed an error budget analysis for single-beam depth measurements under various conditions, as shown in Table D-4 below. This analysis was, in effect, a Total Propagated Uncertainty estimate. (The term "TPU" was not used back in 2002.) This error budget analysis was used, in part, to develop "mandatory" survey specifications in the 2002 manual. Extracts from those 2002 standards are shown in Table D-5. These 2002 "mandatory" standards, which were developed based on single-beam survey TPU error estimates,

did not account for any significant variations in the project's environmental conditions. These previous standards were, and still are, valid TPU targets, and they do not differ much from the recommended tolerances in Table 3-1; the only difference being the older standards were based on RMS (i.e., TPU) estimates and Table 3-1 is based on Performance Test results.

Table D-4. EM 1110-2-1003 (2002) Single-Beam Uncertainty Estimates.

Quantitative estimate of acoustic depth measurement accuracy in different project conditions

Single-beam 200 kHz echo sounder in soft, flat bottom
USCG DGPS vessel positioning accurate to ± 2 m RMS
All values in \pm feet

Error Budget Source	Inland Navigation	Turning basin	Coastal entrance	Coastal offshore
	Min river slope Staff gage < 0.5 mile 12-ft project <26-ft boat No H-P-R	2 ft tide range Gage < 1 mile 26-ft project <26-ft boat No H-P-R	4-ft tide range Gage < 2 mile 43-ft project <26-ft boat No H-P-R	8-ft tide range Gage > 5 mile 43-ft project 65-ft boat H-P-R corm
Measurement system accuracy	0.05	0.05	0.1	0.2
Velocity calibration accuracy	0.05	0.1	0.1	0.15
Sounder resolution	0.1	0.1	0.1	0.1
Draft/index accuracy	0.05	0.1	0.1	0.1
Tide/stage correction accuracy	0.1	0.15	0.25	0.5
Platform stability error	0.05	0.2	0.3	0.25
Vessel velocity error	0.05	0.1	0.1	0.15
Bottom reflectivity/sensitivity	0.05	0.1	0.1	0.2
RMS (95%)	± 0.37 ft	± 0.66 ft ± 0.90 ft	± 1.32 ft	
Allowed (2002 Standards)	± 0.5 ft	± 1.0 ft	± 1.0 ft	± 2.0 ft

a. The above uncertainty estimate attempted to assign error components under various (but limited—only four) "average" or "typical" project conditions. It does illustrate the complexity in estimating depth uncertainty (TPU) for any specific project. Items such as "tide/stage correction" and "bottom reflectivity characteristics" are highly subjective. In addition, the above analysis did not include any multibeam system uncertainties.

b. The RMS (TPU) estimates in Table D-4 were factored into the "mandatory" accuracy standards specified back in 2002 (Table D-5). No allowance was made for "non-average" project conditions; however, the 2002 version did note that "... it is fully recognized that exceptions to these standards will exist for some applications, or as technological advances occur ..." As stated in Chapter 3, some of the criteria in Table D-5 do not differ significantly from the revised tolerances, QC, and QA procedures in this updated manual.

Table D-5. Superseded EM 1110-2-1003 (2002) Accuracy Standards.

**Minimum Performance Standards for Corps of Engineers Hydrographic Surveys
(Mandatory)**

PROJECT CLASSIFICATION		Navigation & Dredging Support Surveys		Other General Surveys & Studies (Recommended Standards)
		Bottom Material Classification		
		Hard	Soft	
RESULTANT ELEVATION/DEPTH ACCURACY (95%)				
<u>System</u>	<u>Depth (d)</u>			
Mechanical	(d<15 ft)	± 0.25 ft	± 0.25 ft	± 0.5 ft
Acoustic	(d<15 ft)	± 0.5 ft	± 0.5 ft	± 1.0 ft
Acoustic	(15>d<40 ft)	± 1.0 ft	± 1.0 ft	± 2.0 ft
Acoustic	(d>40 ft)	± 1.0 ft	± 2.0 ft	± 2.0 ft
QUALITY CONTROL & ASSURANCE CRITERIA				
Sound velocity QC calibration		> 2/day	2/day	1/day
Position calibration QC check		1/day	1/project	1/project
QA performance test		Mandatory	Required (multibeam)	Optional
Maximum allowable bias		± 0.1 ft	± 0.2 ft	± 0.5 ft

[Note that the "maximum allowable bias" (i.e., repeatability) shown in the 2002 table should not have been indicated as a "±" statistic.]

c. These sections taken from the 2002 manual are intended to illustrate the difficulty in estimating TPUs for surveys, and in defining a uniform Corps-wide "required" accuracy standard, given the variability in survey equipment, methods, and project conditions.

D-9. TPU Calculator. An estimate of the TPU may also be computed using algorithms developed by Rob Hare of the Canadian Hydrographic Service (CHS)—see "Error Budget Analysis for US Naval Oceanographic Office (NAVOCEANO) Hydrographic Survey Systems," NAVOCEANO/Hare 2001. A TPU computation calculator, based on these algorithms, is available in HYPACK software—see HYPACK 2011. A screen capture of this TPU calculator is shown in Figure D-3. This TPU calculator requires user input of the estimated accuracies of over 40 parameters making up the total depth error budget.---far more so than the dozen or so

parameters used in the simplified TPU examples in this appendix. This TPU calculator is applicable to either multibeam or single-beam systems.

Other software acquisition and processing systems (e.g., Caris) can compute TPU estimates for each depth observation, including each depth on a multibeam array. Thus, each observed depth will have a TPU "quality factor" along with its X-Y-Z values. NOAA and its contractors utilize these options on their surveys to determine a most likely representative depth in cells or regions.

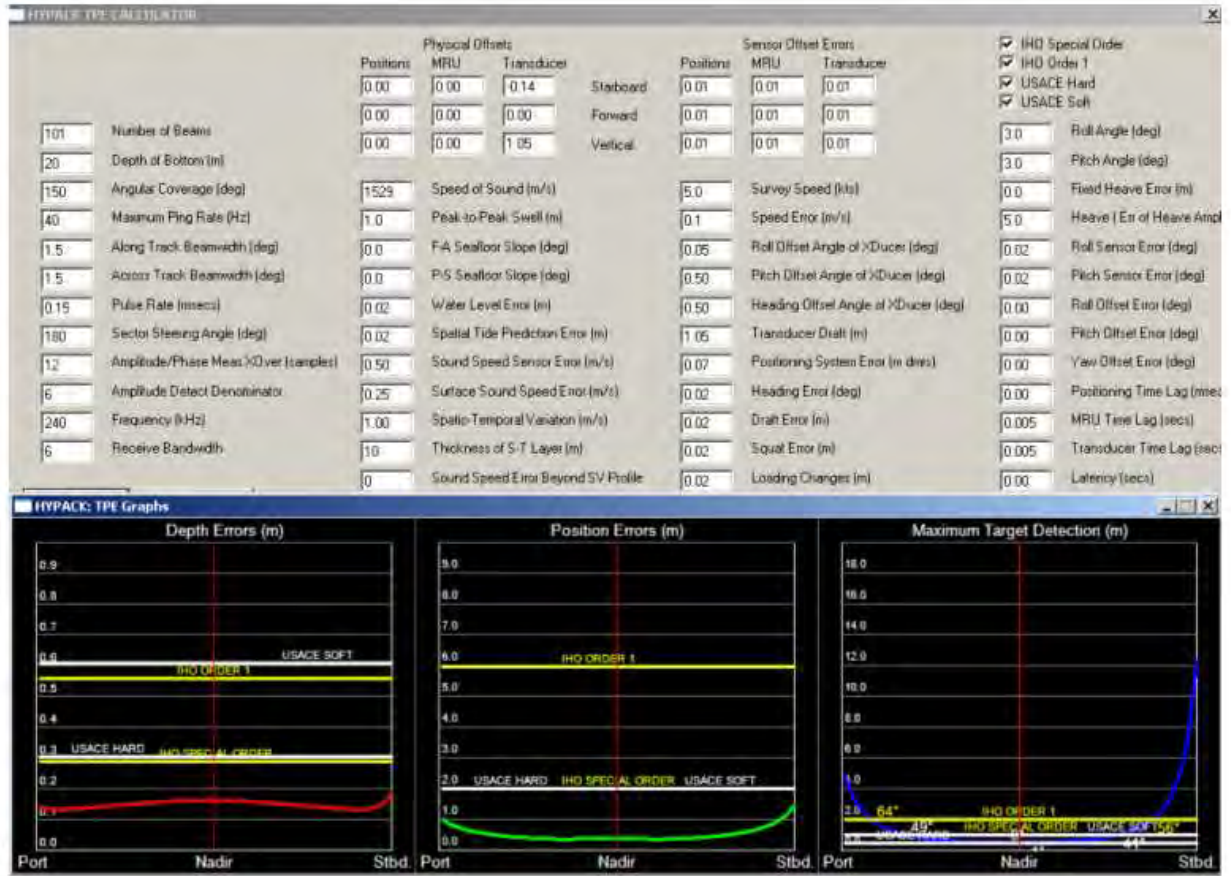

Figure D-3. HYPACK Total Propagated Uncertainty calculator for depth, position, and object detection. Values shown are for example only—users must insert estimated uncertainties for each parameter specific to their survey systems, procedures, and project. (USACE standards shown have been superseded).

APPENDIX E
IHO Standards for Hydrographic Surveys (S-44)

INTERNATIONAL HYDROGRAPHIC ORGANIZATION



IHO STANDARDS FOR HYDROGRAPHIC SURVEYS

5th Edition, February 2008

Special Publication No. 44

**Published by the
International Hydrographic Bureau
MONACO**

© Copyright International Hydrographic Organization [2008]

This work is copyright. Apart from any use permitted in accordance with the Berne Convention for the Protection of Literary and Artistic Works (1886), and except in the circumstances described below, no part may be translated, reproduced by any process, adapted, communicated or commercially exploited without prior written permission from the International Hydrographic Bureau (IHB). Copyright in some of the material in this publication may be owned by another party and permission for the translation and/or reproduction of that material must be obtained from the owner.

This document or partial material from this document may be translated, reproduced or distributed for general information, on no more than a cost recovery basis. Copies may not be sold or distributed for profit or gain without prior written agreement of the IHB and any other copyright holders.

In the event that this document or partial material from this document is reproduced, translated or distributed under the terms described above, the following statements are to be included:

“Material from IHO publication [reference to extract: Title, Edition] is reproduced with the permission of the International Hydrographic Bureau (IHB) (Permission No/...) acting for the International Hydrographic Organization (IHO), which does not accept responsibility for the correctness of the material as reproduced: in case of doubt, the IHO’s authentic text shall prevail. The incorporation of material sourced from IHO shall not be construed as constituting an endorsement by IHO of this product.”

“This [document/publication] is a translation of IHO [document/publication] [name]. The IHO has not checked this translation and therefore takes no responsibility for its accuracy. In case of doubt the source version of [name] in [language] should be consulted.”

The IHO Logo or other identifiers shall not be used in any derived product without prior written permission from the IHB.

INTERNATIONAL HYDROGRAPHIC ORGANIZATION



IHO STANDARDS FOR HYDROGRAPHIC SURVEYS

5th Edition, February 2008

Special Publication No. 44

published by the
International Hydrographic Bureau
4, quai Antoine I^{er}
B.P. 445 - MC 98011 MONACO Cedex
Principauté de Monaco
Tel : (377) 93.10.81.00
Fax : (377) 93.10.81.40
E-mail: info@ihb.mc
Website: www.iho.int

PREFACE

This publication, “Standards for Hydrographic Surveys” (S-44), is one of the series of standards developed by the International Hydrographic Organization (IHO) to help improve the safety of navigation.

Formal discussions on establishing standards for hydrographic surveys began at the VIIth International Hydrographic Conference (IHC) in 1957. Circular Letters to Member States in 1959 and 1962 reported on the views of Member States and the VIIIth IHC in 1962 established a Working Group (WG) comprising 2 members from the USA, 1 from Brazil and 1 from Finland. The WG communicated by mail and held two meetings in conjunction with the IXth IHC in 1967 and prepared the text for Special Publication N^o S-44.

The 1st Edition of S-44 entitled “Accuracy Standards Recommended for Hydrographic Surveys” was published in January 1968 the Foreword to which stated that “...hydrographic surveys were classed as those conducted for the purpose of compiling nautical charts generally used by ships” and “The study confined itself to determining the density and precision of measurements necessary to portray the sea bottom and other *features* sufficiently accurately for navigational purposes.”

Over subsequent years technologies and procedures changed and the IHO established further WGs to update S-44 with the 2nd Edition published in 1982, the 3rd in 1987 and the 4th in 1998. Throughout these revisions the basic objectives of the publication have remained substantially unchanged and this remains so with this 5th Edition.

The Terms of Reference for the WG established to prepare the 5th Edition of S-44 included inter alia: a desire for clearer guidance regarding sea floor *features* and listed a number of concerns including system capabilities for detecting *features* and the characteristics of *features* to be detected. The WG concluded that S-44 sets minimum standards for surveys conducted for the safety of surface navigation. The WG considered it to be the responsibility of each national authority to determine the precise characteristics of *features* to be detected relevant to their organization and to determine the ability of particular systems and their procedures to detect such *features*. The WG further concluded that the design and construction of targets used to demonstrate system detection capabilities is the responsibility of national authorities. The reference to cubic *features* > 1 or 2 metres in size used in these Standards provides a basis for understanding that *features* of at least this size should be detected.

The principal changes made from the 4th Edition are:

The division of Order 1 into 1a where a *full sea floor search* is required and 1b where it is not required. The removal of Order 3 as it was considered that there was no longer a need to differentiate this from Order 2.

The replacement, in most cases, of the words “[accuracy](#)” and “[error](#)” by “[uncertainty](#)”. [Errors](#) exist and are the differences between the measured value and the true value. Since the true value is never known it follows that the [error](#) itself cannot be known. [Uncertainty](#) is a statistical assessment of the likely magnitude of this [error](#). This terminology is increasingly being used in measurement: see ISO/IEC 98: 1995 “Guide to the expression of uncertainty in measurement” (due to be updated in 2008) and ISO/IEC 99:2007 “International Vocabulary of Metrology – Basic and general concepts and associated terms (VIM).

The Glossary has been updated and some terms which the WG consider fundamental to the understanding of these Standards are repeated in the Introduction.

The WG considered that information on “How to Survey” was not appropriate to these Standards and this information has been removed from the 5th Edition. However the WG acknowledges the usefulness of this guidance and the information has been retained in two annexes. The WG recommends that this information should be transferred to IHO Publication M-13 (Manual on Hydrography) at which time the annexes should be removed from S-44.

A minimum spot spacing for bathymetric LIDAR has been included in [Table 1](#) for Order 1b surveys where [full sea floor search](#) is not required.

Finally it was the view of the WG that S-44 provides “Standards for Hydrographic Surveys” and that it is the responsibility of individual Hydrographic Offices / Organizations to prepare “Specifications” based on these Standards. Specifications will be more system specific and as such will be quite dynamic as systems change.

INTRODUCTION

This publication is designed to provide a set of standards for the execution of hydrographic surveys for the collection of data which will primarily be used to compile navigational charts to be used for the safety of surface navigation and the protection of the marine environment.

It must be realised that this publication only provides the **minimum** standards that are to be achieved. Where the bathymetry and expected shipping use requires it, hydrographic offices / organisations wishing to gather data may need to define more stringent standards. Also, this publication does not contain procedures for setting up the necessary equipment, for conducting the survey or for processing the resultant data. These procedures (which are a fundamental part of the complete survey system) must be developed by the hydrographic office/organisation wishing to gather data that is compliant with these Standards. Consideration must be made of the order of survey they wish to achieve, the equipment they have at their disposal and the type of topography that they intend to survey. Annexes A and B provide guidelines for [Quality control](#) and Data Processing and it is intended that these will be moved to the Manual on Hydrography (IHO Publication M-13) which provides further guidance on how to perform hydrographic surveys.

There is nothing to stop users adopting these Standards for other uses. Indeed, such a broadening of the use of these Standards is welcomed. However, users who wish to adopt

these for other means must bear in mind the reason why they were written and therefore accept that not all parts may be suitable for their specific needs.

To be compliant with an S-44 Order a survey must be compliant with ALL specifications for that order included in these Standards.

It is also important to note that the adequacy of a survey is the end product of the entire survey system and processes used during its collection. The [uncertainties](#) quoted in the following chapters reflect the total propagated [uncertainties](#) of all parts of the system. Simply using a piece of equipment that is theoretically capable of meeting the required [uncertainty](#) is not necessarily sufficient to meet the requirements of these Standards. How the equipment is set up, used and how it interacts with the other components in the complete survey system must all be taken into consideration.

All components **and their combination** must be capable of providing data to the required standard. The hydrographic office / organisation needs to satisfy itself that this is so by, for example, conducting appropriate trials with the equipment to be used and by ensuring that adequate calibrations are performed prior to, as well as during and, if appropriate, after the survey being carried out. The surveyor is an essential component of the survey process and must possess sufficient knowledge and experience to be able to operate the system to the required standard. Measuring this can be difficult although surveying qualifications (e.g. having passed an IHO Cat A/B recognised hydrographic surveying course) may be of considerable benefit in making this assessment.

It should be noted that the issue of this new edition to the standard does not invalidate surveys, or the charts and nautical publications based on them, conducted in accordance with previous editions, but rather sets the standards for future data collection to better respond to user needs.

It should also be noted that where the sea floor is dynamic (e.g. sand waves), surveys conducted to any of the Orders in these Standards will quickly become outdated. Such areas need to be resurveyed at regular intervals to ensure that the survey data remains valid. The intervals between these resurveys, which will depend on the local conditions, should be determined by national authorities.

A [glossary](#) of terms used in this publication is given after Chapter 6. Terms included in the glossary are shown in the text in italic type and in the electronic version are hyperlinked to their definition. The following “Fundamental Definitions” from the glossary are considered essential to the understanding of these Standards.

FUNDAMENTAL DEFINITIONS

Feature detection: The ability of a system to detect [features](#) of a defined size. These Standards specify the size of [features](#) which, for safety of navigation, should be detected during the survey.

Full sea floor search: A systematic method of exploring the sea floor undertaken to detect most of the features specified in Table 1; utilising adequate detection systems, procedures and trained personnel. In practice, it is impossible to achieve 100% ensonification / 100% bathymetric coverage (the use of such terms should be discouraged).

Reduced depths: Observed depths including all corrections related to the survey and post processing and reduction to the used vertical datum.

Total horizontal uncertainty (THU): The component of total propagated uncertainty (TPU) calculated in the horizontal plane. Although THU is quoted as a single figure, THU is a 2 Dimensional quantity. The assumption has been made that the uncertainty is isotropic (i.e. there is negligible correlation between errors in latitude and longitude). This makes a Normal distribution circularly symmetric allowing a single number to describe the radial distribution of errors about the true value.

Total propagated uncertainty (TPU): the result of uncertainty propagation, when all contributing measurement uncertainties, both random and systematic, have been included in the propagation. Uncertainty propagation combines the effects of measurement uncertainties from several sources upon the uncertainties of derived or calculated parameters.

Total vertical uncertainty (TVU): The component of total propagated uncertainty (TPU) calculated in the vertical dimension. TVU is a 1 Dimensional quantity.

CHAPTER 1 – CLASSIFICATION OF SURVEYS

Introduction

This chapter describes the orders of survey that are considered acceptable to allow hydrographic offices / organizations to produce navigational products that will allow the expected shipping to navigate safely across the areas surveyed. Because the requirements vary with water depth and expected shipping types, four different orders of survey are defined; each designed to cater for a range of needs.

The four orders are described below along with an indication of the need that the order is expected to meet. Table 1 specifies the minimum standards for each of these orders and **must** be read in conjunction with the detailed text in the following chapters.

The agency responsible for acquiring surveys should select the order of survey that is most appropriate to the requirements of safe navigation in the area. It should be noted that a single order may not be appropriate for the entire area to be surveyed and, in these cases, the agency responsible for acquiring the survey should explicitly define where the different orders are to be used. It should also be noted that the situation discovered in the field by the surveyor may differ sufficiently enough from what was expected to warrant a change of order. For instance in an area traversed by Very Large Crude Carriers (VLCCs) and expected to be deeper than 40 metres an Order 1a survey may have been specified; however if the surveyor discovers

shoals extending to less than 40 metres then it may be more appropriate to survey these shoals to Special Order.

Special Order

This is the most rigorous of the orders and its use is intended only for those areas where under-keel clearance is critical. Because under-keel clearance is critical a [full sea floor search](#) is required and the size of the [features](#) to be detected by this search is deliberately kept small. Since under-keel clearance is critical it is considered unlikely that Special Order surveys will be conducted in waters deeper than 40 metres. Examples of areas that may warrant Special Order surveys are: berthing areas, harbours and critical areas of shipping channels.

Order 1a

This order is intended for those areas where the sea is sufficiently shallow to allow natural or man-made [features](#) on the seabed to be a concern to the type of surface shipping expected to transit the area but where the under-keel clearance is less critical than for Special Order above. Because man-made or natural [features](#) may exist that are of concern to surface shipping, a [full sea floor search](#) is required, however the size of the [feature](#) to be detected is larger than for Special Order. Under-keel clearance becomes less critical as depth increases so the size of the [feature](#) to be detected by the [full sea floor search](#) is increased in areas where the water depth is greater than 40 metres. Order 1a surveys may be limited to water shallower than 100 metres.

Order 1b

This order is intended for areas shallower than 100 metres where a general depiction of the seabed is considered adequate for the type of surface shipping expected to transit the area. A [full sea floor search](#) is not required which means some [features](#) may be missed although the maximum permissible line spacing will limit the size of the [features](#) that are likely to remain undetected. This order of survey is only recommended where under-keel clearance is not considered to be an issue. An example would be an area where the seabed characteristics are such that the likelihood of there being a man-made or natural [feature](#) on the sea floor that will endanger the type of surface vessel expected to navigate the area is low.

Order 2

This is the least stringent order and is intended for those areas where the depth of water is such that a general depiction of the seabed is considered adequate. A [full sea floor search](#) is not required. It is recommended that Order 2 surveys are limited to areas deeper than 100 metres as once the water depth exceeds 100 metres the existence of man-made or natural [features](#) that are large enough to impact on surface navigation and yet still remain undetected by an Order 2 survey is considered to be unlikely.

CHAPTER 2 – POSITIONING

2.1 Horizontal Uncertainty

The uncertainty of a position is the uncertainty at the position of the sounding or feature within the geodetic reference frame.

Positions should be referenced to a geocentric reference frame based on the International Terrestrial Reference System (ITRS) e.g. WGS84. If, exceptionally, positions are referenced to the local horizontal datum, this datum should be tied to a geocentric reference frame based on ITRF.

The uncertainty of a position is affected by many different parameters; the contributions of all such parameters to the total horizontal uncertainty (THU) should be accounted for.

A statistical method, combining all uncertainty sources, for determining positioning uncertainty should be adopted. The position uncertainty at the 95% confidence level should be recorded together with the survey data (see also 5.3). The capability of the survey system should be demonstrated by the THU calculation.

The position of soundings, dangers, other significant submerged features, nav aids (fixed and floating), features significant to navigation, the coastline and topographical features should be determined such that the horizontal uncertainty meets the requirements specified in Table 1. This includes all uncertainty sources not just those associated with positioning equipment.

CHAPTER 3 – DEPTHS

3.1 Introduction

The navigation of vessels requires accurate knowledge of the water depth in order to exploit safely the maximum cargo carrying capacity, and the maximum available water for safe navigation. Where under-keel clearances are an issue the depth uncertainties must be more tightly controlled and better understood. In a similar way, the sizes of features that the survey will have or, more importantly, may not have detected, should also be defined and understood.

The measured depths and drying heights shall be referenced to a vertical datum that is compatible with the products to be made or updated from the survey e.g. chart datum. Ideally this sounding datum should also be a well defined vertical datum such as, LAT, MSL, a geocentric reference frame based on ITRS or a geodetic reference level.

3.2 Vertical Uncertainty

Vertical uncertainty is to be understood as the uncertainty of the reduced depths. In determining the vertical uncertainty the sources of individual uncertainties need to be

quantified. All *uncertainties* should be combined statistically to obtain a [total vertical uncertainty](#) (TVU).

The maximum allowable vertical [uncertainty](#) for [reduced depths](#) as set out in [Table 1](#) specifies the [uncertainties](#) to be achieved to meet each order of survey. [Uncertainty](#) related to the 95% [confidence level](#) refers to the estimation of [error](#) from the combined contribution of random [errors](#) and residuals from the correction of systematic [errors](#). The capability of the survey system should be demonstrated by the TVU calculation.

Recognising that there are both depth independent and depth dependent [errors](#) that affect the [uncertainty](#) of the depths, the formula below is to be used to compute, at the 95% [confidence level](#), the maximum allowable TVU. The parameters “a” and “b” for each order, as given in [Table 1](#), together with the depth “d” have to be introduced into the formula in order to calculate the maximum allowable TVU for a specific depth:

$$\pm \sqrt{a^2 + (b \times d)^2}$$

Where:

- a represents that portion of the [uncertainty](#) that does not vary with depth
- b is a coefficient which represents that portion of the [uncertainty](#) that varies with depth
- d is the depth
- b x d represents that portion of the [uncertainty](#) that varies with depth

The vertical [uncertainty](#) at the 95% [confidence level](#) should be recorded together with the survey data ([see also 5.3](#)).

3.3 Reductions for Tides / Water-level Observations

Observations sufficient to determine variations in the water level across the entire survey area must be taken for the duration of the survey for the reduction of soundings to the relevant [sounding datum](#). These may be determined either by direct measurement of the water level (i.e. by using a gauge) and if necessary carried across the survey area by co-tidal [corrections](#) or by 3D positioning techniques linked to the required [sounding datum](#) by a suitable separation model.

Tidal / water-level reductions need not be applied to depths greater than 200 metres if TVU is not significantly impacted by this approximation.

3.4 Depth measurement

All anomalous [features](#) previously reported in the survey area and those detected during the survey should be examined in greater detail and, if confirmed, their position and least depth determined. If a previously reported anomalous [feature](#) is not detected refer to [Chapter 6](#) for

disproving requirements. The agency responsible for survey quality may define a depth limit beyond which a detailed sea floor investigation, and thus an examination of anomalous [features](#), is not required.

For wrecks and obstructions which may have less than 40 metres clearance above them and may be dangerous to normal surface navigation, their position and the least depth over them should be determined by the best available method while meeting the depth [uncertainty](#) standard **of the appropriate order** in [Table 1](#).

Side scan sonar should not be used for depth measurement but to define areas requiring more detailed and accurate investigation.

3.5 Feature detection

When a [full sea floor search](#) is required, the equipment used to conduct the survey must be demonstrably capable of detecting [features](#) of the dimensions specified in [Table 1](#). Additionally, the equipment must be considered as part of a system (includes survey / processing equipment, procedures and personnel) that will ensure there is a high probability that these [features](#) will be detected. It is the responsibility of the hydrographic office / organisation that is gathering the data to assess the capability of any proposed system and so satisfy themselves that it is able to detect a sufficiently high proportion of any such [features](#).

The Special Order and Order 1a [feature detection](#) requirements of 1 metre and 2 metre cubes respectively are minimum requirements. [Features](#) may exist that are smaller than the size mandated for a given order but which are a hazard to navigation. It may therefore be deemed necessary by the hydrographic office / organization to detect smaller [features](#) in order to minimise the risk of undetected hazards to surface navigation.

It should be noted that even when surveying with a suitable system 100% detection of [features](#) can never be guaranteed. If there is concern that [features](#) may exist within an area that may not be detected by the Survey System being used, consideration should be given to the use of an alternative system (e.g. a mechanical sweep) to increase the confidence in the minimum safe clearance depth across the area.

3.6 Sounding Density / Line Spacing

In planning the density of soundings, both the nature of the seabed in the area and the requirements of safe surface navigation have to be taken into account to ensure an adequate [sea floor search](#).

For Special Order and Order 1a surveys no recommended maximum line spacing is given as there is an overriding requirement for [full sea floor search](#).

[Full sea floor search](#) is not required for Orders 1b and 2 and [Table 1](#) recommends maximum line spacing (Orders 1b and 2) and bathymetric LIDAR spot density (Order 1b). The nature of the seabed needs to be assessed as early as possible in a survey in order to decide whether the line spacing / LIDAR spot density from [Table 1](#) should be reduced or extended.

CHAPTER 4 - OTHER MEASUREMENTS

4.1 Introduction

The following observations may not always be necessary but if specified in the survey requirement should meet the following standards.

4.2 Seabed Sampling

The nature of the seabed should be determined in potential anchorage areas; it may be determined by physical sampling or inferred from other sensors (e.g. single beam echo sounders, side scan sonar, sub-bottom profiler, video, etc.). Physical samples should be gathered at a spacing dependent on the seabed geology and as required to ground truth any inference technique.

4.3 Chart and Land Survey Vertical Datums Connection

IHO Technical Resolution A2.5, as set out in IHO Publication M-3, requires that the datum used for tidal predictions should be the same as that used for chart datum. In order for the bathymetric data to be fully exploited the vertical datum used for tidal observations should be connected to the general land survey datum via prominent fixed marks in the vicinity of the tide gauge/station/observatory. Ellipsoidal height determinations of the vertical reference marks used for tidal observations should be made relative to a geocentric reference frame based on ITRS, preferably WGS84, or to an appropriate geodetic reference level.

4.4 Tidal Predictions

Tidal data may be required for analysis for the future prediction of tidal heights and the production of Tide Tables in which case observations should cover as long a period of time as possible and preferably not less than 30 days.

4.5 Tidal Stream and Current Observations

The speed and direction of tidal streams and currents which may exceed 0.5 knot should be observed at the entrances to harbours and channels, at any change in direction of a channel, in anchorages and adjacent to wharf areas. It is also desirable to measure coastal and offshore streams and currents when they are of sufficient strength to affect surface navigation.

The tidal stream and current at each position should be measured at depths sufficient to meet the requirements of normal surface navigation in the survey area. In the case of tidal streams, simultaneous observations of tidal height and meteorological conditions should be made and the period of observation should ideally be 30 days.

The speed and direction of the tidal stream and current should be measured to 0.1 knot and the nearest 10° respectively, at 95% [*confidence level*](#).

Where there is reason to believe that seasonal river discharge influences the tidal streams and currents, measurements should be made to cover the entire period of variability.

CHAPTER 5 – DATA ATTRIBUTION

5.1 Introduction

To allow a comprehensive assessment of the quality of survey data it is necessary to record or document certain information together with the survey data. Such information is important to allow exploitation of survey data by a variety of users with different requirements, especially as requirements may not be known when the survey data is collected.

5.2 Metadata

Metadata should be comprehensive but should comprise, as a minimum, information on:

- the survey in general e.g. purpose, date, area, equipment used, name of survey platform;
- the geodetic reference system used, i.e. horizontal and vertical datum including ties to a geodetic reference frame based on ITRS (e.g. WGS84) if a local datum is used;
- calibration procedures and results;
- sound speed correction method;
- tidal datum and reduction;
- uncertainties achieved and the respective confidence levels;
- any special or exceptional circumstances;
- rules and mechanisms employed for data thinning.

Metadata should preferably be an integral part of the digital survey record and conform to the “IHO S-100 Discovery Metadata Standard”, when this is adopted. Prior to the adoption of S-100, ISO 19115 can be used as a model for the metadata. If this is not feasible similar information should be included in the documentation of a survey.

Agencies responsible for the survey quality should develop and document a list of metadata used for their survey data.

5.3 Point Data Attribution

All data should be attributed with its uncertainty estimate at the 95% confidence level for both position and, if relevant, depth. The computed or assumed scale factor applied to the standard deviation in order to determine the uncertainty at the 95% confidence level, and/or the assumed statistical distribution of errors should be recorded in the survey’s metadata. (For example, assuming a Normal distribution for a 1 Dimensional quantity, such as depth, the scale factor is 1.96 for 95% confidence. A statement such as “Uncertainties have been computed at 95% confidence assuming a standard deviation scale factor of 1.96 (1D) or 2.45 (2D), corresponding to the assumption of a Normal distribution of errors,” would be

adequate in the [metadata](#).) For soundings this should preferably be done for each individual sounding; however a single [uncertainty](#) estimate may be recorded for a number of soundings or even for an area, provided the difference between the individual [uncertainty](#) estimates and the collectively assigned [uncertainty](#) estimate is negligible. The attribution should, as a minimum, be sufficient to demonstrate that the requirements of these Standards have been met.

5.4 Bathymetric Model Attribution

If a [Bathymetric Model](#) is required, [metadata](#) should include: the model resolution; the computation method; the underlying data density; [uncertainty](#) estimate/[uncertainty surface](#) for the model; and a description of the underlying data.

5.5 Report of Survey

The Report of Survey is the principal means by which the Surveyor in Charge approves the contents of all survey records. It must give a clear and comprehensive account of how the survey was carried out, the results achieved, the difficulties encountered and the shortcomings. Emphasis should be placed on the analysis of achieved accuracies and whether the survey specifications have been met.

CHAPTER 6 - ELIMINATION OF DOUBTFUL DATA

6.1 Introduction

To improve the safety of navigation it is desirable to eliminate doubtful data, i.e. data which are usually denoted on charts by PA (Position Approximate), PD (Position Doubtful), ED (Existence Doubtful), SD (Sounding Doubtful) or as "reported danger". To confirm or disprove the existence of such data it is necessary to carefully define the area to be searched and subsequently survey that area according to the standards outlined in this publication.

6.2 Extent of Area to be Searched

No empirical formula for defining the search area can cover all situations. For this reason, it is recommended that the search radius should be at least 3 times the estimated position [uncertainty](#) of the reported hazard at the 95% [confidence level](#) as determined by a thorough investigation of the report on the doubtful data by a qualified hydrographic surveyor.

If such report is incomplete or does not exist at all, the position [uncertainty](#) must be estimated by other means as, for example, a more general assessment of positioning and depth measurement [uncertainties](#) during the era when the data in question was collected.

6.3 Conducting the Search

The methodology for conducting the search should be based on the nature of the *feature*, the area in which the doubtful data is reported and the estimated danger of the potential hazard to surface navigation. Once this has been established, the search procedure should be that of conducting a hydrographic survey of the extent defined in 6.2, to the standards established in this publication.

6.4 Presentation of Search Results

Doubtful data shall be replaced with actual data collected during the search if the hazard has been detected. If not detected, the agency responsible for the survey quality shall decide whether to retain the hazard as charted or to delete it.

TABLE 1 Minimum Standards for Hydrographic Surveys *(To be read in conjunction with the full text set out in this document.)*

Reference	Order	Special	1a	1b	2
Chapter 1	Description of areas.	Areas where under-keel clearance is critical	Areas shallower than 100 metres where under-keel clearance is less critical but <i>features</i> of concern to surface shipping may exist.	Areas shallower than 100 metres where under-keel clearance is not considered to be an issue for the type of surface shipping expected to transit the area.	Areas generally deeper than 100 metres where a general description of the sea floor is considered adequate.
Chapter 2	Maximum allowable THU 95% Confidence level	2 metres	5 metres + 5% of depth	5 metres + 5% of depth	20 metres + 10% of depth
Para 3.2 and note 1	Maximum allowable TVU 95% Confidence level	a = 0.25 metre b = 0.0075	a = 0.5 metre b = 0.013	a = 0.5 metre b = 0.013	a = 1.0 metre b = 0.023
Glossary and note 2	<u>Full Sea floor Search</u>	Required	Required	Not required	Not required
Para 2.1 Para 3.4 Para 3.5 and note 3	<u>Feature Detection</u>	Cubic <i>features</i> > 1 metre	Cubic <i>features</i> > 2 metres, in depths up to 40 metres; 10% of depth beyond 40 metres	Not Applicable	Not Applicable
Para 3.6 and note 4	Recommended maximum Line Spacing	Not defined as <i>full sea floor search</i> is required	Not defined as <i>full sea floor search</i> is required	3 x average depth or 25 metres, whichever is greater For bathymetric lidar a spot spacing of 5 x 5 metres	4 x average depth
Chapter 2 and note 5	Positioning of fixed aids to navigation and topography significant to navigation. (95% Confidence level)	2 metres	2 metres	2 metres	5 metres
Chapter 2 and note 5	Positioning of the Coastline and topography less significant to navigation (95% Confidence level)	10 metres	20 metres	20 metres	20 metres
Chapter 2	Mean position of floating	10 metres	10 metres	10 metres	20 metres

Reference	Order	Special	1a	1b	2
and note 5	aids to navigation (95% Confidence level)				

Notes:

- 1: Recognising that there are both constant and depth dependent [uncertainties](#) that affect the [uncertainty](#) of the depths, the formula below is to be used to compute, at the 95% [confidence level](#), the maximum allowable TVU. The parameters “a” and “b” for each Order, as given in the Table, together with the depth “d” have to be introduced into the formula in order to calculate the maximum allowable TVU for a specific depth:

$$\pm \sqrt{a^2 + (b \times d)^2}$$

Where:

- a represents that portion of the [uncertainty](#) that does not vary with depth
- b is a coefficient which represents that portion of the [uncertainty](#) that varies with depth
- d is the depth
- b x d represents that portion of the [uncertainty](#) that varies with depth

- 2: For safety of navigation purposes, the use of an accurately specified mechanical sweep to guarantee a minimum safe clearance depth throughout an area may be considered sufficient for Special Order and Order 1a surveys.
- 3: A cubic [feature](#) means a regular cube each side of which has the same length. It should be noted that the IHO Special Order and Order 1a [feature detection](#) requirements of 1 metre and 2 metre cubes respectively, are minimum requirements. In certain circumstances it may be deemed necessary by the hydrographic offices / organizations to detect smaller [features](#) to minimise the risk of undetected hazards to surface navigation. For Order 1a the relaxing of [feature detection](#) criteria at 40 metres reflects the maximum expected draught of vessels.
- 4: The line spacing can be expanded if procedures for ensuring an adequate sounding density are used. "Maximum Line Spacing" is to be interpreted as the:
- Spacing of sounding lines for single beam echo sounders, or the

EM 1110-2-1003
30 Nov 13

- Distance between the useable outer limits of swaths for swath systems.

5: These only apply where such measurements are required for the survey.

GLOSSARY

Note: The terms defined below are those that are most relevant to this publication. A much larger selection of terms are defined in IHO Special Publication S-32 (Hydrographic Dictionary) and this should be consulted if the required term is not listed here. If a term listed below has a different definition in S-32, the definition given below should be used in relation to these standards.

Accuracy: The extent to which a measured or enumerated value agrees with the assumed or accepted value (see: [uncertainty](#), [error](#)).

Bathymetric Model: A digital representation of the topography (bathymetry) of the sea floor by coordinates and depths.

Blunder: The result of carelessness or a mistake; may be detected through repetition of the measurement.

Confidence interval: See [uncertainty](#).

Confidence level: The probability that the true value of a measurement will lie within the specified [uncertainty](#) from the measured value. It must be noted that confidence levels (e.g. 95%) depend on the assumed statistical distribution of the data and are calculated differently for 1 Dimensional (1D) and 2 Dimensional (2D) quantities. In the context of this standard, which assumes Normal distribution of [error](#), the 95% confidence level for 1D quantities (e.g. depth) is defined as 1.96 x standard deviation and the 95% confidence level for 2D quantities (e.g. position) is defined as 2.45 x standard deviation.

Correction: A quantity which is applied to an observation or function thereof, to diminish or minimise the effects of [errors](#) and obtain an improved value of the observation or function. It is also applied to reduce an observation to some arbitrary standard. The correction corresponding to a given computed [error](#) is of the same magnitude but of opposite sign.

Error: The difference between an observed or computed value of a quantity and the true value of that quantity. (NB The true value can never be known, therefore the true error can never be known. It is legitimate to talk about error sources, but the values obtained from what has become known as an error budget, and from an analysis of residuals, are [uncertainty](#) estimates, not errors. See [uncertainty](#).)

Feature: in the context of this standard, any object, whether manmade or not, projecting above the sea floor, which may be a danger for surface navigation.

Feature detection: The ability of a system to detect [features](#) of a defined size. These Standards specify the size of [features](#) which, for safety of navigation, should be detected during the survey.

Full sea floor search: A systematic method of exploring the sea floor undertaken to detect most of the [features](#) specified in Table 1; utilising adequate detection systems, procedures

and trained personnel. In practice, it is impossible to achieve 100% ensonification / 100% bathymetric coverage (the use of such terms should be discouraged).

Integrity monitor: Equipment consisting of a GNSS receiver and radio transmitter set up over a known survey point that is used to monitor the quality of a Differential GNSS (DGNSS) signal. Positional discrepancies are continuously monitored and timely warnings are transmitted to users indicating when the system should not be used.

Integrity monitoring: This is the ability of a system to provide timely warnings to users when the system should not be used.

Metadata: Information describing characteristics of data, e.g. the [uncertainty](#) of survey data. ISO definition: Data (describing) about a data set and usage aspect of it. Metadata is data implicitly attached to a collection of data. Examples of metadata include overall quality, data set title, source, positional uncertainty and copyright.

Quality assurance: All those planned and systematic actions necessary to provide adequate confidence that a product or a service will satisfy given requirements for quality.

Quality control: All procedures which ensure that the product meets certain standards and specifications.

Reduced depths: Observed depths including all [corrections](#) related to the survey and post processing and reduction to the used vertical datum.

Sea floor search: A systematic method of exploring the sea floor in order to detect [features](#) such as wrecks, rocks and other obstructions on the sea floor.

Sounding datum: The vertical datum to which the soundings on a hydrographic survey are reduced. Also called 'datum' for sounding reduction.

Total horizontal uncertainty (THU): The component of [total propagated uncertainty](#) (TPU) calculated in the horizontal plane. Although THU is quoted as a single figure, THU is a 2 Dimensional quantity. The assumption has been made that the [uncertainty](#) is isotropic (i.e. there is negligible correlation between [errors](#) in latitude and longitude). This makes a Normal distribution circularly symmetric allowing a single number to describe the radial distribution of [errors](#) about the true value.

Total propagated uncertainty (TPU): the result of [uncertainty](#) propagation, when all contributing measurement [uncertainties](#), both random and systematic, have been included in the propagation. [Uncertainty](#) propagation combines the effects of measurement [uncertainties](#) from several sources upon the [uncertainties](#) of derived or calculated parameters.

Total vertical uncertainty (TVU): The component of [total propagated uncertainty](#) (TPU) calculated in the vertical dimension. TVU is a 1 Dimensional quantity.

Uncertainty: The interval (about a given value) that will contain the true value of the measurement at a specific [confidence level](#). The [confidence level](#) of the interval and the assumed statistical distribution of [errors](#) must also be quoted. In the context of this standard the terms uncertainty and [confidence interval](#) are equivalent.

Uncertainty Surface: A model, typically grid based, which describes the depth [uncertainty](#) of the product of a survey over a contiguous area of the skin of the earth. The uncertainty surface should retain sufficient [metadata](#) to describe unambiguously the nature of the [uncertainty](#) being described.

ANNEX A

GUIDELINES FOR QUALITY CONTROL

NOTE: it should be noted that the information contained in Annexes A and B provide some guidance on [quality control](#) and data processing. These Annexes are **not** an integral part of the S-44 Standards and will be removed when the information therein is fully incorporated into IHO Publication M-13.

A.1 Introduction

To ensure that the required [uncertainties](#) are achieved it is necessary to monitor performance. Compliance with the criteria specified in this document has to be demonstrated.

Standard calibration techniques should be completed prior to and after the acquisition of data and after any major system modification takes place.

Establishing [quality control](#) procedures should be a high priority for hydrographic offices / organizations. These procedures should cover the entire system including navigation sensors, data collection and processing equipment and the operators. All equipment should be confirmed as functioning within its calibration values and the system should be assessed to ensure that the relevant [uncertainties](#) in [Table 1](#) can be met. Other parameters, e.g. vessel motion and speed, which can affect the quality of the collected data, should also be monitored.

The processing procedures used prior to the introduction of Multi Beam, Echo Sounders (MBES) and bathymetric LIDAR systems are inefficient, in terms of both manpower and the time required to process the high volume of data gathered by these systems. Processing procedures are needed that allow the reduction, processing and production of the final data set within acceptable manpower and time constraints while maintaining data integrity. As hydrographic offices / organizations continue to be responsible (liable) for their products, these processing procedures should be well documented.

The original survey data (raw data from the different sensors) should be conserved adequately before commencing with the processing of data. The final processed data set should also be conserved. The long-term storage of data, in this era of rapidly changing electronic systems, needs careful planning, execution and monitoring.

Each office is responsible for the definition of its long-term conservation policy for both raw and processed data sets.

A.2 Positioning

Integrity monitoring for Special Order and Order 1a/b surveys is recommended. When equipment is installed to determine or improve the positioning of survey platforms (e.g. Global Navigational Satellite Systems (GNSS) corrections), the uncertainty of the equipment position relative to the horizontal datum must be included in the calculation of THU.

A.3 Depth Data Integrity

Check lines or overlapping swaths indicate the level of agreeability or repeatability of measurements but do not indicate absolute accuracy in that there are numerous sources of potential common errors (see A.4) between data from main lines and check lines. The quality control procedure should include statistical analysis of differences and the consideration of common errors to provide an indication of compliance of the survey with the standards given in Table 1. The effect of spikes and blunders should be eliminated prior to this analysis. Remaining anomalous differences should be further examined with a systematic analysis of contributing uncertainty sources. All discrepancies should be resolved, either by analysis or re-survey during progression of the survey task.

The ability to compare surfaces generated from newly collected data to those generated from historical information can often be useful in validating the quality of the new information, or alternatively, for notifying the collecting agency of an unresolved systematic uncertainty that requires immediate attention.

A.3.1 Single-beam Echo Sounders (SBES)

Check lines should be run at discrete intervals. These intervals should not normally be more than 15 times the spacing of the main sounding lines.

A.3.2 Swath Echo Sounders

An appropriate assessment of the uncertainty of the depths at each incidence angle (within each beam for a MBES) should be made. If any of the depths have unacceptable uncertainties, the related data should be excluded. A number of check lines should be run. Where adjacent swaths have a significant overlap the spacing between check lines may be extended.

A.3.3 Sweep Systems (multi-transducer arrays)

It is essential that the distance between individual transducers and the acoustic area of ensonification should be matched to the depths being measured to ensure full sea floor coverage across the measurement swath. A number of check lines should be run.

Vertical movements of booms must be monitored carefully as the sea state increases, especially where the effects of heave on the transducers are not directly measured (e.g. decoupled booms systems). Once the heave on the transducers exceeds the maximum allowable value in the [uncertainty](#) budget, sounding operations should be discontinued until sea conditions improve.

A.3.4 Bathymetric LIDAR

Hazards to navigation detected by bathymetric LIDAR should be examined using a bathymetric system capable of determining the shallowest point according to the standards set out in this document. A number of check lines should be run.

A.4 Error Sources

Although the following text focuses on [errors](#) in data acquired with swath systems, it should be noted that it is in principle applicable to data acquired with any depth measurement system.

With swath systems the distance between the sounding on the sea floor and the positioning system antenna can be very large, especially in deep water. Because of this, sounding position [uncertainty](#) is a function of the [errors](#) in vessel heading, beam angle and the water depth.

Roll and pitch [errors](#) will also contribute to the [uncertainty](#) in the positions of soundings. Overall, it may be very difficult to determine the position [uncertainty](#) for each sounding as a function of depth. The [uncertainties](#) are a function not only of the swath system but also of the location of, offsets to and accuracies of the auxiliary sensors.

The use of non-vertical beams introduces additional [uncertainties](#) caused by incorrect knowledge of the ship's orientation at the time of transmission and reception of sonar echoes. [Uncertainties](#) associated with the development of the position of an individual beam must include the following:

- a) Positioning system [errors](#);
- b) Range and beam [errors](#);
- c) The error associated with the ray path model (including the sound speed profile), and the beam pointing angle;
- d) The error in vessel heading;
- e) System pointing [errors](#) resulting from transducer misalignment;
- f) Sensor location;
- g) Vessel motion sensor [errors](#) i.e. roll and pitch;
- h) Sensor position offset [errors](#); and
- i) Time synchronisation / latency.

Contributing factors to the vertical [uncertainty](#) include:

- a) Vertical datum [errors](#);

- b) Vertical positioning system *errors*;
- c) Tidal measurement *errors*, including co-tidal *errors* where appropriate;
- d) Instrument *errors*;
- e) Sound speed *errors*;
- f) Ellipsoidal / vertical datum separation model *errors*;
- g) Vessel motion *errors*, i.e. roll, pitch and heave;
- h) Vessel draught;
- i) Vessel settlement and squat;
- j) Sea floor slope; and
- k) Time synchronisation / latency.

Agencies responsible for the survey quality are encouraged to develop *uncertainty* budgets for their own systems.

A.5 Propagation of Uncertainties

TPU is a combination of random and bias based *uncertainties*. Random and short period *uncertainties* have to be recognised and evaluated both in horizontal and vertical directions.

The propagated *uncertainty* may be expressed as a variance (in meters²) but is more often reported as an *uncertainty* (in meters) derived from variance with the assumption that the *uncertainty* follows a known distribution. In the latter case, the level of confidence (e.g., “at 95% *confidence level*”) and the assumed distribution shall be documented. Horizontal *uncertainties* are generally expressed as a single value at a 95% level, implying an isotropic distribution of *uncertainty* on the horizontal plane.

In the hydrographic survey process it is necessary to model certain long period or constant factors related to the physical environment (e.g. tides, sound speed, dynamics, squat of the survey vessel). Inadequate models may lead to bias type *uncertainties* in the survey results. These *uncertainties* shall be evaluated separately from random type *uncertainties*.

TPU is the resultant of these two main *uncertainties*. The conservative way of calculating the result is the arithmetic sum, although users should be aware that this may significantly overestimate the total *uncertainty*. Most practitioners, and the appropriate ISO standard, recommend quadratic summation (i.e., summation of suitably scaled variances).

ANNEX B

GUIDELINES FOR DATA PROCESSING

NOTE: it should be noted that the information contained in Annexes A and B provide some guidance on *quality control* and data processing. These Annexes are **not** an integral part of the S-44 Standards and will be removed when the information therein is fully incorporated into IHO Publication M-13.

The text of this annex originates from IHB CL 27/2002 entitled “Guidelines for the processing of high volume bathymetric data” dated 8 August 2002. Sections 2, 3.1 and 4 of

these guidelines have been incorporated into the main body of the 5th Edition of S-44 whilst the remaining sections, with a few amendments, are reproduced below.

B.1 Introduction

The following processing guidelines concentrate on principles and describe **minimum requirements**. The processing steps outlined below are only to be interpreted as an indication, also with regard to their sequence, and are not necessarily exhaustive. Adaptations may be required due to the configuration of the survey as well as the processing system actually used. In general, processing should strive to use all available sources of information to confirm the presence of navigationally significant soundings.

The following workflow should be followed:

B.1.1 Position

This step should comprise merging of positioning data from different sensors (if necessary), qualifying positioning data, and eliminating position jumps. Doubtful data should be flagged and not be deleted.

B.1.2 Depth corrections

Corrections should be applied for water level changes, measurements of motion sensors, and changes of the draught of the survey vessel (e. g. squat changing with speed; change over time caused by fuel consumption). It should be possible to re-process data for which corrections were applied in real-time.

B.1.3 Attitude data

Attitude data (heading, heave, pitch, roll) should be qualified and data jumps be eliminated. Doubtful data should be flagged and not be deleted.

B.1.4 Sound speed correction

Corrections due to two-way travel time and refraction should be calculated and applied during this step. If these corrections have already been applied in real-time during the survey, it should be possible to override them by using another sound speed profile.

B.1.5 System Time Latencies

Time latencies in the survey system may include both constant and variable components. The acquisition system or the processing system should check for latency and remove it whenever practicable.

B.1.6 Merging positions and depths

For this operation the time offset (latency) and the geometric offsets between sensors have to be taken into consideration.

B.1.7 Analysis of returning signal

When a representation of the time series of the amplitude of the returning signal is available, this information may be used to check the validity of soundings.

B.1.8 Automatic (non-interactive) data cleaning

During this stage, the coordinates (i.e. positions and depths) obtained should be controlled automatically by a programme using suitable statistical algorithms which have been documented, tested and demonstrated to produce repeatable and accurate results. When selecting an algorithm, robust estimation techniques should be taken into consideration as their adequacy has been confirmed. Many high-density bathymetry processing packages have built-in statistical processing tools for detecting and displaying outliers. Generally speaking, higher-density data sets with large amounts of overlap between lines provide an increased likelihood of detecting *blunders*. In addition to statistics, threshold values for survey data can be used to facilitate the detection of *blunders*. Each agency is responsible for the validation of the algorithm used and the procedures adopted.

All *blunders* and erroneous and doubtful data should be flagged for subsequent operator control. The type of flag used should indicate that it was set during the automatic stage.

B.1.9 Manual (interactive) data cleaning

Following automated processing procedures, there is a requirement for an experienced and responsible hydrographer to review the automated results and validate those results and/or resolve any remaining ambiguities.

For this stage the use of 3-D visualisation tools is strongly recommended. Decision making about whether to accept or reject apparently spurious soundings can often be enhanced by viewing combined data sets in three dimensions. These tools should allow viewing the data using a zoom facility. The interactive processing system should also offer different display modes for visualisation, e.g. depth plot, *uncertainty* plot, single profile, single beam, backscatter imagery etc. and should allow for the visualisation of the survey data in conjunction with other useful information e.g. shoreline, wrecks, aids to navigation etc. Editing the data should be possible in all modes and include an audit trail. When editing sounding data, it can often be useful to understand the spatial context of the examined data points. What may appear to be bad soundings (*blunders*) out of context may be recognised as real sea floor artefacts (submerged piles, wrecks, etc.) when viewed in the context of a chart backdrop for example. If feasible, data displays should be geo-referenced. The ability to compare surfaces from newly collected data to ones generated from historical information can often be useful in validating the quality of the new information, or alternatively, for notifying the collecting agency of an unresolved systematic *uncertainty* that requires immediate attention.

If feasible, these tools should include the reconciliation of normalised backscatter imagery with bathymetry and, provided that automated object detection tools were used, the display of flagged data for both data modes should be possible.

The rules to be observed by operators during this stage should be documented.

The flags set during the automatic stage, which correspond to depths shallower than the surrounding area, should require explicit operator action, at least, for Special Order and Order 1 a/b surveys. If the operator overrules flags set during the automatic stage, this should be documented. If a flag is set by the operator, the type of flag used should indicate this.

B.2 Use of [uncertainty surfaces](#)

Many statistical bathymetry processing packages also have the ability to generate an [uncertainty surface](#) associated with the bathymetry using either input [error](#) estimates or by generating spatial statistics within grid cells. Displaying and codifying these [uncertainty surfaces](#) is one method of determining whether the entire survey area has met the required specifications. If some areas fall outside the specifications, these areas can be targeted for further data collection or use of alternative systems in order to reduce the [uncertainty](#) to within an acceptable tolerance. When performed in real-time, the sampling strategy can be adapted as the survey progresses, ensuring the collected data are of an acceptable quality for the intended use. Each agency is responsible for the validation of these processing capabilities prior to use.

B.3 Validation Procedures

The final data should be subject to independent in-house validation employing documented [quality control](#) procedures.

EM 1110-2-1003
30 Nov 13

THIS PAGE INTENTIONALLY LEFT BLANK

APPENDIX F

Multibeam Quality Control and Quality Assurance Procedures
(North Atlantic Division Multibeam User Group)

F-1. This appendix contains examples of quality control and quality control criteria used by districts in the North Atlantic Division. Much of the recommended QC and QA guidance in this appendix was developed during periodic North Atlantic Division (NAD) "Multibeam User Group (MUG)" meetings held in the early to mid 2000's in Atlantic City, NJ.

a. Section I contains QC and QA procedural criteria established by the New York District for dredge measurement, payment, and clearance surveys applicable to new work deepening projects in rock cuts.

b. Section II illustrates Philadelphia District Performance Test methods and results on the S/V Shuman's Reson Seabat 8101 multibeam system.

c. Section III describes Patch and Performance Tests on the Philadelphia District S/V Cherneski's Reson 7125 multibeam system.

d. Section IV illustrates a Performance Test between independent survey vessels over a full dredging acceptance section.

e. Section V contains a table of recommended QC and QA practices for multibeam surveys developed during the NAD MUG meetings.

SECTION I

New York District Quality Control and Quality Assurance Requirements for Dredging
Measurement and Payment Surveys

F-2. The following checklist lists minimum QC and QA steps that are performed daily by each survey vessel in New York District. This checklist was especially developed for work on the New York/New Jersey Deepening Project, much of which involved critical contract clearance and acceptance surveys over rock cut channels.

F-3. Definitions:

a. Caven Point" is the New York District Operations Division Marine Terminal in Jersey City—the location of the RTK base station covering navigation projects in the Port of New York

& New Jersey, a Corps-operated water level (tide) gage, and a nearby Performance Test site with a baseline Reference Surface established by multiple survey vessels and survey systems.

b. A “Float Test” is a gage comparison (i.e., "check") with an observed “RTK Tide” while the vessel is dead in the water near the gage.

Multibeam Payment Work QC and QA
(Minimum Required)

Caven Point:

- Check Hardware/System Set-Up
 - Ensure correct INI files are loaded and PPS is functioning correctly
 - Check Orthometric Height
- Measure, Record, and Apply Draft Correction
- Perform Horizontal Calibration Check / Verify Results
- Log Float Test—Caven Point Gage (minimum 60 secs)
- Review and Record Float Test Results
 - (In Stage 1 of the edit, make sure you are looking at where the white line intersects the red line. The red line is the average, but the white line is the value shown on the screen. If there is confusion, go to Stage 2 of the edit and view the tide in the “Sounding Info” screen)
- Start True Heave File

Caven Point Quality Assurance Performance Test Site:

- Perform QC Velocity Cast
- Run multibeam Performance Test “Check Surface”
- Review and Record Performance Test Results
 - (Look at overlapping passes as well as single beam test)
 - (Compare results to current Reference Surface)

Project Site (work area):

- Log Float Test near project reference gage (minimum 60 secs)
 - The Float Test should be conducted in the vicinity of the tide staff. There may be jobs where logging near the staff is not practical; for these jobs you should log as close to the staff as possible. In these circumstances, if you do not match the staff, you must prove out that your tide is correct.
- Review and Record Float Test Results
- Perform QC Velocity Cast

- Perform Ball Check

RUN SURVEY

- Additional Velocity Casts – if sound velocity conditions change such that additional casts are needed
- Perform Final Velocity Cast in work Area
- Perform Final Ball Check
- Log Final Float Test (minimum 60 secs)
- Review and Record Float Test Results

Caven Point Quality Assurance Performance Test Site:

- Perform QC Velocity Cast
- Run multibeam Performance Test “Check Surface”
- Review and Record Performance Test Results
(Look at overlapping passes as well as single beam test)
(Compare results to current Reference Surface)

Caven Point:

- End True Heave File
- Measure and Record Draft Correction
- Log Float Test (Caven Point Gage) (minimum 60 Secs)
- Review and Record Float Test Results

It is the Party Chief’s responsibility to ensure all QC and QA work. If QC or QA checks show results that are not typical, the Party Chief will confer with office personnel to decide if work can proceed.

SECTION II

Performance Tests on S/V Shuman (Philadelphia District)

F-4. This section describes a series of Performance Tests run on the S/V Shuman Reson Seabat 8101 multibeam system in August 2004. A Trimble 4000 DGPS was used for code phase positioning. Vessel motion and alignment was controlled by a TSS MAHRS Gyro/MRU.

30 Nov 13

a. Reference Point and Mounting Offsets. Because the S/V Shuman is a catamaran, using the boat center of gravity (CG) as the reference point causes problems (static roll rotations due to loading that are not about the CG). The MAHRS system has been mounted as near as practical to the sonar and selected as the reference point.

Device	Offset	Starboard	Forward	Vertical	Latency
Trimble 4000	Antenna	-4.3'	0.0'	-15.0'	0.85 S
Seabat 8101	Sonar Head	-4.3'	0.0'	2.7'	0.00 S
TSS MAHRS	Gyro	0.0'	0.0'	0.0'	0.00 S
TSS MAHRS	MRU	0.0'	0.0'	0.0'	0.00 S

b. MRU Roll and Pitch Corrections. To achieve a static value of 0.0 degrees pitch and roll, the following offsets were entered in Hysweep Hardware:

Pitch Offset = 0.85 degrees,

Roll Offset = -0.40 degrees.

Patch Test: Latency Offset = 0.85 s (No patch testing was done for latency because the Trimble 4000 DGPS latency is known to be 0.85 seconds).

Trial 1 = 0.1 degrees, trial 2 = 0.2, trial 3 = 0.1, trial 4 = 0.15

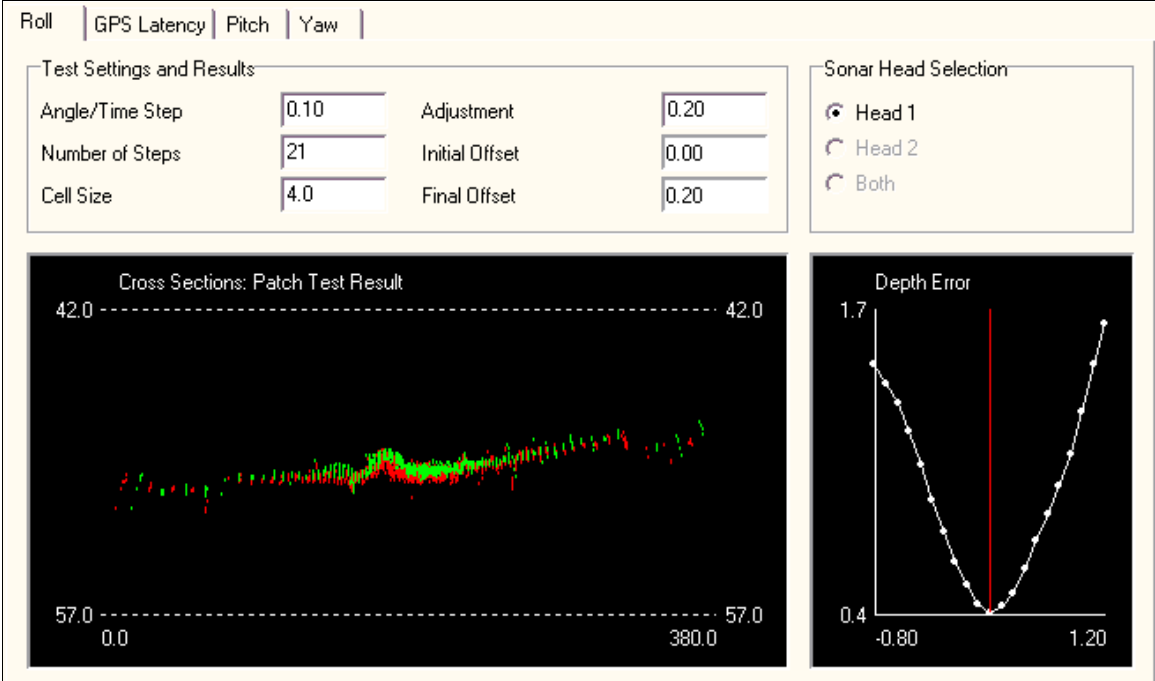

Figure F-1. Preliminary Patch Test: Roll Bias = 0.15 degrees:

Trial 1 = -1.5 degrees, trial 2 = -2.0, trial 3 = -4.0, trial 4 = -1.5

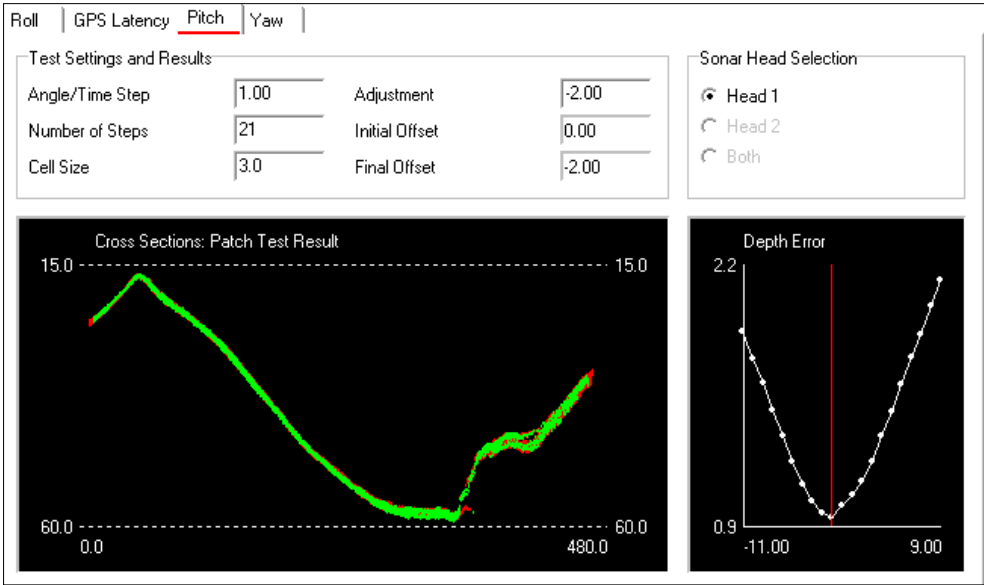

Figure F-2. Preliminary Patch Test: Pitch Bias = -2.0 degrees

:

Trial 1 = 0.0 degrees, trial 2 = 2.0, trial 3 = 2.0, trial 4 = 0.0

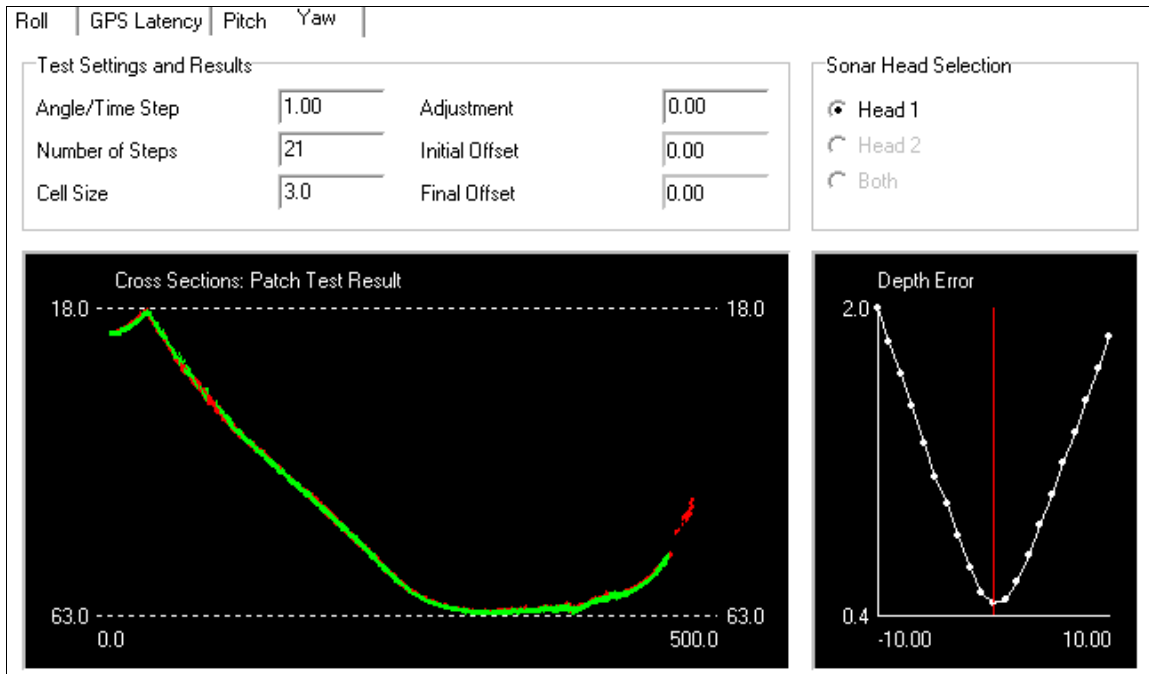

Figure F-3. Preliminary Patch Test: Yaw Bias = 1.0 degrees

Four bar checks were done but the first was thrown out due to a questionable sound velocity profile. Results are with the final Seabat draft constant (vertical offset) of 2.7'

Depth / Direction	Bar Check 2	Bar Check 3	Bar Check 4
20' Down	20.1	19.95	20.1
30' Down	30.0	30.0	29.9
40' Down	40.0	40.05	39.9
30' Up		29.9	30.0
30' Up		20.0	20.0

c. Multibeam Performance Test Results. The survey system is shown to be repeatable to 0.2' at the 95% confidence level (see comparison below). Starting at 45 degrees, a bias is seen between the reference surface and check lines that must be resolved. The most likely cause of the bias is an error in the sound velocity profile. At 45 degrees, all comparisons (Max Outlier, Mean Difference, Std. Deviation and 95% Confidence) fall well within USACE limits for dredging and aid to navigation surveys (see Details tab in the screen shot below).

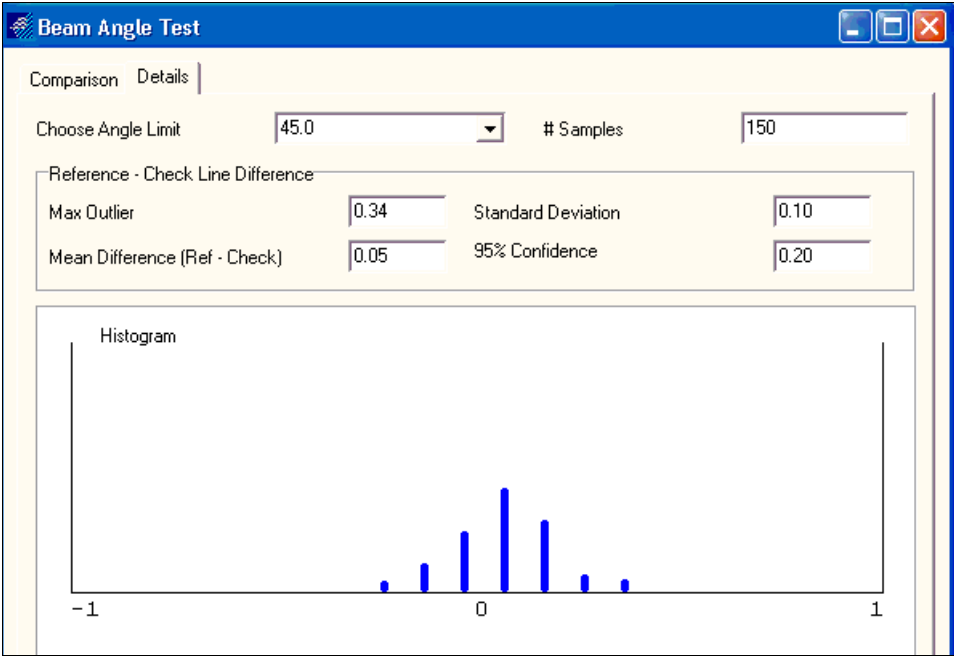

Figure F-4. Multibeam Angle Test

d. Single Beam Comparisons. The Single Beam Test of MBMAX is used to find depth bias between the Shuman multibeam and various single beam systems.

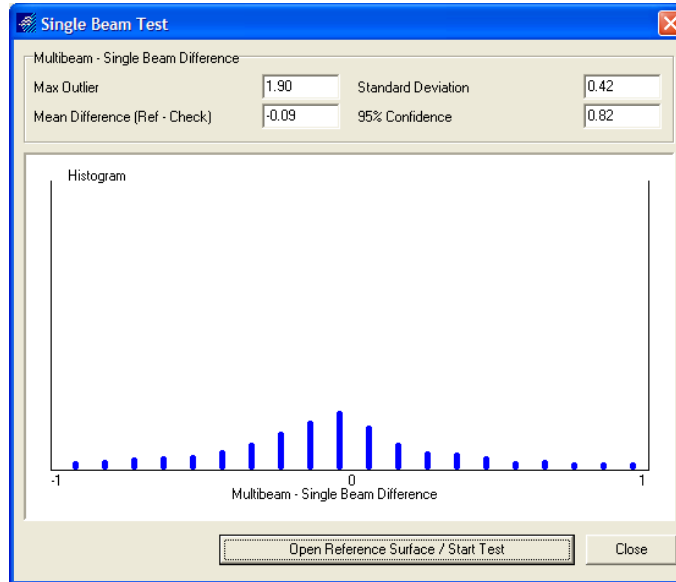

Figure F-5. Shuman Multibeam vs. Shuman Single Beam: Single Beam 0.09' deeper.

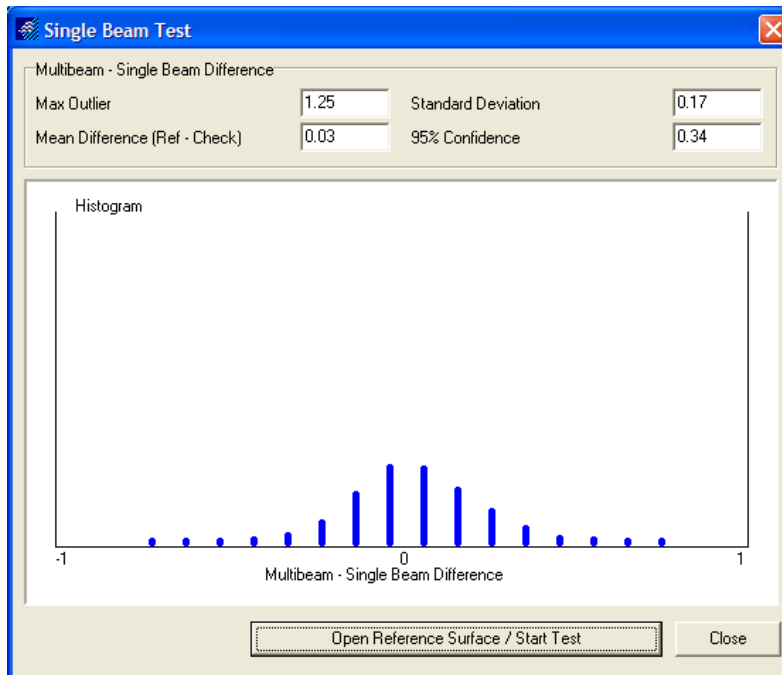

Figure F-6. Shuman Multibeam vs. S/V Cherneski Single Beam: Single beam 0.03' shoaler.

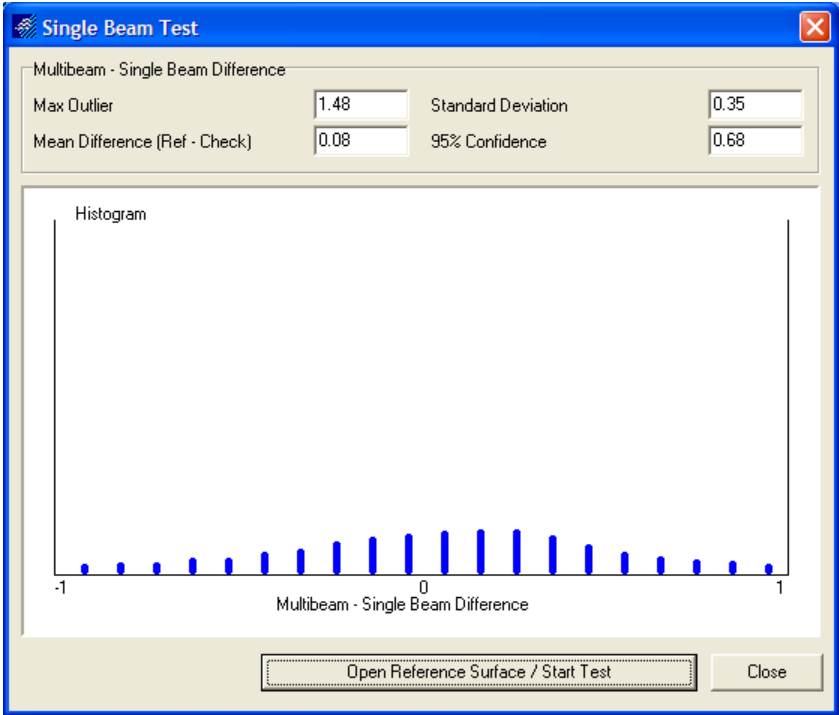

Figure F-7. Shuman Multibeam vs. S/V Essayons Single Beam: Single Beam 0.08 ft shoaler.

SECTION III

Patch / Performance Tests Performed on the S/V Cherneski (Philadelphia District).

F-5. This section is a report on a series of Patch and Performance Tests run on the S/V Cherneski in August 2011. A Reson 7125 multibeam system was combined with an Applanix POS/MV which was used for positioning, vessel motion, and alignment. An SVP 70 was used for sound velocity at the head and an Odom Digibar was used for the sound velocity profile.

Table F-1 Multibeam Calibration

No	Description	Acceptance Criteria	Accepted
2	<p>Determine residual sonar misalignments in roll, pitch and heading. A positioning latency check shall be performed also.</p> <ul style="list-style-type: none"> • Water depth: approx 50 feet for determining misalignment angles. • Seabed type: Flat and steeply sloping • Min 4 Transits, 300 feet length at 6kts for misalignment angles and min 4 transits . • Beam-forming mode: 256 Equi-Distant • Roll Stabilization on 	<ul style="list-style-type: none"> • Sufficient data shall be collected to perform independent calculation of each misalignment twice (min 6 data sets). 	

a. Summary of Patch Test Results

A summary of the accepted patch test results, to be applied for both frequencies, is presented in the following table.

Table F-2 Patch Test Results

Method	Latency	Roll	Pitch	Yaw
Patch Test Results	Zero	-0.11	-0.75	1.38

Following completion of the patch test, the results were applied in the Sonar offsets tab in Hysweep hardware. Initially patch tests were carried out with each frequency; however, results proved to be equivalent.

Table F-3. Sound Velocity Profile Criteria

No	Description	Acceptance Criteria	Accepted
1	Prior to and during all sea acceptance tests a sound velocity profile shall be performed. The sound velocity at the transducer face shall be compared with that from the profiling sound velocity probe at the corresponding depth.	<ul style="list-style-type: none"> The sound velocity measurements shall agree to within 1m/s. 	

b. Sound Velocity Results

The following sound velocity profile was observed using the Odom Digibar prior to the commencement of the calibration and subsequent grid survey. The sound velocity at the transducer depth (approx 2.99ft) was be observed as being 4718 ft/sec (1438m/sec), the SVP 70 at the head read 4717 ft/sec (1437.7 m/sec) . The figure below shows the profile applied for ray tracing on the right and the values read at the sonar on the right.

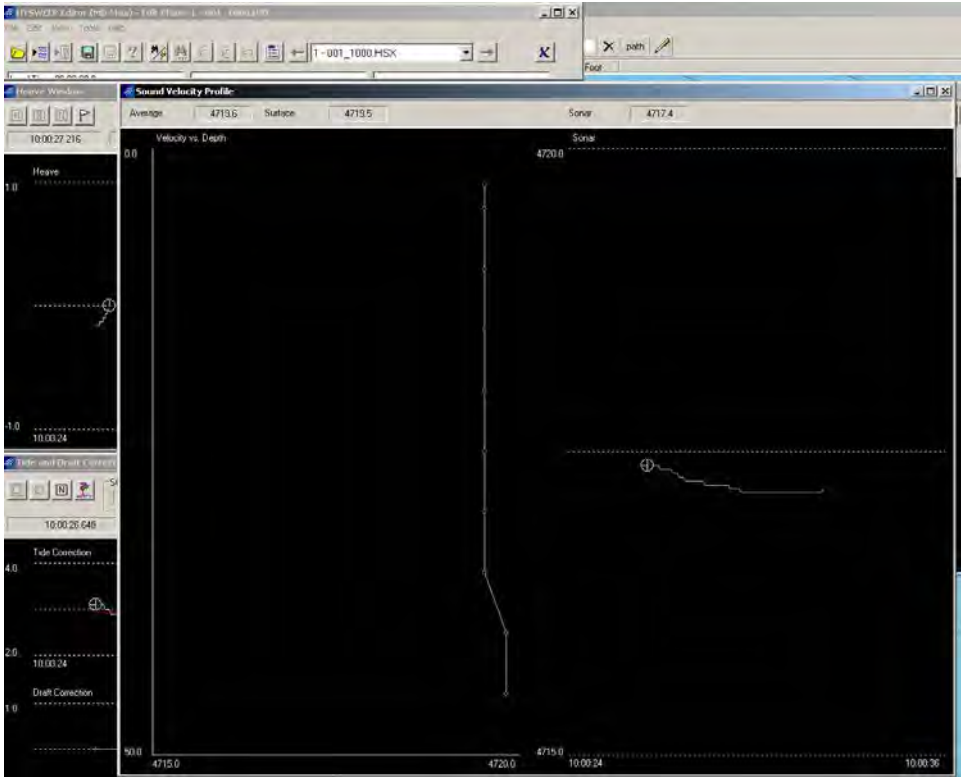

Figure F-8 Sound Velocity Profile

EM 1110-2-1003
30 Nov 13

The profile was used for all data collected as the water column properties did not change for the duration of the tests.

c. Latency Check

The latency checks were carried out over a slope ranging from approximately 50 feet to 33 feet. As shown below a number of tests were carried out and successive values of a latency of zero were calculated.

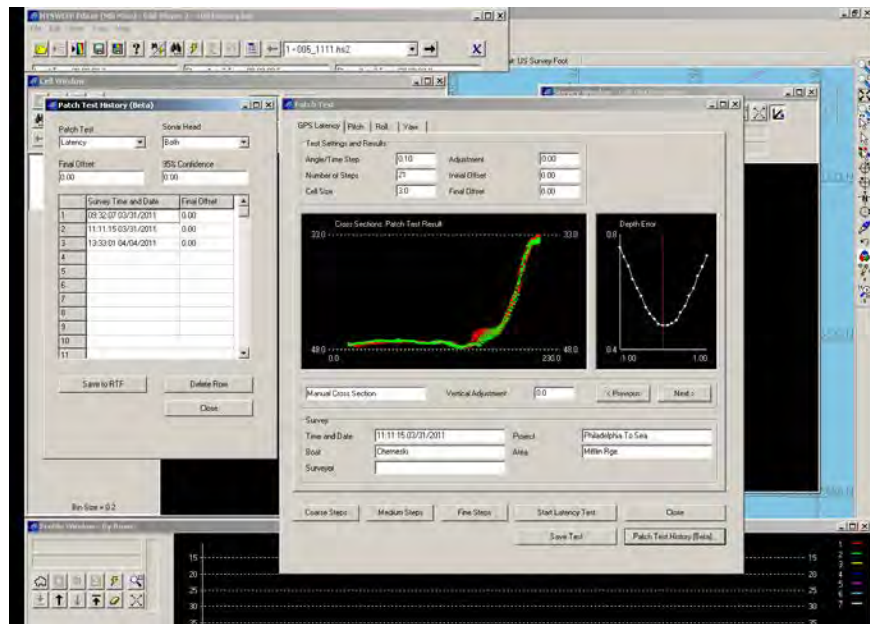

Figure F-9. Latency Check display

Note that the Hypack data acquisition software is synchronized to UTC via the POS MV network time tags. The sonar in turn is synchronized via the ZDA string and 1PPS (Pulse per Second) being issued by the POS MV. RTK positioning was used during these tests to insure data integrity.

c. Roll Calibration

The roll calibration was performed over a flat section of the riverbed at around 50 ft depth, using the same line run in opposite directions. A table of successive roll results was generated and an average of the roll values calculated as to for pitch and yaw.

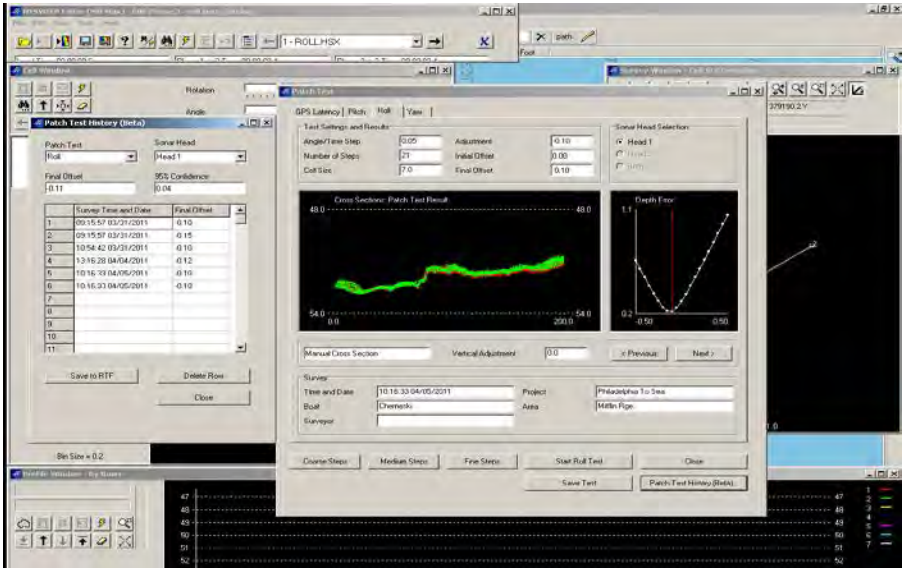

Figure F-10. Roll Calibration Display

d. Pitch Calibration

The pitch calibration was performed using a nadir profile over a slope (the same used for latency), using the same line run in opposite directions.

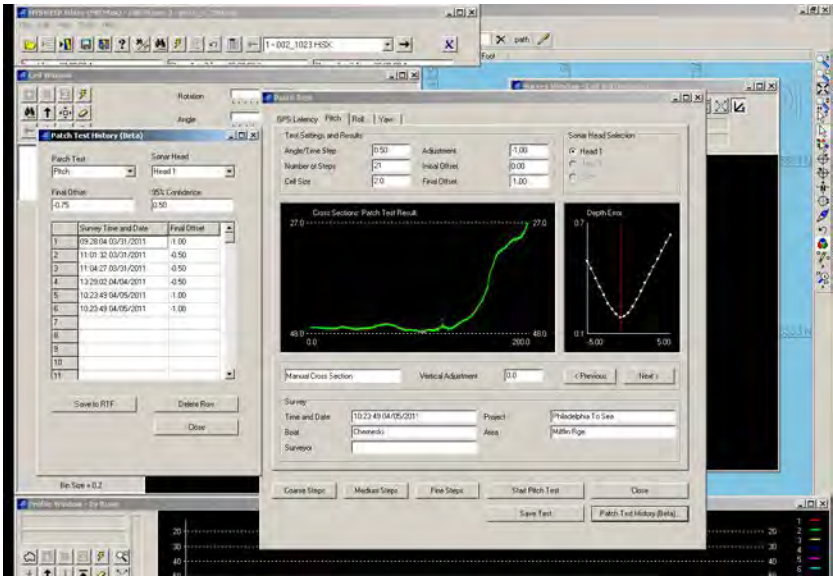

Figure F-11. Pitch Calibration Display

e. Yaw Calibration

The yaw was performed over a profile taken in the overlap region of two adjacent lines over the same slope. The lines were run in the same direction.

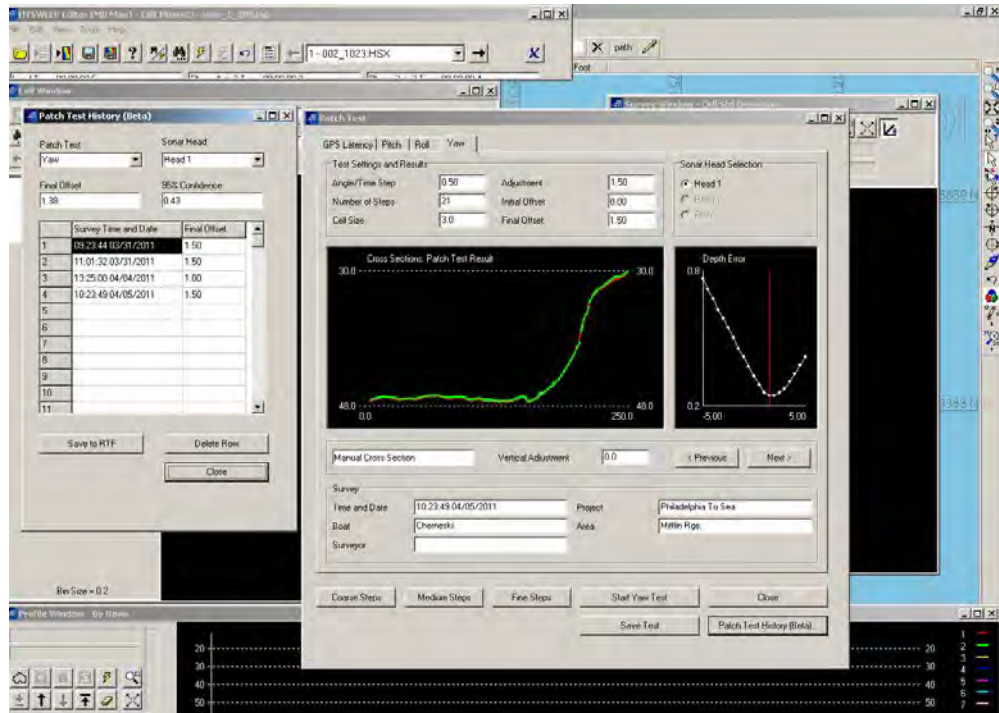

Figure F-12. Yaw Calibration Display

No	Description	Acceptance Criteria	Accepte
3	<p>The Grid Survey shall show that the calibration results are acceptable such that the system is repeatable, independent of direction, with respect to the contracted performance criteria.</p> <ul style="list-style-type: none"> Water depth: approx 50 feet Seabed type: flat A minimum of 3 lines in one direction and 3 three lines over the same area in the perpendicular direction shall be sailed Speed: contracted survey speed. Beam-forming mode: 256 and 512 Equi-Distant (frequency dependent). Roll Stabilization: on 	<ul style="list-style-type: none"> The standard deviation of georeferenced grid cells shall be within the contracted performance criteria. Depth differences between georeferenced grid cells from lines run in perpendicular directions shall be within the contracted performance criteria. 	

Figure F-13. Grid Survey Tests (Performance Tests)

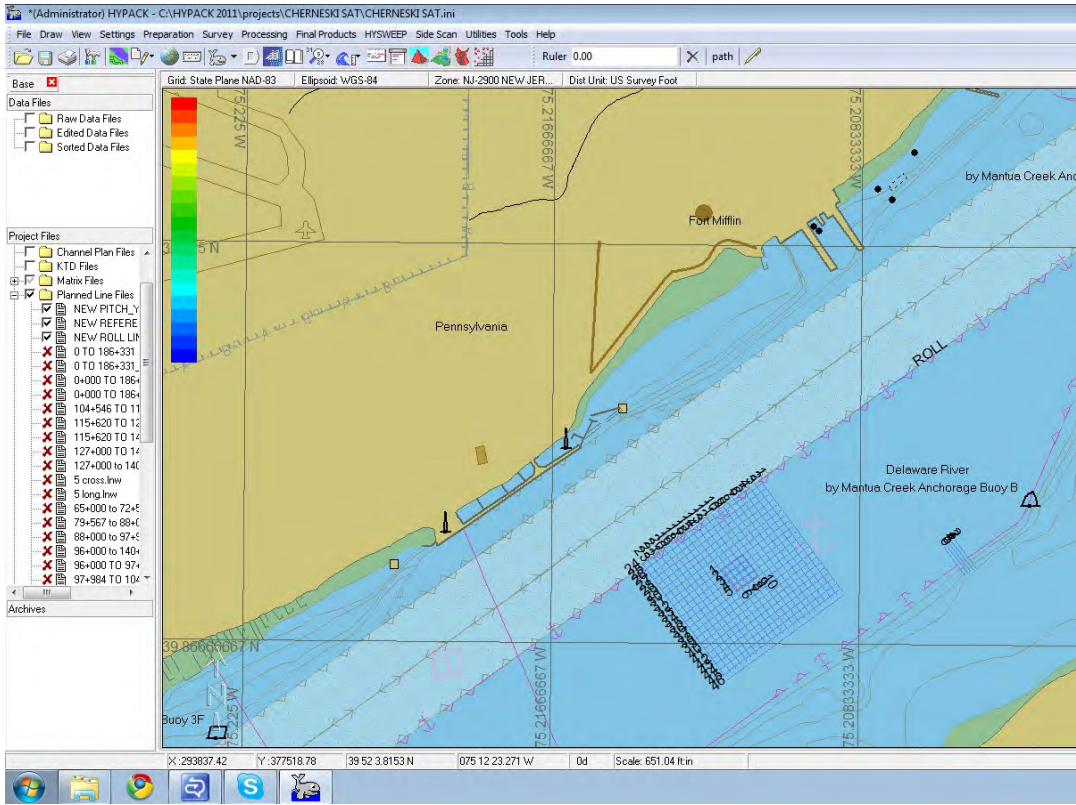

Figure F-14 Performance Test Area

Grid Survey	
Sonar / Mode	SeaBat 7125
Vessel Name	Sv <i>Cherneski</i>
Mounting Method	Hull Mount
Survey Date	2011-04-06
Location	Delaware River, Fort Mifflin.
Area Name	Reference Survey
Speed / Dir	6kts
Comments	Data initially was to be collected within the 1000X1000ft grid shown below. However on consultation a 300X300 ft grid was used (shown within larger grid) consisting of 5 vertical and 5 perpendicular lines. Note: patch test area was directly adjacent to grid area.

Figure F-15. Survey Parameters

EM 1110-2-1003
30 Nov 13

F-6 200 kHz Test

a. Reference Grid.

Grid Survey				
Sonar / Mode	SeaBat 7125 200kHz 256 ED		Depth	50 ft
Vessel Name	<i>Sv Cherneski</i>		Power / Gain / Pulse	220 / 20 / 35
Mounting Method	Hull Mount		TVG Abs / Spr	60 db / 30 db
Survey Date	2011-04-06		Roll Stabilization	On
Location	Delaware River, Fort Mifflin		Swath Sector	90
Area Name	Reference Survey		Cell Size	1ft
Speed / Dir	6kts		Contract Tolerance	0.82 ft (0.25m) IHO Special Order.
Comments	The data example shows the 300X300 ft reference survey area from a total of 10 lines run 5 vertical and 5 perpendicular. The depth variation over the entire area is less .2 feet. Note the overlap of the lines, each shown as a different color at the bottom of the screen. When collecting this data a 45 filter is applied (as per USACE dredge requirements).			

b. Beam Angle Test at 45 deg.

Grid Survey – Beam Angle test at 45				
Sonar / Mode	SeaBat 7125 200kHz 256 ED		Depth	50 ft
Vessel Name	<i>SV Cherneski</i>		Power / Gain / Pulse	220 / 20 / 35
Mounting Method	Hull Mount		TVG Abs / Spr	60 db / 30 db
Survey Date	2011-04-06		Roll Stabilization	On
Location	Delaware River, Fort Mifflin.		Swath Sector	90°
Area Name	Reference Survey		Cell Size	1ft
Speed / Dir	6kts		Contract Tolerance	0.82 ft (0.25m) IHO Special Order.
Comments	The test below shows that when two single crosslines (with 45 port/starboard filters being applied) are compared with the reference surface a mean depth difference of -.02 ft is observed (.006 m).			

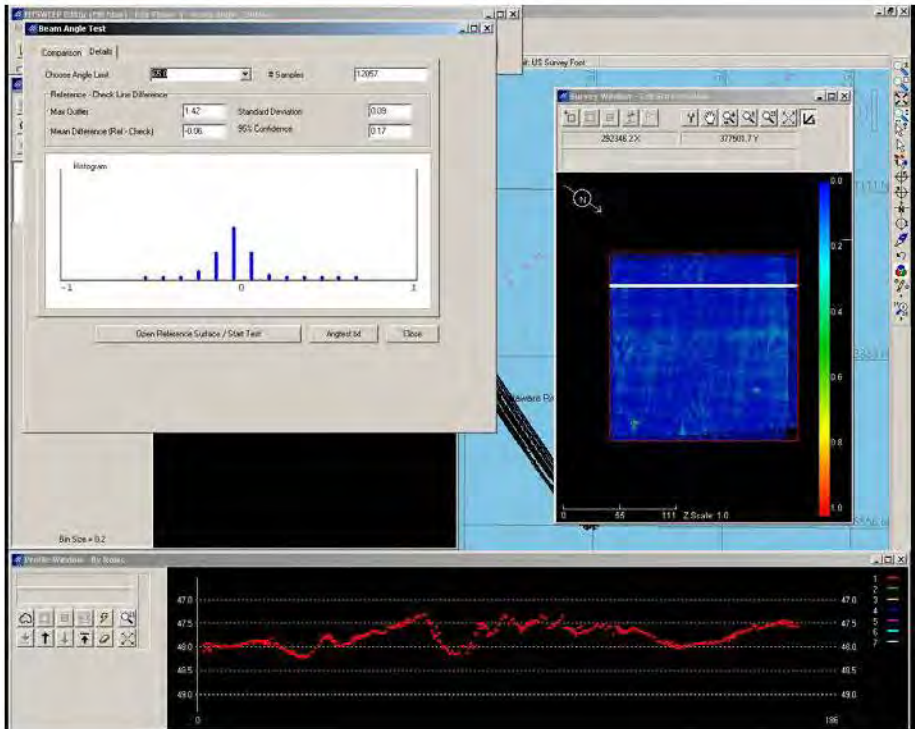
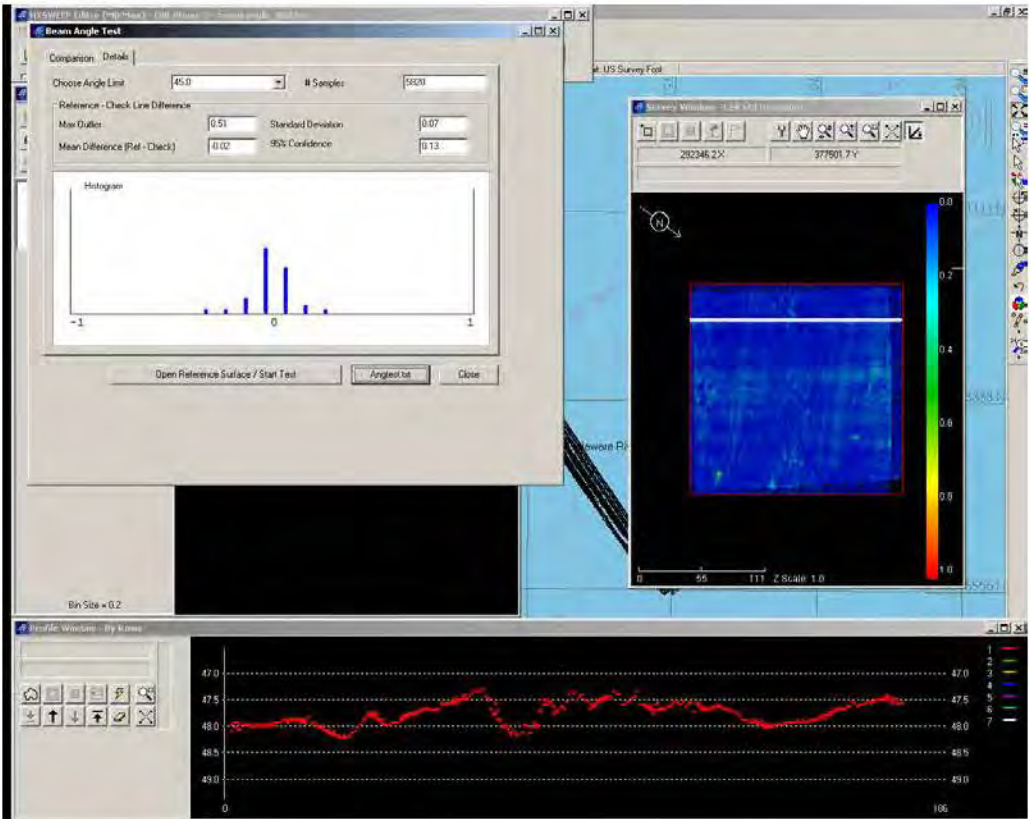

f. Beam Angle Test at full Swath.

Grid Survey – Beam Angle test at full swath.			
Sonar / Mode	SeaBat 7125 200kHz	Depth	50 ft
Vessel Name	SV Cherneski	Power / Gain /	220 / 20 / 35
Mounting	Hull Mount	TVG Abs / Spr	60 db / 30 db
Survey Date	2011-04-06	Roll	On
Location	Delaware River, Fort	Swath Sector	128°
Area Name	Reference Survey	Cell Size	1ft
Speed / Dir	6kts	Contract	0.82 ft (0.25m) IHO Special
Comments	The test below shows that when two single crosslines (with <u>no</u> port/starboard filters being applied i.e. full swath) are compared with the reference surface a mean depth difference		

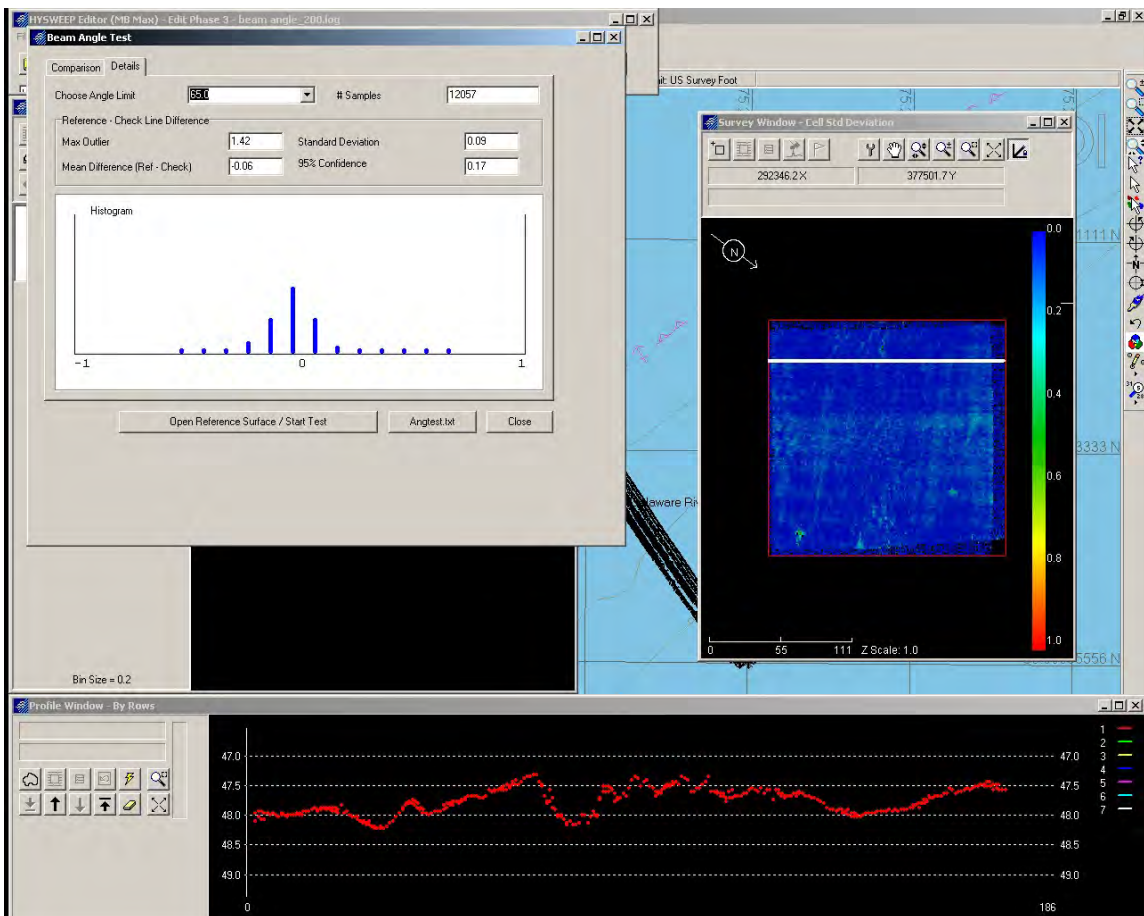

g. Beam Angle Limit Test at 45 deg.

Grid Survey – Beam Angle Limit test at full swath.			
Sonar / Mode	SeaBat 7125 200kHz 256 ED	Depth	50 ft
Vessel Name	SV <i>Cherneski</i>	Power / Gain / Pulse	220 / 20 / 35
Mounting Method	Hull Mount	TVG Abs / Spr	60 db / 30 db
Survey Date	2011-04-06	Roll Stabilization	On
Location	Delaware River, Fort Mifflin.	Swath Sector	128°
Area Name	Reference Survey	Cell Size	1ft
Speed / Dir	6kts	Contract Tolerance	0.82 ft (0.25m) IHO Special Order.
Comments	The test below shows that when two single crosslines (with no port/starboard filters being applied i.e. full swath) are compared with the reference surface a mean depth difference is observed of 0 starting at nadir to approx .05 ft (.015m) at the outermost beam. This is well within the 95% repeatability of between 0.12-0.2 ft.		

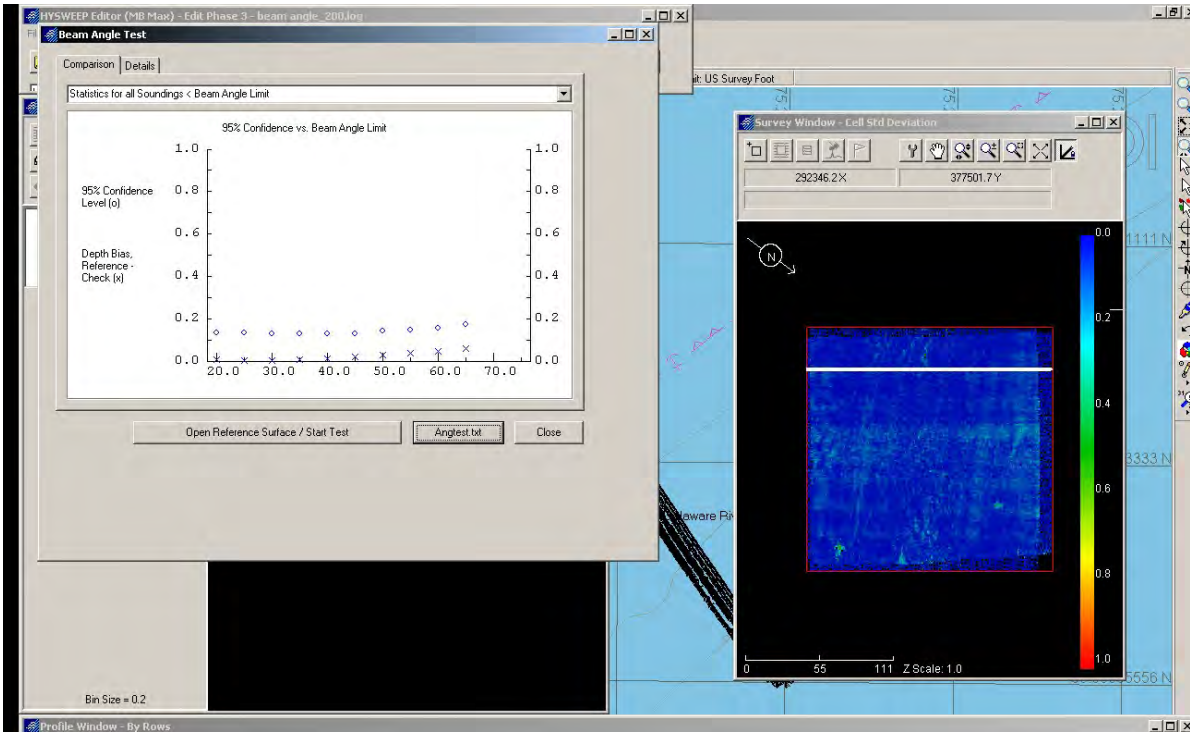

h. Single Beam Comparison.

Grid Survey – Single beam comparison.			
Sonar / Mode	SeaBat 7125 200kHz 256 ED	Depth	50 ft
Vessel Name	SV <i>Cherneski</i>	Power / Gain / Pulse	220 / 20 / 35
Mounting Method	Hull Mount	TVG Abs / Spr	60 db / 30 db
Survey Date	2011-04-06	Roll Stabilization	On
Location	Delaware River, Fort Mifflin.	Swath Sector	90°
Area Name	Reference Survey	Cell Size	1ft
Speed / Dir	6kts	Contract Tolerance	0.82 ft (0.25m) IHO Special Order.
Comments	The test below shows a comparison of cross lines run with a 200kHz single beam with the reference area (as per USACE customer requirements). This shows a mean depth difference of -.05 ft (.015 m)		

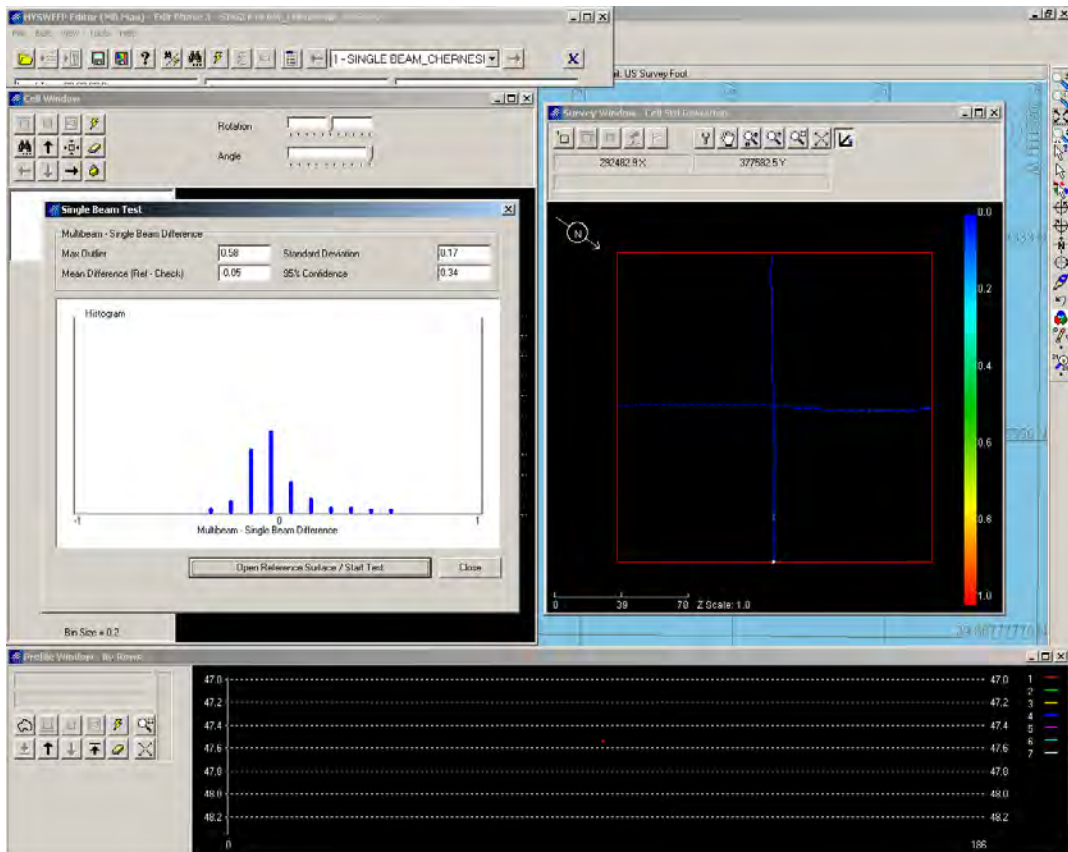

F-7 400 kHz Test

a. Reference Grid.

Grid Survey				
Sonar / Mode	SeaBat 7125 400kHz 512 ED		Depth	50 ft
Vessel Name	<i>SV Cherneski</i>		Power / Gain / Pulse	220 / 20 / 35
Mounting Method	Hull Mount		TVG Abs / Spr	60 db / 30 db
Survey Date	2011-04-06		Roll Stabilization	On
Location	Delaware River, Fort Mifflin.		Swath Sector	90°
Area Name	Reference Survey		Cell Size	1ft
Speed / Dir	6kts		Contract Tolerance	0.82 ft (0.25m) IHO Special Order.
Comments	<p>The data example shows the 300X300 ft reference survey area from a total of 10 lines run 5 vertical and 5 perpendicular. The depth variation over the entire area is less .1 feet.</p> <p>Note the overlap of the lines, each shown as a different color at the bottom of the screen. When collecting this data a 45 filter is applied (as per USACE dredge requirements).</p>			

EM 1110-2-1003
30 Nov 13

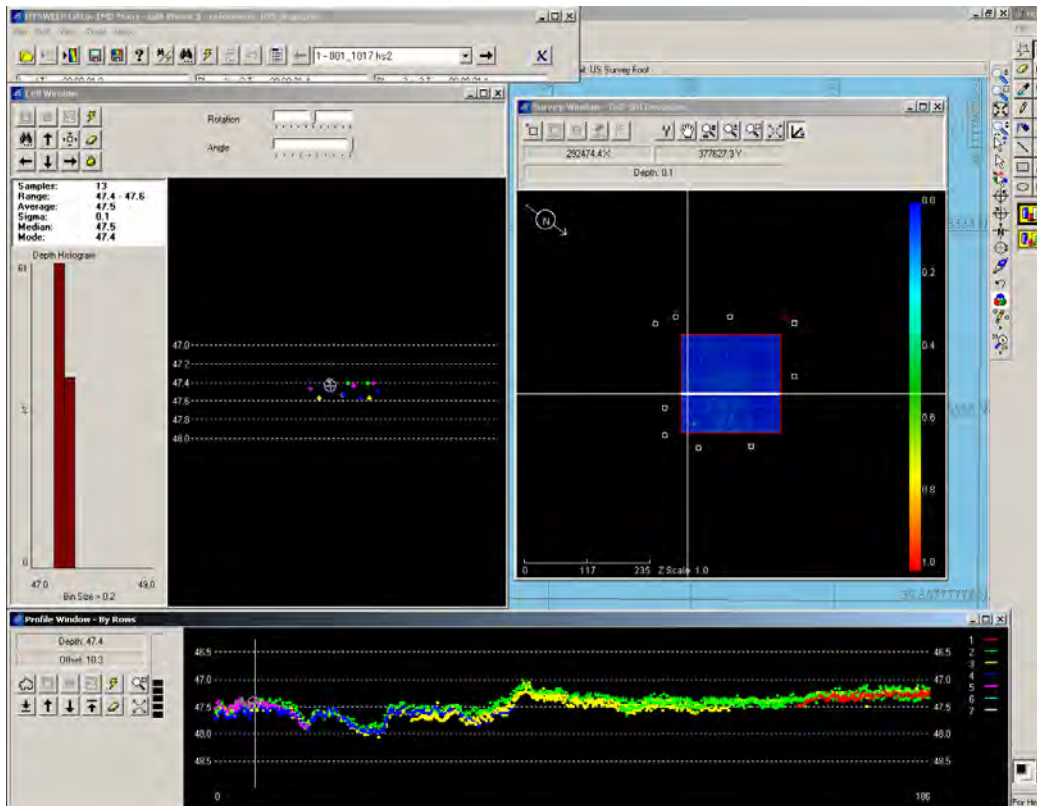

Beam Angle Test at 45 deg.

Grid Survey – Beam Angle test at 45			
Sonar / Mode	SeaBat 7125 400kHz 512 ED	Depth	50 ft
Vessel Name	SV <i>Cherneski</i>	Power / Gain / Pulse	220 / 20 / 35
Mounting Method	Hull Mount	TVG Abs / Spr	60 db / 30 db
Survey Date	2011-04-06	Roll Stabilization	On
Location	Delaware River, Fort Mifflin.	Swath Sector	90°
Area Name	Reference Survey	Cell Size	1ft
Speed / Dir	6kts	Contract Tolerance	0.82 ft (0.25m) IHO Special Order.
Comments	The test below shows that when two single crosslines (with 45 port/starboard filters being applied) are compared with the reference surface a mean depth difference of 0 ft is observed (.0 m).		

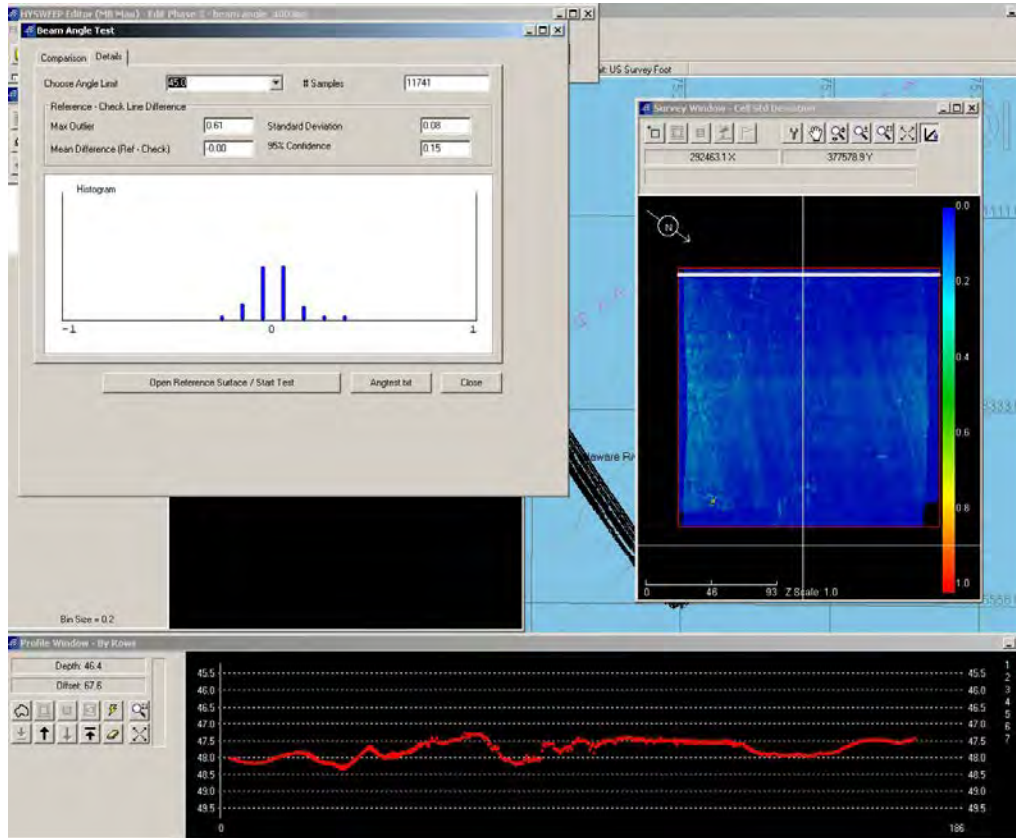

b. Beam Angle Test at Full Swath.

Grid Survey – Beam Angle test at full swath.			
Sonar / Mode	SeaBat 7125 400kHz 512 ED	Depth	50 ft
Vessel Name	SV <i>Cherneski</i>	Power / Gain / Pulse	220 / 20 / 35
Mounting Method	Hull Mount	TVG Abs / Spr	60 db / 30 db
Survey Date	2011-04-06	Roll Stabilization	On
Location	Delaware River, Fort Mifflin.	Swath Sector	128°
Area Name	Reference Survey	Cell Size	1ft
Speed / Dir	6kts	Contract Tolerance	0.82 ft (0.25m) IHO Special Order.
Comments	The test below shows that when two single crosslines (with no port/starboard filters being applied i.e. full swath) are compared with the reference surface a mean depth difference of - .05 ft is observed (.015 m).		

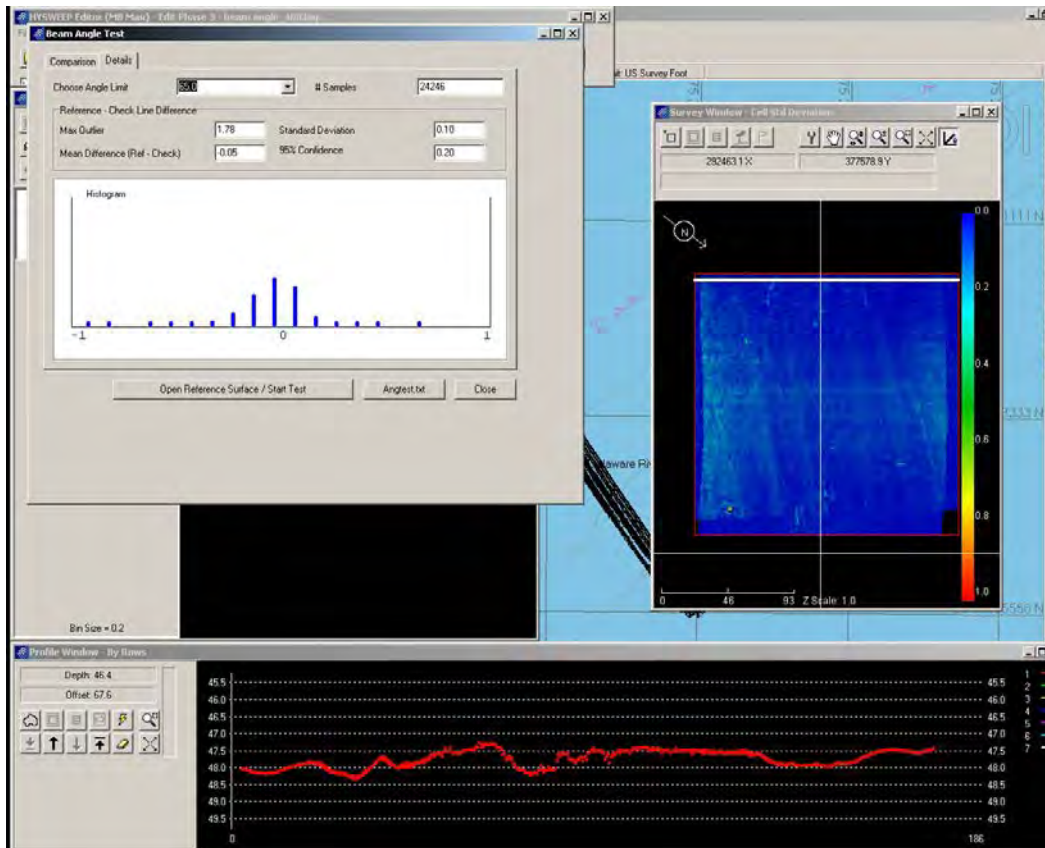

c. Beam Angle Limit Test at Full Swath.

Grid Survey – Beam Angle Limit test at full swath.			
Sonar / Mode	SeaBat 7125 400kHz 512 ED	Depth	50 ft
Vessel Name	SV <i>Cherneski</i>	Power / Gain / Pulse	220 / 20 / 35
Mounting Method	Hull Mount	TVG Abs / Spr	60 db / 30 db
Survey Date	2011-04-06	Roll Stabilization	On
Location	Delaware River, Fort Mifflin.	Swath Sector	128°
Area Name	Reference Survey	Cell Size	1ft
Speed / Dir	6kts	Contract Tolerance	0.82 ft (0.25m) IHO Special Order.
Comments	The test below shows that when two single crosslines (with no port/starboard filters being applied i.e. full swath) are compared with the reference surface a mean depth difference is observed of 0 starting at nadir to approx .05 ft (.015m) at the outermost beam. This is well within the 95% repeatability of between 0.15-0.2 ft.		

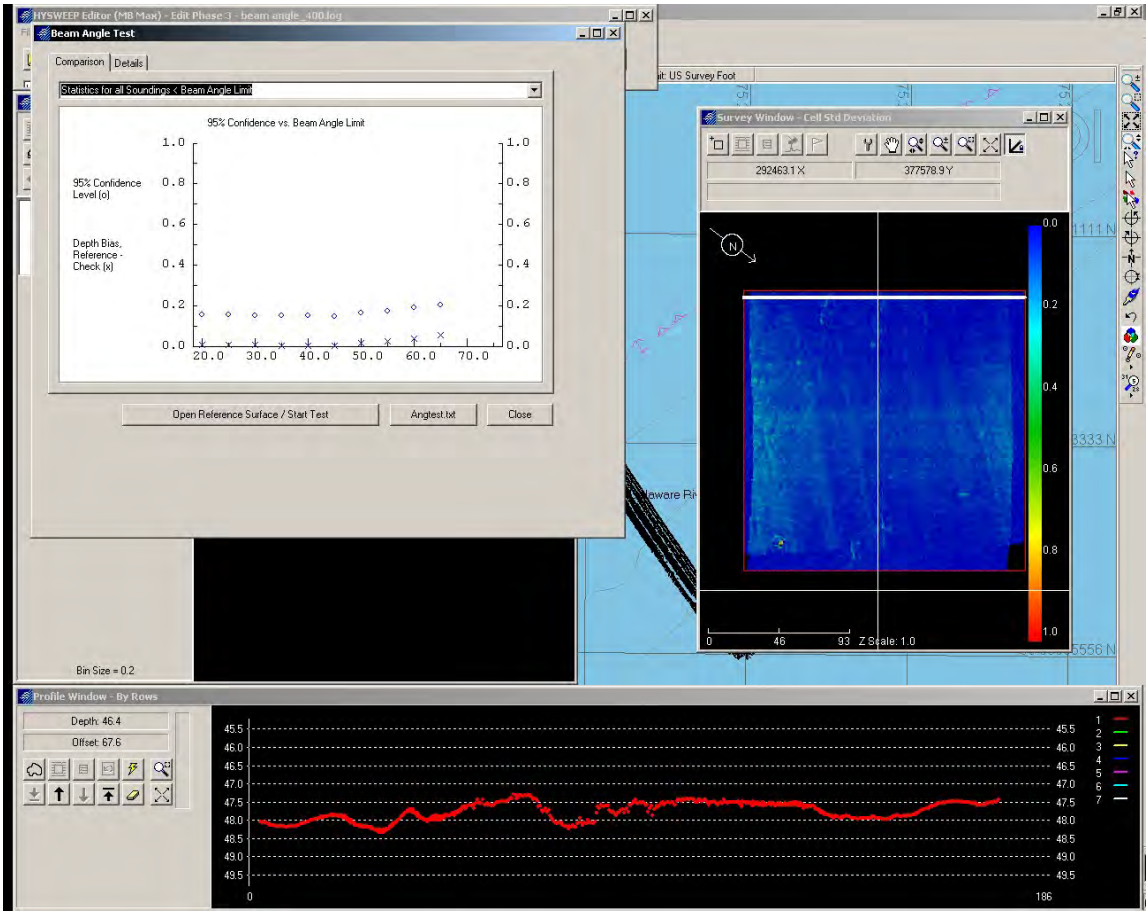

d. Single Beam Comparison.

Grid Survey – Single beam comparison.			
Sonar / Mode	SeaBat 7125 400kHz 512 ED	Depth	50 ft
Vessel Name	SV <i>Cherneski</i>	Power / Gain / Pulse	220 / 20 / 35
Mounting Method	Hull Mount	TVG Abs / Spr	60 db / 30 db
Survey Date	2011-04-06	Roll Stabilization	On
Location	Delaware River, Fort Mifflin.	Swath Sector	90°
Area Name	Reference Survey	Cell Size	1ft
Speed / Dir	6kts	Contract Tolerance	0.82 ft (0.25m) IHO Special Order.
Comments	The test below shows a comparison of cross lines run with a 200kHz single beam with the reference area (as per USACE customer requirements). This shows a mean depth difference of -.09 ft (.027 m).		

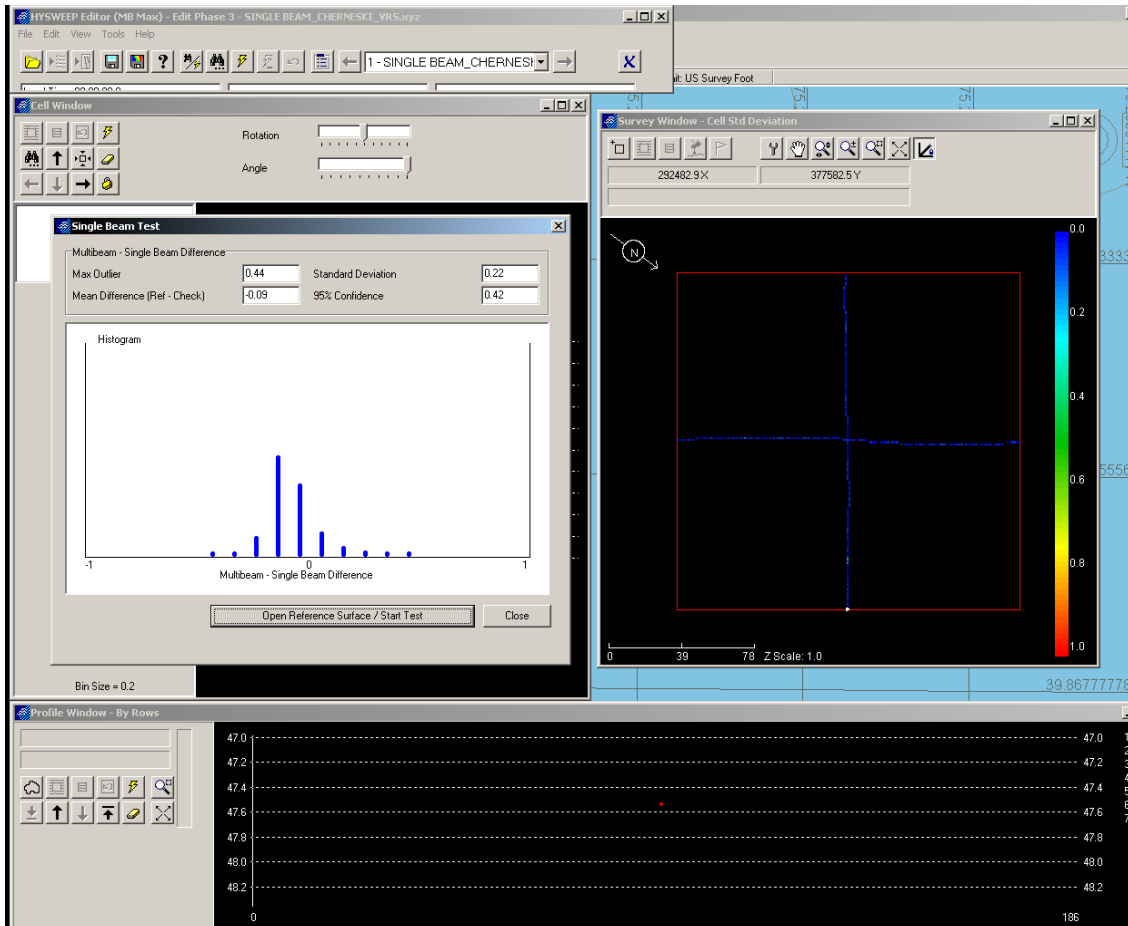

e. 200 kHz to 400 kHz Grid Comparison

Grid Survey – 200kHz to 400kHz comparison.	
Sonar / Mode	SeaBat 7125 200kHz 256 ED
Vessel Name	SV <i>Cherneski</i>
Mounting Method	Hull Mount
Survey Date	2011-04-06
Location	Delaware River, Fort Mifflin.
Area Name	Reference Survey
Speed / Dir	6kts
Depth	50 ft
Power / Gain / Pulse	220 / 20 / 35
TVG Abs / Spr	60 db / 30 db
Roll Stabilization	On
Swath Sector	90°
Cell Size	1ft
Contract Tolerance	0.82 ft (0.25m) IHO Special Order.
Comments	Although not strictly necessary, a comparison of the two grids (200 and 400 kHz) was made and a mean depth difference of -.06 ft (.018 m) was observed.

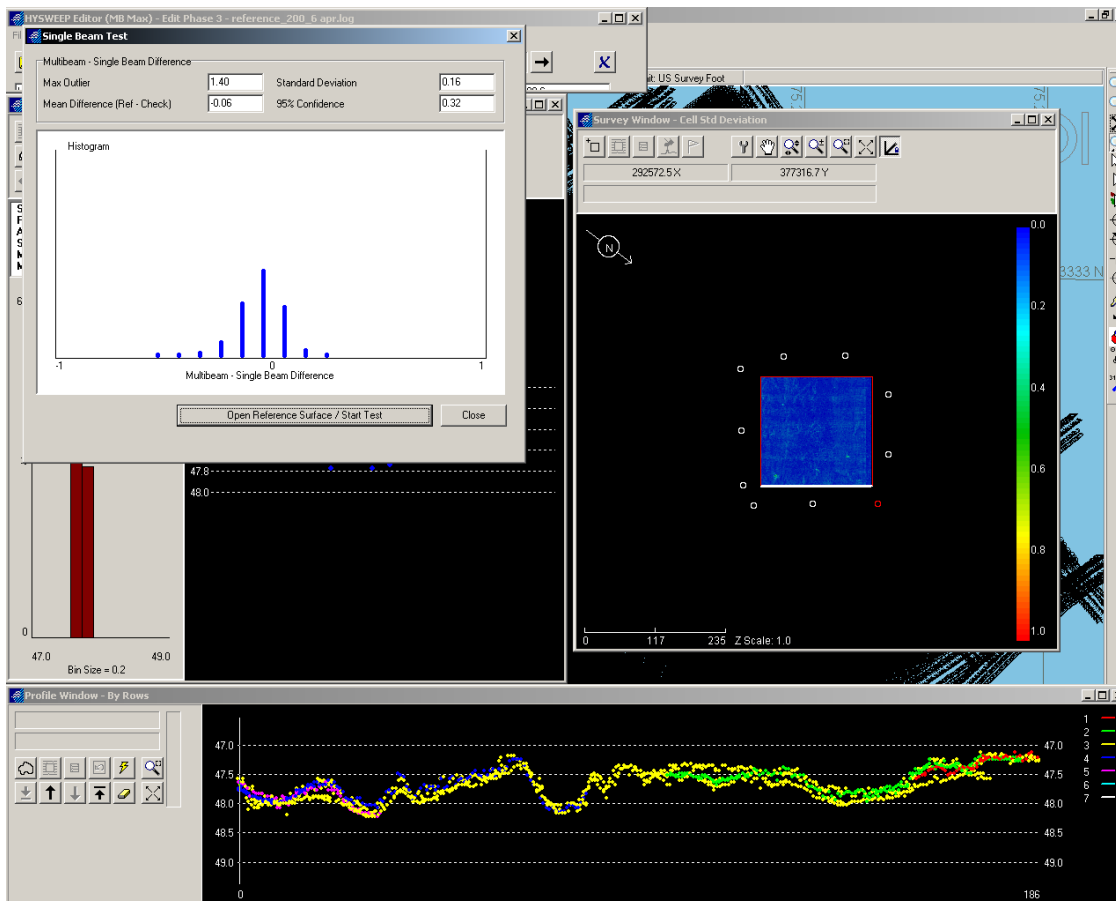

SECTION IV

Performance Tests between Independent Survey Vessels over a Dredging Acceptance Section

F-8. An ideal QA procedure compares observed X-Y-Z coordinate dataset values with coordinate values obtained from an independent source of higher accuracy for the same identical points. Obtaining an independent, higher-accuracy test area is usually difficult. A lock chamber may provide an independent reference surface; however, the acoustic return from the chamber sill may differ from the softer bottom at the project site. Thus, a preferred hydrographic QA performance test compares two nearly independent sets of elevation data collected over the same area—ideally over the actual project site. The following example compares “nearly independent” data sets collected from different multibeam survey boats, each with independent positioning, orientation, water level measurement, and depth measurement systems

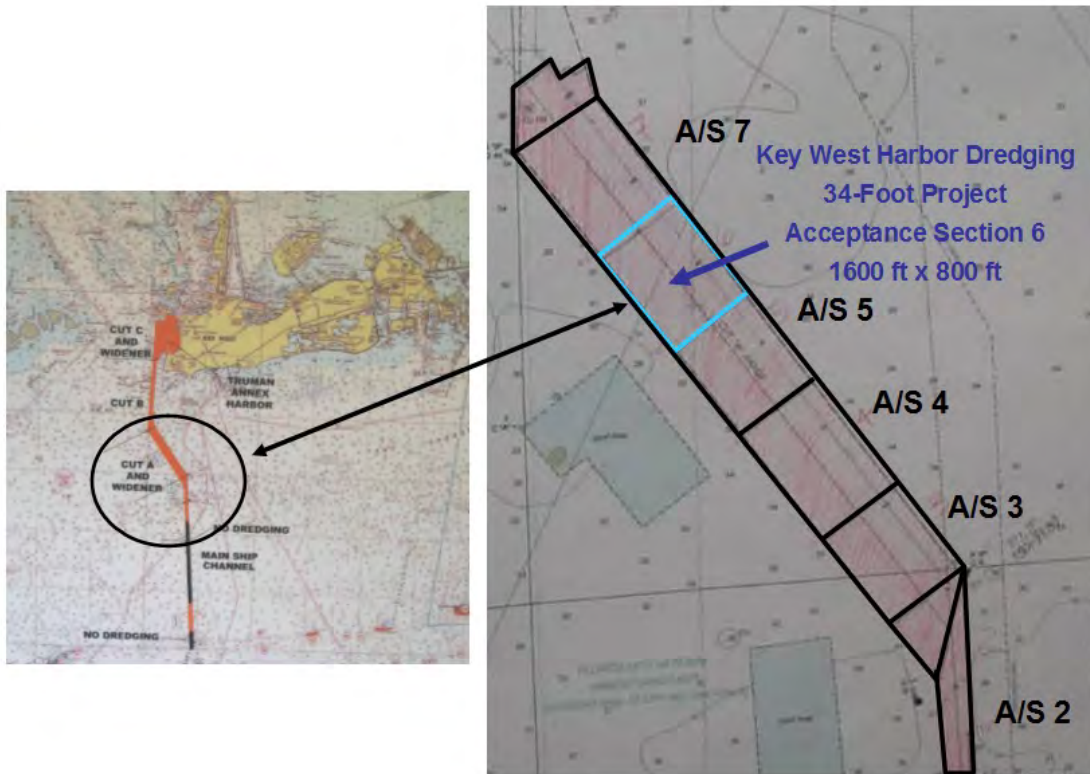

Key West, FL Main Ship Channel

The above figure shows the 2004 Jacksonville District deepening of the Main Ship Channel into Key West Harbor. Acceptance Section 6 was surveyed (after dredging clearance and payment) by two different vessels (Corps and dredge contractor). Each multibeam vessel had independent RTK base stations for reducing tide levels. All internal data collection, orientation, and processing systems were of different manufacturers. Both vessels surveyed the area at the same time. Both vessels used the same geoid model and performed RTK calibrations at a NOAA gage in Truman Basin (Key West). Due to strikes above grade, the area was resurveyed again on a later date.

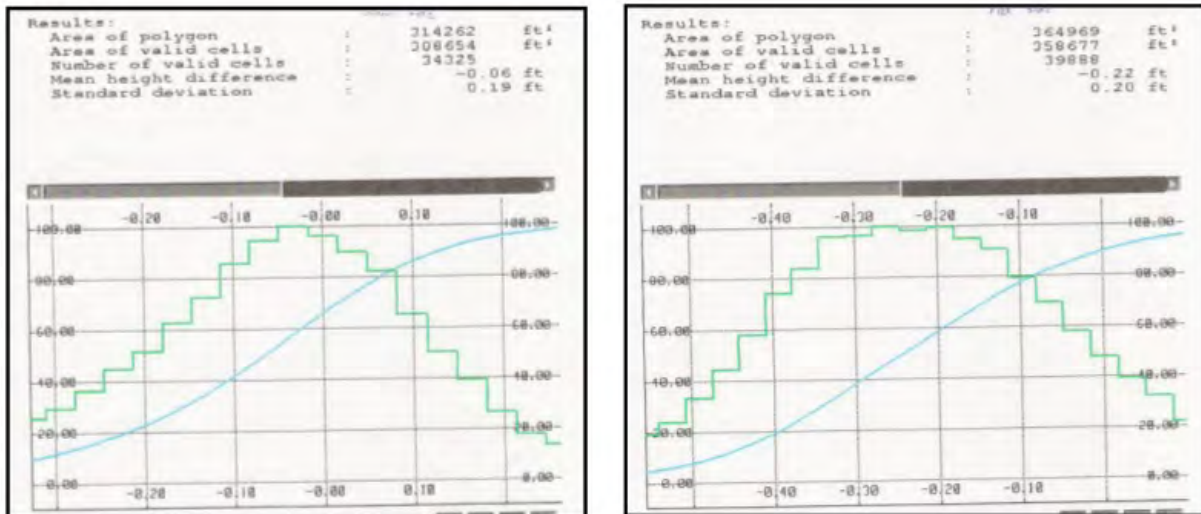

The above figure shows statistical comparisons between the two vessels. These comparisons and frequency plots were computed by the dredging contractor (Bean Stuyvesant); thus comparing their survey with the Government's survey.

The first comparison survey (on the left) indicated a "mean height difference" (i.e., "bias") between the surveys of -0.06 ft. This was based on a comparison of 34,325 overlapping points. This result is well within acceptable tolerances, and indicates there are no appreciable biases in either survey. The standard deviation (± 0.19 ft one-sigma or ± 0.4 ft at 95%) is also well within tolerances. This is expected given the relatively hard and flat channel bottom in this section.

The later resurvey (above figure on the right) did not yield an acceptable comparison test between the two vessels. A bias of -0.22 ft was observed between the 39,888 overlapping points, which is outside tolerances. (The standard deviation was the same as the first survey.)

The dilemma with the -0.22 ft bias is determining which vessel has the bias, and why. It could be a combination of non-offsetting biases on both vessels. The only practical solution in such a case was to re-calibrate all equipment and perform additional comparison surveys during subsequent clearance re-excavations.

This example illustrates that the need to test for and resolve any survey biases is critical, especially on channel clearance surveys in this example project where minimal overdepth dredging was performed, and small 0.1 ft and 0.2 ft strikes above the 34-ft grade were observed on the Government survey. As would be expected, the contractor's survey was 0.22 ft deeper than the Government's survey, eliminating most of the strikes. The impact of a 0.22 ft bias on contract payment is also significant. In this project's 800x1600 ft acceptance section, a 0.22 ft bias equated to \$584,000 (\$56/cy unit rate).

SECTION V

Summary of NAD QC and QA Criteria for Dredging Measurement and Payment Surveys.

The table below summarizes criteria for conducting multibeam surveys. This table was developed during NAD MUG meetings in the early 2000s and incorporated into EM 1110-2-1003 in 2004. The measurement, alignment, calibration, quality assurance, and data processing criteria are based on procedures followed by a variety of government and commercial sources; and especially from actual NAD experience on dredging projects since the late 1990s. The guidance in this table is applicable to measurement and payment surveys of deep-draft navigation projects. Some of it may be dated due to improved multibeam QC methods and data processing technology. The recommended calibrations and tolerances shown in this table are for general guidance only. They are not intended for Corps-wide application.

a. Frequency of tests and checks. QC and QA checks, calibrations, and other tests are recommended at beginning of all critical dredging projects, and on all surveys where high quality assurance is required (e.g., a project clearance survey in dispute). Depending on documented stability of a system, and user experience and confidence, the frequency of calibrations and performance tests may be locally modified from the indicated intervals.

b. Calibration, QC, and QA documentation. Project or contract files should contain documentary evidence that all calibration and performance tests were performed. This would include a written log (or equivalent digital record) of sensor offset and alignment measurements, patch test calibration results, sound velocity measurements, bar checks, squat calibrations, tide/stage observations, performance test results, etc. Original records of such calibrations should be retained in a permanent, bound surveyor's field book aboard the boat.

c. Other Surveys and Studies. Specific criteria for multibeam surveys outside navigation projects are not listed in the table. It is recommended that the general QC and QA procedures for dredging surveys be followed. For general underwater topographic surveys, many of these requirements can be significantly relaxed based on user experience with a particular system. This would include unlimited beam width restrictions and far less frequent calibrations. However, for detailed underwater structural investigations, more demanding criteria than that shown in the table might be warranted.

Table F-2. Quality Control and Quality Assurance Criteria for Multibeam Surveys (2004 NAD MUG)

Criteria	PROJECT CLASSIFICATION Navigation & Dredging Surveys <u>Bottom Material Classification</u>		Notes
	Hard	Soft	
<u>QUALITY ASSURANCE PERFORMANCE TEST</u>			
Perform Calibration	1/project	1/project	Test should be performed at the beginning of each new project (e.g., a pre or post dredge survey), and periodically during a longer-term project, such as a Project Condition Survey. The time interval needed between QA Performance Tests will depend on the consistency of test results.
Perform comparison with different vessel multibeam and/ or single beam	Periodically	Periodically	
Location of test	at project site	at project site	
Perform tests over same and different tidal phases	Recommended	Recommended	Tests should be conducted over same and different tidal phases to check for tidal model biases.
Maximum outliers between data set comparison points	1 ft	1 ft	
Maximum bin size for comparison data sets	1 ft sq	1 ft sq	Use averaged depth in bin for Reference Surface
Mean bias between data sets	< 0.1 ft	< 0.2 ft	The maximum mean bias computed between two data sets should not exceed the indicated tolerances
<u>POSITION QUALITY ASSURANCE CHECK</u>			
	1/day	1/project	Check different DGPS beacons, known point, etc.

EM 1110-2-1003
30 Nov 13

Table F-2 (cont) Quality Control and Quality Assurance Criteria for Multibeam Surveys (2004 NAD MUG)

Criteria	PROJECT CLASSIFICATION Navigation & Dredging Surveys <u>Bottom Material Classification</u>		Notes
	Hard	Soft	
<u>SOUND VELOCITY CALIBRATION</u>			
Perform velocity probe calibration	> 2/day	2/day	Velocity casts should be taken at the indicated intervals. They should be taken directly in the work area and at a density such that the water column is adequately modeled. More frequent calibrations may be needed in conditions where temperature or salinity are variable, or where Performance Test data indicates large variances are present.
Location of calibration	In project site	In project site	
Record velocity to nearest	1 fps	1 fps	
Record velocities in water column every	5 ft	5 ft	
Perform internal (distilled water) probe calibration	Weekly	Monthly	
<u>BAR or BALL CHECK ON CENTER (NADIR) BEAM</u>	Quarterly	Quarterly	A QC Bar Check should be made as near to the nadir beam as possible. This periodic check is used to verify/calibrate any index or draft error in the system.
<u>SQUAT TEST CALIBRATION PERFORMED</u>	Annually	Annually	
<u>PLATE CHECK ON OUTER BEAMS</u>	Daily	Daily	Perform before each survey as QA "blunder" check if possible.
<u>RECORD SHORT TERM VESSEL DRAFT VARIATIONS</u>	2/day	2/day	

Table F-2 (cont) Quality Control and Quality Assurance Criteria for Multibeam Surveys (2004 NAD MUG)

Criteria	PROJECT CLASSIFICATION		Notes
	Navigation & Dredging Surveys	Bottom Material Classification	
	Hard	Soft	
<u>OBJECT DETECTION CONFIDENCE CHECK</u> (for specialized search surveys only)	Daily	Daily	Similar to side scan confidence check Verify hits on multiple passes over object
<u>MAXIMUM BEAM ANGLE</u>	90-deg	90-deg Meas & Pay Surveys 120-deg Proj Cond Surveys	Beam/swath width should generally not exceed the indicated values, unless independent QA performance test results indicate depth accuracies can be achieved with wider arrays. The beam angle may be further reduced for critical object detection--due to footprint expansion and poorer return from outer beams--or should QA performance test results indicate poor correlation in the outermost portion of the array.
<u>BEAM OVERLAP</u>	50%	10%	In navigation projects, a 50% side overlap (i.e., 200% bottom coverage) is strongly recommended when sweeping for rock shards or other hazardous objects remaining above project grade. Two or more overlapping passes on different aspects of the beam are recommended in shoal areas--to confirm hits above grade.
<u>MAXIMUM SURVEY SPEED</u>	2-5 kts	6-12 kts	Recommended speeds are prescribed to

EM 1110-2-1003
30 Nov 13

ensure data integrity and minimize latency errors. Further limitations may be required for multibeam or side-scan systems to ensure 100% or greater forward (along-track) coverage or object detection.

Table F-2 (cont) Quality Control and Quality Assurance Criteria for Multibeam Surveys (2004 NAD MUG)

Criteria	PROJECT CLASSIFICATION		Notes	
	Navigation & Dredging Surveys	Bottom Material Classification		
	Hard	Soft		
<u>INSTRUMENT ALIGNMENT/OFFSET MEASUREMENTS</u>				
Measure Antenna-Transducer-Inertial system relative coordinates to nearest	0.05 ft	0.05 ft	Alignment measurements are performed on installation or change of equipment.	
<u>PATCH TEST BIAS CALIBRATIONS</u>				
Perform test	as needed	as needed	The time interval required between Patch tests is dependent on Quality Assurance Performance Test results -- usually when mandatory QA Performance Tests indicate data is not meeting standards. No specific interval is recommended.	
Patch Test Bias Repeatability (individual test)				
	Roll	0.1 deg	0.1 deg	Corrections should be averaged over a long series of Patch Tests, rather than using the results from a single test. Enter data to one decimal point better than repeatability.
	Pitch	1 deg	1 deg	
	Yaw	1 deg	1 deg	
	Latency	0.1 sec	0.1 sec	

Resolution in system	0.1 deg/sec	0.1 deg/sec	Significant figure of correction
<u>HEAVE CORRECTIONS (MRU)</u>			
Measure heave to accuracy of	5%	5%	or 5% of heave amplitude
MRU/RTK update rate at least	20 Hz	20 Hz	

Table F-2 (cont) Quality Control and Quality Assurance Criteria for Multibeam Surveys (2004 NAD MUG)

Criteria	PROJECT CLASSIFICATION		Notes
	Navigation & Dredging Surveys	Bottom Material Classification	
	Hard	Soft	
<u>MISCELLANEOUS CRITERIA</u>			
<u>MINIMUM PROJECT DEPTH (Dredging Surveys)</u>	> 10 ft	> 10 ft	Limiting depth is system dependent. Multibeam systems are recommended for dredge measurement, payment, and acceptance purposes in project depths greater than those shown.
<u>ACOUSTIC FREQUENCY</u>	Project Option	[< 20 KHz to > 500 KHz]	A nominal 200 kHz frequency is recommended for most USACE navigation projects; however, different frequency systems may optionally be used if needed for better beam definition on objects (e.g., 450 KHz) or to penetrate suspended sediments in a particular project area (e.g., 24 KHz). The same frequency should be consistently used for a specific project and specified in dredging contracts.

Table F-2 (cont) Quality Control and Quality Assurance Criteria for Multibeam Surveys (2004 NAD MUG)

Criteria	PROJECT CLASSIFICATION		Notes
	Navigation & Dredging Surveys <u>Bottom Material Classification</u> Hard	Soft	
<u>RECOMMENDED DEPTH SELECTION AND DATA PROCESSING/THINNING BIN MATRIX LIMITS</u>			
<u>Dredging Measurement & Payment Surveys and Project Condition Surveys (including those used for contract Plans & Specifications)</u>			
Bin/Cell size--Recommended maximum	3 ft sq	5 ft sq	The X-Y coordinate origin of the matrix should be specified.
Depth Selection--Method used to select representative depth from multiple depths in a cell for use in volume computations	Average of all depths in 3x3 cell	Average of all depths in 5x5 cell	Average depth is truncated to nearest 0.1 ft and located at the cell centroid X-Y coordinate. (Median depth in cell may alternately be used)
Volume computation method	Full DTM/TIN binned matrix	Full DTM/TIN binned matrix AEA optional	Volumes should be computed using the selected representative depths from the entire 3 x 3 or 5x 5 ft sq dataset matrix. AEA cross section spacing should be appropriate to channel topography.
Depth Plot (Plan)--Method used to select depths from cell matrix for a generalized hard copy display of individual depths/elevations	Randomly selected 3x3 ft cells containing representative shot depth	Randomly selected 5x5 ft cells containing representative shot depth	Density of plotted data dependent on output drawing scale. Plotted depths are generalized representations of the full multibeam dataset and should not be used for quantity computations. Shot depth may be shifted to center of 3x3 or 5x5 ft cell.

EM 1110-2-1003
30 Nov 13

Contour or Color-Coded Plot-- Method used to select depths from a cell matrix for generating contours or DTM color-coded plots

Use all 3x3 cells containing representative shot depth

Use all 5x5 cells containing representative shot depth

Full edited database used.

Table F-2 (cont) Quality Control and Quality Assurance Criteria for Multibeam Surveys (2004 NAD MUG)

Criteria	PROJECT CLASSIFICATION		Notes
	Navigation & Dredging Surveys <u>Bottom Material Classification</u> Hard	Soft	
<u>RECOMMENDED DEPTH SELECTION AND DATA PROCESSING/THINNING BIN MATRIX LIMITS</u> (Continued)			
Dredge Clearance & Acceptance Surveys (Shoal/Strike detection) and Minimum Channel Clearance Condition Reports			
Depth Selection--Method used to select representative "shoalest" depth from multiple depths in a cell	Shoalest of 3 confirmed depth hits above project grade in 3x3 cell	Shoalest of 3 confirmed depth hits above project grade in 5x5 cell	Individual cells must be assessed to determine multiple hits above grade.
Number of confirmed "hits" above grade required per cell	3 hits	3 hits	Based on a single pass or multiple passes. Hits on multiple passes provide better confidence.
Depth Plot (Plan)--Method used to select plotted depths from cell matrix for a generalized hard copy display of the shoalest individual depths above grade	Selected cells containing representative shoalest confirmed depth	Selected cells containing representative shoalest confirmed depth	Density of selected cells that can be plotted dependent on output drawing scale.

Contour or Color-Coded Plot-- Method used to select depths from cell matrix for generating contours or DTM color plots

Use all 3x3 cells containing representative shoalest depth

Use all 5x5 cells containing representative shoalest depth

Full edited database matrix used.

Tabular Report of Channel Conditions
(ENG Form 4020/4021)

Method used to select minimum controlling depth for channel reach

Least recorded depth in 3x3 ft cells containing representative shoalest confirmed depth

Least recorded depth in 5x5 ft cells containing representative shoalest confirmed depth

Select least controlling depth from all the cells contained over a given channel reach. Selected controlling depth should be shown on plan of condition survey if submitted.

Record minimum controlling depth to nearest

1 ft

1 ft

EM 1110-2-1003
30 Nov 13

THIS PAGE INTENTIONALLY LEFT BLANK

APPENDIX G

Terrestrial (Non-GPS) Positioning Methods

G-1. General Scope and Applications. This appendix covers general procedural guidance and quality control criteria for visual, mechanical, electronic, and microwave positioning methods used to control surveys of river and harbor projects. Terrestrial positioning methods include traditional land-based techniques such as sextant resection, triangulation, tag lines, microwave electronic distance measurement (EDM) systems, and electronic total stations. Since the early 1990's most of these terrestrial positioning methods have been largely replaced by satellite-based positioning methods, namely code phase differential GPS (DGPS) and carrier phase RTK.

a. The positioning methods in this appendix were developed in the 1980s prior to the use of GPS. It was included in the first version of EM 1110-2-1003 in 1991. It is largely unchanged since that original version.

b. Some of these terrestrial methods covered in this appendix are obsolete (e.g., microwave positioning, triangulation, sextant positioning). They are retained in this Appendix for archival purposes. Other methods are still occasionally employed by USACE districts and their contractors, such as Total Station and tag line positioning. (Updated Total Station survey methods are included in EM 1110-1-1005, Control and Topographic Surveying.)

c. There may be isolated project areas where satellite GPS methods may be inaccessible or impractical, and one of the traditional terrestrial survey methods covered in this appendix may be needed to provide survey control. Examples of such cases may include: (1) small dredging or marine construction projects where only a limited amount of depth coverage is required, (2) areas under bridges, in deep-draft harbor berths, or near dams where GPS satellite view is blocked, (3) intermittent, low-budget projects where traditional positioning methods may prove more economical than equipping a fully automated GPS-based hydrographic survey system, or (4) rough reconnaissance surveys where meeting a specific positional accuracy standard is not required. Procedural methods and quality control (QC) criteria for some of these older survey techniques are retained in this manual primarily for reference purposes.

d. The following topics are covered in this appendix:

- Section I: Sextant Resection Positioning
- Section II: Triangulation/Intersection Positioning
- Section III: Visual Positioning Methods
- Section IV: Tag Line Positioning Methods
- Section V: Total Station (Range-Azimuth) Positioning Methods
- Section VI: Terrestrial Electronic Positioning Systems

G-2. Positional Accuracy. All the positioning methods described in this appendix will generally meet USACE positional accuracy requirements, provided that distances from the shore-based

reference point and the vessel are kept within tolerable limits. The "tolerable limit" will vary with the type of positioning method, procedures employed, and accuracy of the instrumentation used. In general, the positional accuracy of all systems will degrade as a function of distance from the baseline reference points--some faster than others. For example, a poorly conducted tag line survey may exceed accuracy standards 300 feet from the baseline whereas an electronic total station could be extended 1000 ft or 2000 ft from the reference point. Sextant, triangulation, and range-range EDM are extremely geometry dependent; thus the accuracy of such methods will vary widely over a project area. Terrestrial-based positioning methods should only be employed where GPS positioning is not available. Users must also fully assess and evaluate the resultant accuracy of any positioning method, including GPS. Some visual or mechanical positioning methods can, under some limited conditions, exceed DGPS or RTK accuracies.

SECTION I

Sextant Resection Positioning

G-3. General Applications. Sextant positioning involves the simultaneous observation of two horizontal angles between three known objects from which the position of an offshore platform is resected--see Figure G-1. Although sextant resection positioning was once one of the most widely used methods of positioning hydrographic survey vessels, channel sweep rafts, and dredges, it is now rarely, if ever, used. Sextant positioning was also widely used to calibrate medium frequency hyperbolic, range-range, and microwave positioning systems. Until the mid 1990s, sextant positioning was the primary method used by the US Coast Guard to locate and place buoys. Sextant positioning is totally performed aboard the survey vessel. It is not dependent on electronics, communications, or shore-based support. Under restricted conditions (i.e., close in on targets and near static position fixes), it can be relatively accurate when properly executed. In general, however, sextant positioning under dynamic vessel conditions is no longer considered accurate for most navigation or dredging applications. Currently, inexpensive hand-held GPS (autonomous) receivers will typically provide accuracies that far exceed sextant positioning accuracies.

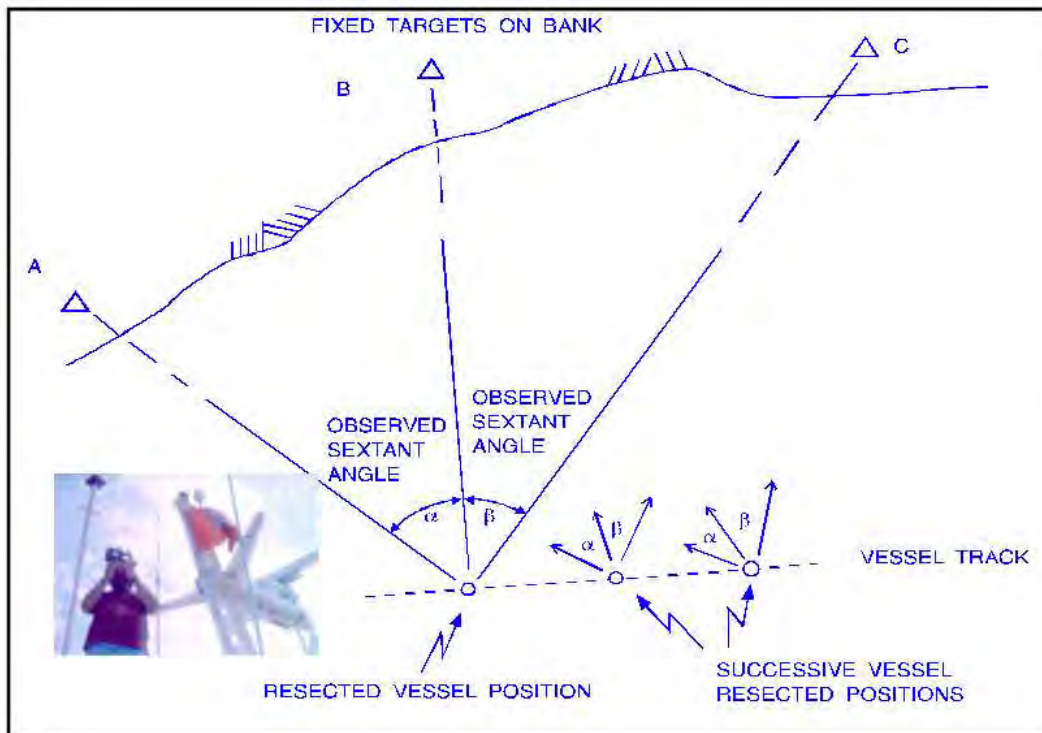

Figure G-1. Sextant resectioning.

G-4. Sextant Resectioning Procedures. Two sextant observers aboard the vessel are required. Sextant "fix" angles are usually taken at some even time interval or as called for by the depth observer (lead line or echo sounder). These angles are called or radioed to the recorder/plotter, along with depth information from that observer. Observed sextant angles are recorded with their times and, if applicable, depth data. These data can be recorded on a worksheet form or in a standard field survey book, or they can be directly input into a data logging device. The vessel's position is determined at the time of the fix by manual plotting with a three-arm protractor. Preconstructed constant sextant angle curves can also be drawn on a plotting sheet for on-line manual plotting. Alternatively, the two observed angles can be input into a computer containing standard survey resection software. Formulas for performing such computations are found in any standard surveying or geodesy textbook. The density of position fix updates varies with the timing and speed of the sextant observers and plotter/computer input. Overall, the process is extremely labor-intensive, requiring a boat operator, two sextant observers, a depth recorder operator, and a data logger/plotter. In extreme cases, these functions can be doubled or even tripled up (i.e., one of the sextant observers could also perform the recording and plotting function).

a. Hopper dredge positioning. A single sextant angle may be used in conjunction with a fixed range line of position, as shown in Figure G-2. In years past this was a common technique for

locating hopper dredges. Preplotted sheets showing the intersecting sextant angles and ranges were drawn up for each channel. A single sextant angle would quickly locate the dredge running along a constant channel range. Figure G-3 depicts sextant angle curves used for positioning sweep rafts in Detroit District prior to the 1980s.

b. Redundant sextant resectioning. On stable offshore vessels and other platforms, multiple sextant angles can be observed to several targets. The resultant fix can be adjusted by onboard software using least squares adjustment techniques. This adjustment will provide an assessment of the positional accuracy. The results of a multiple resection can be quite accurate, and can be less than +1 m in some isolated cases. The US Coast Guard used this technique on buoy tenders.

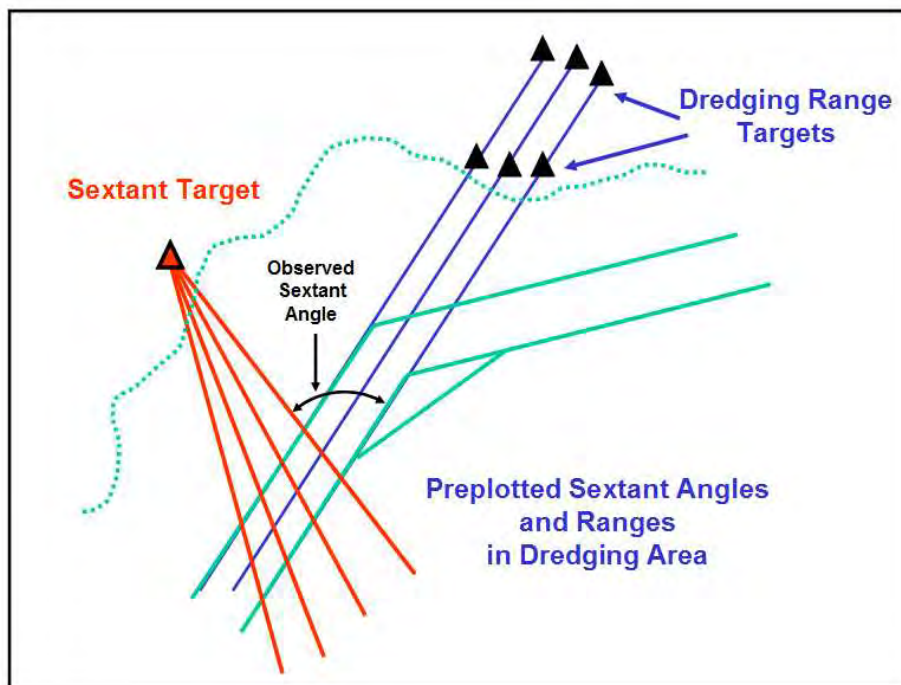

Figure G-2. Hopper dredge control using combined visual ranges and sextant angles.

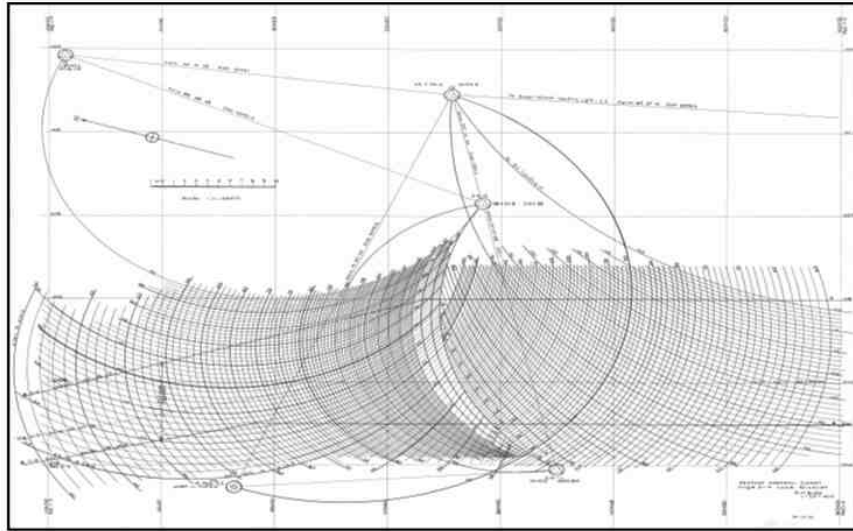

Figure G-3. Pre-plotted sextant curves for bar sweep on the St. Marys River, MI. (Detroit District)

G-5. Accuracy and Quality Control of Sextant Resection Positioning. The two observed sextant angles form the loci of circles, the intersection of which is the vessel's position. Each angle forms a circle defined by three points: the two shore control points/targets and the vessel. The geometry of these two intersecting circles is a primary factor in determining the strength of a sextant resection. As the two intersecting circles converge on each other, the resultant position weakens drastically. This is often termed the "swinger" since a three-arm protractor will swing along this arc to any position. As a result, the accuracy of a sextant position varies significantly with the geometrical location relative to the targets. In the best conditions, dynamic positional accuracies rarely exceeded 5 m (95% RMS). Average accuracies were generally in the 10 to 20 meter range.

a. Determining the accuracy of a resected position. Historically, various numerical formulas were developed to depict the relative accuracy of a resected position. Constant error contours could also be drawn for any given target configuration. The simplest method for estimating resection accuracy at any point is to move each angle by its estimated accuracy and assess the resultant change in position. This is readily done when automated resection computing software is available, or by noting the position shift in a three-arm protractor. Positional accuracy needs to be assessed at various points in the work area.

b. Quality control factors. In performing sextant resection positioning the following QC factors must be considered. All impact the overall accuracy of a resected position.

(1) Precision of sextant angles. This is a function of the instrument's resolution, sharpness of the shore-based targets, relative rate of angular change, and, most importantly, the skills of the observers. Estimating the standard error of a sextant angle observed on a moving vessel is difficult--

a range of ± 1 to ± 5 minutes of arc is typical. Sextant angles are usually recorded to the nearest minute of arc and, in some cases, to the nearest 0.1 minute of arc.

(2) Observer synchronization. Both angles must be observed simultaneously and from the same point. This is usually not feasible in practice, and observer eccentricities are accepted errors.

(3) Plotting errors. Plotting sextant fixes with a three-arm protractor aboard a moving vessel is not an exact process, and significant inaccuracies can result.

(4) Velocity and motion of the vessel. Vessel motion affects the ability of the observers to maintain angles on both targets. Slow vessel velocities are essential in performing accurate sextant surveys.

(5) Observer fatigue. Continuous sextant surveying is extremely fatiguing for the observers and plotter. Data quality usually degrades during the course of a survey due to fatigue.

(6) Targets. Sextant angle targets may include water tanks, lights, daymarks, beacons, etc. When natural targets with coordinated points are not available, temporary targets must be constructed and surveyed. The type of target (and its distance away when fog or haze is present) affects the sextant pointing accuracy.

c. Sextant calibration. Due to design and handling, internal sextant instrument calibration is not particularly stable. Observers must continuously check the calibration of their sextants. This is usually done periodically during the survey--typically at the end of each survey line.

d. Quality assurance. Few opportunities existed to perform QA checks on sextant positioning. When more than three targets were visible, different resection positions could be compared at an anchored position.

SECTION II

Triangulation/Intersection Positioning

G-6. General Applications. An offshore vessel or platform can be positioned (triangulated) by transit or theodolite angles observed from base line points on shore. This method was also once commonly used to calibrate microwave positioning systems when fixed points were inaccessible to the vessel (e.g., dredges, drill barges). Intersection techniques are no longer employed in dynamic hydrographic surveying practice; however, the technique may have application in areas where electronic positioning systems cannot be deployed or where increased positional accuracy is required. As with sextant surveying methods, angular intersection positioning techniques are labor-intensive. As indicated in Figure G-4, two (or more) shore-based transit or theodolite observers are required, along with either visual or radio communication equipment with which to transmit the

observed angles (or direction azimuths) to the offshore vessel for on-line recording, plotting, and/or calibration analysis. Due to the higher precision and stability of the instruments, the resultant positional accuracy can be quite good, provided observing procedures are properly executed. Theodolite angular observations to align static platforms are extremely accurate, and triangulation techniques are often used to supplement electronic distance measurement (EDM) or RTK positioning of fixed offshore structures (piers, bridges, rigs, etc.)--both during construction and subsequent deformation monitoring.

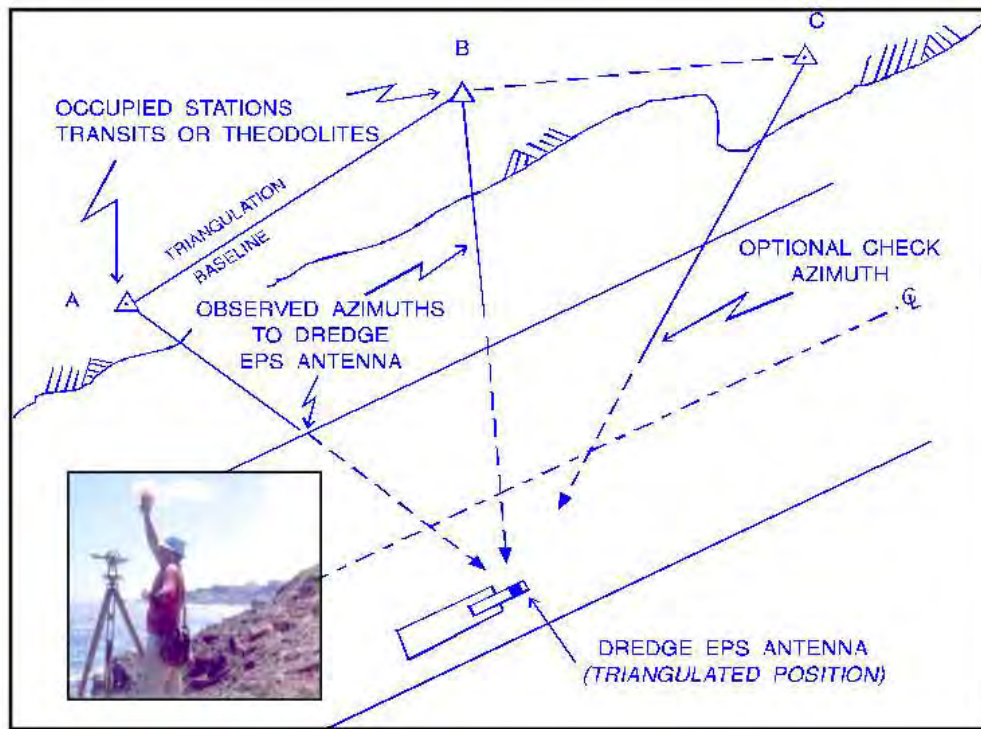

Figure G-4. Vessel location using triangulation/intersection positioning methods.

G-7. Intersection Positioning Procedures. A wide variety of angle or azimuth direction measuring instruments may be used. These include standard surveying transits, geodetic theodolites, and total stations. Instruments have been designed with hand cranks to facilitate continuous tracking of a moving vessel. The shore-based direction measuring instruments are set over known control monuments and aligned/referenced to one another or other positioned targets or landmarks. Two backsight check points are recommended, and frequent rechecks of the backsight orientations should be made during the course of the survey (normally every half-hour). Backsight orientations may be set to zero (resultant direction observations to the boat are then angles) or aligned to the grid azimuth between the occupied point and reference backsight (resultant directions to the boat are direct grid azimuths). The selected orientation depends on the onboard position computation/plotting method employed. Simultaneously observed positional "fixes" are usually called for from the boat by radio (or by visual flags where radio communication is unavailable). Fixes may be at equal time intervals or as called for on a random or as-needed basis. Advance warning is made of upcoming fix events so that observers can initiate precise tracking of the boat. A defined point aboard the vessel is tracked. This well-marked point should be centered over the echo sounder transducer or may be the positioning system antenna in the case of calibration work. In some instances, a preset alignment of an offshore platform is required. In this case, the precomputed alignment is set into each of the instruments and the platform is "walked" into position by the observers.

G-8. Data Recording and Plotting. Angles/direction azimuths are observed to units commensurate with the instruments and relative distance and velocity of the offshore vessel. Normally the nearest minute (or 0.01 deg) is adequate for dynamic hydrographic applications. Static observations will use repeated directions to increase accuracy to the ± 1 second of arc level if needed. Angular data are relayed to and recorded aboard the boat and, in cases in which communications are erratic, at the instrument point also. Data may be recorded on worksheet forms or standard field survey books or input into a data logging device. Intersection data may be plotted aboard a dredge or survey vessel using standard drafting machines or preplotted azimuth array sheets. Neither of these methods is considered highly accurate, but each is adequate for visual navigation purposes

G-9. Accuracy of Triangulation/Intersection Positioning. As in conventional land surveying triangulation work, the accuracy of a point intersected by two azimuth directions depends on the precision of the instruments (their tracking accuracy) and the geometrical strength of the intersection. The positional accuracy, therefore, varies throughout the project area. An overall error analysis is complex since the angular standard errors for each instrument vary as a function of distance between the instrument and the vessel. Thus, determining the dimensions of the resultant error ellipse is more difficult.

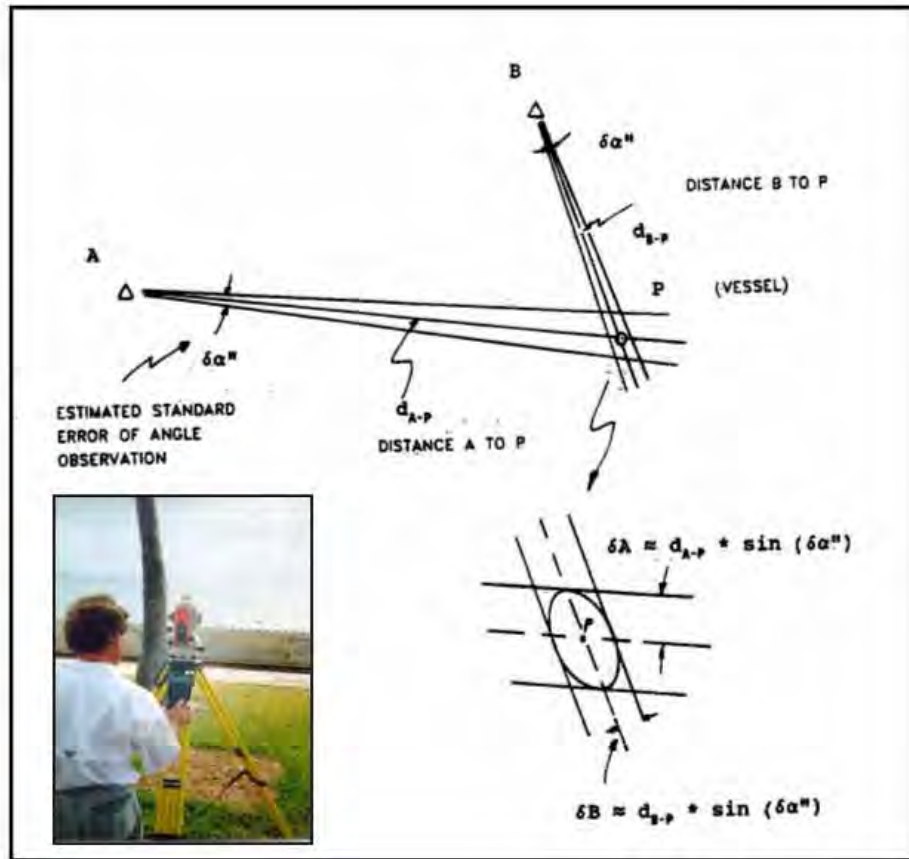

Figure G-5. Estimating accuracy of intersected angles.

a. A practical (but only approximate) estimate of the accuracy of an intersected position may be made by averaging the standard errors of each azimuth displacement at the offshore location, using the computed distances from each observing point. Given the theodolite/transit observing points A and B, and distances d_{A-P} and d_{B-P} to the offshore platform (Figure G-5):

$$\delta_A = d_{A-P} \cdot \sin(\delta\alpha'')$$

$$\delta_B = d_{B-P} \cdot \sin(\delta\alpha'') \quad (\text{Eq G-1})$$

$$\text{then, } \sigma_{\text{Avg}} = (\delta_A + \delta_B) / 2$$

where

σ_{Avg} = estimated standard error of an azimuth displacement at the offshore point

$\delta\alpha''$ = estimated angular tracking accuracy of the particular instrument used

(assumed the same for both instruments)

b. The RMS error (at either 1- σ or 95%) can be estimated using Equation G-2:

$$\text{RMS (1-}\sigma\text{)} = 1.414 \cdot \sigma_{\text{AVG}} \cdot \text{cosec } A \quad (\text{Eq G-2})$$

or at 95% confidence level;

$$\text{RMS 95\%} = 2.447 \cdot \sigma_{\text{AVG}} \cdot \text{cosec } A$$

where A is the angle of intersection between the two transit/theodolite azimuths at the offshore point.

c. The above computation may also be performed graphically. The left page in Figure G-6 depicts a sample field computation of the accuracy of a static intersected point (i.e., spudded dredge) using the above approximate formulas. The right page shows an alternate method of computing the RMS accuracy when the distances are simply averaged.

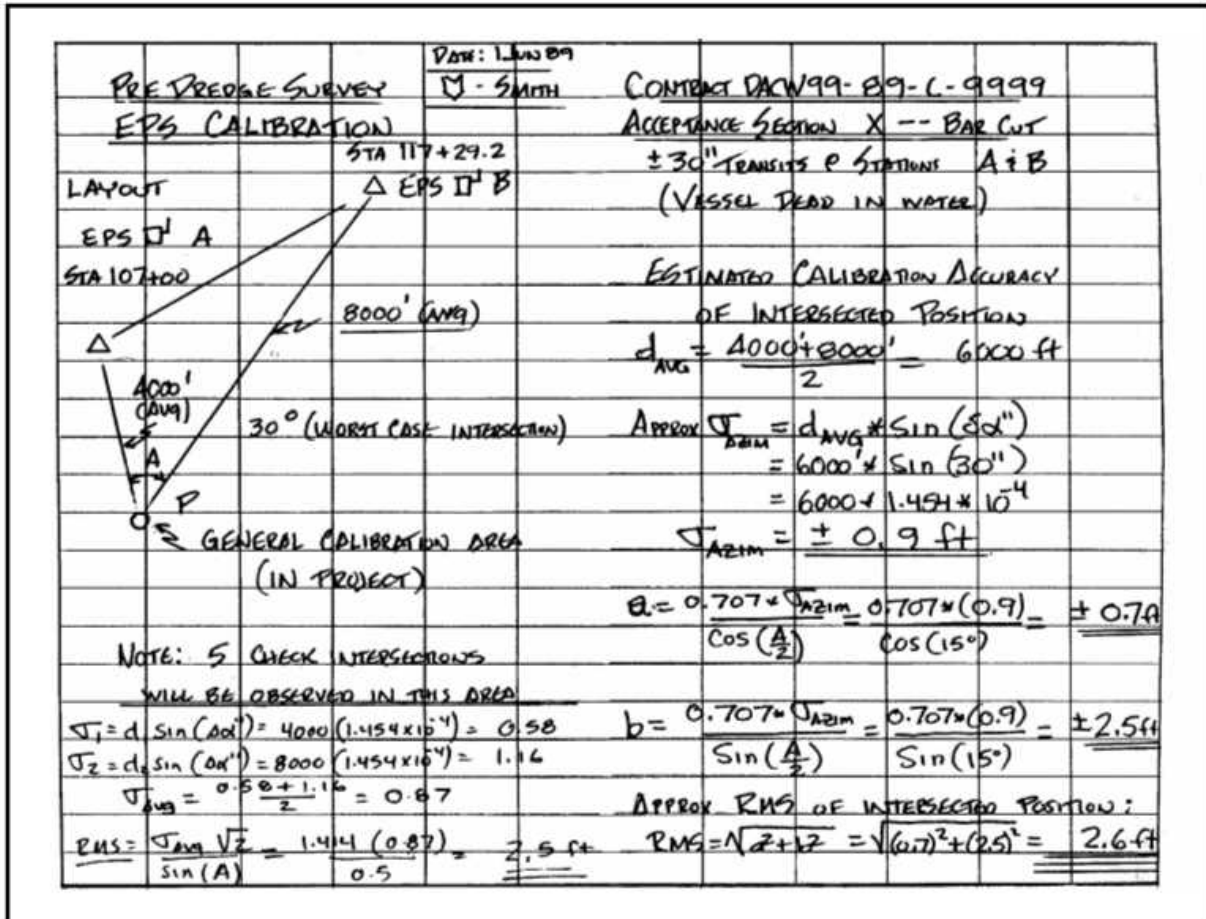

Figure G-6. Field computation of intersected position accuracy.

d. Multiple azimuth intersection techniques. To increase the accuracy of a triangulated point, additional shore stations are occupied in such a manner that each vessel position has three or more azimuth observations. This procedure provides redundancy and allows for an on-line assessment of the accuracy of the resultant position. Normally, a least-squares adjustment technique is performed on computers aboard the vessel. In aligning offshore structures during construction, or monitoring subsequent deformations, redundant theodolite azimuths are normally required. Theodolite (or total station) directions are repeatedly observed to increase accuracy. These azimuth alignments are combined with concurrent EDM or static GPS baseline distance observations in a properly weighted least-squares adjustment.

G-10. Quality Control and Quality Assurance. Periodic backsight checks should be made during the course of the survey. Like sextant survey methods, observer and plotter fatigue can impact quality. A third instrument provides the only semblance of an independent QA check on intersected point; however, this was rarely practical in practice.

SECTION III

Visual Positioning Methods

G-11. General Applications. Visual location relative to known shore features or flags was once a common hopper dredge positioning method. Few applications remain today, other than for construction--e.g., horizontal and vertical alignment of construction equipment, rigs, barges, etc. Dynamic hydrographic survey positioning by intersecting visible ranges and other identifiable objects is now rarely performed, given the wide availability of DGPS, RTK, or RTN control. Relative visual positioning is generally suitable only for non-navigation reconnaissance work where identifiable features on the furnished drawing, navigation chart, or map will be assumed to be accurate for this type of survey. These include navigational aids, beacons, day markers, bridges and other structures or map features. For some dredging and other investigative work, additional range poles, flags, and/or lasers are set ashore, as shown in Figure G-7. Fixes are typically taken when the boat is abeam or lateral of an identifiable object and a constant speed is maintained to the next identifiable object or range intersection. Intermediate soundings are interpolated between the two fixes. The plotted features are presumed to be error-free, and a constant vessel speed is assumed to have occurred between the control features. Ranges established by sighting across such features or additional shore points may be intersected for position determination. Accuracies of such surveys are considered marginal, at best. All drawings depicting these surveys should caution users concerning the approximate nature of the data and warn against their use in design or construction.

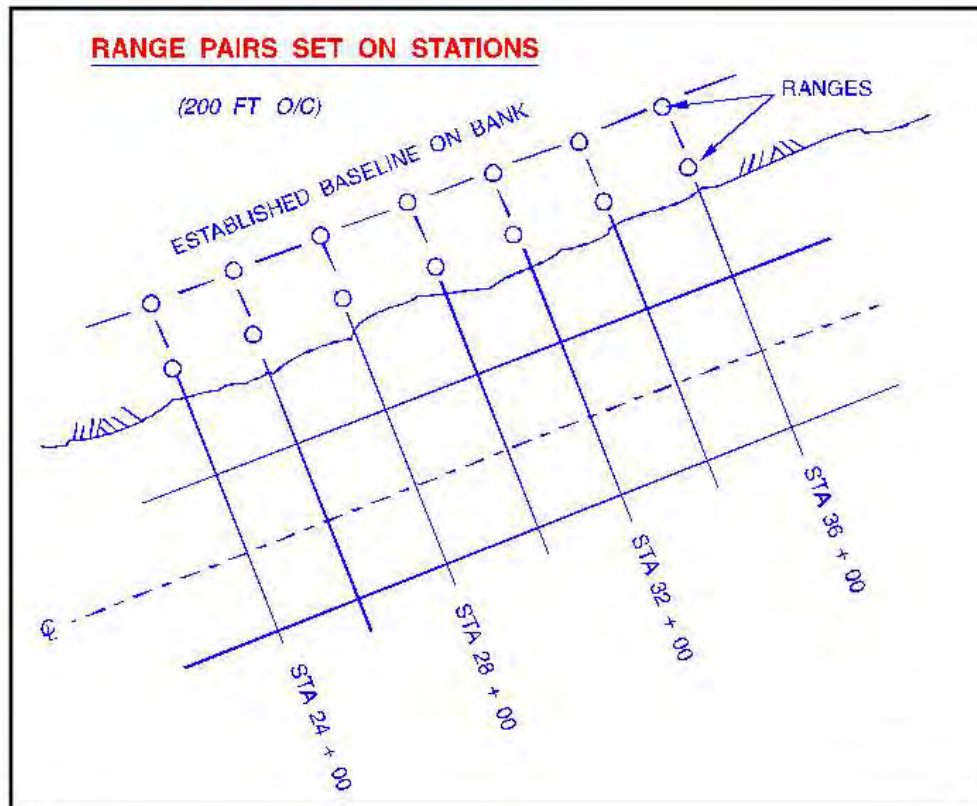

Figure G-7. Typical visual dredging range configuration.

G-12. Construction/Dredging Control Using Ranges. Offshore construction platforms, including dredges, can be effectively (and often accurately) controlled from visual ranges. Directional lasers are often used in place of range targets, and can provide both horizontal and vertical alignment to construction vehicles. In some hopper dredge work, alignment control is required only lateral to the project axis--see Figure G-7. Sets of range pairs are typically set along a canal bank or bulkhead or at the projected end of the channel. Existing sailing ranges may also be used. Normally, range pairs are established at fairly dense intervals (e.g., 100 ft O/C). The limiting factor is the distance offshore relative to the range spread. A common rule-of-thumb is that the ratio should not exceed 10 to 1. For canal or other limited area construction projects, visual alignment accuracies can be quite accurate.

G-13. Uncontrolled Project Centerline Surveys. Approximate visual positioning was once commonly used in running centerline check surveys over uncontrolled recreational projects of relatively shallow project depth. The vessel is maintained relative to the approximate center of the project using local visual navigation aids, taken from a map or other source. The lateral error is a function of the ability of the boat operator to estimate the project's center. The accuracy of the resultant profile depends on the distance between identifiable features, chart scale, constant vessel velocity, and numerous other factors. Errors could approach 100 m. However, since these relative

surveys are intended for reconnaissance purposes only, such inaccuracies may be tolerable. Any shoals encountered during these reconnaissance surveys that warrant a more detailed investigation would be developed using electronic or satellite positioning techniques. Survey data from visually controlled surveys are normally plotted in either plan or profile format, and not at a larger scale than that used to control the survey.

G-14. Accuracy and Quality Control. The accuracy of visual positioning techniques is difficult to access. Laser guided horizontal and vertical alignment can be highly accurate at reasonable distances from the target. Visual range-pair alignment accuracy is a function of the distance from the targets and the range pair spread. Positioning relative to existing map features varies with the map scale, interpolations, and feature accuracy. For these reasons, visual techniques are no longer used for navigation and dredging drawings. QA checks are rarely performed on visual positioning.

SECTION IV

Tag Line Positioning Methods

G-15. General Applications. Tag line positioning employs a calibrated wire rope stretched perpendicular from hubs on a baseline to the survey boat (Figure G-8). Up until the 1970s dozens of Corps survey crews used tag line survey methods to monitor dredging progress of navigation projects. In addition to traditional channel cross-section surveys, tag lines were employed to position floating platforms (barges) used in subsurface investigation for channel obstructions, core borings, jet probings, and channel clearance sweep surveys. In the 1970s, tag line methods were largely replaced by microwave EDM and range-azimuth techniques, which in turn were replaced by DGPS positioning in the mid-1990's. A few USACE districts have maintained a tag line survey capability for critical site investigation work; typically in areas where GPS signals are blocked, such as around berthing areas. Usually, however, an electronic total station is preferred for such surveys. A tag line survey requires no electronics or communication devices. Within limited distances off the baseline, and with proper execution, a tag line controlled survey is an accurate and stable method of performing hydrographic surveys and other investigative work for marine design and construction.

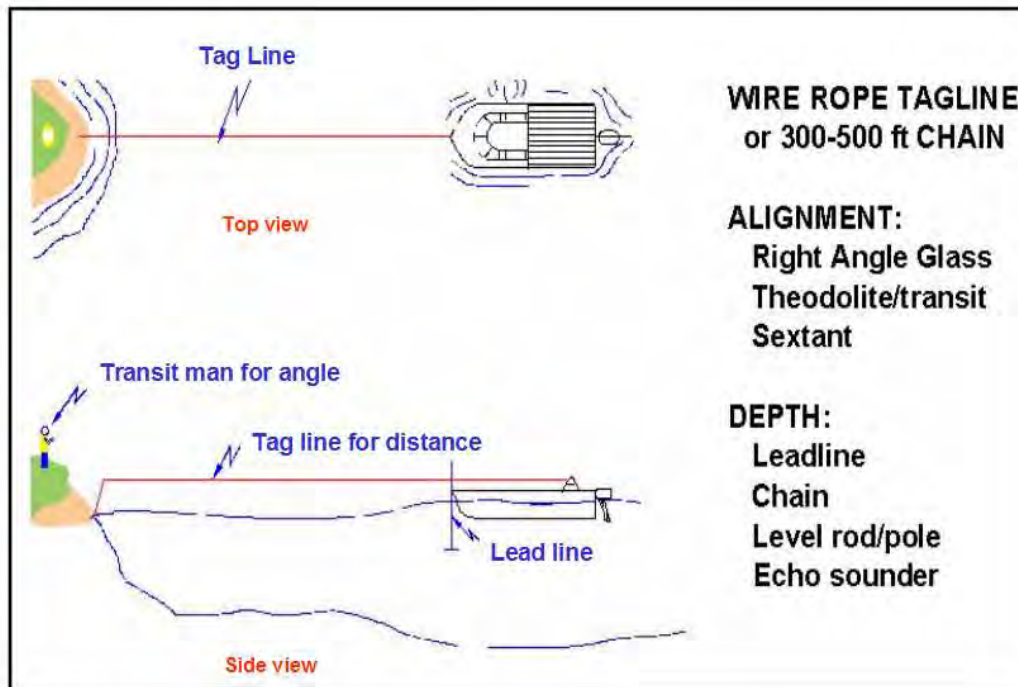

Figure G-8. Tag line surveys.

G-16. Tag Line Measurement Procedures. A tag line survey is simply a hydrographic method of running cross sections from a fixed baseline. Except for the boat and use of wire rope instead of chain, the same survey procedures are used as in highway cross-sectioning. The most accurate tag line distance measurements are conducted while the survey boat is stationary and holding constant tag line tension and alignment. Tag line surveys run dynamically (using echo sounders) are not as accurate as those conducted statically. Depths are observed with lead lines, sounding poles, level rods, or acoustically.

a. Static observations. Tag line length observations are made when the boat is properly aligned on the section and the wire is pulled taut to minimize sag. The zero end of the tag line must be firmly anchored on the baseline and held with a pole of sufficient leverage to withstand the pull from the boat. The tag line is payed out over the bow with the boat in reverse, and the winch clutch braked for each reading. The line is stopped when the interval mark is precisely at the depth measuring point on the boat (bow or transducer). The boat operator must maneuver the boat onto the proper cross-section alignment. This may be directed from ashore by hand signals or radio. Once on line, and with the tag line winch fully braked, the boat motor speed is regulated to hold the line taut out of the water and with only minimal apparent sag, at which time the depth is observed. Depending on the vessel power available and the weight of the line, the distance a tag line can be pulled fully taut will vary--pulls up to and exceeding 2,000 ft are possible. The accuracy of a tag line measurement will degrade drastically once the vessel is no longer able to provide sufficient power to suspend the line out of the water.

b. Dynamic or continuous tag line surveys. Some tag line surveys are conducted in a continuous (dynamic) mode using analog echo sounders. The boat is not stopped at tag line intervals, but the echo sounder is “fixed” at observed intervals as the reel pays out. Controlling alignment and tag line tension is not assured when this survey method is used.

c. Baseline boat tag line extension methods. Tag lines may be anchored to a floating vessel (baseline boat) that has previously been positioned by tag line or other means. Due to the compounding accumulation of error, such techniques are highly inaccurate. Since right angle prisms are typically used to hold the alignment of both the baseline boat and extended tag line boat, resultant positional errors of +50 m or more are not uncommon.

d. Other tag line survey methods. A tag line may be used to maintain a constant range from the baseline hub. The line is held taut and the boat traverses along the constant tag line arc. Position fixes along the arc may be taken with a sextant or transit. Radial tag line surveys may be conducted from a single point on the baseline, with the survey vessel progressing outward along constant radials. Substituting an electronic ranging device for a tag line provides a better distance accuracy at extended ranges. In addition to normal cross-sectioning of harbors and canals, this survey method is commonly used in running-river cross sections and offshore sections for beach renourishment studies. The electronic positioning device and orientation instrument are moved to each incremental hub along the baseline. In some cases, a radial pattern may be run from one station. The survey vessel is guided along a constant azimuth in the same manner used in tag line work. Along-track (section) distance fixes are taken visually from an automated positioning system display. The accuracy of these distance readings is a function of the positioning system's stability, its update cycle, and the velocity of the boat. Higher accuracy surveys are obtained at slower velocities.

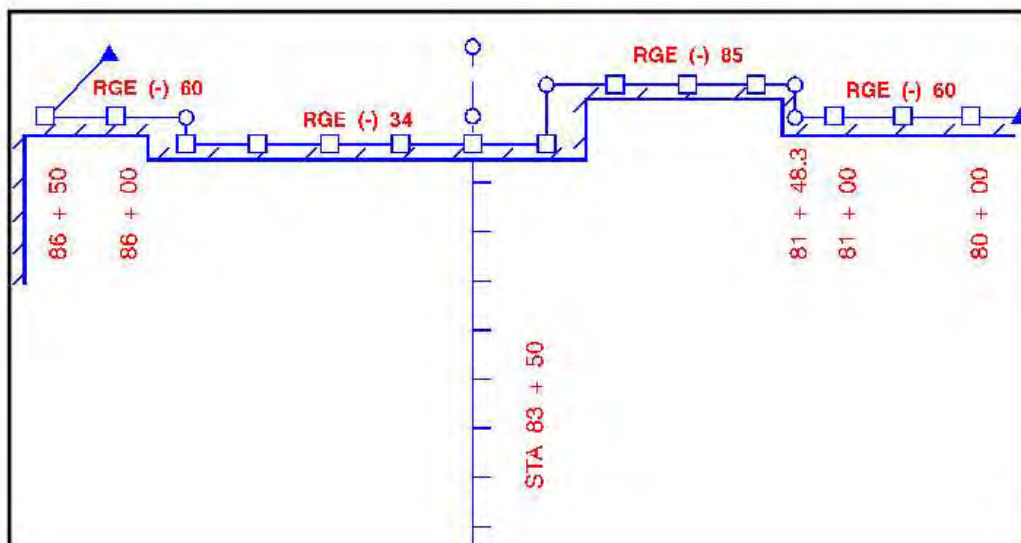

Figure G-9. Typical baseline layout along bulkhead.

e. Baseline layout for tag line surveys. Baselines for controlling tag line work are set using standard construction survey techniques and standards. Intermediate points (i.e., hubs) are surveyed at the line spacing required, usually 25, 50, or 100 ft O/C. These baselines should ideally be tied to USACE 3rd Order, Class II project control. However, 4th Order procedures may be used in setting intermediate control points along the baseline. Standard chaining or total station methods are used to lay out baselines. Baselines are normally aligned to the project's local coordinate system (station-range/offset) rather than a state plane system. See Figure G-9.

(1) Intermediate points, or hubs, may be set for permanent or temporary use. Intermediate hubs can be marked by stakes, PK nails, flagging, or any other method. Back range hubs are established behind the baseline if needed. Project stationing and range offsets should be marked on the stakes and/or painted on bulkheads facing seaward for offshore identification. Baseline hubs must be located at points that are unobstructed to seaward and where the tag line end can be firmly secured.

(2) Baselines can be established in shallow water by staking with 2- by 2-in. wooden stakes, iron pipe, rebar, etc., for tagging locations. Baselines staked in shallow water can be used by small shallow-draft workboats (outboard motor or inboard/outboard motor propulsion). The chain/weight used on the end of the tag line forming a loop will hold the tag line at the base of the stake/pipe/rebar when tension is applied to the line by the motor and braking assembly on the power/manual reel or winch. In far offshore projects, piles have been driven adjacent to the channel in order to establish a baseline.

f. Tag line alignment methods. Lateral alignment control of the survey boat can be the weakest link in the performance of tag line surveys, especially if strong currents are present. The method used to project the desired cross-section alignment (usually 90 degrees) off the baseline is also critical. Poor alignment techniques will limit the distance that a tag line cross section can be reliably projected from the baseline. Methods for holding alignment include visual range flags, right angle prisms, transits, theodolites, sextants, and total stations. The use of visual range poles or flags presumes an adequate range base is established. Right angle prisms shall generally not be used beyond 200 or 300 ft unless only rough reconnaissance surveys are being performed.

g. Data recording procedures. Tag line survey and related depth measurements may be recorded on worksheets or in a standard field survey book (Figure G-10). Survey data are plotted in either site plan or section formats.

h. Survey boats. Any size and type of boat may be used for performing tag line surveys. The most common types used in USACE are open workboats of rugged hull construction. Open boats provide ease and flexibility of tag line measurement and allow maintenance to the tag line power winches. Typical boat lengths range from 16 to 25 ft. Drafts of less than 1 ft are essential in order to work in shallow areas and to provide ease of beaching. Reinforced hulls are necessary since many tag line surveys are conducted adjacent to revetments, stone jetties, and other structures. An experienced boat operator is essential to the accurate and safe execution of a tag line survey. The operator must simultaneously maintain lateral alignment in currents, control the tag line tension, and, in some cases, operate the power winch mechanism. Lead line, sounding pole, or echo sounding depth observations are taken and recorded at the boat operator's signal. In cases in which tag line surveys are performed in navigable waters with heavy shipping traffic, the boat operator may have to release tag line tension to allow the wire to lower and rest on the channel bottom while a vessel passes.

G-17. Tag Line Equipment. Tag line surveys can be conducted using any type of continuous measuring device. Over short distances, tag line surveys may be performed using 50-ft cloth tapes or 100- to 300-ft surveyor's chains. Revolution-counting payout gages/meters are also employed. For greater distances, however, a lightweight, stainless steel (corrosion-resistant), braided cable, or wire rope (7 strand (+), 7/32-in. diameter or larger, depending on use of the tag line) is normally used. Wire rope tag line lengths vary from 500 ft to over 5,000 ft, and baseline boat tag lines from 5,000 ft to 15,000 ft long. A 2-ft loop of galvanized chain (5/8- to 3/4-in.) with a galvanized clevis and swivel should be used to connect the tag line wire to the chain.

a. Marking. The tag line cable is marked at any desired interval, usually every 25 ft. A variety of methods are used to mark and code the intervals along the tag line. Leather or plastic flagging or galvanized sleeves may be firmly crimped to the line using wire splicing/crimping tools--see Figure G-12. Strands of polypropylene rope may also be inserted through the sleeves prior to crimping. Marks are coded by color and/or size. These marks and the coding system must be readily identified to prevent reading blunders, a common problem on tag line work.

b. Swivels. Corrosion-resistant swivels are inserted along the tag line at intermediate points, usually at the 100-ft mark, the 500-ft mark, and at subsequent 500-ft intervals thereafter. The swivels help in eliminating loops (pig tails) in the wire when continuous tension is not maintained. When the line becomes slack, wire rolls and loops appear, causing crimps and breaks in the wire. The swivels also serve as checks for incremental, even, 500-ft distances.

c. Power winches. Power winches are used to reel and control tag line payout. The winches are permanently mounted amidships and may be manually, electrically, or gasoline powered. Clutching and braking assemblies in the power winches regulate tag line payout. Line payout can be alternated over the bow or stern. A guide or fair lead is used for maintaining control during payout and reeling in of the line. Hand reels or manual winches are normally used on sounding boat tag lines because of the shorter or limited wire lengths deployed. Power reels/winches are commonly used on baseline boats due to the longer amounts of line involved. Power reels should have manual

hand crank backup capability in case of power failure. Figure G-11 depicts a typical installation of a power winch aboard an open workboat.



Figure G-11. Tag line equipment aboard small 19-ft workboat. (Jacksonville District)

G-18. Accuracy, Calibration, and Quality Control Requirements.

a. Accuracy. Tag line surveys are highly accurate only within finite limits. Critical limitations include the length of extended line off the fixed baseline hub, the ability to measure and hold vessel alignment in strong currents, and the ability (power) of the boat to maintain a taut (sag-free) line over a given distance. The positional accuracy of a point positioned by tag line may be computed using the estimated accuracy of the alignment and distance measurements; similarly to that done with range-azimuth survey methods. Up to about 1,000 ft from the baseline, a tag line will maintain acceptable accuracy for dredging and navigation surveys; provided that it is pulled taut and accurate azimuth alignment is held.

b. Calibration. Flagged tag line intervals must be periodically calibrated every 3 to 6 months against a chained or EDM distance. The tag line should also be recalibrated after breaks have been respliced. Wire rope splicing must be performed so the original length is maintained as closely as

possible. Calibration is done by comparing distances of the marked intervals with corresponding distances measured with a tape or instrument of higher accuracy (Figure G-12). This is most easily performed along a pier or wharf where the tag line can be fully extended and compared with taped or EDM distances. At each marked interval on the tagline, a difference shall be observed and recorded in a field book.

c. Quality assurance. Independent checks on tag line surveys were rarely performed in practice. Occasionally, when baselines could be set on opposite canal banks, duplicate (overlapping) cross-sections could be run from opposing baselines as a check.

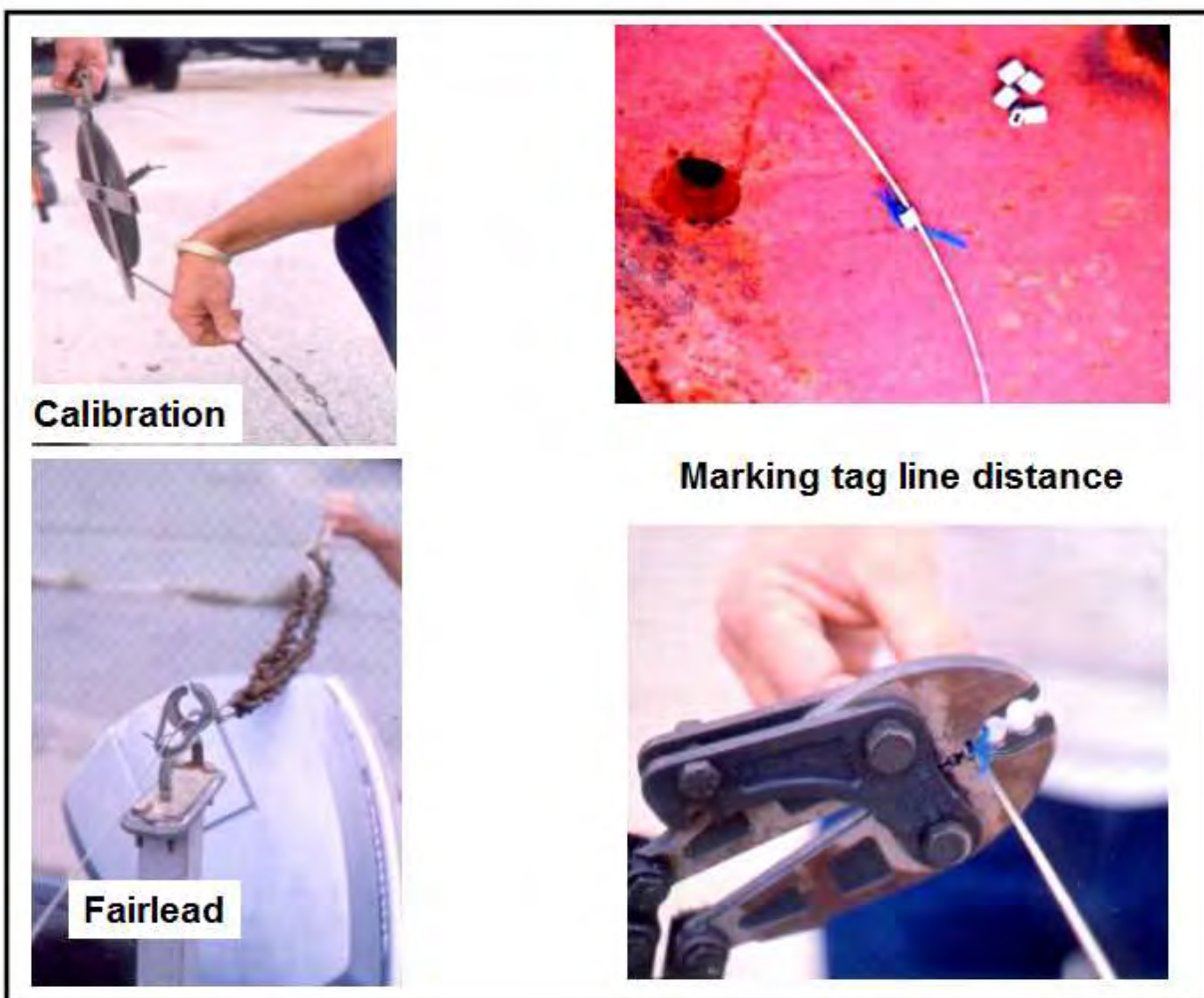

Figure G-12. Tag line marking and calibration.

SECTION V

Total Station (Range-Azimuth) Positioning Methods

G-19. General Applications. Range-azimuth positioning is most simply a forward traverse computation, based on the intersection of an angular and a distance observation, normally generated from the same shore-based reference station--Figure G-13. Angular azimuth to the offshore vessel is observed by transits, theodolites, or manually or automated tracking total stations. The angular data can be manually observed and voice-relayed to the boat by radio or digitally recorded and transmitted to the boat. The distance measurement can be made by any number of EDM devices, such as microwave, laser EDM, and infrared light EDM. Although once a widely used positioning method, range-azimuth techniques are now employed only where GPS positioning cannot be obtained—usually due to satellite blockage. Today range-azimuth surveys are mostly performed using electronic digital theodolites--i.e., total stations. Range-azimuth positioning is typically used on projects located within four miles of a shoreline or riverbank. Depending on the type of equipment used, range-azimuth surveys have high relative accuracies. Because range-azimuth positioning is nonredundant, periodic calibration is essential. This survey method is relatively efficient. Only a two- or three-man crew is required to perform the survey. Any type of boat may be used, but open or enclosed workboats 17 to 26 ft long are common. This section covers hydrographic range-azimuth positioning methods where angles and distances are obtained visually or electronically, using alidades, transits, theodolites, EDM and full electronic total stations.

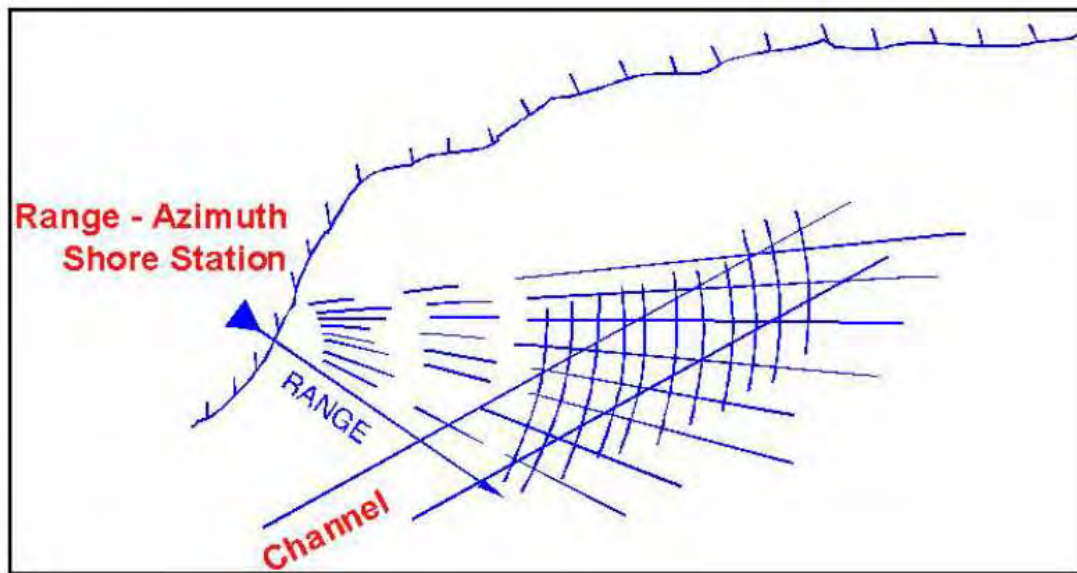

Figure G-13. Range-Azimuth positioning.

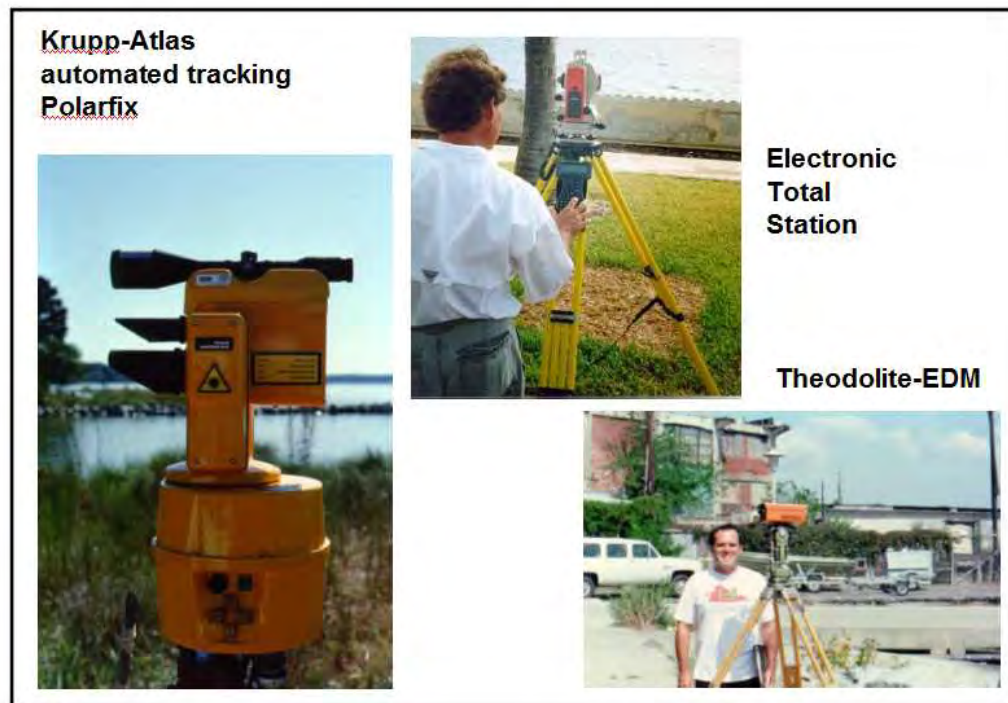

Figure G-14. Various Range-Azimuth positioning instruments used in Corps. (Norfolk District)

G-20. Range-Azimuth Survey Procedures. Total stations, theodolites, transits, or plane tables (i.e., alidades) are aligned on the local project datum in a manner similar to that described for triangulation intersection positioning (Section II). Thus, observed directions to the survey vessel are oriented in true grid azimuth reference for ease in plotting. Distances from the same point to the vessel are likewise observed, either visually (i.e., stadia) or electronically. Figure G-14 depicts some of the systems used in the Corps.

a. Manual range-azimuth tracking procedures. It is usually easiest for the tracking instrument operator to call the shot or fix events to the survey boat. The analog echo sounder record is fixed at each shot and the azimuth recorded. Constant azimuth increments may be computed based on the distance offshore. The angular spacing should conform (roughly) to the desired position fixing interval, i.e., 50, 100, or 200 ft depending on the type/class of survey. These increments are usually rounded to a convenient even value (1 min of arc or 0.01 deg) for ease of setting in the instrument. The azimuth is set in the instrument, and the vessel is tracked only for the period it is within the scope. The fix is called to the survey boat when the boat's antenna crosses the vertical crosshair. Alternatively, the survey vessel may call the fix/shot; however, this procedure requires constant tracking by the instrument man.

b. Constant range tracking. Constant circular range arcs may be tracked with fixes taken at prescribed angular (azimuth) intercepts. The boat operator follows a constant range using the microwave system display. Ranges are incremented based on the line spacing coverage desired. Azimuth intercepts to the boat are either observed at regular angle intercepts or called for by the survey boat. The observer manually tracks the boat throughout the survey and calls the observed azimuths to the boat by radio. Digital theodolites or total stations may be configured to telemeter the angular data directly to the boat. Angular intercept increments are designed to provide positions at roughly constant distances (e.g., every 100 ft) along the circular track. Thus, the angular increment will decrease as the distance offshore increases. Because the resultant data plot is along circular sections, which may not be aligned to the project, the data may not be suitable for quantity takeoffs unless DTM quantity-estimating techniques are available. This is, however, an excellent and efficient method of obtaining coverage over a given project area.

c. Separated range-azimuth reference points. The angular and distance measuring instruments need not be situated at the same point. For instance, a microwave system remote unit may be located on a sailing range structure and the tracking theodolite located at a more stable place ashore. The angle of intersection is no longer 90 deg in this case. To avoid degradation in geometry of intersection, the intersection angle should be kept larger than 45 deg within the project area. Manual tracking and positioning are accomplished in the same manner as described above.

d. Stadia distance measurement. Most traditional survey instruments are capable of determining slope/horizontal distances by tachymetric methods, i.e., using fixed cross-hair stadia intercepts. In many transits and levels with constant stadia intercept ratios, distances can be directly observed and rapidly computed by the instrumentman. Alidades typically reduce slope distances to horizontal--not required for most hydrographic applications. Visually observed stadia distances are relatively accurate over short distances--typically + 5 to +10 ft out to 300 foot distances on a dynamic platform. Beyond 300 ft to 500 ft, accuracy rapidly degrades. Ranges beyond 500 ft can be observed using "half-stadia" interval readings, and doubling the intercept value. Either level rods or painted "stadia boards" may be used for observing stadia distances. Level rod divisions are usually too difficult to read, so normally 8 to 12 ft long stadia boards are used. Boards are painted in with large black & white divisions, usually at 0.1-foot intervals, although larger intervals could be used if longer stadia distances are needed. The accuracy of observed stadia readings also degrades as vessel motion increases and visibility of the stadia board intercepts becomes obscured at longer ranges.

e. Data recording and plotting. Distances and azimuths are simultaneously observed by the instrumentman and recorded in a standard survey field book or electronic log by fix or time event. Radio contact with the vessel is maintained with the vessel normally calling for fix observations at prescribed intervals. The depth sounder is event-marked at the same time. Position data may be plotted either ashore or on the survey boat; or post plotted if real time navigation or coverage information is not required. Plane table observations are directly plotted ashore as observed. Transit-stadia observations may be plotted at either location, using drafting machines or preplotted range-azimuth sheets. If navigation guidance is needed aboard the survey vessel, then position data

must be relayed to the vessel for on board plotting. The position update interval is limited by the instrument observer's and plotter's expertise in observing, transferring, and plotting. Typically, 45 to 60 sec fix intervals are the best that can be performed in real time; thus, these methods are best for shot point depth observations under more static conditions. Total stations will typically compute and log vessel positions at a rapid update rate; however, in order to obtain real-time navigation aboard the vessel the position data must be relayed to the vessel. Manual plotting of range-azimuth surveys can be performed using a drafting machine and beam compass to lay out the azimuth and circular range arrays provided that the project area and reference station fall on the plotting sheet. If the project area is beyond the reach of these mechanical devices, the azimuth/circular array must be computed and drawn with spline curves. Angular position fixes are plotted along the constant range arc, and depth data are plotted relative to these points. Intermediate depth data points between fixes are interpolated between the fix events on the analog record. Range-azimuth position and depth data may also be encoded/digitized and plotted using automated techniques.

G-21. Total Station Range-Azimuth Surveys. Electronic total stations can be configured to provide highly accurate hydrographic positioning. The latest generation total stations can provide direct, real-time X-Y-Z coordinates on the vessel. If reflector-transducer offsets are applied, the X-Y-Z coordinate of the bottom can be computed/reduced in real-time. Robotic total stations can automatically track the vessel. A fully automated systems like the Krupp-Atlas Polarfix, contains a communications link that transmits the measured azimuth and distance to the boat. This communications data link is often the weak point in the system; care should be taken to ensure that there is no interference from other sources. These data are transformed to a local project coordinate system (station-offset, beach/river profiles, etc.) which is used for vessel operator steering guidance on a digital or analog left-right indicator. Topographic or construction total stations must be modified for hydrographic tracking applications if the beam width is not large enough to track the vessel. Philadelphia District has modified conventional topographic total stations for hydrographic survey purposes. Topographic total stations must also be configured to relay navigation data (via radio communication link) to the survey vessel processor for navigation and data logging purposes. Without on board navigation links, total stations are usually set up over established ranges--a common procedure for beach sections.

G-22. Range-Azimuth Accuracy. The accuracy of a range-azimuth position can be estimated from the following equation:

$$\text{RMS 95\%} = 1.73 \cdot \text{sqrt} [a^2 + (d \cdot \tan b)^2] \quad (\text{Eq G-3})$$

where

a = estimated standard error (1-sigma) of the distance measuring system (e.g., tag line, EDM, stadia)

d = distance offshore

b = estimated standard error (in arc-sec) of azimuth measuring system (e.g., total station, right angle glass, transit, sextant)

Within a few hundred feet from the instrument, theodolite/EDM/total station range-azimuth systems are highly accurate for dredging and navigation surveys. Microwave based EDM will rarely meet current 2 m or 5 m positional accuracy standards. Dynamic alidade or transit stadia distances are accurate to 5 m within ranges of only 100-200 ft, depending on conditions.

G-23. Quality Control Requirements.

a. Angular orientation. The tracking instrument should be referenced to the grid azimuth for the project. This is accomplished by setting the lower plate to the grid azimuth of the reference backsight. The farthest or most reliable point should be selected as the reference orientation. Additional reference points should be pointed on to verify orientation. All available visible control should be sighted on, and any error or discrepancy resolved onsite. All orientation checks (including grid azimuth computations) must be recorded on a worksheet or field book.

b. Periodic orientation checks. During the course of the survey, the initially set orientation should be periodically checked to ensure that no movement in the instrument has occurred. Periodic orientation checks should be noted in instrument operator's field book. These checks are normally done at the end of each survey line. The instrument should be readjusted and releveled as required during these checks. If significant movement has occurred, all work done since the last orientation check was made should be rejected and rerun.

c. Quality assurance checks. Like most visual survey positioning methods, independent positional checks on range-azimuth positions are rarely available. When the vessel can be maneuvered to another project control monument, a check on the position can be made. This should always be done for critical navigation surveys.

SECTION VI

Terrestrial Electronic Positioning Systems

G-24. General Scope. Use of electronic distance measurement (EDM) techniques to position hydrographic survey vessels derived from hyperbolic aircraft navigation systems first developed during World War II. The Corps first began using hyperbolic and range-range electronic positioning during the mid 1950's--in Detroit and Norfolk Districts. A variety of systems have been used since that time; most of which became quickly obsolete when GPS became fully operational. However, the basic operating concepts behind land-based EDM and related trilateration positioning (including GPS) have not significantly changed. This section describes these electronic distance measurement and positioning principles of these older land-based electronic positioning systems; including procedural criteria for using such systems. Land-based (or terrestrial) positioning systems are distinguished from satellite (extra-terrestrial) positioning systems. All these systems use time difference and trilateration techniques to determine a position. The main focus of this section is on land-based microwave positioning systems as opposed to now nearly obsolete low- or medium-frequency hyperbolic systems such as LORAN-C.

G-25. Types of Electronic Positioning Systems. One method of classifying electronic positioning systems is by their operating frequencies. The frequency generally determines operating range and accuracy, and, in turn, a system's applicability for a particular type of work. Figure G-15 lists some types of electronic positioning systems by their bandwidths. In general, the higher the frequency of the electronic positioning system, the more accurate the resultant position determination. Systems in the medium frequency range and below are typically hyperbolic phase/pulse differencing, and can reach far beyond the visible or microwave horizons. These systems were more suited for long-range navigation purposes or far offshore geophysical exploration work. Only those systems operating above the medium frequency bandwidth range had any practical application to USACE construction work. Microwave systems in the Super High Frequency (SHF) range were most commonly used to precisely control offshore survey vessels and dredges. Operating distances for these systems are generally limited to line of sight, which is adequate to cover most river, harbor, and coastal construction applications. Modulated lightwave and infrared spectrum electronic distance measurement instruments (e.g., electronic total stations) can be used over relatively limited distances, usually less than 3 to 5 miles offshore. These systems provide the highest distance accuracy measurements.

<u>Bandwidth</u>	<u>Symbol</u>	<u>Frequency</u>	<u>System</u>
Very Low Frequency	VLF	10-30 KHz	Omega
Low Frequency	LF	30-300 KHz	LORAN-C
Medium Frequency	MF	300-3000 KHz	Raydist, Decca
High Frequency	HF	3-30 MHz	Fundamental Earth Frequency 10.23 MHz
Very High Frequency	VHF	30-300 MHz	VOR Aircraft Navigation
Ultra High Frequency	UHF	300-3000 MHz	Del Norte
L-Band			NAVSTAR GPS
Super High Frequency	SHF	3-30 GHz	(Microwave EPS)
C-Band			Motorola
S-Band			Cubic
X-Band			Del Norte
Visible Light			EDM*
Laser Light			EDM
Infrared Light			EDM, Polarfix

Figure G-15. Frequencies of various positioning systems used for hydrographic surveying (1950 to date).

a. Medium-frequency positioning systems (RAYDIST/DECCA). Raydist and Decca positioning systems were first deployed by Corps districts in the mid 1950's and were used up to the

early 1970's. They are no longer used. Systems in this frequency range operated by time/phase differencing methods--resulting in either circular or hyperbolic lattices (time differences). These systems required repeated calibration to resolve whole-wavelength (lane) ambiguities and continual monitoring during the course of the survey to resolve lane, or cycle, slips--no different than integer ambiguity determination requirements for modern day carrier phase GPS observations. Onsite calibration was essential to maintain accuracy. However, given the far offshore uses of these systems, calibration was often impossible. Many of the visual positioning techniques described in previous sections were used to calibrate these systems.

b. Low-frequency positioning systems (LORAN-C). LORAN-C is a low-frequency time-differencing hyperbolic system and has been the primary marine and airborne navigation system for over 40 years. It is suitable only for general navigation or reconnaissance surveys; and perhaps for general dredge/dump scow monitoring. Daily near-site or onsite calibration is critical if any semblance of absolute accuracy is to be maintained. (This is not the same as relative accuracy.) Without onsite calibration, absolute positional accuracy of LORAN-C is

+ 0.25 mile at best. Recently developed differential Loran-C has a much higher accuracy. LORAN-C is expected to be decommissioned by the US Coast Guard in the early 2000's.

G-26. EDM Measurement Process. Most EDM systems operate either by resolving two-way travel phase delays of a modulated electromagnetic carrier pulse/wave between the offshore vessel and shore-based reference transmitter or by measuring the two-way travel time of a coded electromagnetic pulse between these points. GPS operates in a similar manner to the conventional systems except the travel distances from the satellites are one-way. Code-phase GPS is similar to microwave coded pulse systems, and carrier phase GPS operates on the carrier wave (phase differencing) used to transmit coded information. Phase differencing techniques are also used on land surveying EDM instruments, with the carrier being a visible laser or infrared light. Microwave pulsing type systems (Motorola, Del Norte, Micro-Fix, etc.) measure the round-trip travel time of a pulse generated at the offshore vessel, to the shore repeater station, and back to the vessel. The remote shore stations are variously referred to as transponders (XPDR), trisponders (TPDR), or responders (RPDR), depending on the manufacturer. They receive, process, and retransmit the signal. Some microwave systems use passive radar reflectors. For a pulsing system, the round-trip distance is computed by multiplying the measured elapsed time (less internal system time delays) by the assumed velocity of propagation of electromagnetic energy. The distance, or range, is computed by the following equation:

$$d \text{ (meters)} = c \cdot (t_m - t_d) / 2 \quad (\text{Eq G-4})$$

where

c = assumed velocity of propagation (m/sec)
 t_m = measured round-trip travel time (sec)
 t_d = internal system delays (sec)

a. Distance determination. Under ideal conditions, and with repeated measurements, the travel time (t_m) can be measured fairly accurately (to better than the 1-nsec (1-ft) level) and far more accurately (sub-centimeter) when modulated phase comparison techniques are employed, such as on infrared and some microwave systems. However, all three factors on the right side of Equation G-4 are subject to both random and systematic errors. The only way to minimize these errors is by external and internal calibration of the equipment. Internal system delays (t_d) can be controlled relatively effectively on some modern pulsing systems. Such control is often termed "self-calibrating." The assumed velocity of propagation (c = speed of light) and other local anomalies or inherent system measurement instabilities cannot be controlled or corrected by the measurement system. Thus, an independent, on-site calibration must be performed if errors due to these sources become significant, which is normally the case (i.e., ambient project conditions different from nominal conditions). As a result, a calibrated microwave positioning system operating in a dynamic hydrographic survey environment can measure a range to an accuracy ranging between + 3 m and + 10 m (95% RMS).

b. Velocity of propagation variations. Variations in the velocity of propagation in air are caused by changes in air density due to temperature, humidity, and air pressure. The effect on land-based microwave positioning systems is more pronounced than on light waves. A factory-calibrated microwave system may be operated in atmospheric conditions differing significantly from the nominal calibration conditions. A change of 50 to 75 ppm could result, or 0.5 to 0.75 m in 10,000 m. Although such a variance may not be significant in operations 6 miles offshore, it is a systematic error, which could be compensated for by proper calibration. Assumed stability in the pulsing system time ($t_m - t_d$) or phase measurement process cannot be guaranteed. Periodic independent calibration is essential to check this stability. No independent calibration of positioning systems is totally effective unless it closely duplicates the actual operating ranges and conditions.

c. Microwave antenna considerations. Microwave propagation/refraction problems may exist in some areas during hydrographic surveys. Moving antennas a small distance (vertically or horizontally) sometimes eliminates the problem. Weather, especially humidity and temperature, affects microwave propagation through the air. Large ships, metal buildings, and even the water surface can create unwanted reflections of the microwave signals received at the antenna. Experience with microwave equipment problems and knowledge of the survey area will minimize the recurrence of these types of problems. Different antennas may be used to either boost a signal into a sector (sector antenna) or allow transmission over a full circle (omnidirectional) from the station. Circular polarization is another technique used to reduce multipath effects. Another technique used is antenna separation, which switches from one antenna to another to reduce multipath phenomena. GPS manufacturers use concentric metallic raised rings surrounding the antenna to reduce multipath effects.

d. Multipath effects. Signal multipath reflection is a major systematic error component for equipment operating in the microwave band. Errors due to this effect are difficult to detect. Most critically, they can gradually accumulate with vessel location and orientation relative to a particular remote reference station. An abrupt change due to multipath is usually readily apparent, as is total signal cancellation, termed "range holes." This gradual range increase of 1 m or more can cause

what appears to be a course anomaly on a plot of the vessel's position, as if some erratic current displaced the vessel for a period of time. In addition, multipath may be present when the system is calibrated at a particular point. Consideration of multipath during antenna placement, enhanced antenna design (circular polarization, space diversity, etc.), and other internal electronic techniques and filters are required to identify and/or minimize multipath effects. None are totally effective in all cases. Antenna spacing or systems with circular polarization are recommended to minimize the possibility of these effects.

G-27. Microwave Range-Range Positioning Systems. These systems were first used by Corps districts in the early 1970's. The first systems were manufactured by Cubic Corporation, Motorola, and Del Norte Technology. They effectively replaced tag line and medium frequency (Raydist and Decca) positioning methods that had been used by districts since the 1950's. Up until the mid 1990s, microwave positioning systems were the primary positioning system in nearly every district. After 1992 when full coverage differential GPS became available, use of microwave systems rapidly declined. In 1998 only one or two districts were still utilizing microwave positioning--all the others have gone exclusively to GPS positioning. It is unlikely such systems will be in use much after 2000. Range-range positioning by microwave systems is accomplished by determining the coordinates of the intersection of two (or more) measured ranges from known shore control points--a process termed trilateration. When two circular ranges are measured, two intersection points result, one on each side of the fixed baseline connecting the reference stations. The ambiguity is usually obvious and is controlled by either initializing the computing system with a coordinate on the desired side of the baseline or referencing the point relative to the baseline azimuth. Prior to automated data acquisition systems, microwave ranges were visually observed and steered, with data logging and plotting performed manually. As automated data acquisition systems began to be used in the early 1970s, ranges and computed positions were electronically recorded and the resultant position sent to a track plotter and helmsman guidance display unit. These microwave range-range positioning methods used by the Corps during the period from about 1970 until 1999 are described below.

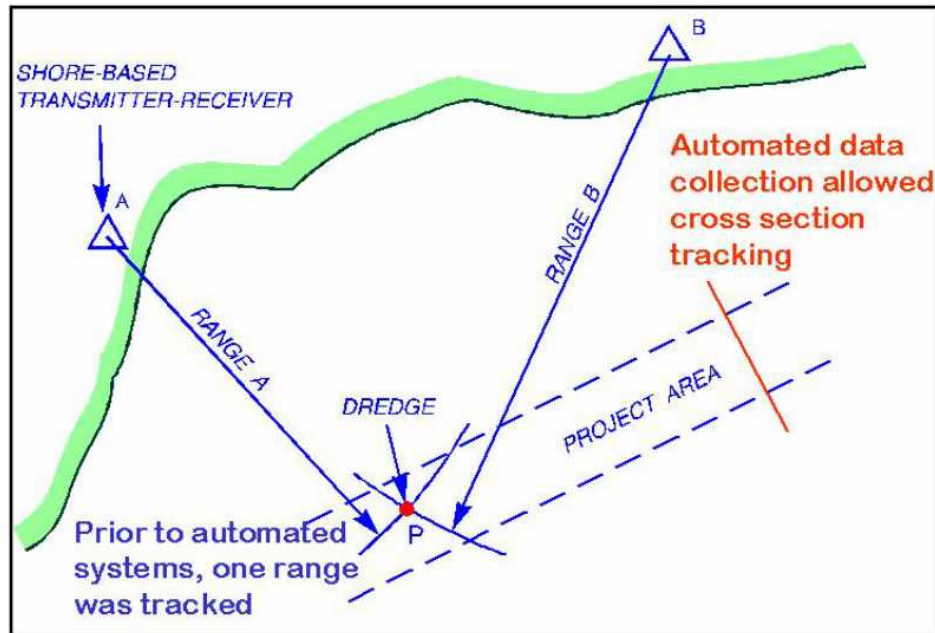

Figure G-16. Range-Range intersection.

a. Constant range tracking. Before automated data logging and processing systems were available, the survey boat was positioned by steering a constant range from one reference station and fixing at range intercepts from the other reference station (Figure G-16). At higher vessel velocities, this is not an accurate positioning method, due to the need to estimate the intercept between range updates. In addition, the resultant survey lines are circular and are not aligned to the project coordinate system. This survey method provided a good backup capability when failures occurred in automated positioning and guidance systems. It was rarely employed, however.

b. Automated range-range tracking. When automated positioning and guidance systems were employed, the range intersection coordinates were automatically computed and transformed relative to the project alignment coordinate system (station-offset). This data was then fed to an analog or digital course indicator (or left-right track indicator), allowing any particular station/cross section or offset range to be tracked. Along-track position fixes were then taken by manually observing an along-track indicator or track plotter. The analog depth recording device is marked at each position. Normally, however, digitized depth data are correlated with positional data in an automated system at regular preset intervals by time or distance. Figure G-17 shows typical electronic ranging and positioning equipment used by the Corps during the past 30 years.

c. Range-Range accuracy. The positional accuracy of a range-range intersection position is a function of the range accuracy and the angle of intersection of the ranges. The angle of intersection varies relative to the baseline so the positional accuracy varies as the survey vessel changes location. Assuming both ranges have equal value, the positional accuracy at any offshore point can be

estimated from:

$$\text{RMS (95\%)} = 2.447 \cdot \sigma \cdot \text{cosecant (A)} \quad (\text{Eq G-5})$$

where

σ = estimated standard error of measured range distance (1-sigma)

A = angle of intersection of ranges at vessel (or angle from vessel to baseline stations)

Since the angle of intersection (A) has a major effect on positional accuracy, quality control criteria will restrict surveys within intersection tolerances--e.g., A must be between 45 deg and 135 deg. The accuracy of microwave ranges is difficult to estimate since it is not constant with distance from a shore station. Manufacturers typically claimed accuracies of + 1 m (1-sigma), or + 2 m (95% RMS). These estimates were for ideal (calibrated) conditions. More likely microwave range accuracies were on the order of + 3 m. This would yield an average positional accuracy of about 8 m (95% RMS) at 60 deg range angle of intersection. Although an 8 to 10 m RMS error may seem excessive by today's DGPS or RTK standards, this represented a major improvement in the 20 to 50 m accuracies achieved by earlier positioning methods--especially on a project site 10 miles offshore.

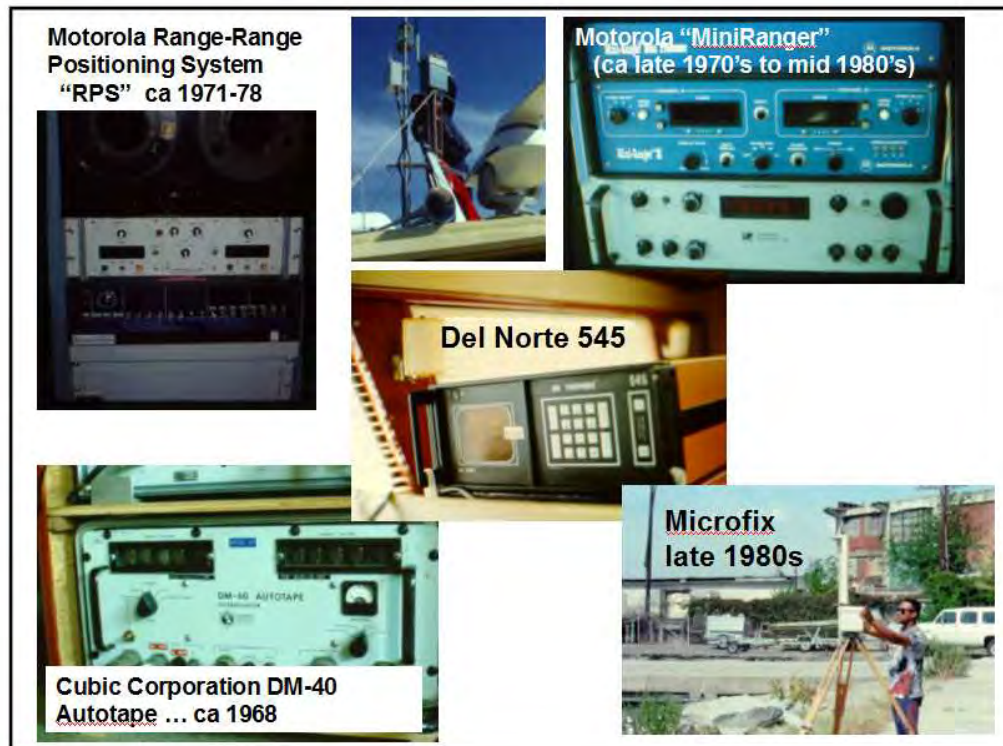

Figure G-17. Range-Range positioning systems used in Corps (1970-1995).

d. Multiple range positioning techniques. This method is simply an expansion of the range-

range method described above. Jacksonville District first developed this technique in 1979. In this case, three or more ranges are simultaneously observed, and a positional redundancy results. (The Racal Micro-Fix system allowed selection of up to 8 ranges from a total of 32 interrogated.) The position is determined from the computed coordinates of the intersections of the three or more range circles. Since each range contains observational errors, all the circles will not intersect at the same point. In the case of three observed ranges, three different coordinates result. Four ranges result in six separate coordinates. The final position is derived by an adjustment of these redundant coordinates, usually by a least-squares minimization technique. Some automated microwave positioning systems simply used the strongest angle of intersection as the "adjusted" position, and others take the unweighted average of all the intersecting coordinates. All adjustment methods were typically performed on-line at each range update cycle, normally every second. The positional data are then transformed to a project-specific coordinate system in a manner similar to that described for a two-range system.

(1) Using multiple ranging can minimize positional uncertainties. The coordinated position contains redundancy and can be adjusted. Such a process reduces the geometrical constraints and provides an opportunity to evaluate the resultant positional accuracy as the survey progresses. An on-line accuracy assessment is thus provided. This is accomplished by evaluating the positional misclosure which occurs when three or more position lines containing errors intersect, a so-called triangle of error for the simple case of three intersecting ranges, as shown in Figure G-18. The position of the vessel is obtained by adjusting the three ranges to a best fit.

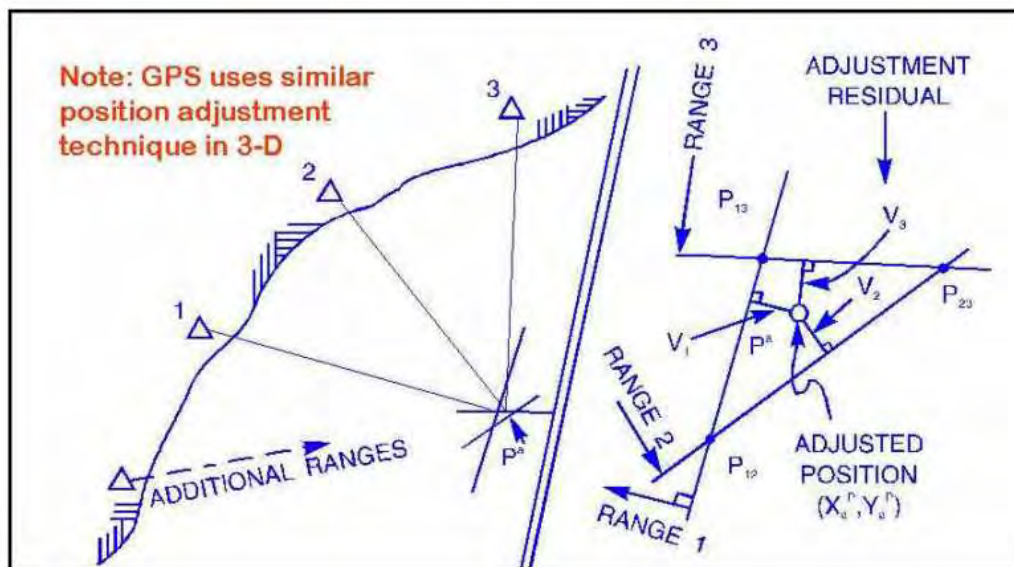

Figure G-18. Multiple range positioning.

(2) An assessment of the range measurement accuracy may be obtained by computing the residual range errors (v) for each position. These are the corrections added to each range so that all

ranges intersect at the same point. When a least-squares type of adjustment is performed, the sum of the squares of the residual errors (v) is made a minimum. The magnitudes of these residual range corrections provide the statistics for an accuracy estimate of the observed distances or, more practically, an approximate quality control indicator. When a least-squares adjustment is performed, it is possible to obtain an accuracy estimate of the positional RMS error. Automated software can provide such data at each position update. If known, different weights may be assigned to individual range observations. This proved useful when different types of positioning systems were mixed during a survey (i.e., microwave and medium wave ranges).

(3) An on-line quality control indicator (e.g., 95% RMS error) can be computed. This can be directly obtained from the least squares adjustment matrix and computed from:

$$\text{RMS Error (95\%)} = 1.73 \cdot \text{sqrt} (\sigma_x^2 + \sigma_y^2) \quad (\text{Eq G-6})$$

where

σ_x and σ_y = estimated positional standard errors in x and y coordinates (from variance-covariance matrix)

Automated systems were designed to alarm when positional RMS accuracies fell outside the prescribed limits, indicating calibration problems. The initial standard error of the microwave ranges was usually assumed constant throughout the survey.

(4) Alternatively, the residual range errors (v), which result from comparing the observed distances with the inversed distances between the adjusted position and the remote shore transmitters, could be used to evaluate the accuracy of the range measurements. A variety of methods were used (on-line and/or off-line) to compute these residual errors. An approximate (unbiased) estimate of the range accuracy is obtained from the following:

$$\text{Estimated Range Accuracy (1-}\sigma) = \text{sqrt} [\Sigma (v^2) / (n-1)] \quad (\text{Eq G-7})$$

where

n = number of observed ranges
 $\Sigma (v^2)$ = sum of the squared residuals

Adding redundant ranges will not necessarily make a significant improvement in the positional accuracy because the inherent random and systematic errors are still present. It will, however, help detect the existence of large systematic errors (and most critically, observational blunders) that might have otherwise gone undetected using a nonredundant range-range system.

(5) Figure G-19 demonstrates the use of multiple ranging in an offshore location where no independent method of calibration at the job site was available. Figure G-20 shows another project with six intersecting points, resulting from the four observed ranges. Error ellipses for each of the

two-range intersections are shown. The on-line least-squares adjusted position is shown along with its (smaller) error ellipse.

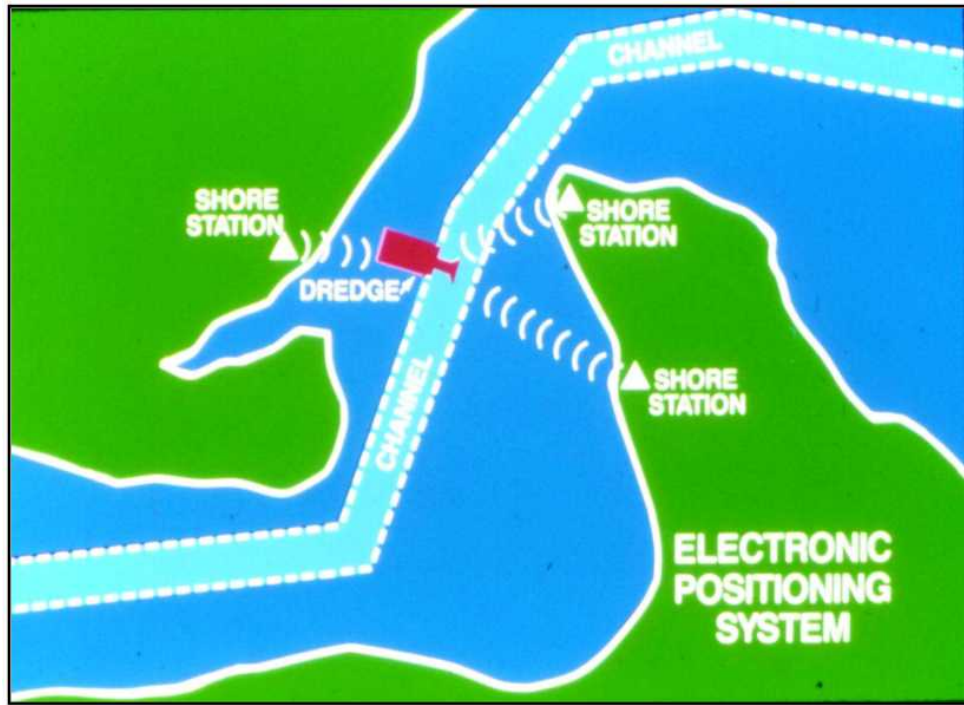

Figure G-19. Three-range microwave positioning scheme.

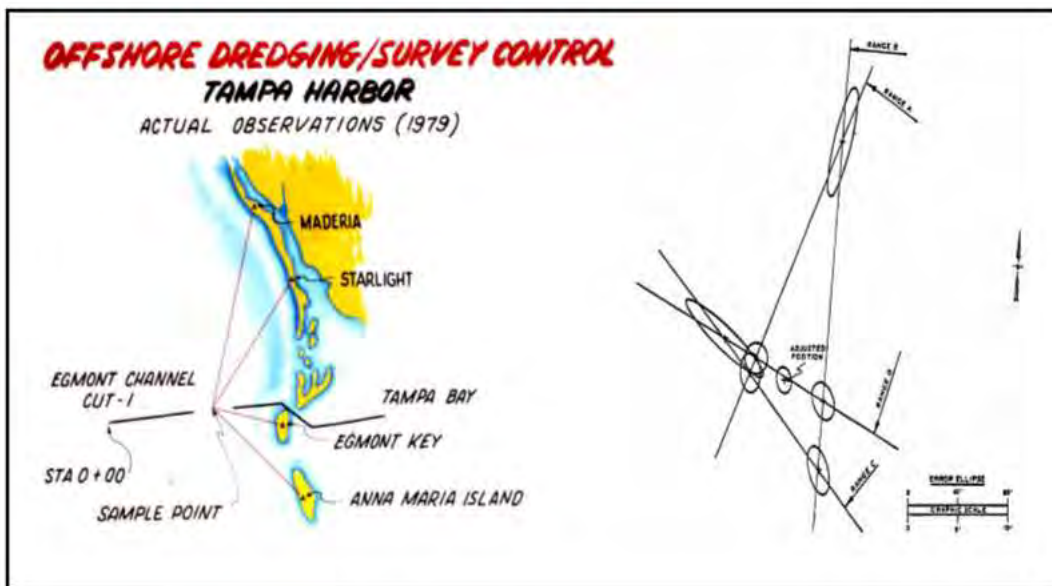

Figure G-20. Four-range intersection position solution (Tampa Harbor, Jacksonville District).

G-28. Microwave System Calibrations and Quality Control. A microwave system calibration

process basically involves an independent determination of the vessel's antenna location, followed by comparison of differences between the observed microwave ranges and the distances computed from the independent calibration. An independent calibration should be at least one order of magnitude more accurate than the microwave system being calibrated. Such systems would include: theodolite triangulation, total station observations, or EDM trilateration methods. If automated coordinates are observed rather than direct ranges, inverse coordinate computations will have to be made to determine the observed ranges. If a series of independent calibrations is made, the mean range difference over this series represents a correction to be applied to the system. This range correction is dialed in the microwave system range console or is stored for software application during the position computation. Given the instability of many microwave ranging systems, coupled with inaccuracies in the calibration process itself, determining whether a range correction is statistically valid is difficult. This problem frequently occurs when baseline comparisons are made at two (or more) different calibration points offshore.

a. Repeated calibrations. An advantage of EDM, total station, sextant, or triangulation intersection calibrations is that a series of 5, 10, or more independent calibrations may be obtained at various locations in the work area. If the calibration technique is performed accurately, the mean range difference correction may be statistically valid. Its validity is best estimated by computing the standard deviation from the mean of the series of range differences. Applying a calibrated range difference may often be debatable from a statistical standpoint. For example, assume that a microwave range is calibrated by five independent distance measurements. The accuracy of the calibration process is estimated at ± 0.5 m and the range is presumed stable to $+0.5$ m. The series of calibrations yields a (-) 0.3-m correction ± 1.0 m. The ± 1.0 -m deviation contains the error budget of the microwave range, the calibration process, and other unknown factors (control, eccentricities, etc.). A (-) 0.3-m correction in this case would seem marginal. However, for consistency, it should be applied since no simple rule-of-thumb exists for deciding when such a correction is statistically valid.

b. EDM calibration. Direct ranges to the shore-based receiver stations may be observed using precise phase differencing laser/infrared electronic distance measurement instruments. Typically, the EDM is moved to the two or more receiver monuments, and the reflector prism is placed above or below the vessel's antenna. Depending on the type of EDM used, vessel stability is critical for maintaining lock on the reflector. A series of EDM distance readings is directly compared with the simultaneously observed microwave ranges, and corrections are assessed as described above. EDM observations are taken and corrected for slope and atmospheric refraction in accordance with standard survey methods. If control monuments other than the microwave remote receiver's are occupied, a trilaterated position of the vessel must be determined and inverted along the microwave ranges for comparison. This method is especially suitable for periodic calibration of dredges.

c. Baseline calibrations. Baseline calibrations are performed by locating the survey vessel alongside a known reference point and comparing the computed (inversed) distances with the ranges observed by the microwave system. This is the simplest and most common microwave calibration

method. Any eccentricities between the vessel's antenna and the known monument must be corrected. This is usually done by observing an angle and taped distance from the reference point to the antenna and computing the grid coordinates of the actual antenna. A sextant bearing is adequate over short distances. In some instances, the vessel antenna may be removed from its mounting and placed directly over the known monument. Such a procedure may change antenna receiving characteristics and induce multipath error. Some automated systems allow input of the antenna coordinate and directly compute the distance comparisons or, alternatively, directly correct the observed ranges to agree with the fixed coordinate. (This latter method assumes only one calibration check will be employed--or the differences from different points are insignificant.) Such a process is useful on multiple ranging systems. Regardless of the method employed, a few minutes of observations should be recorded. Lengthy calibration observations at the same point serve no purpose other than measuring the system's precision (not accuracy) at that particular point. Range corrections are computed and assessed. For critical surveys, the same process should be performed at a second calibration point. Significant differences in the range corrections for each point may indicate problems with the control network, multipath errors, or both. The magnitude of the recorded range differences from each calibration point is another rough indicator of the quality of the survey. If the magnitude of these differences (or standard errors from the mean values) is significant, the source of the problem must be determined. This may require calibration at a third fixed point.

d. Total station instrument calibration. Since a typical total station EDM yields direct and accurate X-Y-Z coordinates of the remote point, it may be used to compare the coordinates of an automated positioning system. A total station may be set up at any known point with visibility to the offshore point (and within the operation ranges of both systems). With the vessel held as motionless as possible, the retro-prism is held adjacent to the microwave system antenna, and simultaneous total station and microwave system coordinates are observed at different locations. Inversed distances and microwave ranges are compared as shown in previous examples.

e. Triangulation intersection. Triangulation methods are suitable for areas where no onsite calibration points are available. This method is also particularly ideal for calibrating dredges and other large plants that cannot perform static or direct baseline calibrations. Triangulation methods are potentially the most accurate form of microwave calibration in that the process is performed in a dynamic (true working) environment. To attain this, however, excellent intersection geometry and visibility are necessary, and highly skilled theodolite tracking observers are essential. Vessel velocity must be kept at a minimum during the tracking process. For high-accuracy triangulation calibration, a third theodolite is added for redundancy. A series of 5 to 10 or more intersection fixes is made on a stable or slowly moving survey vessel or dredge at or near the work area. Microwave ranges are read at the time of each intersection fix. Triangulated positions are computed for each position, inversed, and compared with the observed range. Care should be taken to ensure that all computations and comparisons are based on grid distances. As described previously, based on the deviations in the range differences, a judgment must be made as to whether the mean range correction is statistically valid.

f. Sextant resection. Sextant resection calibrations are valid only when resection geometry is ideal, for nearshore projects where distinct sextant targets are clearly visible and vessel velocity is near dead slow or stopped. A series of 5 to 10 simultaneous sextant resection angles and microwave range observations should be made. The sextant observers must be centered about the microwave antenna to minimize eccentricities. On a stable or spudded platform, redundant angles should be observed. Resection computations should be performed manually or with standard software. Graphical resection (three-armed protractor plots) shall not be used. Resection software should provide an estimator or indicator of the quality of the resection based on the geometry and estimated standard error of the observed angles. Without such a quality estimate, the resection solution may be less accurate than the microwave solution. Resected grid coordinates are inversed and compared with the observed microwave ranges. Range differences for each position are computed and meaned. A standard error of each mean should be computed to judge whether applying a mean correction to the range is statistically appropriate. Large variances between the resected ranges and the microwave range indicate poor resectioning, unstable microwave ranges, or both.

g. General QC criteria for electronic positioning systems. Some basic criteria for performing positioning system calibrations are described below. Some of these factors are also applicable to GPS positioning techniques.

(1) The independent calibration procedure used must have an accuracy at least equal to or better than the system being calibrated. This is not always easily accomplished when dynamic calibrations are performed.

(2) Multipath effects may not be eliminated by calibration since they can depend on the antenna location (ashore and afloat) and the orientation of the offshore vessel.

(3) A static calibration does not simulate the dynamic survey condition. Thus, any errors due to vessel motion will not be picked up (e.g., electromechanical lags or lack of system synchronization--latency errors).

(4) Calibrations must simulate, to the maximum extent possible, the actual conditions existing in the project area. This requires calibration as close to the work site as possible.

(5) Measurement systems known to be relatively stable, such as infrared electronic distance measurement devices, "self-calibrating" or phase comparison microwave systems, total stations, and GPS, must also be independently checked, or verified, to prevent blunders. The frequency of such verification checks is more relaxed for these systems.

(6) Calibrations of pulsing microwave positioning systems are valid only for the particular range measurement system used. When antennas, receiver units, connecting cables, and the like are modified, moved, or swapped out, a full recalibration of the system must be performed. Calibration must be performed while the shore-based receivers are located at their actual sites and referenced to the permanently located vessel antenna. If not, some large systematic effects may not be properly

EM 1110-2-1003

30 Nov 13

compensated for.

(7) Calibration procedures must be consistent during the course of a project (i.e., both pre-dredge and after-dredge payment surveys). The same baselines and/or procedures should be employed.

(8) Remote points used to calibrate an established network must be adequately connected by surveys relative to the positioning network. This is especially important when calibrating from large offshore range structures which may not have been accurately positioned, or where the center point is not easily defined. This is especially applicable to long-range DGPS/RTK observations.

APPENDIX H

Kings Bay Entrance Channel Tidal Modeling for RTK Surveys (Jacksonville District)

H-1. Background. This section details the 1997 implementation of the first permanent real-time kinematic (RTK) network in USACE. This network was utilized for real-time water surface elevation measurement and to develop variations in the tidal datum in the Saint Mary's Entrance Channel. Observed RTK ellipsoid heights are reduced to a filtered water surface elevation and corrected to the local MLLW tidal datum. This single station RTK network has been continuously utilized since 1998 for all dredging and surveying operations. It is still operational as of 2013. The channel is located at the boundary between the States of Florida and Georgia and provides access to the Kings Bay FBM Submarine Base, Georgia. The Entrance Channel is maintained to a project depth of over 46 feet--out to the east channel limit eight miles offshore--Figure H-1. The project has an approximate tide range of 7 ft and has always been difficult to survey due to uncertain tidal modeling.

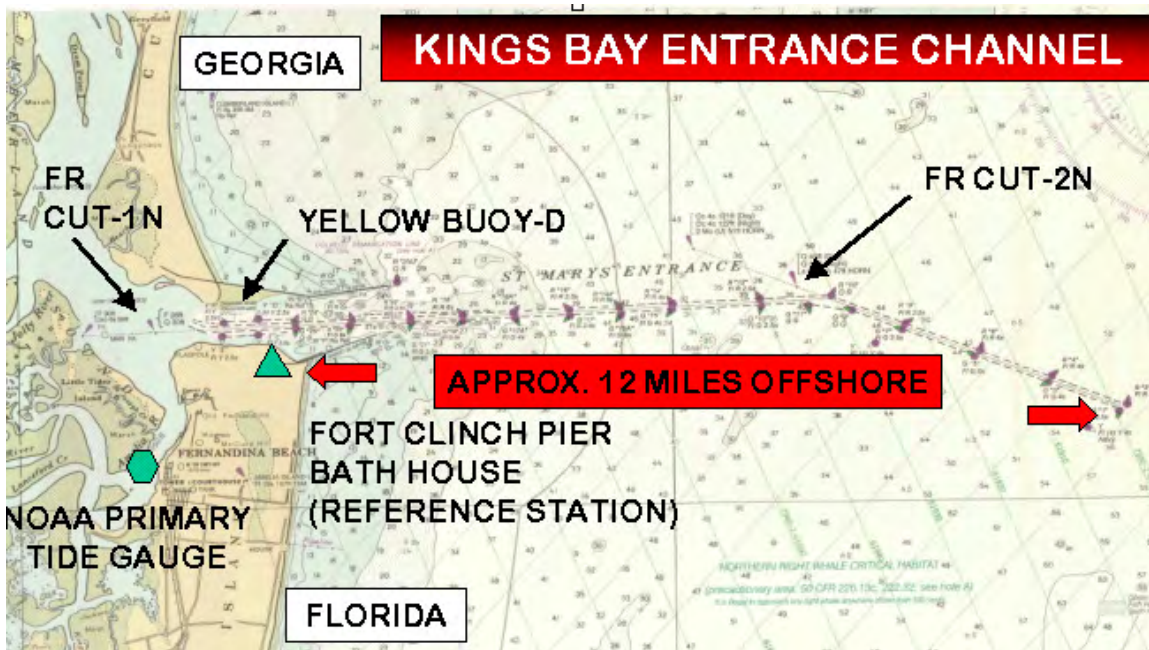

Figure H-1. Kings Bay (St. Mary's) Entrance Channel

a. In May 1997, the Jacksonville District contacted the U.S. Army Topographic Engineering Center (now Army Geospatial Center) to establish a tidal datum in the Saint Mary's Entrance Channel. The purpose was to update the entrance channel to reference the MLLW Datum. In addition, the Jacksonville District wanted to implement carrier phase RTK technology to allow hydrographic surveys to be performed without using tide gages. The Jacksonville District began the actual field work by performing wide area GPS static surveys during the Fall of 1997. Two acoustic tide gages were installed in Cut 1N between December

1997 and January 1998. The tidal datums at these two gage sites were computed by NOAA using four months of data. In order to mesh RTK water level measurements and conventional tide gage measurements, the Jacksonville District's Survey Vessel Florida performed carrier phase GPS tidal measurements between March and June 1998. The SV Florida anchored six times for 25-hour periods to provide intermediate datum points in the channel and correlate conventional tide gage methods to the GPS (RTK) tidal datum method. The vessel anchored twice at tide gage locations to check the change in ellipsoid heights received on-board from the GPS reference station (kinematic mode) against the ellipsoid heights at the tide gages (static mode) over a tide cycle. A software configuration in the hydrographic survey package developed by Coastal Oceanographics, Inc. (now HYPACK, Inc.) allows for the ellipsoid separation values to MLLW to be used to compute tide measurement from the waterline of the survey vessel.

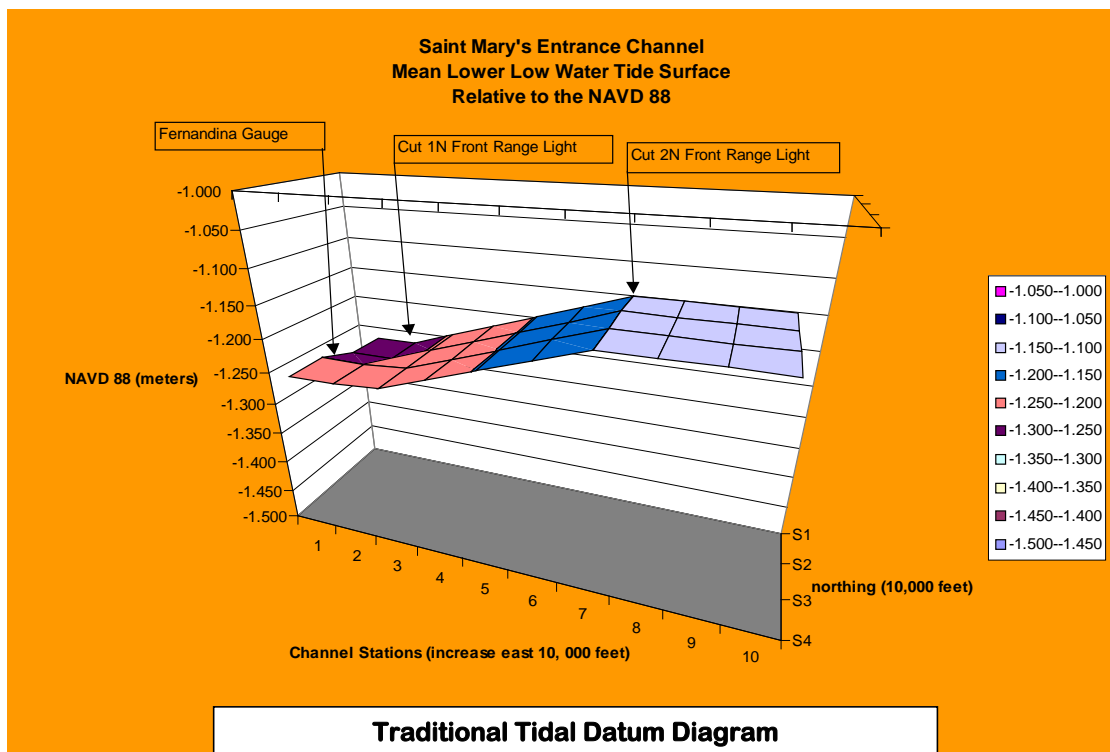

Figure H-2. Traditional tidal diagram for Kings Bay Entrance Channel

b. The entire project depended on the tidal measurements from the primary NOAA tide gage located in the Amelia River at Fernandina, Florida, two miles south of the Saint Mary's Entrance Channel. This gage was the primary tide gage used to measure the Mean Lower Low Water (MLLW) in the Saint Mary's Entrance Channel. A reference was needed to incorporate tidal datum measurements along the channel made relative to the Fernandina Gage. Two vertical references were used, the GPS ellipsoid and the North American Vertical Datum of 1988 (NAVD 88). The Jacksonville District accomplished the vertical references by performing the

GPS static survey over the entire project area. The GPS survey included two offshore front range lights used to guide submarines into port.

H-2.. Tidal Datum Diagram. A traditional tidal relationship for the Entrance Channel is shown in Figure H-2. The primary focus of modeling a project for RTK surveys is to develop the ellipsoidal tidal datum diagram shown in Figure H-3. The results shown on the tidal datum diagram provide the MLLW reference for the Saint Mary's Entrance Channel well within acceptable tolerances for dredging applications. This diagram uses the geodetic reference of NAVD 88. The mean sea level values on the diagram should theoretically be parallel to geodetic reference surface; however, the currents generated by the water moving through the inlet may help explain why the height values drop five centimeters (0.16 ft) from the ocean through the inlet to the confluence with the Amelia River. Ellipsoid height values can be plotted that map the relationship between the computed MLLW and the ellipsoid. These values and the GPS reference station used to measure the ellipsoid-MLLW separation allows kinematic GPS hydrographic surveys without tide gauges.

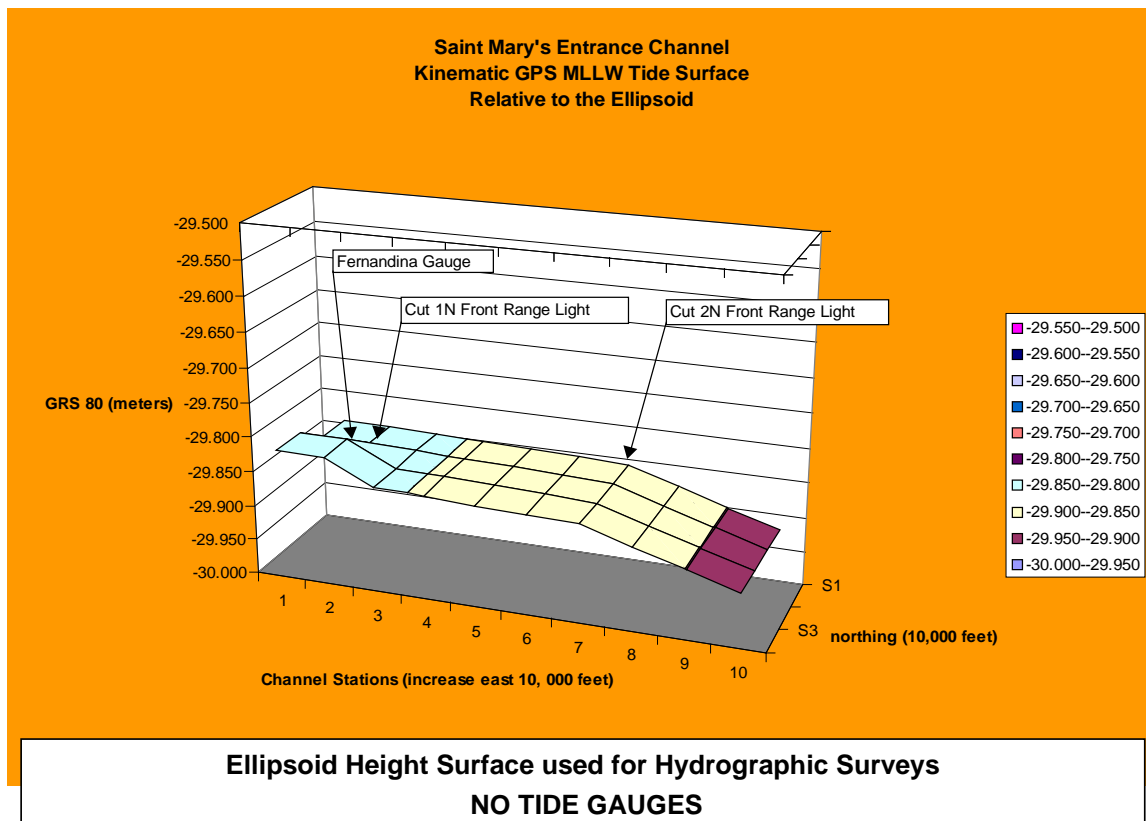

Figure H-3. Tidal model of Kings Bay Entrance Channel

H-3. GPS Reference Station. A permanent GPS reference base station (Figure H-4) was

established at Fort Clinch for future hydrographic surveys in the Saint Mary's Entrance Channel. An antenna height of (-) 20.015 m should be entered into the GPS receiver during GPS/RTK hydrographic surveys. If the RTK reference station antenna is moved, the value is invalid. If the antenna must be moved, the vertical difference between the bottom of the antenna and the reference benchmark must be remeasured-- and to confirm that the benchmark is $(20.015 + 3.645 = 23.660$ m below the ellipsoid. Run levels through the old antenna location and the new antenna location starting from the benchmark.

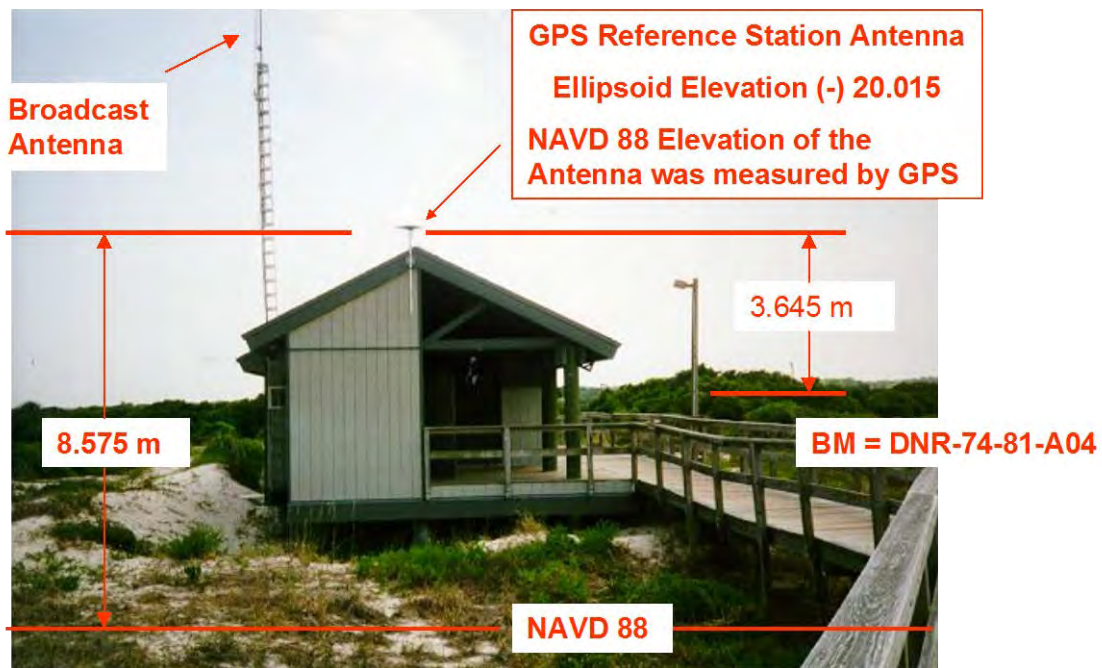

Figure H-4. RTK reference base station parameters.

H-4. Resultant RTK Elevation Accuracy. The target accuracy for real-time RTK elevations was + 0.25 feet. The resultant autonomous project accuracy is estimated to be + 0.22 feet (7 cm). The autonomous accuracy refers to the MLLW relative to the geodetic reference datum, NAVD 88. No local project modeling of the ellipsoid-geoid separation was attempted for the project. Geoid 96, a computer program written by the National Geodetic Survey, was used by entering the surveyed horizontal positions to compute the NAVD 88 /ellipsoid separations.

a. The relative accuracy of points in the channel is estimated to be + 0.13 feet (4 cm). This includes the accuracy of RTK between the boat and the reference station. The relative accuracy excludes the NAVD 88 monuments and the MLLW datum. A centimeter difference between adjusted GPS static vectors and uncertainty variations of two or three centimeters in RTK water levels observations using extremely short data series were the most difficult issues to resolve in modeling the project. The errors are insignificant for dredging. Of all the estimated vertical errors, only the GPS static survey provides a standard error of the actual measurements.

b. Hydrographic surveys for dredge payment volumes are associated with relative accuracies from the RTK reference station or relative accuracies from a tide gage. Use + 0.13 feet (4 cm) for RTK as set up for this particular channel or use + 0.2 feet (6 cm) at best by interpolating from the acoustic tide gages. Using only one tide gage, expect the accuracy to drop to at least + 0.4 feet (12 cm). Accuracy is a range not a number. This information can be used as part of the error budget associated with the accuracy of a group of soundings from a particular survey (e.g. a Mean Square Error).

H-5. Survey Vessel. The most important vertical measurement on the survey vessel is the GPS antenna phase zero measurement down to the water line of the vessel. In a static measurement condition, the measurement is as shown in Figure H-5. Underway the vessel speed through the water will change this measure. The nautical term for this phenomenon is called 'squat.' The vessel squat is not entered as a correction in the survey system in that the transducer depth is reduced by the same amount the antenna height is reduced.

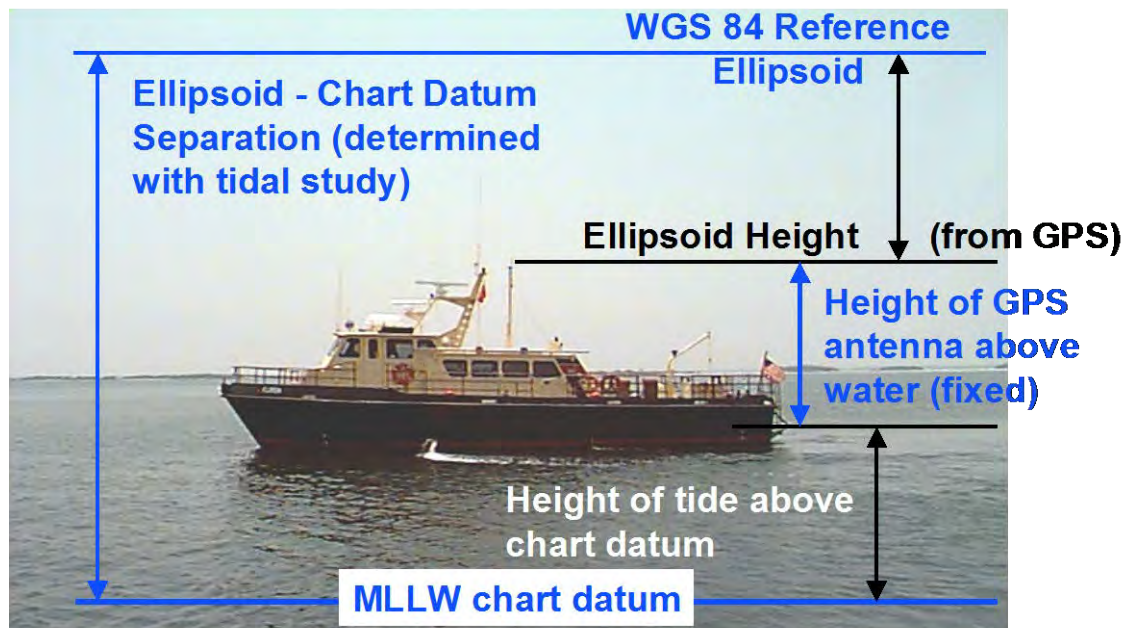

Figure H-5. RTK measurements on survey vessel

H-6. RTK Hydrographic Survey Procedures. Two survey methods are available in the Saint Mary's Entrance Channel. The traditional method will be discussed first. Two acoustic tide gages are currently running in Cut 1N on the front range light structures. The gage located on the east range light offshore has a Geostationary Operational Environmental Satellite (GOES) uplink. These data can be retrieved three hours later over the Internet as well as the Fernandina gage data. The data sets will produce a six minute time series. The inside gage is operated by the U.S. Army Corps of Engineers (USACE) and must be downloaded by USACE personnel. The data from these acoustic tide gages should be interpolated to the station numbers in the

channel where surveys are being conducted. Both gages should be used to eliminate actual time differences in the channel from average time differences between the gages. Using one gage and surveying four miles from it can result in errors to 0.4 feet (12 cm) on average. The gages are separated by 8.5 nautical miles. Using both gages, surveys conducted on different days should overlay on the outside portions of the cross-sections unless dredge material has settled on the outside areas. The second method precludes the use of a tide gage during the hydrographic survey. This tidal datum diagram was used to build a MLLW surface in the Coastal Oceanographics, Inc. program HYPACK. The HYPACK manual explains the procedure. The survey vessel must have equipment to receive specific GPS information from the USACE reference station. The Jacksonville District uses Trimble 4000 SSi RTK GPS equipment and a 25 watt (joules per second) radio transmitter that broadcasts carrier corrections every second on a frequency of 164.200 MHz. To implement this technology on a survey vessel, refer to the Survey Vessel Section. Levels must be performed on the survey vessel to obtain the vessel information.

H-7. Test Results. The first test of the RTK GPS Tides separation values (ellipsoid minus MLLW) was conducted on 29 June 1998. A matrix of the separation values was constructed in the Coastal Oceanographics hydrographic survey program called HYPACK. The SV Florida ran twenty cross-sections at 100 foot spacing in Cut 1N midway between the acoustic tide gages 8.5 miles apart. The personnel then traveled to the gages and downloaded the tides for that day. Both tide gages were interpolated to establish a tide curve time series midway between the acoustic tide gages. The interpolation method was tested and found to work in this particular channel. The survey vessel ran lines of channel cross-sections in the mid-channel area under normal survey conditions. The survey was then processed in two ways: the conventional method and the RTK method. The conventional method uses the horizontal GPS coordinates but not the vertical coordinate. The tide gage data was then used to reduce the raw soundings into reduced depths relative to the MLLW. The same survey was then processed by RTK GPS. The first depth and last depth of each line was selected for a comparison with the GPS depths differenced relative to the tide gage reduced depths.

APPENDIX I

Implementation of Inertial-Aided Post-Processed Kinematic GPS
Cape Canaveral, FL (Jacksonville District)

This Jacksonville District report describes the implementation of Applanix Post-Processed Kinematic (PPK) survey applications at a remote borrow site offshore of Cape Canaveral, FL. It also shows a comparison between PPK and RTK surveys near a reference gage.

I-1. Smart Base and Single Base Processing Using Applanix In-Fusion Technology.

Traditional GNSS positioning techniques are degraded by the effects of the atmosphere, satellite clock errors, and satellite ephemeris uncertainties. In order to reduce the effects these variables, shorter baselines are utilized to maintain correlation with the base station observables. The Applanix In-Fusion Technology combines the GNSS receiver's pseudo range and phase observables with the Inertial Measurement Unit (IMU) data. This "fusion" of GNSS and IMU observables results in a more accurate analysis of positional and inertial data. The "synergy" resulting from this integration allows extended baseline lengths while still achieving higher levels of accuracy than with traditional GNSS positioning techniques. The post-processing capabilities resulting from the storage of the real-time GNSS and inertia observables also allows users to perform surveying activities without relying on radio corrections from a base station. This factor has always been a hurdle for performing surveys with high accuracy requirements outside radio range from the base station.

I-2. Inertial-Aided Post-Processed Kinematic (IAPPK) Tides. Hydrographic surveying procedures incorporate a variety of positioning techniques while collecting bathymetric data. Code phase DGPS and RTK are currently the most popular methods of determining vessel position while collecting bathymetry. While both methods have proven to be effective and somewhat reliable, their accuracy deteriorates when working outside their intended range parameters. DGPS positioning techniques provide meter- to sub-meter horizontal positioning accuracy to the survey vessel. The vertical accuracy of DGPS is not suitable for tidal reductions and thus requires a tide gauge augmented with logging capabilities or a radio transmitter to relay water level information to the surveyor. This method is somewhat limited in range and only gives accurate tidal reductions in close proximity to the gauge itself. It is incapable of accounting for variations in water surface profiles arising from tidal phase lags and extrapolated tidal readings. In regions with large tidal ranges such as those in the northeast, these effects can become quite large. In order to overcome the effects of these variations in water surface profiles, other methods must be utilized. Some surveyors set multiple gauges within their project reaches in an attempt to minimize the effects of water surface variations. An easier and more accurate solution incorporates the use of RTK (real-time kinematic) positioning.

a. Real-time kinematic tides have become the preferred method of collecting bathymetry data with high accuracy requirements. This technique achieves centimeter level accuracy both horizontally and vertically. It has the ability to accurately determine tides without the errors

associated with localized tide gauge readings. This method does, however, have its weaknesses. RTK tides depend on corrections from a base station. The base station collects carrier phase data and transmits corrections to the survey vessel. This technique assumes similar atmospheric conditions at the vessels location. This is usually accurate over short baselines (< 10 km but is not true over longer distances. Generally, the RTK corrections are incapable of reaching their intended target at ranges much greater than this anyway. Post-processing methods must then be incorporated to correct the real-time observations to an acceptable accuracy level.

b. Post-processing opens the door to a new realm of accuracy capabilities. Real-time positioning observables can be analyzed, filtered, and smoothed in an attempt to achieve higher accuracies at greater distances. When performing a survey in real-time, surveyors rely not only on their GNSS system for positioning, but also the aid of inertial measurement units. Post-processing provides surveyors the opportunity to reproduce real-time events while incorporating other sensor data such as inertial measurements into the solution. Limited satellite availability, radio communication, and extended baselines have typically hindered the ability to achieve high accuracy surveys under some circumstances. This hurdle has been overcome with the advent of IAPPK or Inertial-Aided Post-Processed Kinematic positioning. GPS outages and other anomalies incorporated within the real-time data collection are smoothed therefore producing the optimal solution. This is done by a forward, backward, and combined filtering process using the position and inertia data received from the GNSS receiver and the IMU. This is where the Applanix In-Fusion Technology got its name. The POSPAC MMS software “fuses” or integrates the GNSS and IMU data and creates a SBET or Smoothed Best Estimate of Trajectory. This software will be used to analyze several data sets using multiple processing techniques to demonstrate IAPPK and its applications.

I-3. Hydrographic Applications in IAPPK. There are a multitude of applications in which IAPPK can and should be utilized. The techniques mentioned previously outline the different methods used to collect bathymetric data as well as the errors associated with each. To demonstrate the procedure of post-processing inertially-aided kinematic positions, several scenarios are illustrated below. The following sections and screen captures describe the procedures for processing POSPAC data.

a. Offshore (10-70 km) Applications. When performing surveys within the range of 10-70 km from the shoreline, maintaining radio communications with the base station can be somewhat of a problem if not impossible. Tide gauge readings do not meet accuracy requirements at this range due to tidal phase lags. This leaves the surveyor with limited options to collect accurate bathymetry. The data must be post-processed in order to achieve the desired level of accuracy. The following illustration outlines the procedure of using POSPAC MMS Single Base In-Fusion Technology and HYPACK to process bathymetry of a borrow site located approximately 10 miles offshore.

b. Cape Canaveral Borrow Site Survey. The depiction in Figure I-1 illustrates a project in which the RTK base location is incapable of transmitting corrections to the survey site due to

range limitations. There is an active NOAA tide station located approximately 12 miles west of the survey site. This site was determined to be too far from the survey site due to phase lag issues resulting in inaccurate tidal extrapolations. IAPPK tides processed using POSPAC MMS and HYPACK were chosen to perform the survey.



Figure I-1. Cape Canaveral Borrow Area.

c. Setting up the Hardware. Prior to surveying, setup the real-time data strings to be logged. The POS MV has an auto select option that simplifies this process, as illustrated in the following screen captures.

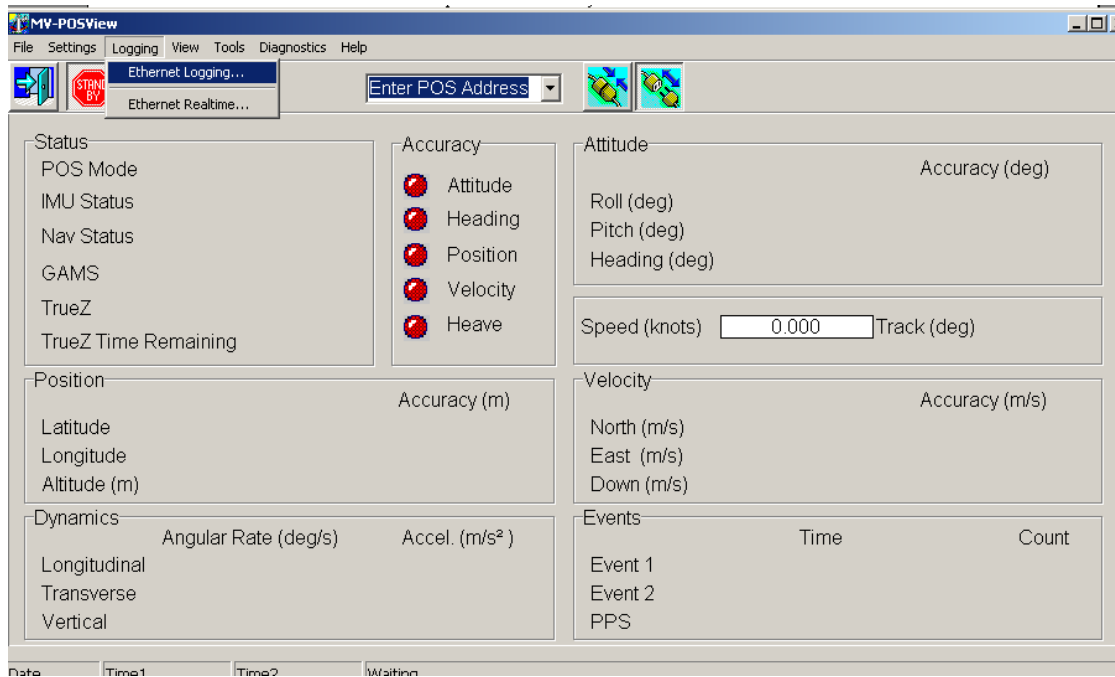

Figure I-2. MV-POSView, the startup screen on the GUI.

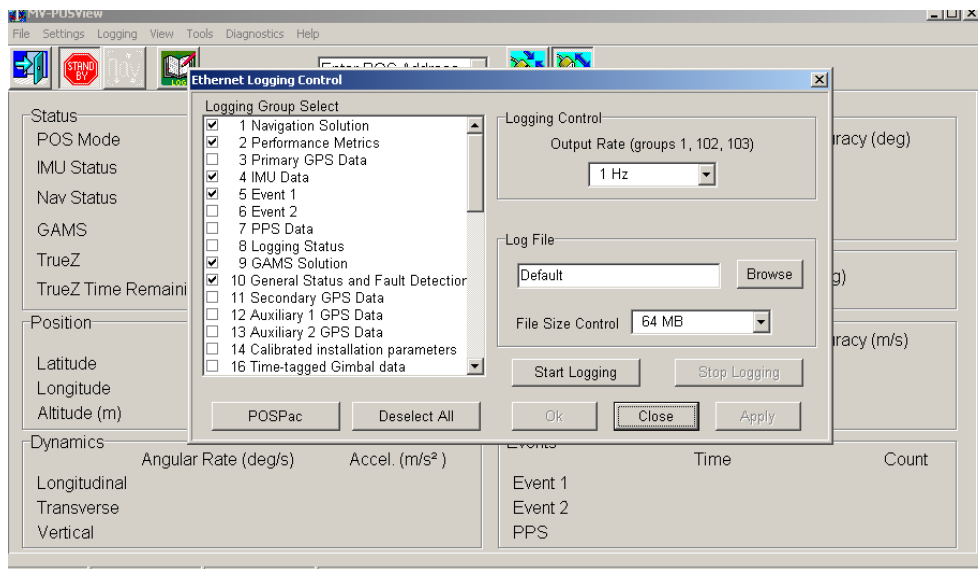

Figure I-3. Ethernet logging options window inside MV-POSView.

d. It is recommended to begin logging the POSPAC file for at least 15 minutes prior to proceeding with the data collection.

e. HYPACK Hardware Setup. Next, there are certain settings that must be addressed within the HYPACK Hardware program:

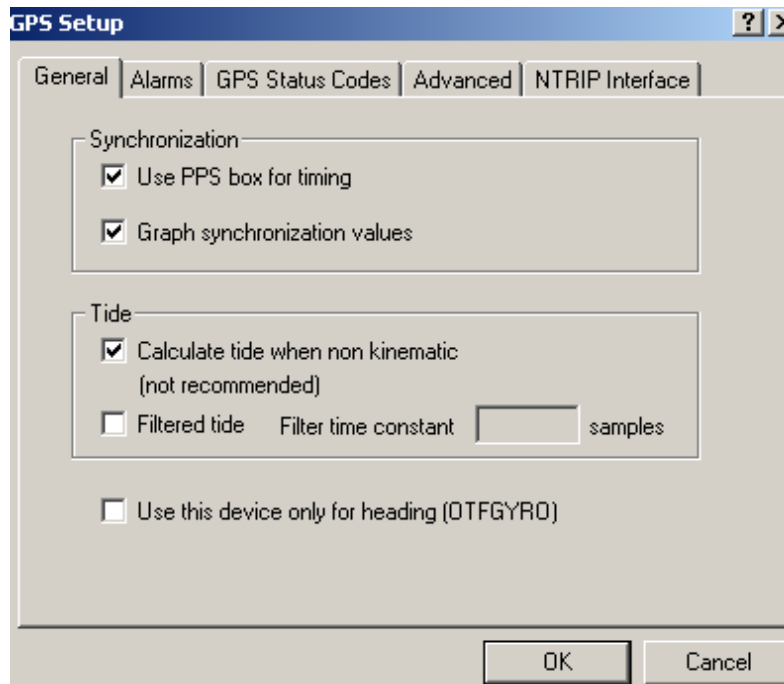

Figure I-4. HYPACK Setup window for the GPS.dll driver.

f. HYPACK must be set up to calculate tides when non-kinematic. This tells the software to look for a tidal correction from the GPS driver when proceeding into the processing mode following the data collection.

g. Processing the data. Initiate POSPAC MMS and begin a default project. Save the project with the appropriate project name and import the data files. The first step is to import the POS file (.000) logged by the Applanix. This file includes all GNSS and IMU data collected by the vessel during the real-time data collection. Another potential use of POSPAC MMS is any lever arm offsets input into POS VIEW prior to data collection can be adjusted in the Settings of the POS file once loaded. The new lever arm values will be applied in post processing. Various POSPAC MMS processing screen captures are shown below.

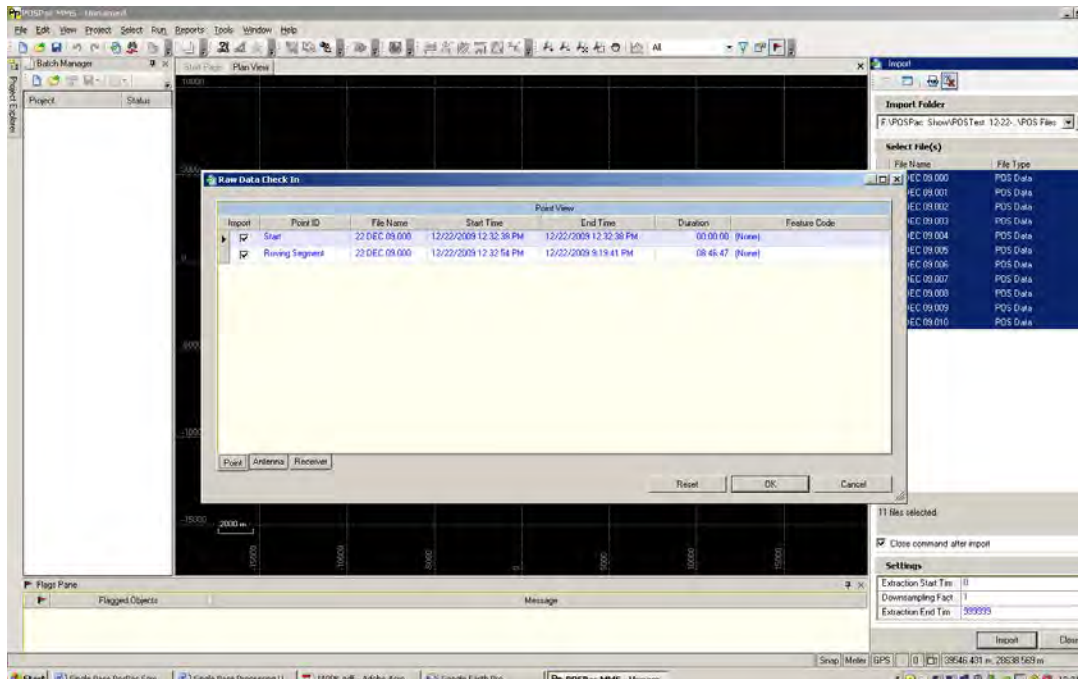

Figure I-5. Options window for importing Logged GPS and IMU data into POSView MMS.

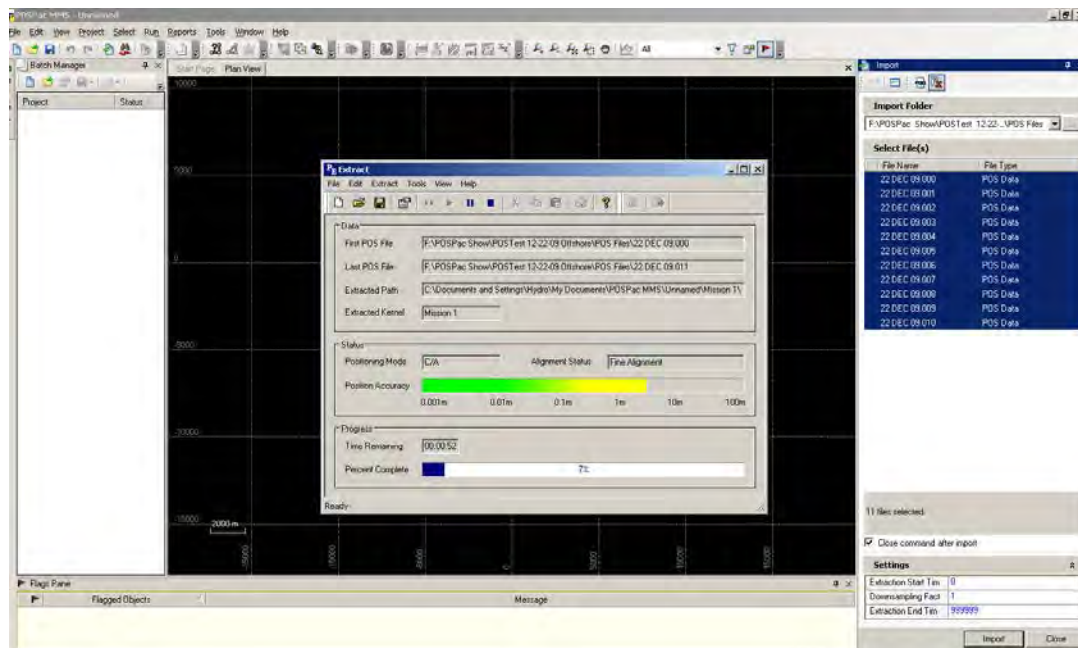

Figure I-6. Progress bar of logged GPS and IMU while being imported into POSView MMS.

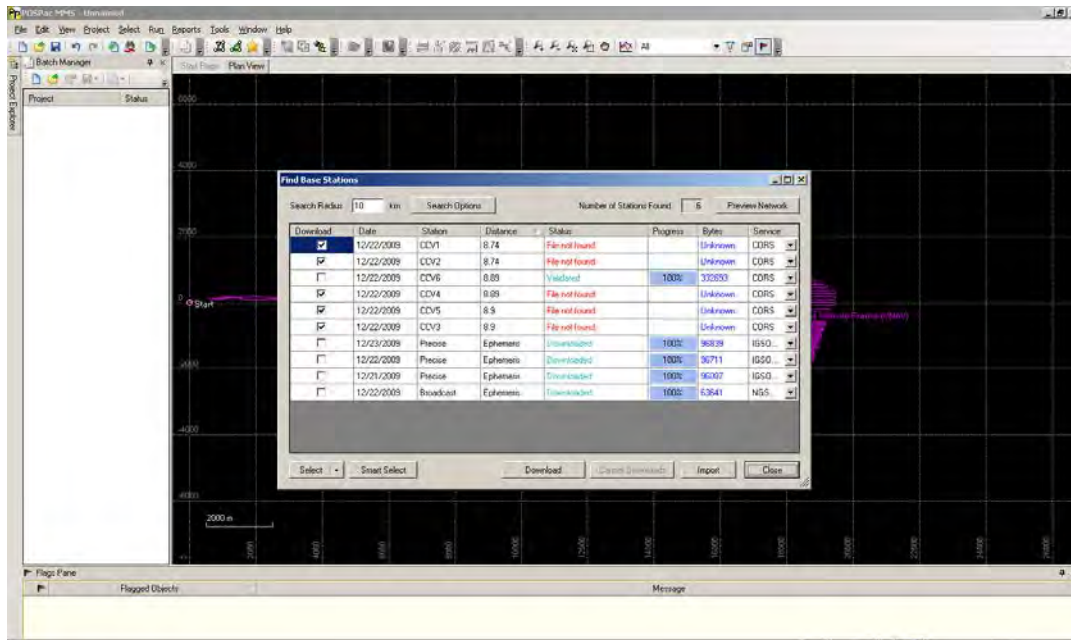

Figure I-7. Search results of available CORS data from time of survey.

h. POSPAC MMS processing. There are several ways to proceed at this point. The POSPAC MMS software allows users to choose single base or Smartbase to process the POS file. This example will utilize the single base method. First, download the ephemeris and Rinex files from the selected control station. If a local single base station is used, the ephemeris data does not need to be downloaded, which would allow the user to post process the data without an internet connection. Jacksonville District has processed multiple data sets using the single base station with and without the ephemeris and has seen no difference. This can be a control station set up by the surveyor or one of the many CORS stations near the project. The following example will demonstrate how to download the raw GPS data from a CORS station. It should be noted that there are many times that a certain CORS station does not have data available, which would force one to use a CORS station much further away which leads to less accurate results. Jacksonville District has found it best to set up a local Base station to log to and have the CORS Stations as a backup.

i. Click on the “Find Base Stations” icon and select a search radius. Start out small to determine what is available within the project vicinity. An internet connection is required to proceed with this method. The software automatically links to the appropriate websites to retrieve the raw data files needed to process the data. Optionally, download all the available data files in order to see the locations of the available control sites. The available stations can be viewed by the Preview Network button on top of the window instead of downloading them all. Once the appropriate files are downloaded, select the files to import. Import the Rinex files as

EM 1110-2-1003
30 Nov 13

well as the ephemeris files for the appropriate time frame. POSPAC MMS will populate the appropriate ephemeris files.

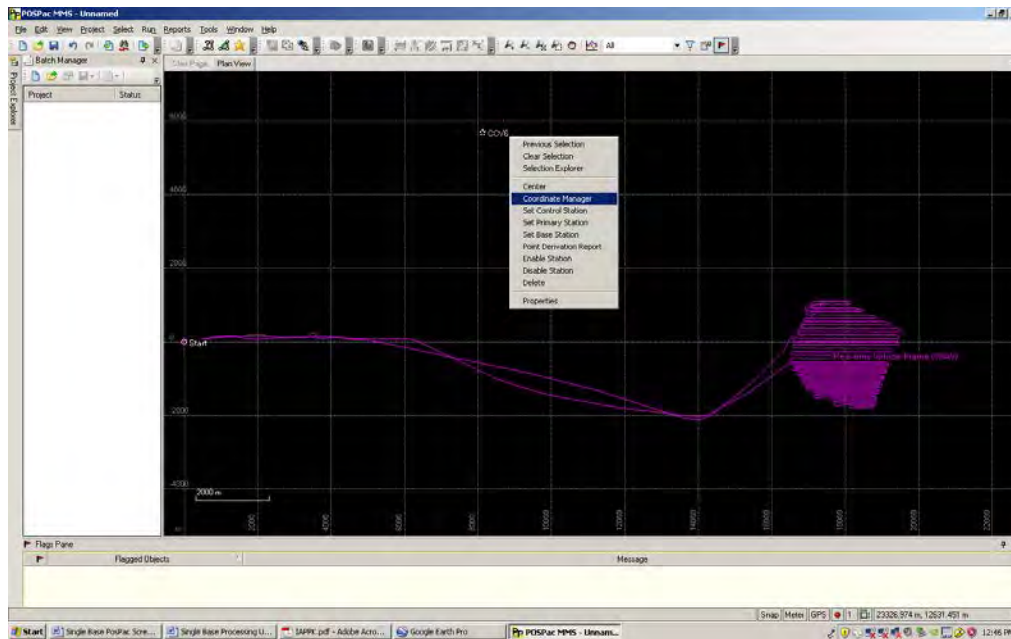

Figure I-8. Right clicking on the control point will produce the drop down menu for the selected point.

j. The control station is now populated within the project. Now evaluate the properties of the control station. This should always be done. At times the coordinates from a CORS station have been found up to three feet off. Input the coordinates of the station or change other properties such as antenna type and set-up height.

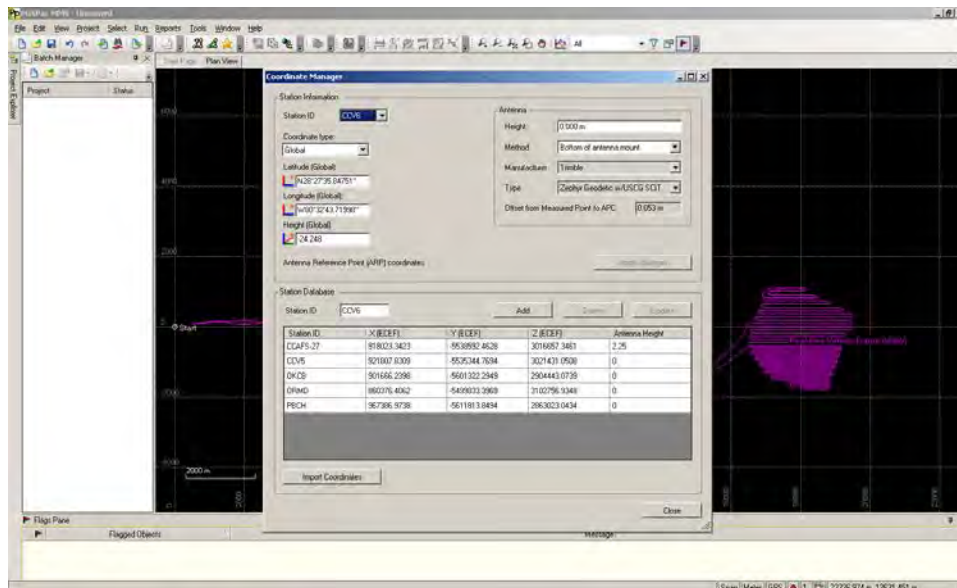

Figure I-9. POSView MMS Coordinate Manager options window.

- k. Set the selected point as a base station.

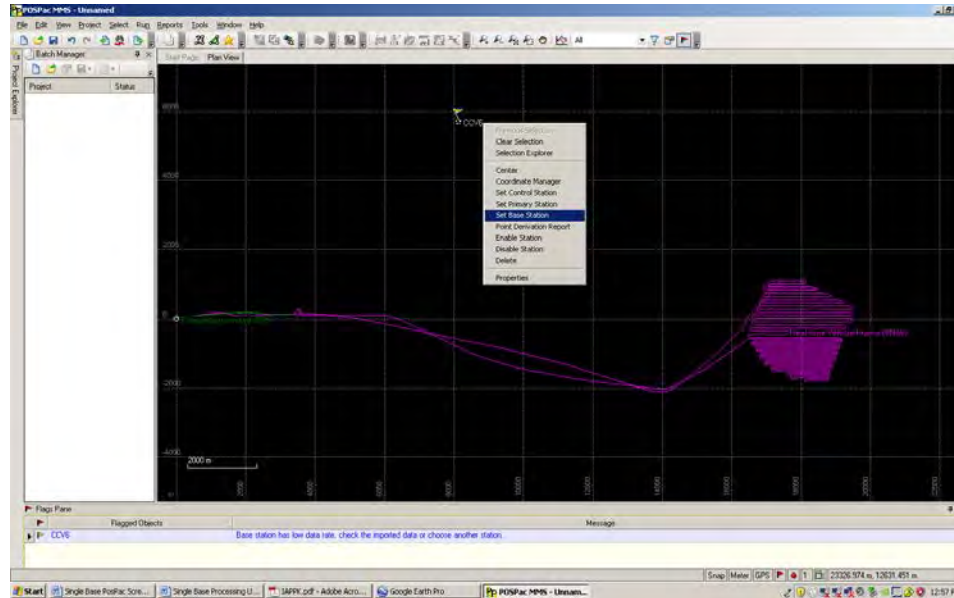

Figure I-10. Setting the selected control point as the base station for post-processing.

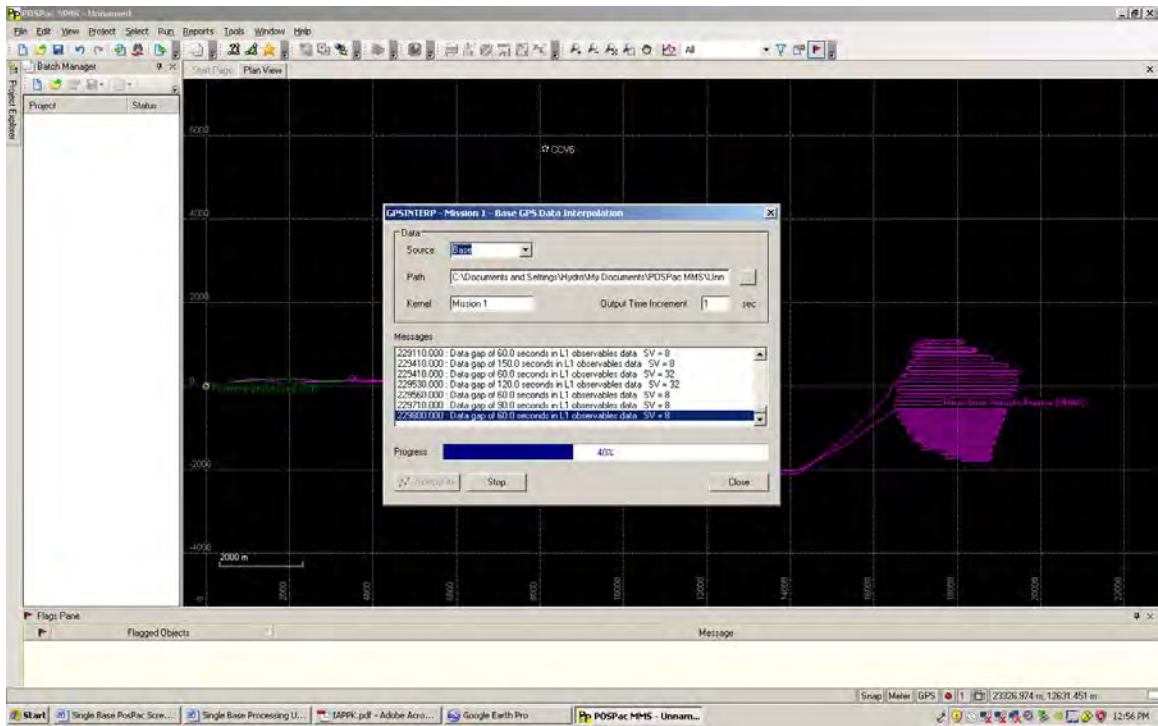

Figure I-11. Progress window of POSView MMS setting the selected base station.

1. Once these parameters are set, proceed to the GNSS-Inertial Processor.

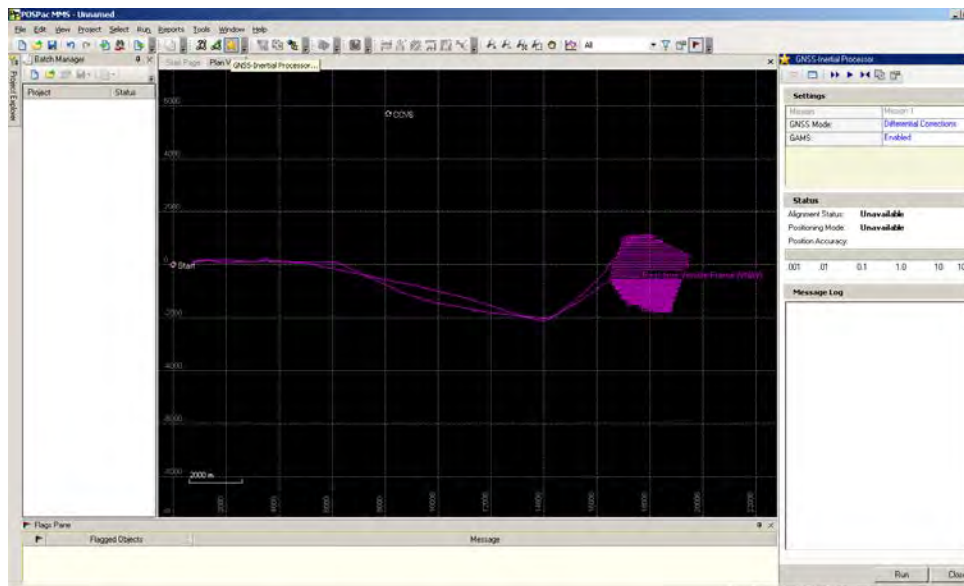

Figure I-12. Toolbar on right side screen is options window for GNSS Inertial Processor.

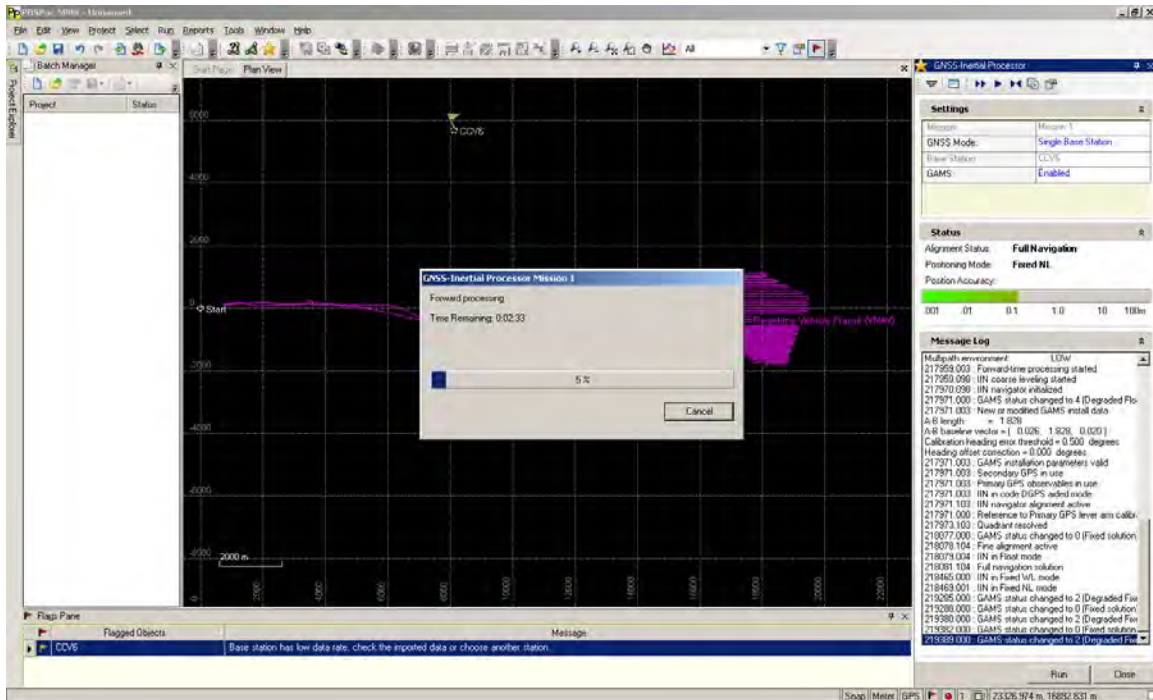

Figure I-13. Progress bar of GNSS Inertial Processor- note bar on right shows adjusted solution status.

m. The software is now performing the forward, backward, and combined integration and filtering of the GNSS and inertial data. The result will be a Smoothed Best Estimate of Trajectory (SBET) that will be used by HYPACK to reposition the sounding data. Next, analyze the results of the processing for quality control. The software creates a multitude of reports describing both real-time and post-processed data events.

EM 1110-2-1003
30 Nov 13

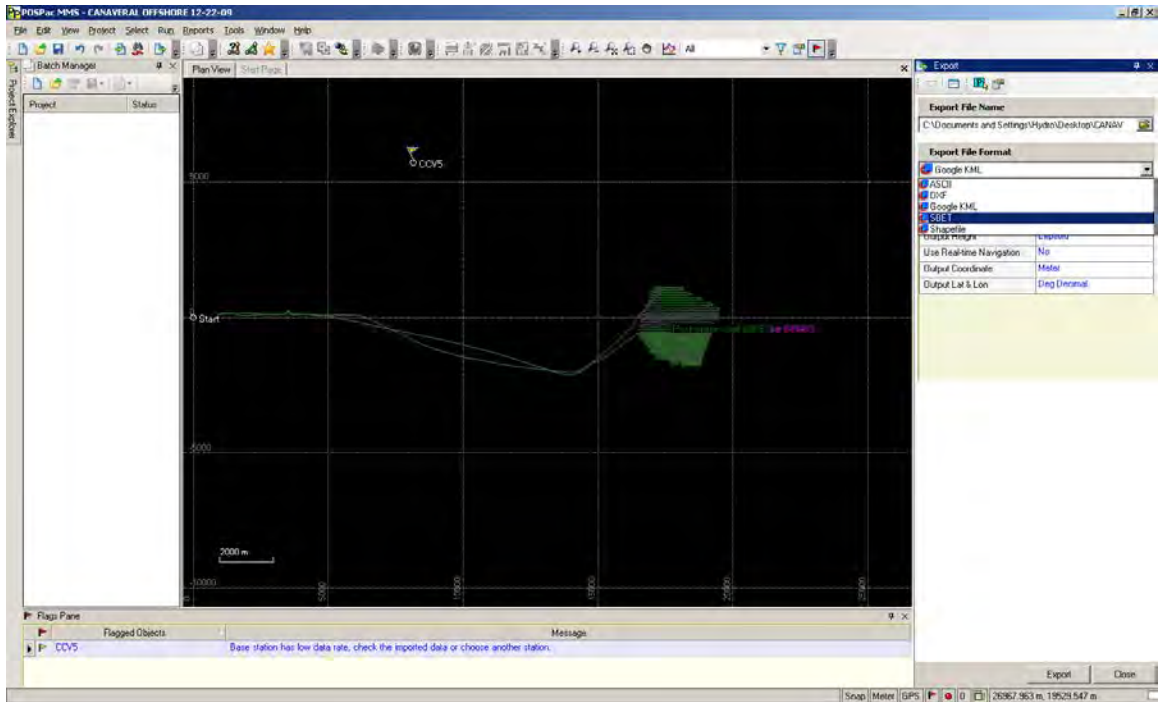

Figure I-14. The export toolbar on the right of the screen showing all the available export formats.

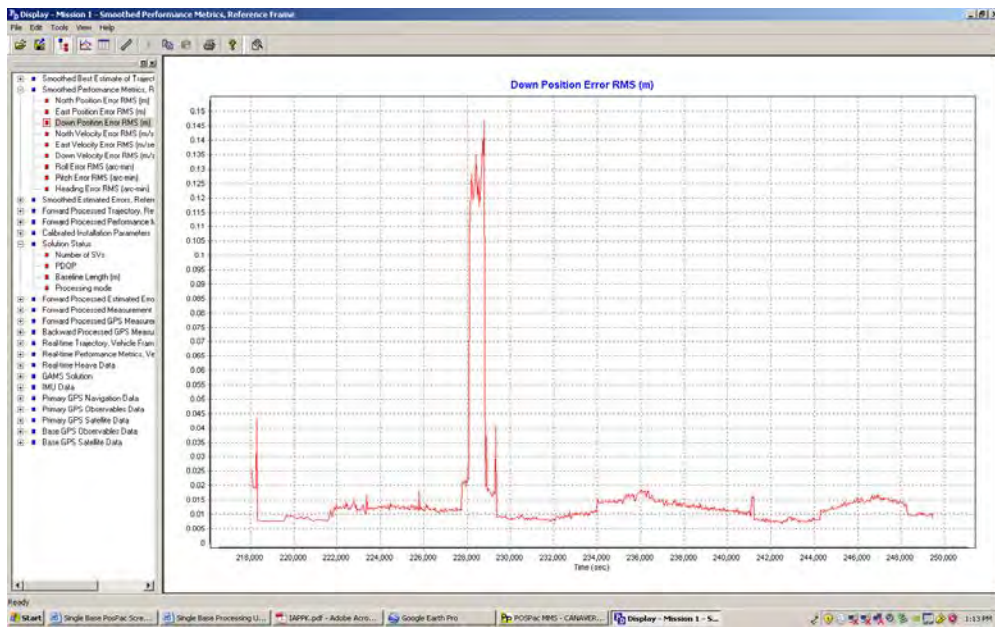

Figure I-15. Down position error RMS of the post processed solution.

n. The depiction above represents an example of one of the solution reports created by the software. This particular graph indicates the RMS of the SBET's altitude parameter. After reviewing the data and exporting the SBET file, begin processing the sounding data in HYPACK.

o. Open HYPACK'S Single Beam Editor and proceed to the read parameters. The following boxes must be checked. Make sure the project geodesy is properly configured. If there are any Orthometric height corrections, KTD files, etc., HYPACK will apply these corrections to the data in the processing phase. The KTD file will only be applied if the file is enabled in the HYPACK shell before the editor is opened. Also note that the HYPACK hardware in the processing job must match the hardware settings from the HYPACK job that was used for data collection. If this is not done the file will appear to be applied but the Tide values will "0" through all files.

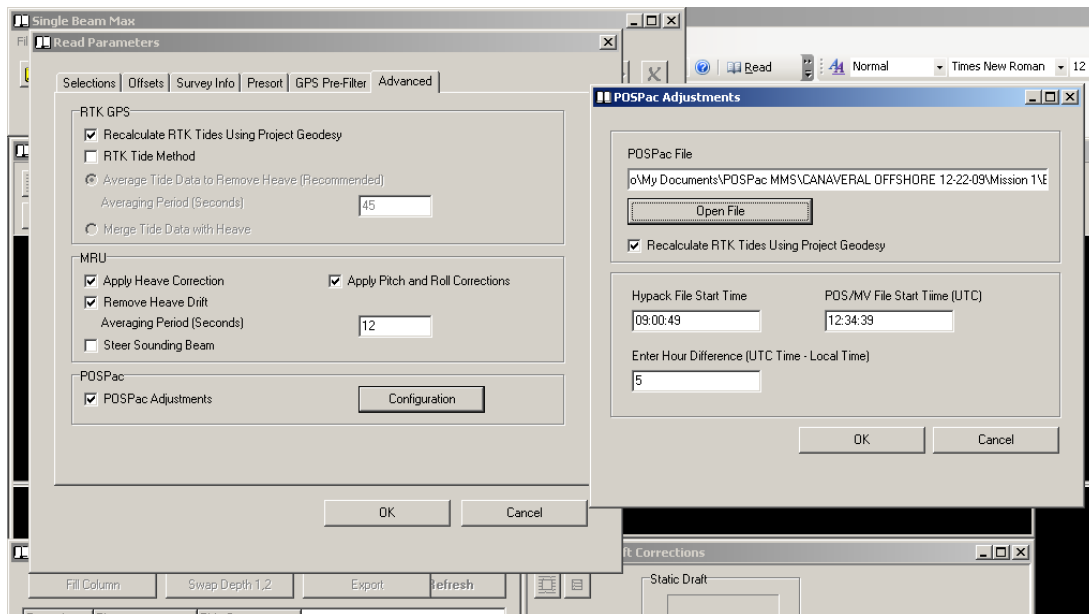

Figure I-16. Read Parameter window in HYPACK, shown importing a SBET file exported from POSView MMS.

p. Load the SBET file produced by the POSPAC MMS software. Select the Configuration icon within POSPAC Adjustments and load the file. Be sure to enter the difference between UTC Time and Local Time. Account for daylight savings time if applicable. Click OK and stand by while HYPACK loads the file and applies the corrections. This process will take several minutes and depends on the size of the SBET file.

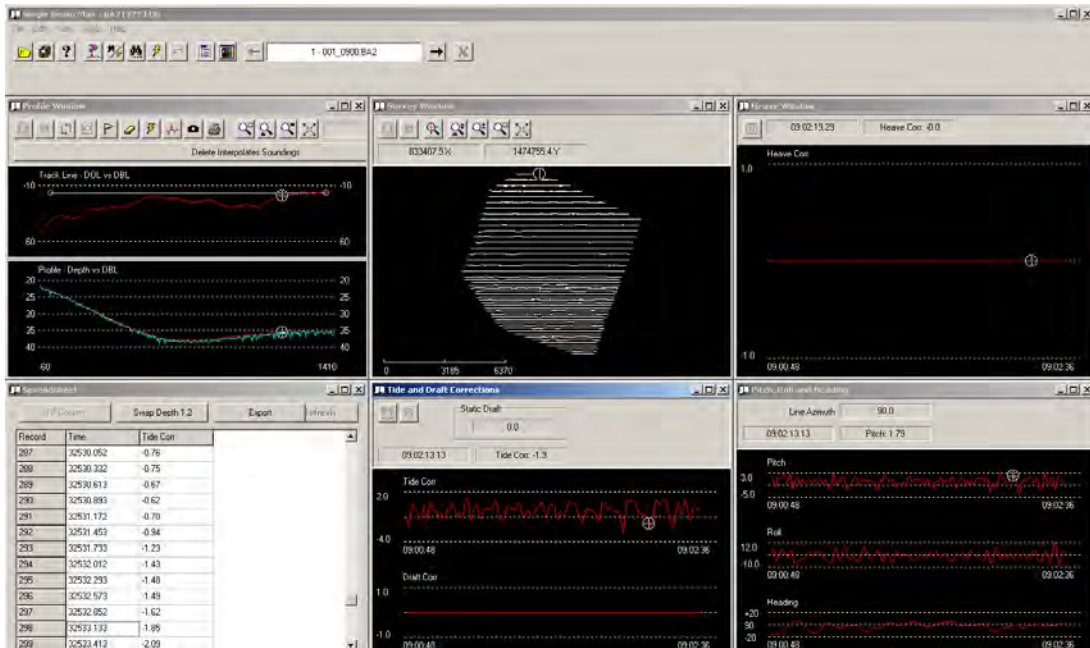

Figure I-17. Typical windows from HYPACK Single Beam Editor (SBMAX.)

q. Once the file is loaded, proceed with processing the sounding data as with any other setup.

I-4. Analysis.



Figure I-18. An exported Google KML file from POSView MMS.

a. The SBET file is shown here as a KML file within Google Earth. The real-time data was collected using DGPS while logging a POSPAC file within the Applanix. The data was processed using the extrapolated tidal readings from the NOAA gauge as well as with the SBET

file created by the POSPAC MMS software. A sounding matrix depicting the two methods is shown below.

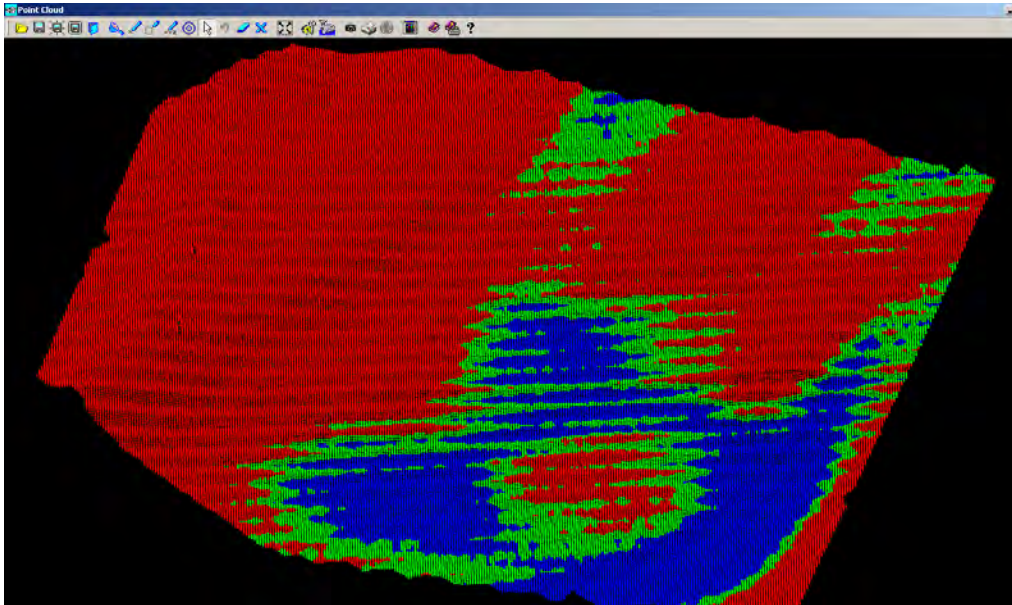

Figure I-19. Sounding Matrix showing phase lag errors caused by tides.

b. The bathymetry depicted above was collected with single beam at a 150' line interval. The data was then tinned and exported on a 25-foot grid. The data was collected on two separate days. Each day, every other line was surveyed in order to amplify any phase lag errors. Note the stair stepping of the data set. This data set was processed using observed tidal readings at the NOAA tide gauge. This gauge is approximately 12 miles from the survey site. The tidal observations at this gauge site have introduced phase lag errors into the data set.

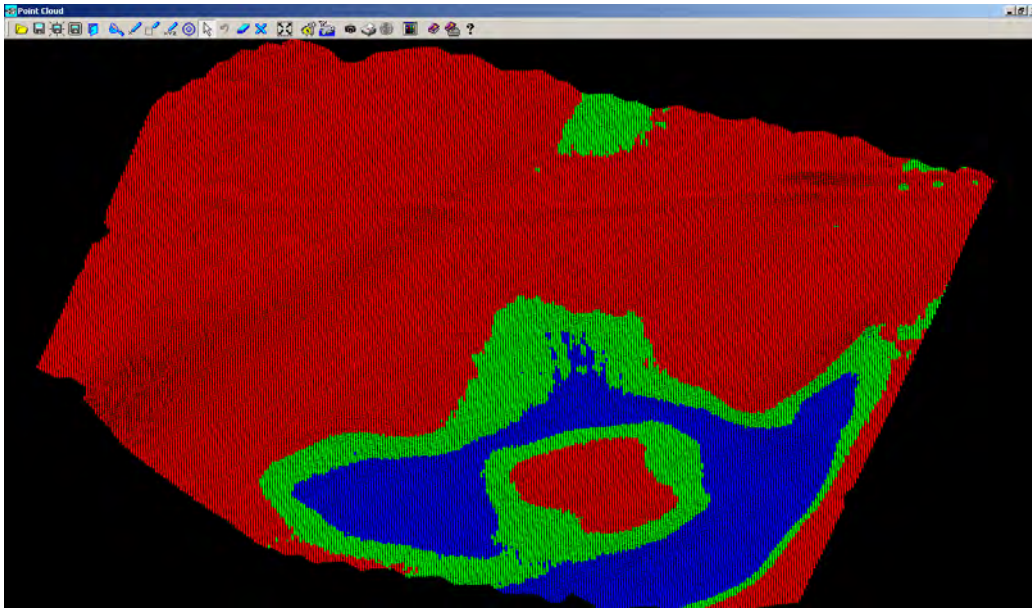

Figure I-20. Same data set, but with POSView MMS SBET file applied.

c. The bathymetry depicted above is the exact same data set processed using the Single Base Applanix In-Fusion Technology. Note the data has been smoothed and corrected for phase lag errors.

I-5. Inshore Applications. When performing surveys within a network of multiple CORS stations, a PPVRS (Post-Processed Virtual Reference Network) with the Applanix Smartbase solution is the best course of action. The POSPAC MMS software has the capability of creating a virtual reference network that completely envelops the project. This process reduces or eliminates errors associated with atmospheric biases.

a. Setting up the hardware. This method utilizes the same hardware set-up as the single base solution.

b. Processing the data. Most steps in the data processing are identical to the single base solution. The main difference is rather than downloading raw observables for a single base, we will download multiple base files in an attempt to create a network that encompasses our navigation data. Once the station data is downloaded for each site, the POSPAC MMS software will perform a network adjustment and select a single base to minimally constrain the network dependent upon the general location of the navigation data. This process creates what is known as a VRS (virtual reference station). In effect, the VRS creates a zero baseline length solution while working within the limits of the network. The figures below depict the process of creating this network.

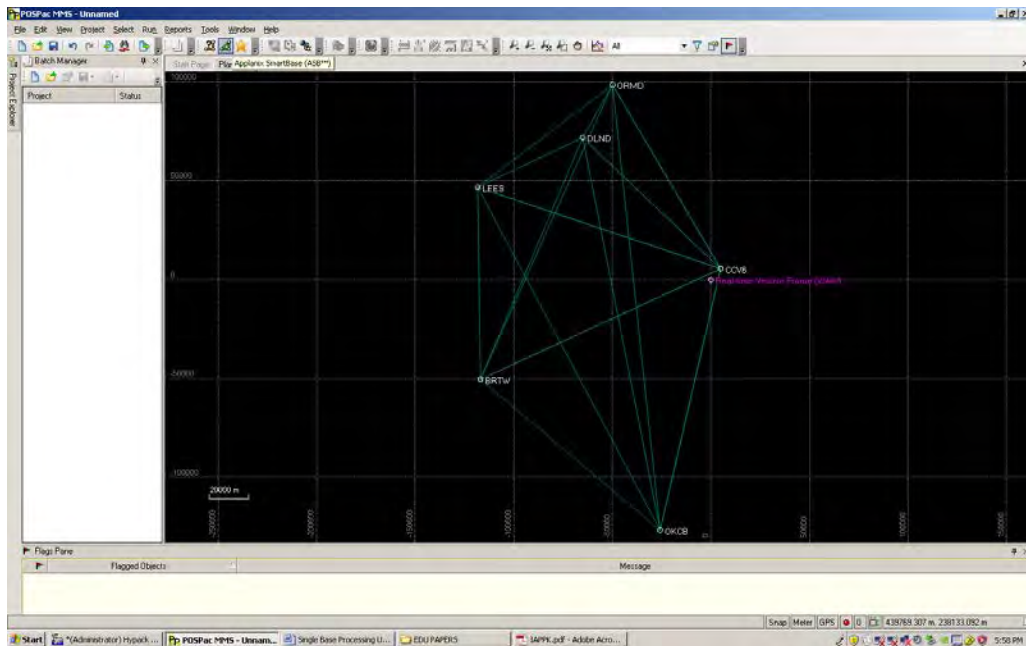

Figure I-21. GPS network created from CORS available during time of survey.

c. Download available GNSS data within the vicinity of the project. This is done by selecting a search radius around the navigation data and allowing the software to populate available sites. Once the sites are downloaded, preview the network and select the sites to utilize. The next step is to allow the POSView MMS software to perform the network adjustment and select a Smart Base. This is done by simply clicking the Applanix SmartBase icon.

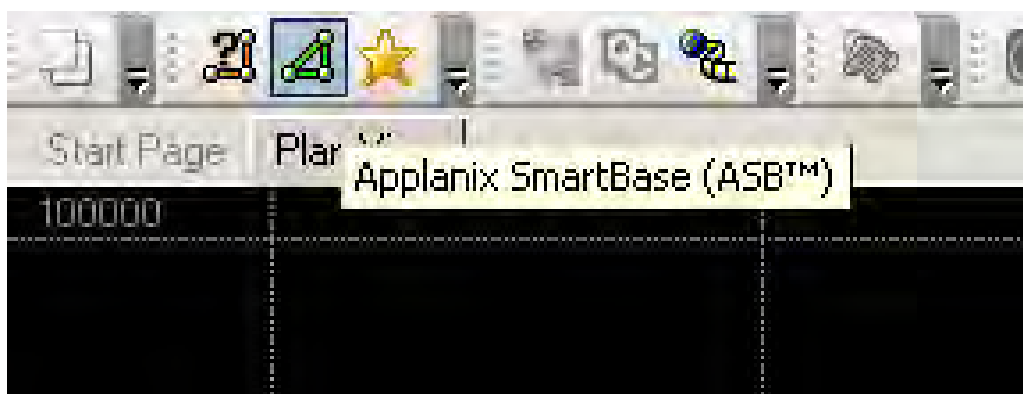

Figure I-22. Applanix SmartBase Icon located on POSView MMS main toolbar.

d. Proceed with the GNSS-Inertial processing and export the SBET file for HYPACK. This process is performed in the same manner as previously discussed with the Single Base solution.



Figure I-23. Google KML file created by POSView MMS.

e. Analysis. The SBET file shown above is a KML file within Google Earth for Port Canaveral. The real-time data collection was performed twice. Once in stand-alone mode while logging a POSPAC file within the Applanix, and again utilizing RTK positioning from a base station approximately located one mile east. The data was processed using the RTK positioning as well as with the SBET file created by the POSPAC MMS software. This was done to demonstrate the post-processing ability of the POSPAC MMS software. There is essentially no notable difference between the two data sets. The cross section comparisons are shown below.

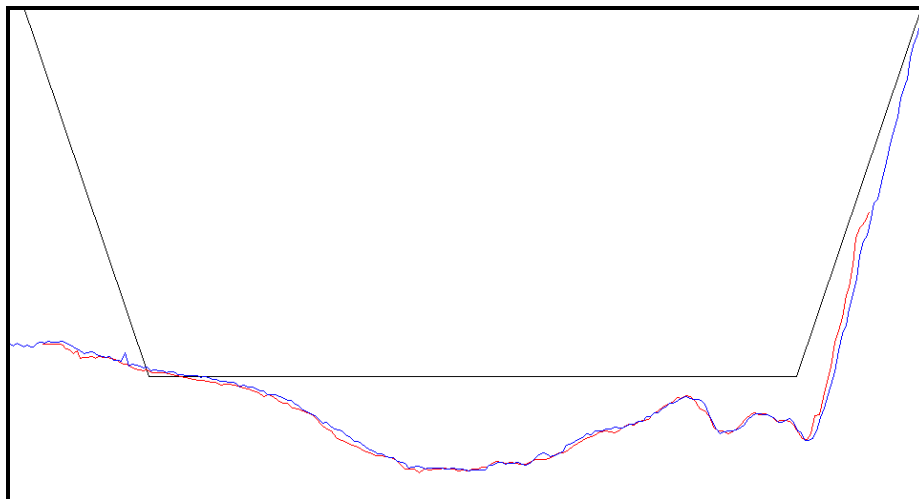

Red = RTK FIXED BLUE = PPVRS

Figure I-24. Cross section comparison of data using PPK vs. data using Real-time RTK

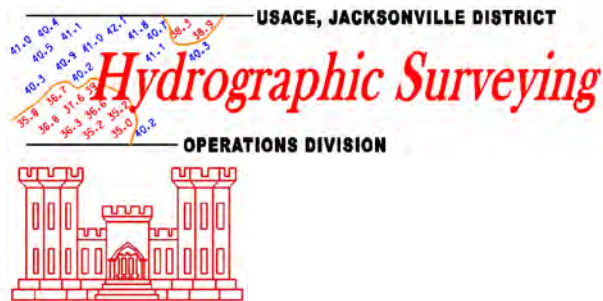

APPENDIX J

Field Survey Report: Project Condition Survey Tampa Harbor, Egmont Bar Channel and Mullet Key Channel (Jacksonville District)

J-1. Following is a typical field report for a project condition survey. Information from such reports is incorporated on the final drawing files and included with metadata archives. Portions of this 2011 report have been edited to conform to the revised guidance in Chapter 8 of this manual.

SURVEYOR'S REPORT Hydrographic Survey Pinellas County, FL Survey Number 11-031

Project: Tampa Harbor, Egmont Bar Channel and Mullet Key Channel 43 & 45-Foot Project Examination and P & S Survey, FY11

Location: Tampa Harbor, Hillsborough County, Florida

Date: Field data was acquired from 19 Jan thru 6 Jun, 2011

Personnel: SB-Jacksonville System Operator: Gary Campbell; Boat Captain: William Turner.

Datum: The horizontal coordinates are referenced to the State Plane Coordinate System, Florida West, North American Datum of 1983 (NAD 83). Elevations are referenced to MLLW from the latest tidal epoch available from NOAA. The MLLW-NAVD88 relationship was modeled using NOAA's V-Datum and incorporated into the HYPACK Kinematic Tidal Datum Model for Tampa Harbor. The KTD file SPC-FL-West-2010-12-07.ktd was utilized for this survey.

Instruments: The following instruments were used for data collection:

Survey Vessel: SB-Jacksonville

EM 1110-2-1003
30 Nov 13



Data Collection Software: HYPACK version 2010
Sounders: R2 SONIC 2024 Multibeam System
[Ross Smart Sounder 835 -- 28 and 200 kHz-not used]
Positioning: Applanix PosMV 320
Trimble 5700 Base Receiver/ Trimble Trimmark3 Radio
IMU: Applanix PosMV 320

Field Procedures: A multibeam condition survey was conducted on the subject project cuts. Survey lines were run parallel with the channel at a line spacing affording 100% bottom ensonification. Side slope coverage was approximately 100 ft outward from the channel toes. This survey was controlled utilizing Real-Time Kinematic (RTK) GPS for horizontal positioning and water surface elevation determination. The base receiver was set on survey monuments "TH-89 USE" (AG0988) for all cuts. A tide staff was established from NOAA monument "6367 C" (AG7401) and read to verify RTK tide elevations. The staff set at this location depicts tide data with respect to MLLW relative to the latest tidal epoch. Tide staff v. RTK surface elevation checks were performed before and after daily survey operations. These calibrations were recorded in Tampa Harbor field survey book TH-06. Monument data can be reviewed in *APPENDIX A*.

Special Notes:

Quality Assurance: The previous surveys performed were longitudinal line surveys; an accurate comparison between the current cross-section survey and previous surveys cannot be made. Spot checks between previous and current data sets were made and found to be very close (<0.2'). A QA Performance Test was conducted. Biases between the reference and check surveys were +0.05 ft and the 95% standard deviation was ± 0.5 ft within the ± 45 degree beam width.

Draft & Sound Velocity Calibration: Draft & Sound velocity corrections were obtained via bar check and Odom Digibar velocity probe performed within project area. Speed of sound checks were performed daily in the project area. Complete records of bar checks and velocity calibrations are logged in Tampa Harbor field survey book TH-06.

Data Processing: The survey data was processed aboard the survey vessel upon completion of the survey. Since this entire survey was performed using Multibeam systems, quality assurance was performed during HYSWEEP processing by visually examining differences in overlapping lines as well as overlapping segments. No anomalies were found.

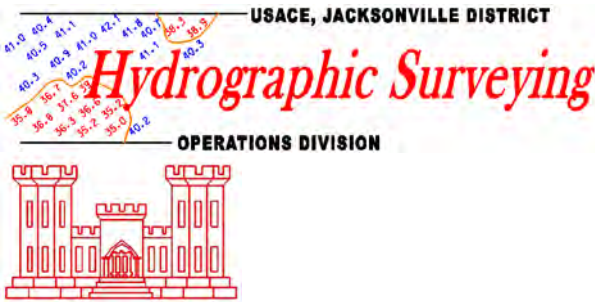

Field Conditions: Sea state and weather conditions varied, but remained within survey tolerances.

Prepared and Submitted By: Matthew R. Staley, Geodesist, USACE Jacksonville District.

EM 1110-2-1003
30 Nov 13

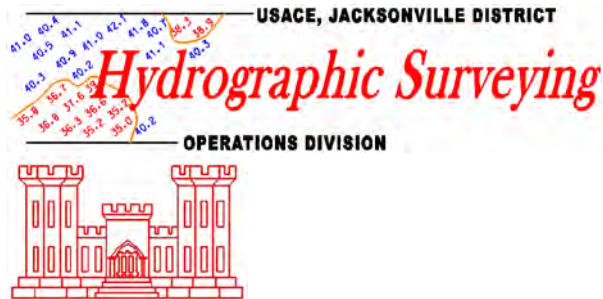

MAP SHEET NOTES:

REFER TO SURVEY NO. 11-031

ELEVATIONS ARE IN FEET AND TENTHS AND REFER TO THE NOAA REPORTED MLLW TIDAL DATUM RELATIVE TO THE 1983-2001 TIDAL EPOCH.

TIDAL REDUCTIONS WERE OBTAINED USING REAL-TIME KINEMATIC GPS AND REFERENCED TO MLLW UTILIZING A HYPACK KINEMATIC TIDAL DATUM MODEL. FILE NAME: "SPC-FL-WEST-2010-12-07.KTD." THE REFERENCE GAGE WAS NOAA GAGE 8726364 AT MULLET KEY.

ALL ELEVATIONS ARE BELOW THE CHART DATUM UNLESS PRECEDED BY A (+) SIGN.

PLANE COORDINATES ARE BASED ON THE TRANSVERSE MERCATOR PROJECTION FOR THE WEST ZONE OF FLORIDA AND REFERENCED TO THE NORTH AMERICAN DATUM OF 1983 (NAD 83).

THIS SURVEY WAS PERFORMED WITH A MULTIBEAM SWEEP SYSTEM USING REAL-TIME KINEMATIC GPS POSITIONING. WITH THE FOLLOWING REFERENCE BASE LOCATION – "TH-89 USE"

VERTICAL MEASUREMENTS WERE MADE USING AN R2 SONIC 2024 MULTIBEAM SYSTEM.

<u>SURVEY VESSEL</u>	<u>DATE OF SURVEY</u>	<u>AREA</u>
SB JACKSONVILLE	19, 24, 27, 28 JAN 2011	MULLET KEY CUT
SB JACKSONVILLE	16 FEB & 16 MAR 2011	MULLET KEY CUT
SB JACKSONVILLE	3 & 4 MAY 2011	EGMONT KEY CUT-2
SB JACKSONVILLE	12 MAY & 6, 9, 21, 22 JUN 2011	EGMONT KEY CUT-1

THE INFORMATION DEPICTED ON THIS MAP REPRESENTS THE RESULTS OF SURVEYS MADE ON THE DATES INDICATED ABOVE AND CAN ONLY BE CONSIDERED AS INDICATING THE GENERAL CONDITIONS AT THAT TIME. THIS CHART IS SOLELY FOR THE DISTRIBUTION OF AVAILABLE DEPTHS AT THE TIME OF SURVEY.

SURVEY ACCURACY STANDARDS, QUALITY CONTROL, AND QUALITY ASSURANCE REQUIREMENTS WERE FOLLOWED DURING THIS SURVEY IN ACCORDANCE WITH USACE EM 1110-2-1003, HYDROGRAPHIC SURVEYING, 1 JAN 02. BASED ON QA PERFORMANCE TEST RESULTS IT IS ESTIMATED THAT THIS SURVEY CONFORMS TO IHO "SPECIAL ORDER" NAUTICAL CHARTING STANDARDS.

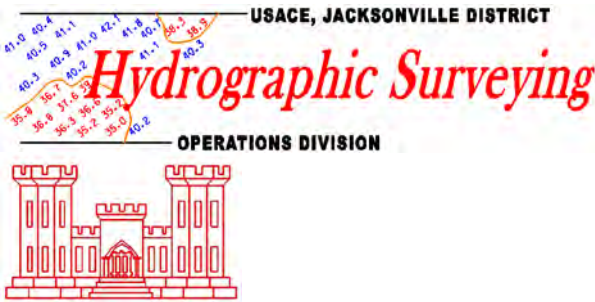

APPENDIX A PROJECT CONTROL

EM 1110-2-1003
30 Nov 13

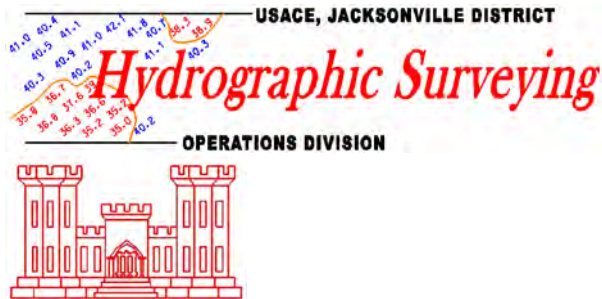

SURVEY DATASHEET (Version 1.0)

PID: AG0983
Designation: TH 89 USE
Stamping: TH 89 1976
Stability: Monuments of questionable or unknown reliability
Setting: Light structures (other than listed below)
Mark: G
Condition:
Description: Station is located in St. Petersburg Florida at Fort Desoto County Park at southeast end of Mullet Key. Mark is set flush in top of concrete sidewalk, approximately 800 feet south of the south edge of the parking area for Fort Desoto fishing pier, 84.5 feet southwest of the northeast end of concrete seawall, 62.7 feet west of the southeast corner of concrete seawall and 5.5 feet north of the concrete seawall.
Observed: 2010-12-02T13:31:00Z
Source: OPLUS - page 3 1009.28



X= 418,136.683sft
 Y= 1,192,166.878sft
 NAVD88 Elev= 4.032sft

REF. FRAME:	EPOCH:	SOURCE:	UNITS:	SET	DETAILS
NAD_83 (COR396)	2002.0000	NAVD88 (Computed using GEOID09)	m	PROFILE	
LAT: 27° 36' 41.33912" ± 0.004 m LON: -82° 44' 6.04376" ± 0.011 m ELL HT: -23.079 ± 0.025 m X: 715221.618 ± 0.012 m Y: -5610377.876 ± 0.019 m Z: 2938411.902 ± 0.014 m ORTHO HT: 1.229 ± 0.044 m		UTM 17 SPC 902(FL W) NORTHING: 3055367.285m 363373.191m EASTING: 328786.273m 127448.316m CONVERGENCE: -0.80432811° -0.34067366° POINT SCALE: 0.99996185 1.00000613 COMBINED FACTOR: 0.99996547 1.00000975			

CONTRIBUTED BY
[francis.m.woodward](#)
 US Army Corps of Engineers

Horizon View



The numerical values for this position solution have satisfied the quality control criteria of the National Geodetic Survey. The contributor has verified that the information submitted is accurate and complete.

30 Nov 13

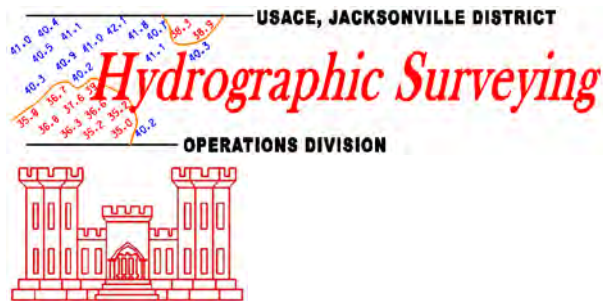

NOAA/NGS Control Data

[NOTE: THE FIELD REPORT CONTAINED COMPLETE NGS DATA SHEETS FOR CONTROL USED ON THIS CONDITION SURVEY. FOR BREVITY, THIS APPENDIX EXTRACTED ONLY THE FIRST FEW LINES FOR EACH CONTROL POINT]

```

DATABASE = ,PROGRAM = datasheet, VERSION = 7.85
1 National Geodetic Survey, Retrieval Date = JANUARY 5, 2011
AG0988 *****
AG0988 DESIGNATION - TH 89 USE
AG0988 PID - AG0988
AG0988 STATE/COUNTY- FL/PINELLAS
AG0988 USGS QUAD - ANNA MARIA (1981)
AG0988
AG0988 *CURRENT SURVEY CONTROL
AG0988
AG0988* NAD 83(1986)- 27 36 43. (N) 082 44 11. (W) SCALED
AG0988* NAVD 88 - 1.191 (meters) 3.91 (feet) ADJUSTED
AG0988
AG0988 GEOID HEIGHT- -24.31 (meters) GEOID09
AG0988 DYNAMIC HT - 1.189 (meters) 3.90 (feet) COMP
AG0988 MODELED GRAV- 979,158.8 (mgal) NAVD 88
AG0988
AG0988 VERT ORDER - SECOND CLASS II
AG0988

```

```

DATABASE = ,PROGRAM = datasheet, VERSION = 7.85
1 National Geodetic Survey, Retrieval Date = JUNE 1, 2010
AG7401 *****
AG7401 TIDAL BM - This is a Tidal Bench Mark.
AG7401 DESIGNATION - 872 6367 C TIDAL
AG7401 PID - AG7401
AG7401 STATE/COUNTY- FL/PINELLAS
AG7401 USGS QUAD - ANNA MARIA (1981)
AG7401
AG7401 *CURRENT SURVEY CONTROL
AG7401
AG7401* NAD 83(1986)- 27 37 00. (N) 082 43 35. (W) SCALED
AG7401* NAVD 88 - 1.121 (meters) 3.68 (feet) ADJUSTED
AG7401
AG7401 GEOID HEIGHT- -24.32 (meters) GEOID09
AG7401 DYNAMIC HT - 1.119 (meters) 3.67 (feet) COMP

```

EM 1110-2-1003
30 Nov 13

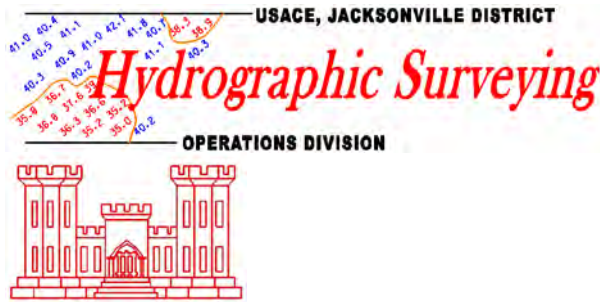

AG7401 MODELED GRAV- 979,159.0 (mgal) NAVD 88
AG7401
AG7401 VERT ORDER - SECOND CLASS I
AG7401

NOAA CO-OPS Tidal Bench Mark Data

U.S. DEPARTMENT OF COMMERCE
National Oceanic and Atmospheric Administration
National Ocean Service

[Datums Page](#)

Page 1 of 5

Station ID: 8726364 **PUBLICATION DATE:** 04/21/2003
Name: MULLET KEY, TAMPA BAY
FLORIDA
NOAA Chart: 11414 **Latitude:** 27° 36.9' N
USGS Quad: ANNA MARIA **Longitude:** 82° 43.6' W

To reach the tidal bench marks from the post office at the intersection of 1st Avenue North and 4th Street in St Petersburg, proceed west on 1st Avenue North for 4.0 km (2.5 mi) to 34th Street (U.S. Highway 19), then south on U.S. Highway 19 for 5.8 km (3.6 mi) to Pinellas Bayway, then west on Pinellas Bayway for 3.7 km (2.3 mi), continue south on Pinellas Bayway for 10.6 km (6.6 mi) to Anderson Boulevard, go SW on Anderson Boulevard for 1.69 km (1.05 mi) to old Fort DeSoto, then 0.6 km (0.4 mi) south along a paved road that leads to the parking area and fishing pier at the old fort. The bench marks are in the area between the fort and the fishing pier. The tide gage and staff were on the fishing pier.

T I D A L B E N C H M A R K S

PRIMARY BENCH MARK STAMPING: 6364 A 1976
DESIGNATION: 872 6364 A TIDAL

MONUMENTATION: Tidal Station disk **VM#:** 11302
AGENCY: National Ocean Survey (NOS) **PID#:** [AG0290](#)
SETTING CLASSIFICATION: Concrete culvert

The primary bench mark is a disk set in the top of a concrete culvert in Fort



Desoto Park between pier 1 and pier 2, 70 m (231 ft) north of the shoreline, 9 m (29 ft) east of the centerline of the asphalt road, and 3.11 m (10.2 ft) NW of the SE end of the culvert.

BENCH MARK STAMPING: 10 1957
DESIGNATION: 872 6364 TIDAL 10
ALIAS: TIDAL 10 STA III 34

MONUMENTATION: Tidal Station disk VM#: 11300
AGENCY: US Coast and Geodetic Survey (USC&GS) [PID#: AG5204](#)
SETTING CLASSIFICATION: Concrete base

The bench mark is a disk set in the top of the NE corner of a 1.83 m (6.0 ft) square concrete and shell base for a partially destroyed 12 m (40 ft) high observation tower, about 0.4 km (0.3 mi) SW of Fort Desoto, 89 m (291 ft) SE of the SE corner of the fishing pier, 32.09 m (105.3 ft) NE of a sea wall, and 1 m (3 ft) above ground level.

U.S. DEPARTMENT OF COMMERCE
National Oceanic and Atmospheric Administration
National Ocean Service

Station ID: 8726364 **PUBLICATION DATE:** 04/21/2003
Name: MULLET KEY, TAMPA BAY
FLORIDA
NOAA Chart: 11414 **Latitude:** 27° 36.9' N
USGS Quad: ANNA MARIA **Longitude:** 82° 43.6' W

T I D A L B E N C H M A R K S

BENCH MARK STAMPING: 12 1957
DESIGNATION: 872 6364 TIDAL 12
ALIAS: TIDAL 12 STA III 34

MONUMENTATION: Tidal Station disk VM#: 11301
AGENCY: US Coast and Geodetic Survey (USC&GS) [PID#: AG5203](#)
SETTING CLASSIFICATION: Concrete platform

EM 1110-2-1003
30 Nov 13

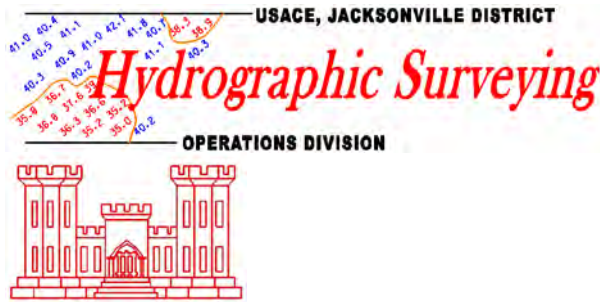

The bench mark is a disk set in the top of the SE corner of a 5 x 4 x 1 m (16 x 12 x 2 ft) high concrete platform, 180 m (592 ft) east of Bench Mark 10 1957, 122 m (400 ft) north of the shoreline, 46 m (150 ft) west of the centerline of the brick pavement, and 30 m (100 ft) north of the projected centerline of the east-west brick pavement.

BENCH MARK STAMPING: 6364 B 1990
DESIGNATION: 872 6364 B TIDAL

MONUMENTATION: Flange-encased Rod **VM#:** 11303
AGENCY: National Ocean Service (NOS) **PID#:** [AG9426](#)
SETTING CLASSIFICATION: Stainless steel rod

The bench mark is a flange-encased rod located near the west end of the sign for the fishing pier, 73 m (240 ft) NE of the east edge of the south entrance to the pier parking lot, 22.10 m (72.5 ft) SE of a paved road, 19.23 m (63.1 ft) north of the north edge of the parking lot, and 1.28 m (4.2 ft) NW of the SW corner of the fishing pier sign. The datum point is the top of a stainless steel rod driven 18.3 m (60 ft) to refusal, and encased in 5-inch logo cap.

U.S. DEPARTMENT OF COMMERCE
National Oceanic and Atmospheric Administration
National Ocean Service

Page 3 of 5

Station ID: 8726364 **PUBLICATION DATE:** 04/21/2003
Name: MULLET KEY, TAMPA BAY
FLORIDA
NOAA Chart: 11414 **Latitude:** 27° 36.9' N
USGS Quad: ANNA MARIA **Longitude:** 82° 43.6' W

T I D A L B E N C H M A R K S

BENCH MARK STAMPING:
DESIGNATION: PINELLAS
ALIAS: 872 6364 TIDAL

30 Nov 13

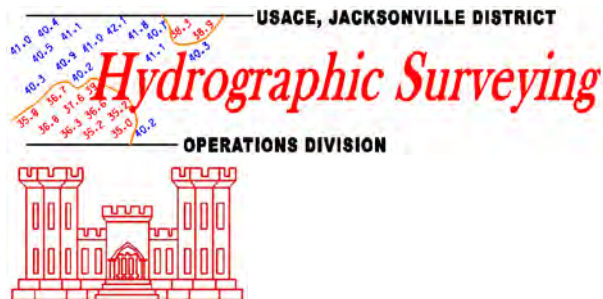

MONUMENTATION: Survey disk
 AGENCY: Pinellas County
 SETTING CLASSIFICATION: Sea wall

VM#: 11304
 PID#: [AG9428](#)

The bench mark is a disk set in the surface of the concrete sea wall on the NE side of the fishing pier, 83 m (272 ft) NW of the concession building, 57 m (186 ft) east of the rest room building, 52 m (169 ft) SE of the SE edge of the paved parking lot, 5 m (15 ft) NE of the NE side of the concrete pier, and 1 m (3 ft) below pier level.

U.S. DEPARTMENT OF COMMERCE
 National Oceanic and Atmospheric Administration
 National Ocean Service

Page 4 of 5

Station ID: 8726364 PUBLICATION DATE: 04/21/2003
 Name: MULLET KEY, TAMPA BAY
 FLORIDA
 NOAA Chart: 11414 Latitude: 27° 36.9' N
 USGS Quad: ANNA MARIA Longitude: 82° 43.6' W

T I D A L D A T U M S

Tidal datums at MULLET KEY, TAMPA BAY based on:

LENGTH OF SERIES: 2 Years
 TIME PERIOD: June 1990 - May 1991
 TIDAL EPOCH: 1983-2001
 CONTROL TIDE STATION: 8726520 ST. PETERSBURG, TAMPA BAY

Elevations of tidal datums referred to Mean Lower Low Water (MLLW), in METERS:

HIGHEST OBSERVED WATER LEVEL (12/03/1990)	=	1.041
MEAN HIGHER HIGH WATER (MHHW)	=	0.634
MEAN HIGH WATER (MHW)	=	0.556
NORTH AMERICAN VERTICAL DATUM-1988 (NAVD)	=	0.464
MEAN SEA LEVEL (MSL)	=	0.338
MEAN TIDE LEVEL (MTL)	=	0.331
MEAN LOW WATER (MLW)	=	0.106

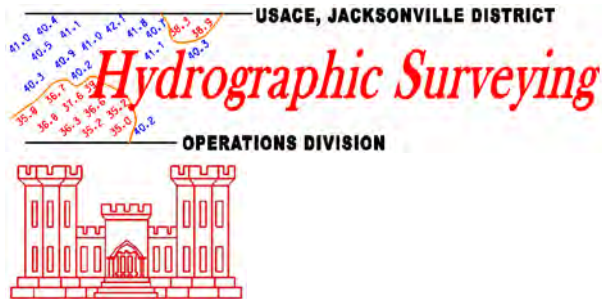

[National Geodetic Survey.](#)

NAVD 88 is a fixed datum derived from a simultaneous, least squares, minimum constraint adjustment of Canadian/Mexican/United States leveling observations. Local mean sea level observed at Father Point/Rimouski, Canada was held fixed as the single initial constraint. NAVD 88 replaces NGVD 29 as the national standard geodetic reference for heights. Bench mark elevations relative to NAVD 88 are available from NGS through the World Wide Web at [National Geodetic Survey.](#)

NGVD 29 and NAVD 88 are fixed geodetic datums whose elevation relationships to local MSL and other tidal datums may not be consistent from one location to another.

The Vertical Mark Number (VM#) and PID# shown on the bench mark sheet are unique identifiers for bench marks in the tidal and geodetic databases, respectively. Each bench mark in either database has a single, unique VM# and/or PID# assigned. Where both VM# and PID# are indicated, both tidal and geodetic elevations are available for the bench mark listed.

The NAVD 88 elevation is shown on the Elevations of Tidal Datums Table Referred to MLLW only when two or more of the bench marks listed have NAVD 88 elevations. The NAVD 88 elevation relationship shown in the table is derived from an average of several bench mark elevations relative to tide station datum. As a result of this averaging, NAVD 88 bench mark elevations computed indirectly from the tidal datums elevation table may differ slightly from NAVD 88 elevations listed for each bench mark in the NGS database.

EM 1110-2-1003
30 Nov 13

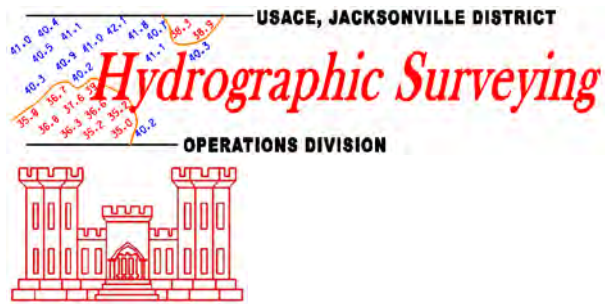

THIS PAGE INTENTIONALLY LEFT BLANK

APPENDIX K

Channel Framework Data for Coastal Navigation Projects

K-1. Channel Framework—Overview. Coastal navigation projects should have defined channel framework parameters. A channel control framework is simply a digital 2D "plat" of a project's current (authorized) geospatial dimensions and alignments. Optionally, the framework can include vertical information (channel depths and side slope parameters), original authorization data, and subsequent alignment and depth modifications. Consistent channel framework data is essential in transferring surveys to other organizations; in particular, NOAA. It is also useful in maintaining archival geospatial data, as may be needed when comparing surveys from different eras. Channel framework data are normally maintained in a MicroStation, AutoCAD, or ESRI GIS file. The use of a single GIS framework format is recommended for Corps-wide consistency (i.e., the USACE National Channel Framework initiative). It also has use in updating the USACE Digital Project Notebook. Periodic channel condition surveys are surveyed and processed within this consistent channel framework. A channel framework may include the following data.

- a. Horizontal. Georeferenced locations of a project's reference baselines (e.g., channel centerlines) and offset channel "boundary" limits (toes, basins, wideners, bulkheads, etc.). Channel coordinate locations should be referenced to the NOAA National Spatial Reference System (NSRS)—NAD83; relative to a fixed NSRS primary project control benchmark (PBM) and/or to a GNSS-based regional reference network (e.g., CORS).
- b. Vertical. Project depth grades should be defined to a hydraulic tidal model that relates the varying MLLW datum (defined by the NOAA "National Water Level Observation Network"-NWLN) relative to a NOAA tidal PBM, the GNSS (GPS) ellipsoid, and the NSRS NAVD88 datum. Great Lakes projects are referenced to the NWLN IGLD85 system.
- c. Authorization information. Listing of original authorization legislation and subsequent legislative modifications (realignments, widenings, deepenings, etc.).

K-2. Channel Framework Definitions.

- a. Federal Navigation Channel Project. A single or multiple channels by which Congress has authorized for the USACE to build and/or maintain. It will have a defined Civil Works Information System (CWIS) project level work item number.
- b. Federal Sub-Project. Within the Congressional language of a navigation project, a set section of the entire Channel. It will use its parent project's CWIS number for its funding needs.
- c. Authorized Channel. The authorized channel is defined by original, federal authorization legislation. This textual description, when manually tied to real world coordinates,

and represented by two channel toes in either an electronic or hard copy format, is known as the authorized channel.

d. **Constructed Channel.** The constructed channel may differ in dimension from the authorized channel due to funding shortfalls, or local geomorphic conditions that preclude or hinder the construction of the channel to authorized dimensions. Where constructed and authorized channel dimensions differ, both dimensions must be captured in the coastal channel framework. Where constructed channel and authorized channel are the same, a note stating such must be included with the data.

e. **Maintained Channel.** Ideally, the channel is maintained to its authorized dimensions. However, where this is not the case, a maintained channel dimension results. This maintained channel dimension should not, however, result in a new set of channel toes, centerlines, or stations. In fact, maintained channel dimensions need be reported in relation to the authorized and constructed dimensions of the channel via the channel condition report and survey. (Note that coordinates held within the National Channel Framework GIS database represent the maintained dimensions (widths, depths, lengths) rather than the authorized dimensions. Flexibility is given to the districts to highlight differences between constructed, authorized, or maintained framework within their local drawings.)

f. **Channel Reach.** The area within a project or sub-project traditionally used in reporting channel condition information via a channel condition report (ENG Form 4020/4021). A reach may, or may not, possess a one-to-one spatial relationship to a project or sub-project. Reaches, if used for reporting purposes, must describe the entire project length. Channel reaches are represented by individual vectors placed perpendicular to the channel centerline at the beginning/end of each reach. Channel reaches are denoted by a non-spatial table holding dimensions of each reach along with a stop/start point.

g. **Channel Quarter (Report of Channel Conditions).** For channels 100 to 400 ft wide use ENG Form 4021-R, Nov 90 and for channels 400 feet wide and greater use ENG Form 4020-R, Feb 2011. Channel quarters are polygons placed around quarters (or thirds for channels less than 100 ft wide). Any polygons generated should be considered an ancillary product.

h. **Channel Toe.** Channel toes represent external channel limits measured horizontally from and perpendicularly to the channel centerline. Channel toes form the boundaries which encompass entire federal projects and sub-projects. Toes are represented by single, continuous vectors extending from the beginning to the end of each federal project or sub project. The depth of the channel toe should be provided as an attribute attached to each channel vertex.

i. **Top of Slope Line.** The slope line is derived from the channel toe line depth and angle of slope values as provided with each station line. Where a line, starting from the channel toe, intersects project datum elevation zero (0), that is where the top of slope line is drawn. The channel slope angle, as well as depth of channel toe, is provided as an attribute of each channel

station. Top of Slope lines are represented by single, continuous vectors extending from the beginning to the end of each federal project or sub project. The depth of the channel toe should be provided as an attribute attached to each channel vertex.

j. Channel Stationing. A channel station is a reference line, primarily used during channel surveying and dredging operations, and meant to convey locations along a channel's length. A station is placed within a channel at consistent intervals, perpendicular to the centerline, and extends horizontally to each channel toe. Traditionally, channel stations are placed every 100 feet along a channel's length. In addition to positioning stations at regular intervals, stations also must be placed where channel toes change direction (horizontal inflection points). Channel stations are represented by individual vectors. Station names are conveyed through associated text fields. Since each district does their stationing differently, it is recommended that points be placed along the channel where there is point of intersection or a change in depth. If preferred, these points can be placed at regular intervals, but not required. The major issue with placing lines across the channel is that it is impossible to have a station that runs perpendicular to the centerline where the channel changes direction. Depending on the channel, one can end up without a single station that is actually perpendicular to the channel line; hence the stripped down component of a point along the centerline to capture location along the channel.

K-3. Channel Framework Feature Precisions and Datums. Table K-1 outlines recommended numerical precisions and datums to be used in channel framework CADD or GIS files.

a. In practical terms, the absolute geodetic location accuracy of an offshore, mathematically defined channel framework feature is dependent on (or no better than) the uncertainties in survey and dredge positioning systems. Before the mid 1990's, survey positional uncertainties were typically ± 20 to ± 50 ft—or worse. Current GPS dynamic survey techniques have reduced these uncertainties to a ± 6 ft level (Code DGPS), and as low as ± 1 to 2 ft (GPS/RTK methods). Survey precision (or repeatability) may be half these levels; however, these precision estimates would include constant positional biases.

b. Those developing channel framework parameters, or transforming datums, must consider the survey positional uncertainty relative to the mathematically defined precision of the framework. For example, 0.5 ft variations in NADCON/CORPSCON datum transforms at the same channel point are not significant given an inability to position a survey vessel to this accuracy.

c. The required CADD precision (or numerical resolution) of the mathematical channel framework coordinates is independent of their absolute datum accuracy (or survey accuracy). A fixed CADD resolution is needed for consistency in developing planned survey line files, survey data processing, and quantity computations.

Table K-1. Channel Control Feature CADD Precisions and Reference Datums

	Design File Precision	Reference Datum	Grid
<u>Horizontal</u>			
Channel Alignment Coordinates PIs, Toes, Basin Limits, etc.	nearest 0.1 ft	NSRS/NAD83	SPCS
Channel Alignment Orientation Bearings referenced to channel baseline PIs	nearest 1 arc-sec	NSRS/NAD83	SPCS
Channel Stationing-Offset Coordinates	nearest 0.1 ft	Local channel reach	Local
Primary Control PBMs (NSRS control) [reference PID only]	per published NSRS per published NSRS	NSRS/NAD83 NSRS/NAD83	SPCS Φ - λ

Vertical

Tidal PBMs—published NWLON/NSRS [indicate by reference to NOAA PID/ID]			
MLLW datum	per NWLON	NOAA NWLON	n/a
NAVD88 elevation	per NSRS/NWLON	NSRS/NAD83	n/a
Tidal Models	nearest 0.05 ft	NOAA NWLON	n/a

Design file precisions in no way reflect absolute geospatial accuracies

d. Channel framework files should indicate the channel coordinates are referenced to the North American Datum of 1983—“NAD83,” along with the appropriate State Plane Coordinate System (SPCS) zone identification. No year date should be appended to the NAD83 datum for the channel framework—i.e., NAD83 readjustment/realization dates should not be indicated (e.g., NAD83 (CORS), NAD83 (1996), NAD83 (1999), NAD83 (2007)). (Note that NAD83 is expected to be revised ca 2020—i.e., GRAV-D).

e. Coordinates/elevations of listed NOAA/NSRS PBMs or NOAA tidal station data should not be shown on the channel framework drawing, but should be referenced by NSRS PID or NWLON gage station ID to the to the appropriate NOAA database. This ensures that the NOAA database is accessed for the latest NOAA updates and readjustments, and that the framework document does not have to be continuously updated for these changes.

K-4. Recommended Requirements for Channel Framework Drawing Files. Table K-2 lists some of the basic framework data that should be documented for each coastal project. Not all of these parameters will be applicable to every project.

Table K-2. Recommended Details to be included on Framework Files.

	Plot Feature Symbol/Note/Tabulate
<u>Horizontal:</u>	
Reference Datum & Coordinate System	Note
Channel Alignment Centerlines	Plot and tabulate PI coordinates
Channel Azimuths between PIs	Note azimuth along centerline or baseline
Channel Limits	Plot and tabulate intersection coordinates
Channel Reaches (Cuts)	Note
Channel Widths	Dimension/note (verify w/authorizations)
Station-Offset (Range)	Plot leader notes from PIs or as required at other points
Primary Project Reference PBM (NSRS)	Plot PBM symbol and note/tabulate NSRS reference
Positioning Control Method	Note PIDs of RTK base PBM or VRN and calibration PBMs
<u>Vertical:</u>	
Vertical Reference Datum and Epoch	Note
Reference NOAA Tide Gauge	Plot gauge symbol and note/tabulate NWLON station ID
Tidal Model (MLLW-NAVD88)	Plot graphic MLLW-NAVD88 variations and/or reference to any digital model (e.g., KTD, VDatum). Note model date/version
Primary Project Reference Tidal PBM (NWLON)	Plot PBM and note references to NWLON & NSRS
Water Surface Measurement Method	Note PIDs of RTK base PBM or VRN and calibration PBMs (include survey procedures)

Optional Metadata:

Shoreline topo, general outline	Plot
Authorization Data	Note and/or reference location of file
Onshore/Offshore Placement or Borrow Area Details	If included in authorization--Plot or note
Archived (Superseded) Control Drawings	Note reference location of file
Side Slope Parameters	If included in authorization—Note
Jetties, breakwaters, bulkheads, etc.	Detail if included in authorizations

K-5. Horizontal Channel Alignment Framework Data. Coordinate data for points of intersection on a project should be tabulated on design drawings as illustrated in Figure K-4. Channel stationing is indicated at each centerline PI as shown in Figure K-5. (Note that the channel centerline may not always be the station-offset system reference baseline). PIs are designated by roman numerals consecutively throughout the project. Exterior intersection points on the channel limits (e.g., toes, basins, wideners) are noted by circled numbers on the drawings, as shown in the figure. Points are numbered consecutively throughout an entire project. Station-offsets of widener or basin coordinates may be added as required to define these irregular features. It is recommended that construction station-offset coordinates on navigation projects should adhere to the following convention.

- a. Start channel stationing consecutively “upstream” beginning from offshore PI.
- b. Reference the channel baseline to the channel centerline.
- c. Indicate channel orientation using grid bearings.
- d. Reference channel baseline offsets positive clockwise.

CHANNEL CENTERLINE		
P. I.	X-EASTING	Y-NORTHING
I	976.366.11	887.563.96
II	973.866.49	887.607.83
III	970.265.60	887.671.02
IV	968.763.59	887.143.89
V	967.763.18	886.687.28

CHANNEL LIMITS		
P. I.	X-EASTING	Y-NORTHING
1	976.369.62	887.763.93
2	973.870.00	887.607.79
3	970.377.03	887.869.10
4	968.707.50	887.283.18
5	967.700.90	886.823.73
6	967.102.58	886.550.64
7	966.042.58	886.570.99
8	966.015.72	885.171.24
9	967.225.50	885.148.02
10	967.900.85	886.385.68
11	968.819.68	887.004.61
12	969.939.14	887.397.48
13	970.657.13	887.464.12
14	973.862.98	887.407.86
15	976.362.60	887.363.99

Figure K-1. Tabular block of channel centerline PIs and channel toe coordinates.

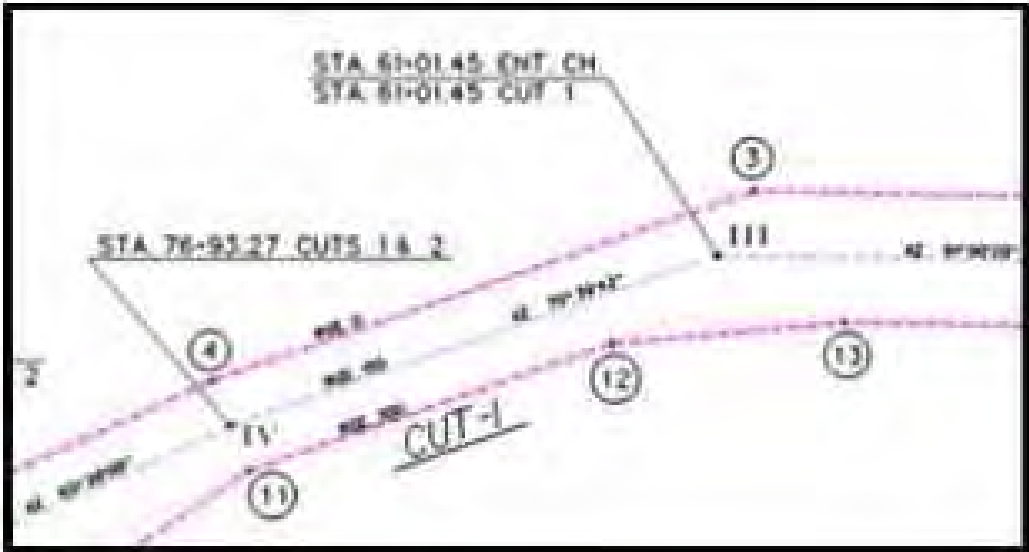

Figure K-2. Channel framework diagram of centerline and limit points.

K-6. CADD Standards for Channel Control Files. The following CADD standards are recommended for project condition survey features. These are taken from the "A/E/C CADD Standards" (currently Release 3.0—Model File Level/Layer Assignments (App A—Surveying & Mapping) and Standard Symbolology (App D)). The CADD levels should be assigned in framework drawings, using the graphic defaults in A/E/C Release 3.0, Appendix A.

V-ANNO-NOTE	General notes on datums, survey PBMs, procedures
V-CHAN-CNTR	Channel centerline alignment
V-CHAN-CNTR-IDEN	Text: tabulated PI SPCS coords, station-offset coords
V-CHAN-TOE	Authorized channel limits (toes)
V-CHAN-TOE-IDEN	Text: tabulated authorized channel limits
V-CHAN-LIMIT	Misc. project limits (wideners, basins, advance maint. etc.)
V-CHAN-LIMIT-IDEN	Text: Misc. limits -- tabulated limits & alignment points
V-CHAN-TEXT	Cut/Reach/Basin names

Other level assignments (not necessarily used in channel framework drawings)

V-CHAN-NAID	Navigation aids & text
V-TOPO-SHOR	Shoreline topo
V-TOPO-MAJR	Major depth contours
V-TOPO-MINR	Minor depth contours
V-TOPO-SOUN	Soundings/depths
V-TOPO-COOR-STAT	SPCS coordinate grid ticks & text

A/E/C Model File naming convention should be used for dgn files, e.g. "[project]V-SPmccf.dgn."

K-7. Authorization Data. The following example illustrates the type of authorization data that may optionally be included within a channel framework file. Maintaining and updating these data may prove difficult; thus, its application is optional. If this information is maintained in another database (e.g., Project Management), then it should not be duplicated in a framework file.

Table K-3 Additional Data in Channel Framework File

KEY WEST HARBOR, FLORIDA		
Condition of Improvement, 30 September 1996		
ACTS	WORK AUTHORIZED	DOCUMENTS
19 Sep 1890 (2)	The northwest entrance	H. Doc. 145/50/2 & H. Ex. Doc 39/51/1
28 May 1908	Removal of reefs in Main Ship Channel.	Specified in Act.

30 Nov 13

25 Jul 1912	The main ship channel and anchorage.	H. Doc. 706/62/2
18 Jul 1918	Removing the Middle Ground.	H. Doc. 185/65/1
14 Jul 1960	Channel into Garrison Bight. (1)	
23 Oct 1974	Channel into Key West Bight, turning basin, and breakwater.	S. Doc. 106/87/2
(1)	Approved by Chief of Engineers on 1 March 1963, for accomplishment under Section 107.	
(2)	17 Nov. 1988, two not completed jetties deauthorized, Public Law 99-662.	

PROJECT: Key West Harbor - Removal of coral heads and reefs from main ship channel and anchorage to provide a channel 30 feet deep and 300 feet wide; a channel 17 feet deep and a sufficient width for navigation in Northwest Channel; widening channel opposite wharves to 800 feet with a depth of 26 feet; provide a channel 8 feet deep by 100 feet wide along the north and east sides of Fleming Key and into Garrison Bight; a channel 12 feet deep by 150 feet wide extending from the 30-foot ship channel into Key West Bight, a turning basin 12 feet in the bight, and a granite-mound breakwater 800 feet long along the north side of the bight. Length of project channels is about 23 miles, including channel into Garrison Bight 3.75 miles, and channel into Key West Bight 0.6 mile.

EM 1110-2-1003
30 Nov 13

THIS PAGE INTENTIONALLY LEFT BLANK

APPENDIX L

Almond Lake Reservoir Survey and Area Capacity Curves (Baltimore District)

L-1. The following project illustrates a typical reservoir sedimentation survey for the purpose of updating area capacity curves. The overall project involved sedimentation surveys for seven reservoir projects in Baltimore District. The report for one of these projects is illustrated in this appendix. The single-beam hydrographic surveys on the reservoir were conducted by TVGA, Inc., Elma, NY. Another contractor subsequently completed the topographic mapping portion of the work. Baltimore District then merged the two files to obtain a DTM from which they computed reservoir storage area-capacities. St. Louis District managed the hydrographic and photogrammetric mapping contracts for the Baltimore District.

a. Task order scope of work. The following Scope of Work was sent to the contractor as part of a Request for Proposal on the project. This scope succinctly describes the work to be performed and deliverables.

Figure L-1 Scope of Work

**SCOPE OF WORK
TVGA ENGINEERING, SURVEYING, INC
ELMA, NY
SEVEN LAKES FOR BALTIMORE DISTRICT
HYDROGRAPHIC SURVEYS**

**CONTRACT NO. DACW43-96-D-0512
TASK (DELIVERY) ORDER NO. XXX**

1. Description of Work:

The Contractor shall perform hydrographic surveys in the Baltimore District at seven lakes to be used to update area capacity curves to reflect the changes in storage volumes as a result of sedimentation. The seven lakes are (1) East Sidney, (2) Whitney Point, (3) Bush Dam, (4) Stillwater, (5) Aylesworth Creek Lake, (6) Jennings Randolph, and (7) Almond Lake. The lakes are located in the vicinity of northern Pennsylvania, West Virginia, and New York.

2. Information Supplied by the Government:

- a. Copies of USGS Quadrangle sheet covering the five lakes with pertinent areas outlined.
- b. Copies of project maps for each lake.
- c. Copies of mapping specifications, for merging hydrographic surveys with the mapping being performed by others.
- d. Copy of list detailing specification for individual lake. Sounding range distance interval for the lakes are listed for each lake.

EM 1110-2-1003

30 Nov 13

e. Copy of memo from Baltimore District detailing survey requirements to be coordinated with the St. Louis District.

3. Work to be Performed by the Contractor:

The Contractor shall provide equipment, supplies, personnel, and survey boat fully equipped to perform control and standard hydrographic surveys utilizing differential global positioning system technology. Specific work shall include:

a. Take sounding along range lines spaced at 100 ft to 250 ft. intervals, but close enough so each lake bottom can be adequately defined for mapping purposes, for hydrographic surveys on the seven (7) lakes furnished in 2.b above. The surveys must be obtained during periods when each lake is below the summer conservation pool (elevation on list provided in 2.d above. The Contractor is required to maintain close coordination with CELMS-ED-HG (Bob Mesko) or CENAB-EN-GW (Bill Haines) to ensure water conditions are being met for each survey. Calibration for fathometer shall be obtained and submitted for each lake surveyed. The surveys shall meet the requirements for class I hydrographic surveys as stated in EM 110-2-1003, 30 October 1994, "HYDROGRAPHIC SURVEYING".

b. Gage readings shall be recorded twice each day for the nearest upstream and downstream gages where soundings are being taken. Also, if surveying in an area where lake gages may not accurately reflect water surface conditions, levels shall be run to water surface.

c. All surveys shall also be submitted to the St. Louis District in 3D CADD files fully operational on ARC/INFO GIS system. For hydrographic surveys, reference soundings to the National Geodetic Vertical Datum (NGVD).

d. The Contractor shall prepare a bathymetric contour map for each lake showing 1996 conditions, extending from the lowest points in each lake up to the summer conservation pool elevation. The desired contour interval is two (2) feet and the horizontal scale is 1 inch equals 200 ft, unless other scales become required to match the mapping being performed by others. Plots shall be provided for both the soundings data in NGVD and contours.

e. Paper check plots shall be provided to the Government for checking and reviewing of the finished product. The maps shall be prepared on standard engineering size drawings (30" x 42"). The standard Baltimore District title block shall be placed in the lower right corner.

f. Using the hydrographic surveys, compute elevation-area and elevation capacity relationships for each lake from the lowest point in the summer conservation pool elevation. The Contractor shall furnish data in both tabular and graphical format.

g. Visits to each project site shall be pre-coordinated (date, time, purpose) with Mr. William Haines, who will advise the dam operator. Upon arriving at a project site, St. Louis District personnel or their contractors shall check in with the dam operator before beginning work.

h. Lakes at the various projects are subject to rapid and frequent changes in water levels, depending upon hydrologic conditions. Field work should be scheduled and accomplished with the understanding that the lake levels may fluctuate daily or even hourly, and there may be times when vessels are prohibited on the lakes.

i. The Contractor shall compare the DGPS positioning system to a minimum of one known survey control point in the vicinity of each lake surveyed.

4. End Results Expected:

a. Listing (coordinates) of any additional horizontal control established. Include field books showing plan view, location, references, and procedures used to establish new points. Field books shall include neat sketches showing bearings, angles, and taped distances to at least three nearby distinct permanent objects.

b. Quality reproducible mylars and five black line copies of the 1996 contour maps and soundings. Electronic data files for bathymetry maps in both contour and elevation form, for use in an ARC/INFO system as described in para. 3.d above. Maps shall be prepared on standard engineering size drawings (30"x42"). The standard Baltimore District title block shall be placed in the lower right corner.

c. Fathometer scrolls showing sounding lines cross-referenced to plan view plots in 4.b. above, complete set of survey notes, 3.5-inch diskettes, and any other medium containing raw survey data. This package is to be accompanied by documentation indicating the data type, the data format, and general instruction for its retrieval.

d. New monuments established in the field as necessary to perform hydrographic survey.

e. Corps of Engineers Form DA 1959 completed with information concerning any new control points which may have been set.

f. Diskettes containing the 3D CADD digital data files of the hydrographic surveys, fully operational on the District ARC/INFO system.

g. Original and five copies of curves and tables for the 1996 elevation-area and 1996 elevation capacity relationships. Electronic data files for curves and tables will also be submitted.

h. Bi-weekly progress reports shall be submitted to the St. Louis District and Baltimore District. This report may be made electronically (e-mail) or via fax. The POC in Baltimore is Mr. J. William Haines, CENAB-EN-GW, Phone (410) 962-6768 and FAX (410) 962-4972.

5. Schedule and Submittal:

The Contractor shall prepare and submit all pertinent data to the Corps of Engineers, ED-HG (Attn: Bob Mesko), 1222 Spruce, St. Louis, MO 63103-2833 by 31 January 1997 for every project except Jennings Randolph Lake. For Jennings Randolph Lake all information and deliverables not later than 1 June 1997 shall be submitted. Close coordination is required with ED-HG (Bob Mesko) to ensure the surveys are being obtained during period of summer conservation pool and before draw down occurs. Incremental submittals of surveys are required for the District to comment on format and content of the data. Scheduled draw downs will occur in the fall at East Sidney Lake and Whitney Point Lake. Field work must be completed at these project not later than 15 November 1996. Jennings Randolph is already being drawn down for the winter season. Refilling normally occurs in the early spring, but remains at full conservation pool for only a few weeks before whitewater, water quality, and water supply releases begin. It is anticipated that the hydrographic survey for this project will be scheduled for late March or early April 1997.

Hydrographic surveys, bathymetric maps, and area/capacity computations may be submitted to the Baltimore District and St. Louis District as projects are completed.

EM 1110-2-1003

30 Nov 13

6. Time Extensions:

In the event these schedules are exceeded due to causes beyond the control and without fault or negligence of the contractor, as determined by the Contracting Officer, this delivery order completion date will be extended one (1) calendar day for each day of delay.

b. Final survey report for Almond Lake. Following is the final survey report submitted by the contractor in May of 1997 transmitting the sedimentation survey results for one of the seven reservoirs included under the task order.

Figure L-2 Survey Report

SURVEY REPORT

ALMOND LAKE, NY
CANACADEA CREEK
SUSQUEHANNA RIVER BASIN
HYDROGRAPHIC CONDITION SURVEY

CONTRACT DACW43-96-D-0512 (ST. LOUIS DISTRICT)
TASK (DELIVERY) ORDER NO. 003

TVGA Engineering, Surveying, P.C. was requested by the US Army Engineer District, Saint Louis to provide Professional Hydrographic Surveying Services to the US Army Engineer District, Baltimore under Delivery Order Number 003 of Indefinite Delivery Contract DACW43-96-D-0512. TVGA's general responsibilities related to this project consisted of the following:

1. Conduct a hydrographic condition survey to update area capacity curves that would reflect any changes in the storage volumes as a result of sedimentation. The survey operations were to be conducted at a time when the pool elevation was at/or above the recreation level. The limits of our survey were to extend to all portions of the lake which were navigable with a shallow water survey system.
2. Convey results of the field survey through preparation of deliverables that include but are not limited to: plan view mapping to present hydrographic data obtained by the survey and contours at a 2 ft interval and to provide an updated area/capacity table and curves.

RECORD RESEARCH AND SURVEY SETUP

TVGA retrieved 7.5-minute United States Geodetic Survey (USGS) quadrangle maps from in-house records to plan the survey. The contour depicting the recreation pool elevation of 1260' above the National Geodetic Vertical Datum of 1929 9 (NGVD 29) was digitized from the quadrangle maps and subsequently used to pre-plan the location of cross sections to be surveyed. Cross sections were spaced at a 250' maximum interval and generally situated perpendicular to hydraulic flow--[see Figures L-1 and L-2]. The digitized cross sections were uploaded into Coastal Oceanographics' HYPACK Software and

subsequently used during field operations as a base reference for left/right navigation information on the survey vessel.

HYDROGRAPHIC CONDITION SURVEY

The survey was conducted at a time when the top of water elevation was above the recreation pool elevation of 1260'. An automated electronic survey system was used to collect hydrographic survey data. The survey system was mounted on-board a 16' aluminum boat. The survey vessel's hull draft of approximately 0.9' and a propulsion draft of approximately 2.0' permitted safe navigation into 2.5' of water. Horizontal positioning data was supplied by an Omnistar, Inc. Model 6300A Differential Global Positioning System (DGPS). Depth data was provided by an Odom Hydrographic Inc. Model DF 3200 Mark II Echo Sounder equipped with a single 208 kHz / 3 degree transducer. Horizontal positioning data and digital depth data were logged directly onto a Toshiba 4400C laptop computer equipped with Coastal Oceanographics' HYPACK Hydrographic Survey Software. HYPACK Software was utilized to plan the survey, display real time vessel navigation information and review survey data on a daily basis.

The survey was performed in accordance with Class I accuracy specifications as described in the US Army Corps of Engineers Engineering and Design Manual EM 1110-2-1003, dated October 31, 1994 and titled Hydrographic Surveying. A generalization of specifications contained in the above EM manual that were implemented during field survey operations included but were not limited to:

1. A daily check and/or calibration of the echo sounder to verify and/or adjust for draft, squat and sound velocity. The Daily Depth Sounder Calibration Logs are included in Section H of this report.
2. A relative check of the Omnistar positioning system was made on a daily basis. This was accomplished by recovering and subsequently comparing the published geodetic coordinates of a National Geodetic Survey (NGS) survey marker with geodetic coordinates derived by the Omnistar positioning system. Xerographic copies of the field notes documenting the daily comparison are included in Section H of this report.
3. Collecting and reviewing data along cross section check lines (longitudinal sections).
4. Compensation for system latency.

Reasonable care was taken in the preparation and performance of the survey to ensure the best possible results. Copies of daily calibration reports are included Section H of this report. Weather and atmospheric conditions at the time of hydrographic survey did not in our opinion contribute any degradation in the expected survey results.

At the conclusion of the survey, the US Army Engineer District, Baltimore supplied TVGA with a Xerox copy of hourly pool elevation data recorded by an electronic gage located near the dam. As a precaution to loss of this electronic gate data, TVGA periodically interrogated the gage during survey operations and reported the data in a hard bound field book.

PREPARATION OF PROJECT DELIVERABLES

The hydrographic survey data was up-loaded onto a office based computer equipped with Coastal Oceanographics' HYPACK Hydrographic Survey software. HYPACK Software was utilized to sort, edit and apply water level corrections to digital cross section data. Digital depth data was compared against analog depth charts to correct (edit) depth spikes or false bottom returns caused by interference in the water column. Cross section data was sorted (thinned) to a 20' interval.

EM 1110-2-1003

30 Nov 13

The edited cross section data set was read into a Bentley Systems, Inc. MicroStation 95 Version 5.05 3D CADD format. The cross section data was reviewed and a series of terrain break lines were constructed through the low point of each cross section and around the perimeter of the lake. A Triangulated Irregular Network (TIN.) was developed by Intergraph Inroads Version 5.01 software. Contours at 1' and 2' intervals were derived from the digital TIN generated from field collected hydrographic survey data and digital terrain break lines. (Figure L-3)

Plan view mapping that shows final elevations from echo soundings and contours at a 2' interval was drafted at a scale of 1"=200'. The mapping was finalized using the aforementioned MicroStation software. The mapping is in compliance with the US Army Corps of Engineers, Engineering and Design Manual EM 1110-1-1807, dated July 30, 1990 and titled Computer-Aided Design and Drafting (CADD) Systems. Copies of this mapping plotted at ½ the original size are included in Section E of this report.

The contours generated at a 1' interval were read into Eagle Point software through a Drawing Interchange Format (.DXF). This software was used to compute areas and storage volumes at a 1' interval. The digital ASCII reports produced by Eagle Point software were read into Microsoft Excel Version 7.0. to finalize the area/capacity table and curves.

A system of checks and balances were performed on data to ensure the data's integrity and completeness. A comparison between new and old area/capacity data revealed some differences. The reasons for these differences can most likely attributed to the dynamic environmental conditions (sediment transfer) inherent to this type project, dissimilarities in methodology and equipment used to conduct the original field survey and the new survey and methodology used to compute the storage capacities.

POINTS OF CONTACT (Phone 716-655-8842)

Project Manager: Clinton E. Johnson

Field Work: Aaron C. Kennerly

Processing: Scott E Waite

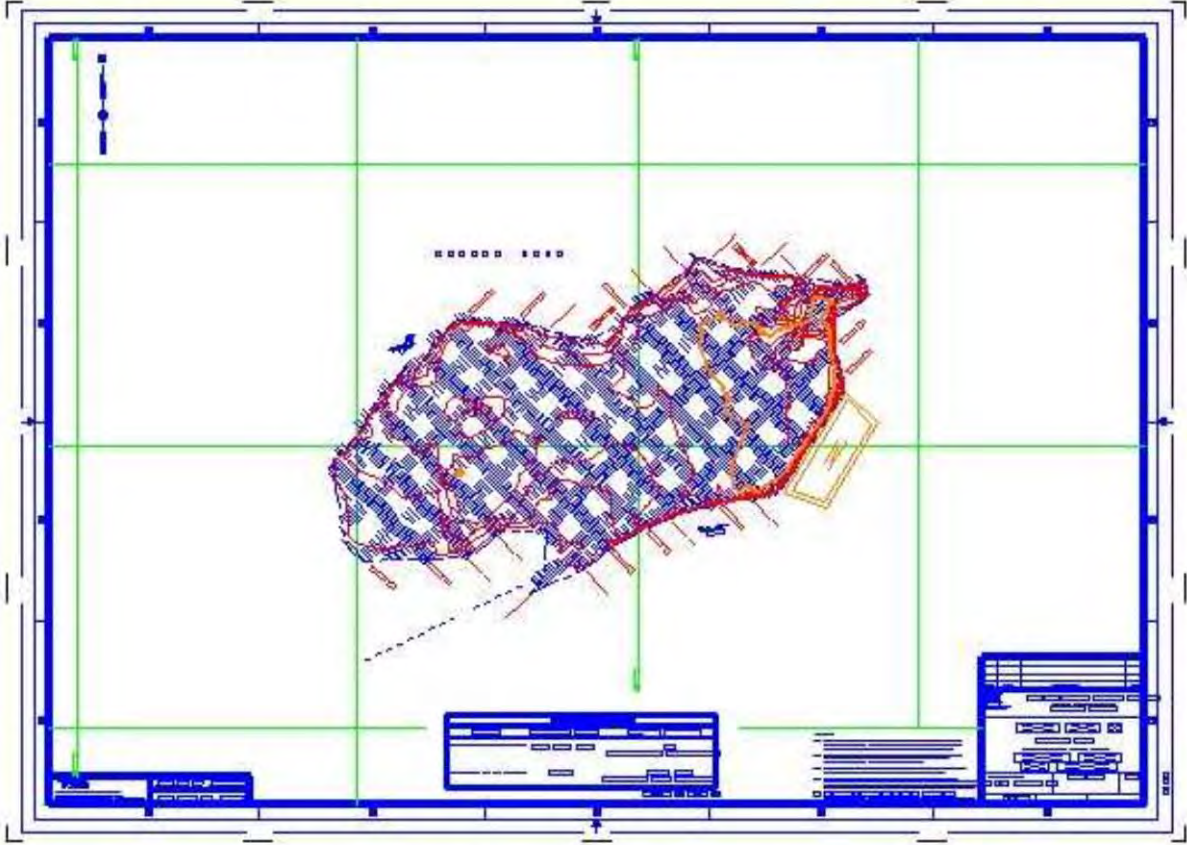

Figure L-3 Line spacing and alignment layout for hydrographic surveys of Almond reservoir. (TVGA, Inc.)

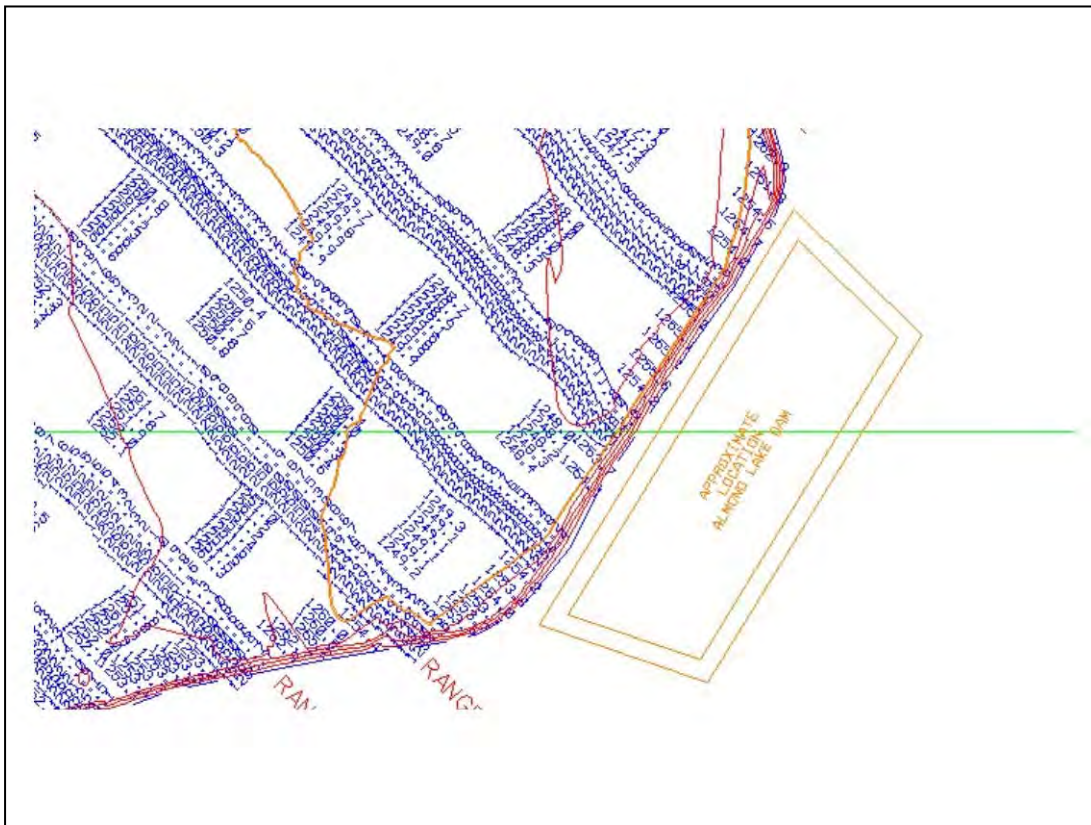

Figure L-4. Detail of survey vicinity Almond Lake Dam. 2-ft contours shown on drawings--1-ft contours used to compute storage capacities. (TVGA, Inc.)

c. Area-Capacity Computations. The contractor submitted preliminary area-capacity computations between elevations 1244 and 1260 ft, using procedures described in the above report. The elevations between 1257 and 1260 ft were estimated using digitized quad maps. Once the subsequent photogrammetric DTM was delivered by Horizons, Inc., the district computed area-capacities using the full elevation range up to the top of dam at 1320 ft.

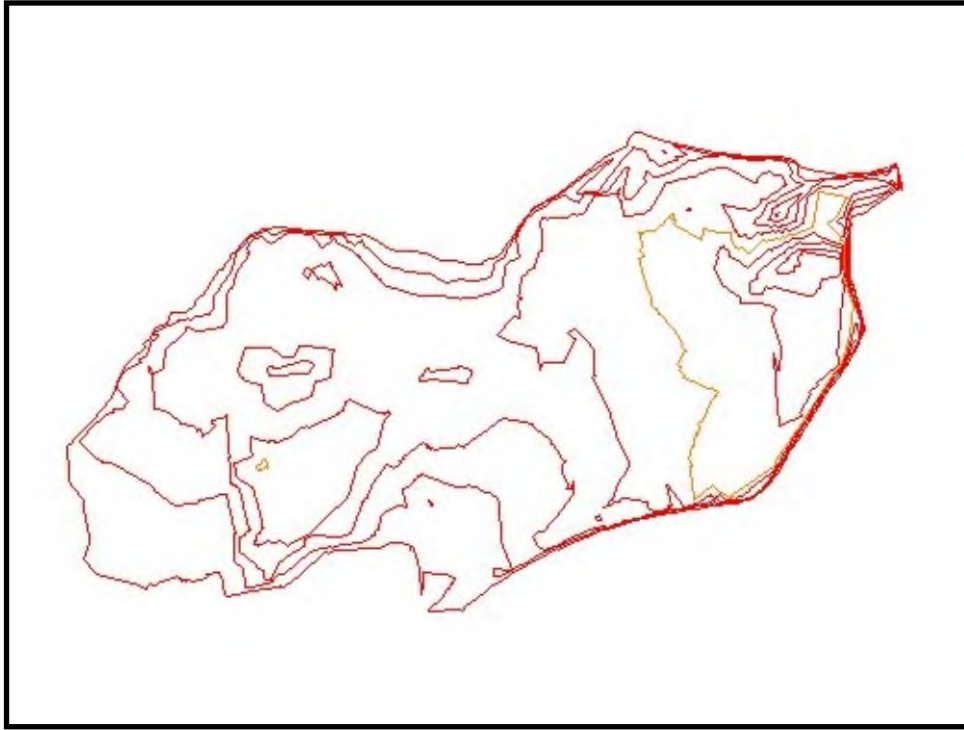

Figure L-5. Reservoir storage contours generated from Triangulated Irregular Network using MicroStation Inroads. Note that only 2-ft intervals are shown.

Table L-1 Area/Capacity Table

Area/Capacity Table -- Almond Lake, New York

Revised June 1998 by Baltimore District Water Control Management Section

Elevation NGVD 29 (ft)	Area Acres	Capacity Acre-ft	Inches of Runoff	
1229	0.0	0.0	< 0.01	Intake Sill elevation
1230	0.0	0.0	< 0.01	
.....				
.....				
1241	0.0	0.0	< 0.01	
1242	0.0	0.0	< 0.01	
1243	0.1	0.1	< 0.01	
1244	0.2	0.2	< 0.01	
1245	0.9	0.8	< 0.01	
1246	1.5	2.0	< 0.01	
1247	3.8	4.7	< 0.01	
1248	6.0	9.5	< 0.01	
1249	12	19	0.01	
1250	18	34	0.01	
1251	30	58	0.02	
1252	42	94	0.03	
1253	60	144	0.05	
1254	77	213	0.07	
1255	87	295	0.10	
1256	96	387	0.13	Areas below elevation 1260 ft from hydrographic surveys
1257	104	487	0.16	
1258	111	594	0.20	
1259	123	711	0.24	
1260	135	840	0.28	Conservation/Recreation Pool
1261	142	978	0.33	
1262	150	1125	0.38	Areas above elevation 1260 ft from aerial mapping surveys
1263	158	1278	0.43	
.				
.				
1300	492	13397	4.50	Spillway elevation
.				
.				
1306	540	16,277	5.47	

NOTES:

- A. Drainage area = 55.8 sq miles
- B. 1 in. of runoff = $55.8 \text{ mi}^2 * 640 \text{ ac/mi}^2 * 1 \text{ ft}/12 \text{ in.} = 2,976 \text{ acre-ft}$
- C. Areas and capacities computed using TVGA, Inc. hydrographic project survey dated 20-21 November 1996 and Horizon, Inc. photogrammetric mapping surveys from June 1998
- D. Spillway crest = 1,300 ft
- E. Area/capacities for all elevations not shown

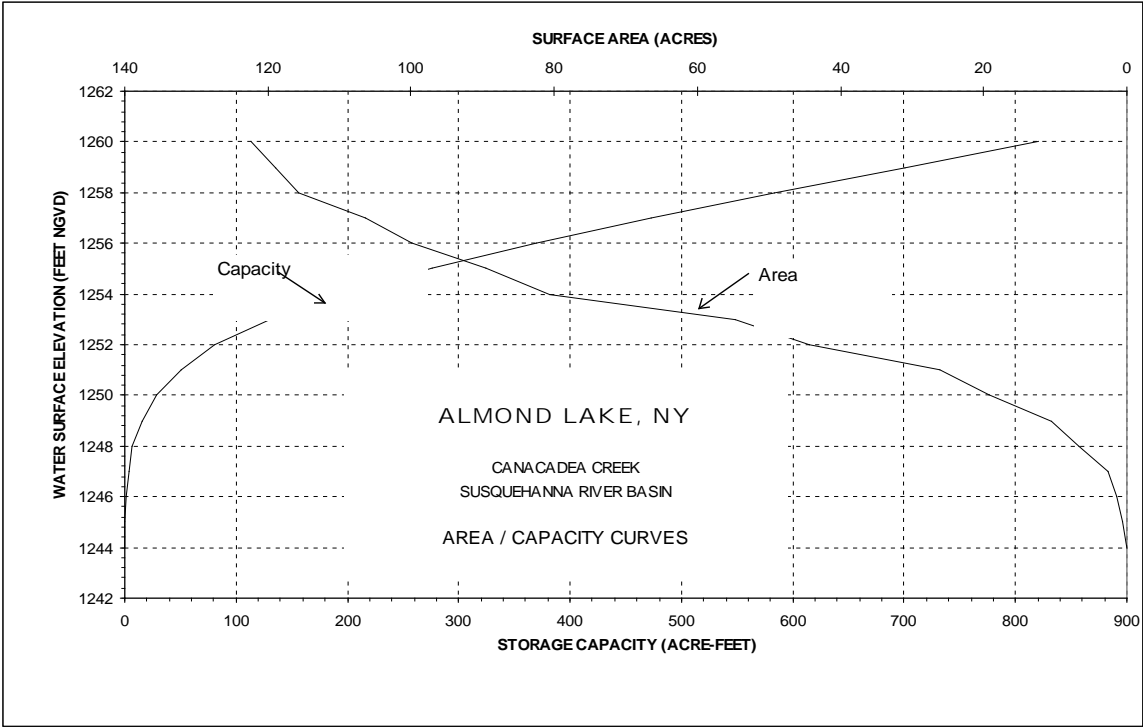

Figure L-6 Illustration of a standard Area-Capacity curve

EM 1110-2-1003
30 Nov 13

THIS PAGE INTENTIONALLY LEFT BLANK

EM 1110-2-1003

30 Nov 13

APPENDIX M

2010 Allegheny River Multibeam/Side Scan Sonar Scour Survey Report
(Pittsburgh District)

U.S. ARMY CORPS OF ENGINEERS
PITTSBURGH DISTRICT

Contract No. W911WN-10-D-0004

Delivery Order # 0005

2010 ALLEGHENY RIVER
MULTIBEAM/SIDE SCAN SONAR SCOUR SURVEY

SURVEY REPORT

BY:

Seaside
Engineering And Surveying, Inc.



Destin, FL

Crestview, FL

M-1

INDEX

CONTRACTOR: SUBCONTRACTOR:	1
OVERVIEW OF SERVICES PROVIDED:	1
FIELD SURVEY DATE:	1
PROJECT PERSONNEL:	1
SURVEY PREPARATION:	2
SURVEY AREA COVERAGE MAP:	2-3
DATA ACQUISITION:	3-4
Horizontal and Vertical Positioning – Navigation System:	3-4
Multibeam Echo Sounder (MBES):	3-4
SOUND VELOCITY PROFILER:	4
HYPACK / HYSWEEP SOFTWARE:	5-6
SURVEY SYSTEM CALIBRATION:	6
SURVEY CONTROL:	7
POSITION ACCURACY CHECK:	7-8
HYDROGRAPHIC DATA PROCESSING:	8
VERTICAL DATUM FOR SURVEY:	8-9
SURVEY VESSEL:	9
2D and 3D MICROSTATION V8 BASEMAPS:	9-10
SIDE SCAN DATA COLLECTION:	10-13
Side Scan Data Processing:	10-11
Side Scan Mosaics and Imagery:	12-13
CROSS SECTIONS OF DAM SCOUR DATA	14-15
SIDE SCAN SCREEN CAPTURES FROM EDGETECH DISCOVERY:	15-19
APPENDIX A - RESON SeaBat 8124 Multibeam Echo-Sounder	20-22
APPENDIX B – Applanix POSMV Wavemaster:	23-25
APPENDIX C – RESON SVP14 (Sound Velocity Profiler):	26-28
APPENDIX D – EdgeTech High Resolution Side Scan Sonar:	29-31
APPENDIX E – Topcon GR 3 GPS:	32-35
APPENDIX F – Scope of Work (SOW):	36-41

**U.S. ARMY CORPS OF ENGINEERS – PITTSBURGH DISTRICT
 CONTRACT NO. W911WN-10-D-0004 DELIVERY ORDER # 0005
 MULTIBEAM/SIDE SCAN SCOUR SURVEY
 ALLEGHENY RIVER – VARIOUS PROJECTS
 SURVEY REPORT**

CONTRACTOR:

Photo Science, Inc.
 104 S. Church Street
 West Chester, PA 19382
 Phone: (610) 344-0890
 URL: www.photoscience.com

SUBCONTRACTOR:

Seaside Engineering & Surveying Inc. (SEAS)
 P.O. Box 456
 Destin, FL 32540
 Phone: (850) 650-9563
 URL: www.seas-inc.com

**OVERVIEW OF SERVICES PROVIDED:**

Seaside Engineering and Surveying, Inc. provided vessel and surveying support necessary to perform multibeam/side scan hydrographic surveys and data processing at AR LD-5, AR LD-6, AR LD-8 and AR LD-9 Locks and Dams on the Allegheny River. The survey was performed as per the scope of work (SOW) for D.O. 0005 (see Appendix H) to comply with the “Mandatory Minimum Performance Standards for 200% “Minimum Survey Coverage Density” for Navigation & Dredging Support Surveys, as prescribed in EM 1110-2-1003, Table 3-1. The following report details the personnel, procedures and equipment used in the performance of this task order:

FIELD SURVEY DATES:

	Bathymetry	Side Scan
AR Lock & Dam 5	9 August 2010	10 August 2010
AR Lock & Dam 6	11 August 2010	11 August 2010
AR Lock & Dam 8	14 August 2010	16 August 2010
AR Lock & Dam 9	13 August 2010	13 August 2010

PROJECT PERSONNEL:

John Gustin, PSM - Project Manager responsible for Survey planning, Field crew coordination and report preparation. QC/QA field survey and data processing.

Walt Johnson - Survey Party Chief responsible for the collection of the field data and hydrographic sounding data daily processing and inspection.

David Shaw LSIT - Survey vessel operator, Instrument operator and Survey Crew Member.

Kelly Komula - MicroStation / AutoCAD technician responsible for CAD drawings; Digital Terrain Model (DTM) files; contours and ArcMap shape files

EM 1110-2-1003
30 Nov 13

James Barton, PE - Quality Control and Side Scan data processing and hydrographic data processing.

SURVEY PREPARATION:

Prior to beginning field work the following was completed by the project manager:

- ✓ The survey area was reviewed from the navigational chart and a survey plan was made.
- ✓ Survey schedule was coordinated through Steve Leblanc. The survey required zero flow and no power generation at each dam for safety and data quality.
- ✓ Planned survey lines were computed using HYPACK software. This was accomplished by importing the Inland Electronic Navigational Chart into HYPACK and using it as a reference to draw survey navigation lines. The hydro navigation lines were laid out parallel to the lock walls and spaced at intervals sufficient to provide 200% coverage with 50% overlap above and below the dam. Lines were also laid out parallel with the dam beginning at the apron and out (*see Survey Area Coverage Map below*) and spaced at intervals sufficient to provide 200% coverage with 50% overlap. Lines perpendicular to the dam were laid out to begin at the dam apron and ended just beyond the end of the river wall overlapping the parallel lines at the apron.

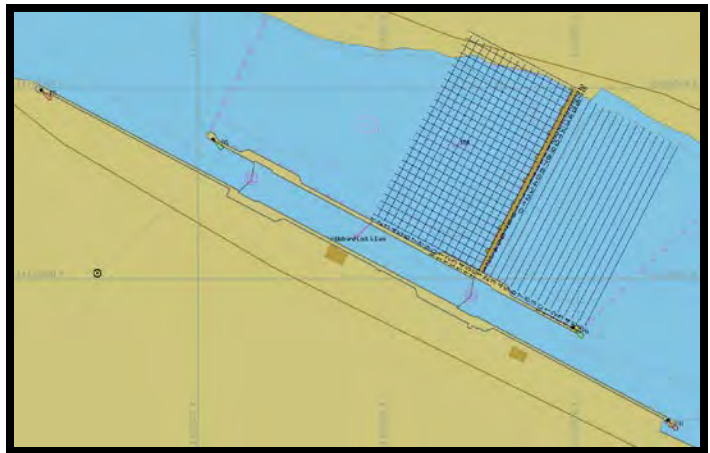

Planned survey lines parallel to lock walls below dam

SURVEY AREA COVERAGE MAP:



**AR Locks & Dam # 5
Survey Coverage Area**



**AR Lock & Dam # 6
Survey Coverage Area**



**AR Lock & Dam # 8
Survey Coverage Area**



**AR Lock & Dam # 9
Survey Coverage Area**

DATA ACQUISITION:

Horizontal and Vertical Positioning - Navigation System:

Real-time Kinematic (RTK) corrections for GPS positioning was used for the entire survey. SEAS broadcasted RTK corrections from a local control point (listed in the table below) at each Lock and Dam. A Topcon GR3™ dual frequency GNSS GPS Receiver (see Appendix B) Base Station with an internal radio modem was used to produce and broadcast the CMR+ RTK correction message. SEAS FCC Radio Station Authorization Registration Number (FRN): 0018646646 and Call Sign WQKD252. The GPS receiver onboard the survey vessel was an Applanix POSMV Wavemaster GNSS GPS/IMU. The POSMV provides ALL motion variables and timing data at high rates for Multibeam System Surveys. Employing state-of-the-art high precision gyros which are tightly coupled to supporting GPS, the POS MV provides continuous and accurate position and orientation data logging for vessel and sensor guidance. Reliable POS MV output is produced in severe sea conditions, during periods of blocked or intermittent GPS, in areas where GPS reception is compromised by multipath effects, or at times when position drift must be reduced and faster signal reacquisition is essential.



RTK GPS base station on lock wall @ Barkley

POS MV delivers a full six degree-of-freedom position and orientation solution measuring location, velocity, attitude, and heave plus acceleration and angular rate vectors. Applanix marine solutions are able to affix position and orientation data accurately under the most

demanding conditions, regardless of vessel dynamics, 200 times each second, making direct georeferencing and motion compensation for maritime remote sensing operations a productive and practical option. The Accuracy specifications for the POSMV are listed in the table below.

POS MV WaveMaster	DGPS	RTK	GPS Outage
Position	0.5 - 2 m1	0.02 - 0.10 m1	<3 m for 30 s outages, <10 m for 60 s outages
Roll & Pitch	0.030°	0.020°	0.040°
True Heading	0.030° with 2 m baseline	-	Drift less than 2° per hour
Heave	5 cm or 5%2	5 cm or 5%2	5 cm or 5%2

Multibeam Echo Sounder (MBES): Reson™ SeaBat 8124

All sounding data collection on the Cumberland River was performed with a RESON SeaBat 8124 Multibeam Echo Sounder (MBES) (see APPENDIX A for technical specifications). The SeaBat 8124 meets IHO and USACE Class 1 standards. The 8124 operates at 200kHz, has 120° swath coverage (3.5 x depth) and is capable of measuring up to 4,000 sounding per second.

The sonar head is mounted on a 4”x4” gear driven aluminum mast and is deployed through the centerline of the survey boat hull via a 36”x24” moon well. The moon well is located just aft of the back of the cabin bulkhead. The sonar head is lowered to the survey There are hatch doors in the bottom of the moon well that are opened during the survey.



Moon Well System

The topside (dry end) SeaBat components are the Sonar Processor and the Transceiver Unit. The sonar processor is a 19” rack unit that receives data from the transducer unit. The processor unit performs initial signal processing, beam forming, and bottom detection processing before exporting the data via Ethernet to the ship computer for storage, display, and further processing.

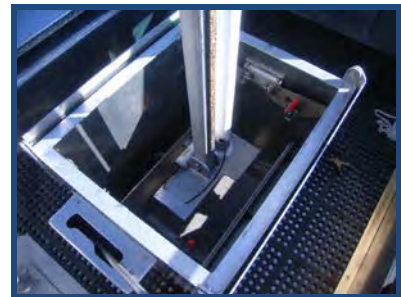

Multibeam in Moon Well

Sound Velocity Profiler:

A RESON SVP 14 to measure sound velocity profiles when performing multi-beam surveys. An accurate sound velocity profile is critical when processing multi-beam data. The use of the sound velocity profiler does not take the place of the standard bar check. The SVP 14 is lowered into the water at maximum wire speed of 3 m/s. As the SVP 14 is lowered it collects data every 0.5 meters in its internal memory. After the SVP 14 has been deployed and retrieved it is downloaded using the SVP Control software. The SVP Control software creates a Sound Velocity Profile which is used in HYPACK during data processing. (see APPENDIX C for technical specifications)



RESON SVP 14

HYPACK/HYSWEEP Software:

HYPACK and HYSWEEP™ software was utilized to display charts and collect all hydrographic data. A custom built rack mount CPU was used to run the data collection system. Data was collected parallel with the lock river walls. Data was collected parallel to the dam and the power house on the areas above and below the dam with these exceptions (could not survey above power house at Cheatham due to the debris boom and below Barkley because power generation could not be shut down completely). The lines were spaced to provide 200% coverage of the river floor. HYPACK / HYSWEEP was also used to edit the hydrographic survey data.



Ship Computer Running HYPACK

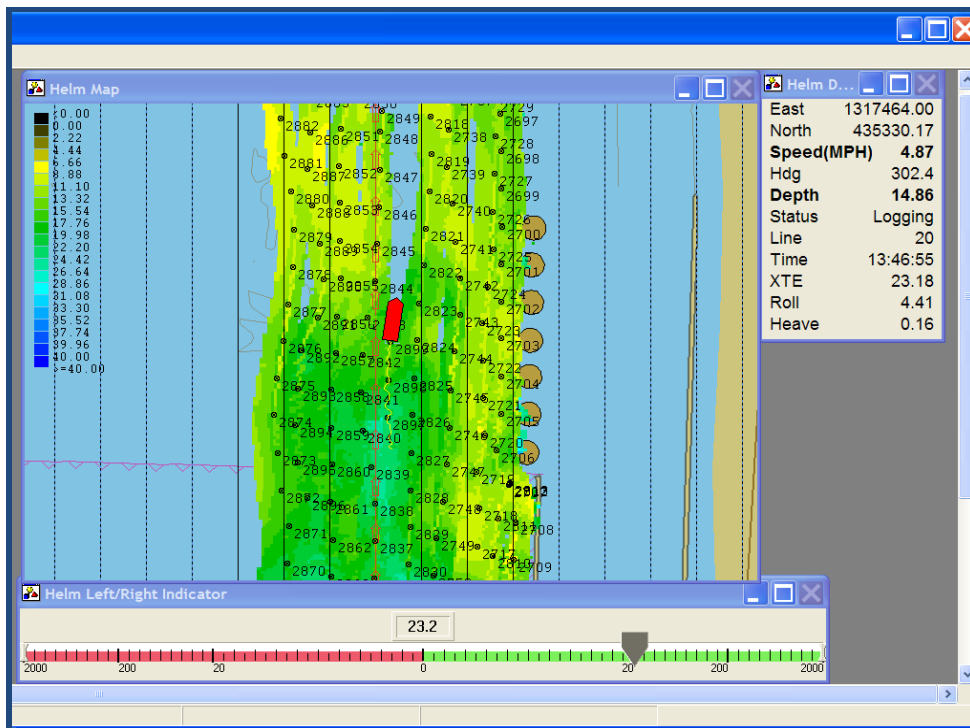

Helmsman Display is pictured below. This screen is used by the pilot to navigate the survey boat along either predetermined survey lines or the pilot can paint the screen. In the screen shot below the survey boat (red object in center of screen) is filling in an area missed due to shallower water. The width of the sweep is 3.5 times the water depth so when the water gets shallower the

sweep gets narrower. The depths are color coded as indicated by the legend on the left side of the Helm Map.

A second monitor displayed additional information about devices (GPS, sounder, heading), profile (profile view of depth data), plan view (map of survey with boat track etc...). The system also displayed Electronic Navigational Charts (ENC), Aerial photographs and other georeferenced imagery in the background during the survey. While the vessel was underway and surveying, the Crew Chief monitored the collection process. This involved watching the incoming data to be sure RTK positions and depths were consistent with the vessels location. The Crew Chief also kept notes on information that would be useful during the editing process. The system collected water depth with a location based on UTM Zone 17N coordinate system.

SURVEY SYSTEM CALIBRATION:

A **Patch Test** is a system calibration procedure for multibeam survey boats. It is nearly impossible to measure the relationships between the MBES sonar head, GPS antennas and the dynamic motion unit mounted positions and angles accurately enough for survey quality data, so the patch test is performed. In addition to pitch, roll and yaw (heading) angles, the patch test can be used to find positioning system latency. The **Latency Time** is the time delay in milliseconds (1 millisecond equals 1/1000th of a second) from when a device (instrument) takes a measurement to when it is received by the computer. Knowing the latency of each device allows the **Survey** program to correctly time tag the information from that device. Performing a patch test requires the survey boat to navigate lines over specific types of bottom terrain in a specific order.

The **Roll angle** is tested first by locating an area where the bottom is smooth and flat, and running a single line in opposite directions at normal survey speed. Over these bottom conditions, latency, pitch and yaw angles do not matter. Positioning **Latency** is tested next by running a single line twice, in the same direction across a prominent feature or up a steep slope, once at maximum survey speed then again as slowly as possible. During this test errors in pitch and yaw angles cancel out. Then **Pitch** is tested by running a single line in opposite directions across the same prominent feature or steep slope at normal survey speed.

The **Yaw offset** is an orientation offset which is added to ship's orientation. It is intended to be used with multiple transducer systems which are not oriented perpendicular to the ship's longitudinal axis. Yaw is tested last by running parallel lines in the same direction. Line separation is determined by the water depth at top of bank. After the data has been collected, the HYSWEEP Patch Test program will automatically calculate the correct roll, pitch and yaw mounting angles and positioning system latency.

Patch Test Results:

The Patch Test was performed on each day or each time the survey boat was put into water. The patch tests were processed in the field by the survey crew on-board the survey boat after the test was run. The results of the patch test were compared to previous patch test results to determine if there were any potential problems with the survey system. The results were recomputed during data processing and applied to the survey data.

SURVEY CONTROL:

Horizontal and Vertical control used for each of the Locks and Dams was provided by the Pittsburgh District Corps of Engineers and TerraSurv, Inc. The survey control stations were established by TerraSurv, Inc. at each project. The following table is a list of the control stations used for these projects

RTK GPS BASE STATION CONTROL DATA							
<u>Project</u>	<u>ID</u>	<u>SPCS</u> <u>Northing</u> <u>FEET</u>	<u>SPCS</u> <u>Easting</u> <u>FEET</u>	<u>UTM – N</u> <u>FEET</u>	<u>UTM – E</u> <u>FEET</u>	<u>ELEV.</u> <u>NAVD88</u>	<u>ELEV.</u> <u>NAVD88</u>
AR #5	M2	497,633.148	1,436,579.036	14,778,439.07	2,009,680.45	767.72ft	234.002m
AR #6	M3	509,126.921	1,460,963.512	14,790,821. 67	2,033,619.66	779.04ft	237.451m
AR #8	M3	573,370.641	1,491,221.043	14,856,126.23	2,061,479.64	807.07ft	245.995m
AR #9	M2	596,102.824	1,472,128.279	14,878,132. 83	2,041,563.77	831.54ft	253.454m

1. State Plane Coordinate System (SPCS) Pennsylvania South, NAD 1983 U.S. Survey Foot.
2. UTM Zone 17N – NAD 1983 U.S. Survey Foot.
3. Elevations are NAVD 1988 Feet and Meters.

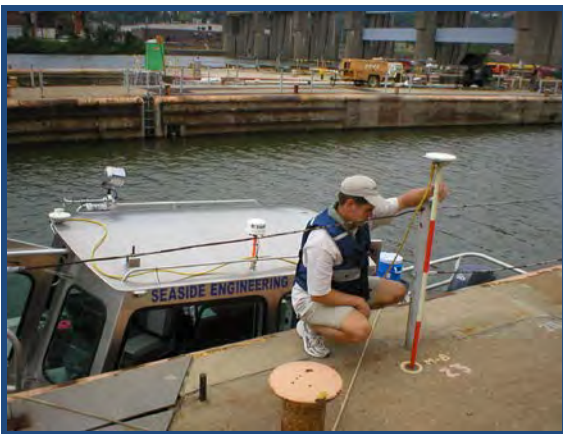

GPS position accuracy check (disk on lock wall)

POSITION ACCURACY CHECK:

The positional accuracy of the GPS navigation system was checked prior to any data collection at each project and at the completion of data collection. The position accuracy was also checked throughout the course of the project depending on the availability of local survey control. Following is the procedure which was used in performing the Position Accuracy Checks:

Navigation System Checks to Charted Fixed Objects:

Checks were made at lock wall and guide wall ends using the position of the end of the wall in the Electronic Navigational Chart as a reference point. Target positions were taken off of the end of the guide wall and lock wall at each lock and dam. The check was done by maneuvering the boat alongside the guide wall and measuring an offset distance from the GPS reference antenna on the boat to the side of the guide wall. The position of the GPS reference antenna was then recorded in HYPACK. The recorded position is then compared to the chart position to determine the accuracy of the navigation system. Visual checks are also made by the survey crew chief

during the survey by visually comparing the position of the survey boat as shown on the display in relation to an object in the navigation chart.

HYDROGRAPHIC DATA PROCESSING:

Multibeam Data Editing:

The Multibeam hydrographic survey data was edited with HYSWEEP™. All collected data; Positions, Heave Compensation, Heading and Soundings were displayed graphically and inspected for errors. A filter was set to remove obvious bad data (spikes). The range of depths encountered in the river was used to set a minimum and maximum allowable depth. A horizontal offset filter was also entered to filter erroneous position data that was obviously out of range, sometimes caused by bad PDOP, or loss of radio link with the GPS base unit.

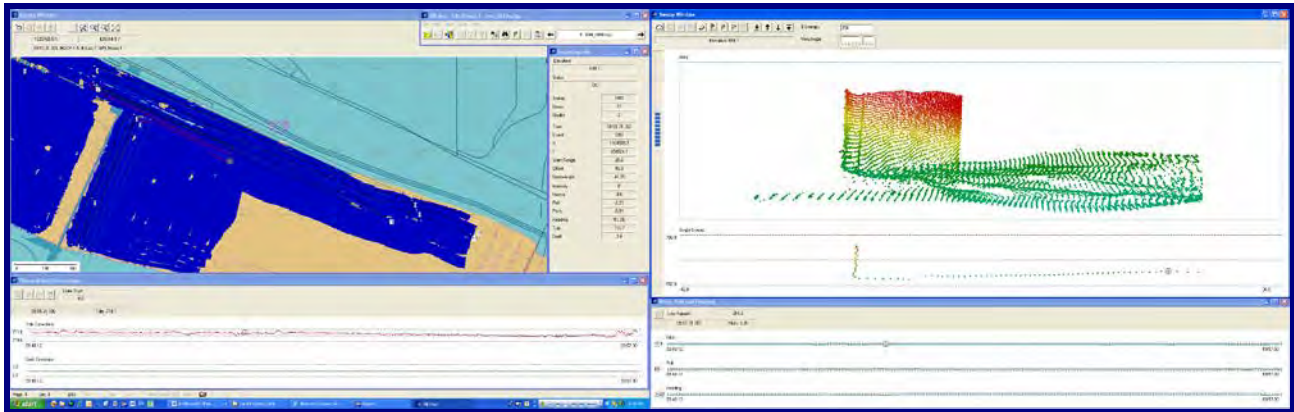

Screen capture of HYSWEEP Multibeam editing screen during data processing

RTK Tides was used for the elevation datum during processing. After the Multibeam data was edited, HYSWEEP™ Mapper was used to convert the edited data files into points (X, Y and Elevation). The multibeam system collects much more data than is needed to meet the project specifications. The Mapper program loads in all of the survey data and reduces the data to the desired density through gridding; ten and three foot grids were created in the form of a matrix (*.MTX) file, with square cells, then the soundings were loaded and reduced to one per cell. The selection process used the average depth of the cell.

The XYZ ASCII point files produced in HYSWEEP Mapper were imported into MicroStation V8 In-Roads and a DTM file was created. Contours were generated at one foot intervals from the DTM. The contours were inspected for anomalies and irregularities. The contours were then labeled. The XYZ elevation files were imported into Microsoft Excel and the depths were subtracted from the Project Pool elevation to produce ASCII depth files one for the upper pool and one for the lower pool. The XYZ depths files were imported into HYPACK and exported as dxf files. The dxf files were imported into Microstation V8.

Vertical Datum for Survey:

30 Nov 13

The Vertical Datum for the survey is North American Vertical Datum 1988 (NAVD88). RTK GPS was used to provide the vertical datum reference during the survey. The Latitude, Longitude and Ellipsoid Height of the survey control station was entered into the reference GPS receiver which was set up on one of the control station on a lock wall listed in the table above. The Geoid03 Region 7 geoid model was selected in HYPACK and the Height of the GPS antenna above the water surface was entered into HYPACK Survey. The Tide reading from HYPACK was then compared to the gage reading (reduced to pool elevation) provided by Lock personnel during the survey. This data was recorded in the field book during each survey. During data processing in HYPACK the electronic stored data is compared to the survey field notes for accuracy.

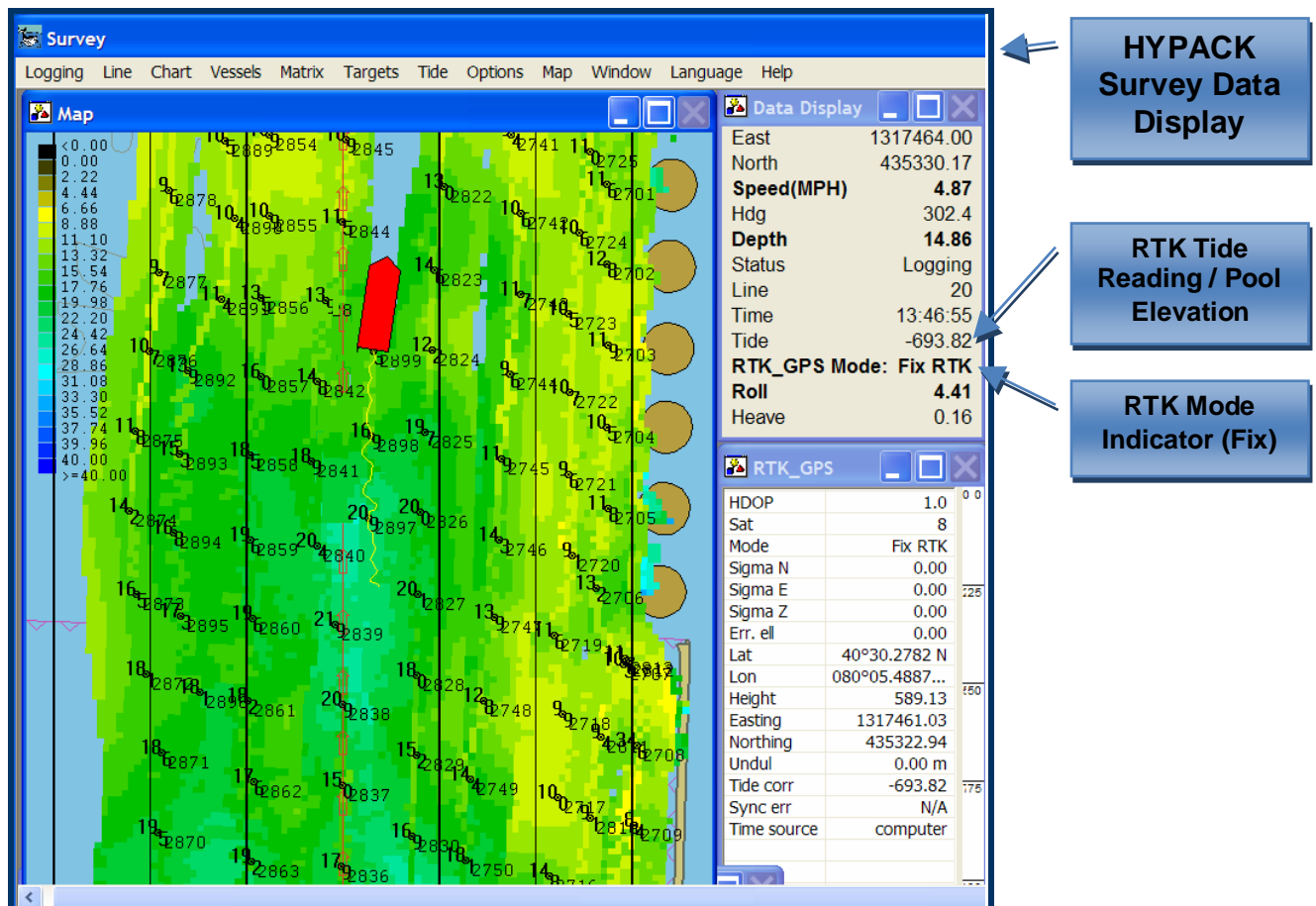

SURVEY VESSEL:

SEAS survey vessel used for this project is a 2009 Scully's aluminum survey boat with an overall length of 28 feet and an 8.5 foot beam. The hull is a shallow V type and drafts about 20" loaded. The boat has an 8 foot cabin. The rear deck is self bailing with a moon well for the deployment of singlebeam, multibeam transducers, or a fixed



Survey Boat - SEAS Surveyor II

EM 1110-2-1003
30 Nov 13

mount side scan. The vessel is powered by twin Yamaha 200 hp engines. Power on the vessel is provided by a Honda 6500 kW generator. The electrical system on the survey boat is equipped with GFCI Safety Protected AC outlets.

2D and 3D MICROSTATION V8 BASEMAPS:

SEAS Microstation technicians created 3D Contour Planviews and Color Planviews of each lock and dam structure. The 3D model files contain the lock and dam and powerhouse (if applicable), the survey control marks, survey control data, grid ticks, survey notes, river mile, shoreline, pool information, north arrow, graphic scale, project information and Pittsburgh District border sheet. The Color Planviews contain the colored terrain, and the Cross Section layout one above and one below the dam structure. The 3D model files are in the Universal Transverse Mercator (UTM) Zone 17N Coordinate System and the units are U.S. Survey Foot.

SIDE SCAN DATA COLLECTION

The side scan data was collected with an EdgeTech 4125-P dual High frequency sonar system (see Appendix D). This system is a 400/900 kHz dual frequency stainless steel towfish,



SEAS survey boat in lock chamber with side scan



EdgeTech Towfish mounted off the bow

combined with a small portable water resistant topside processor. The towfish has internal sensors which measure the roll, pitch, heading and depth and a 50 meter tow cable. The towfish was deployed over the bow of the survey boat. The side scan data was collected with EdgeTech's DISCOVER software. The horizontal and vertical offsets of the location of the tow point in relation to the survey boats navigation system reference frame and the cable layback are entered into the EdgeTech DISCOVER software.



**LOCK & DAM #5, ALLEGHENY RIVER SYSTEM
HYDROGRAPHIC SURVEY**

2010 UPPER SCOUR SURVEY

SURVEY NOTES:
 1. COORDINATES ARE UTM ZONE 17 NORTH, NORTH AMERICAN DATUM 1983 (NAD83), U.S. SURVEY FOOT.
 2. SURVEY VESSELS WERE A BOATY OF ALUMINUM BOLLON VESSEL...
 3. SURVEY CONTROLS WERE PROVIDED BY THE U.S. ARMY CORPS...
 4. CONTOURS ARE AT ONE FOOT INTERVALS.
 5. THE AREAS ABOVE AND BELOW THE DAM WERE SURVEYED ON JUNE 9-14, 2010.
 6. THE SURVEY WAS PERFORMED BY GEACIS ENGINEERING & SURVEYING, INC.

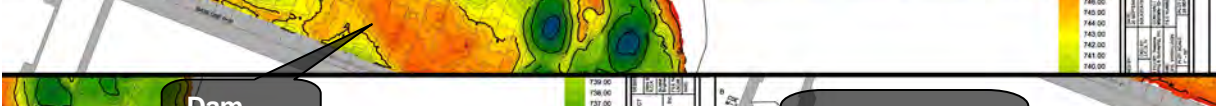
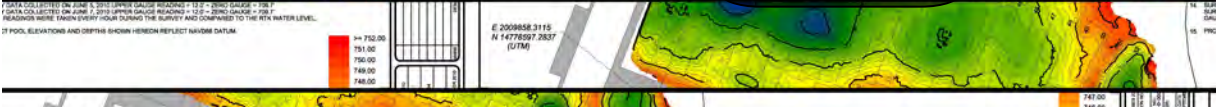
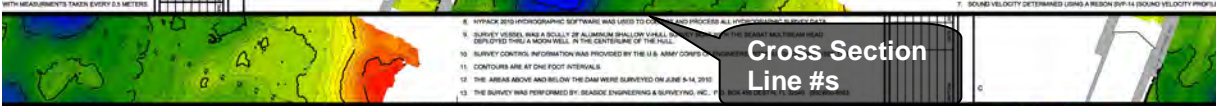

DATA:				CONTROL STATION C			
STATION	EAST (E70N FT)	ELEV. (NAVD83)	SURV. (DATE)	STATION	NORTH (E70N FT)	EAST (E70N FT)	NORTH (E70N FT)
1	2,028,817.014	776.00	2/21/04	M-1	407,871.402	1,424,271.308	14,778,883.2
2	2,029,046.448	787.25	2/24/04	M-2	407,833.148	1,424,879.208	14,778,930.0

Side scan data processing:

The side scan data was processed with Chesapeake Technology, Inc. SonarWiz Map software. The side scan data was collected in the native EdgeTech JSF file format and in XTF file format. The native JSF format files are imported into the SonarWiz Map software. The individual lines or passes are corrected for cable out and layback. The bottom track of the towfish is also corrected for each line. A mosaic of all of the lines is created and exported as a Geotiff as well as the individual lines. The EdgeTech DISCOVER software is the best way to view the side scan imagery. The raw side scan JSF files can be loaded into the DISCOVER program and played back.



EdgeTech 4125 Towfish and Topside Processor

The DISCOVER program has been provided on the submittal disk.

DISCOVER Software

Select the Disk tab of the control panel to load and playback side scan imagery

Browse to the desired JSF file and press the play button.

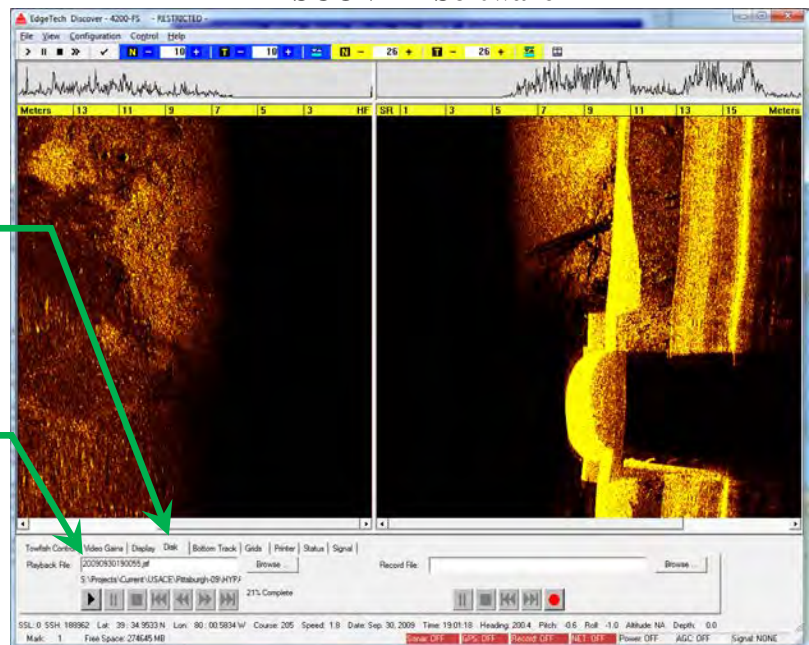

The side scan data was processed to create mosaics at each project. The mosaics are georeferenced

TIFF images. The mosaics are created from a compilation of the single passes/lines of the High (900kHz) and Low (400 kHz) side scan data. Georeferenced TIFF images have also been created for each individual pass/line of the high resolution side scan data. An example mosaic in Google Earth and single pass image is shown below.

SIDE SCAN IMAGE SINGLE PASS ABOVE AR - 6 LOCK & DAM



EM 1110-2-1003
30 Nov 13

SIDE SCAN IMAGE MOSAIC ABOVE CHARLEROI DAM



(GOOGLE EARTH KMZ FILE)

CROSS SECTIONS OF DAM SCOUR DATA:

For each dam surveyed scour, SEAS technicians created cross sections of areas above and below the dam. A baseline was created in MicroStation along the center of each dam. The baseline is not monumented in the field but the UTM Coordinates of the beginning and end points are listed in each of the drawings. The sections were created perpendicular to the baseline at 25' spacing. The cross section alignment was then created in HYPACK using the line editor. The coordinates

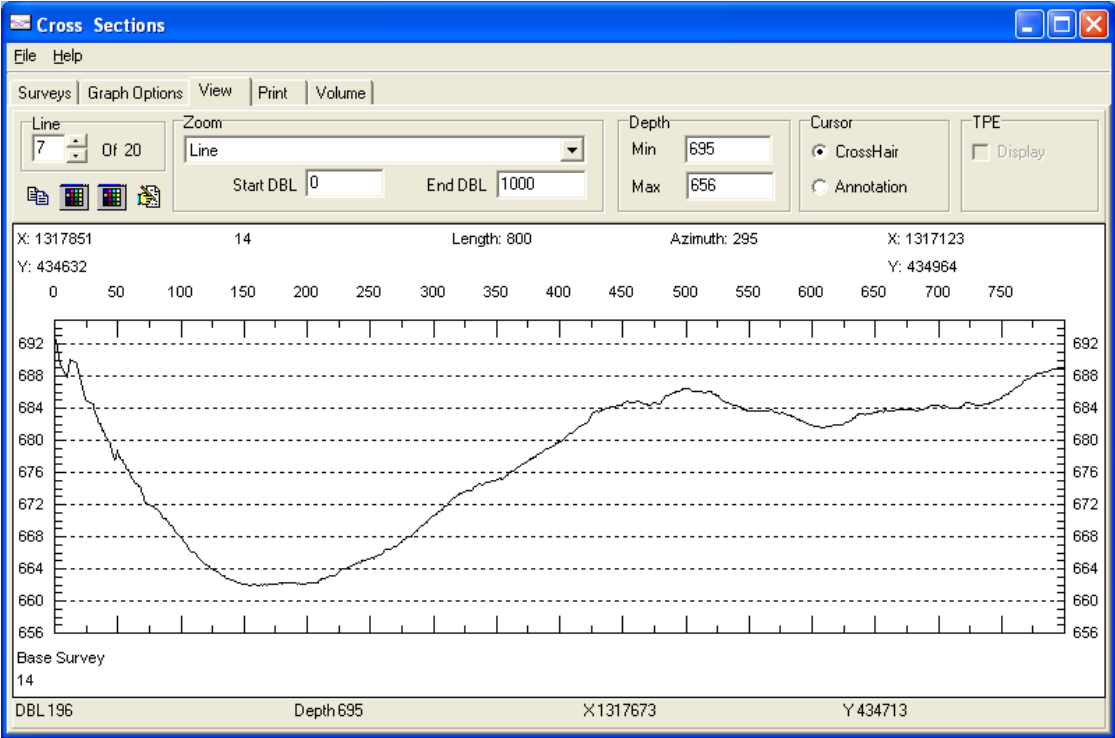

View of cross section station in HYPACK

for each cross station was and offset at

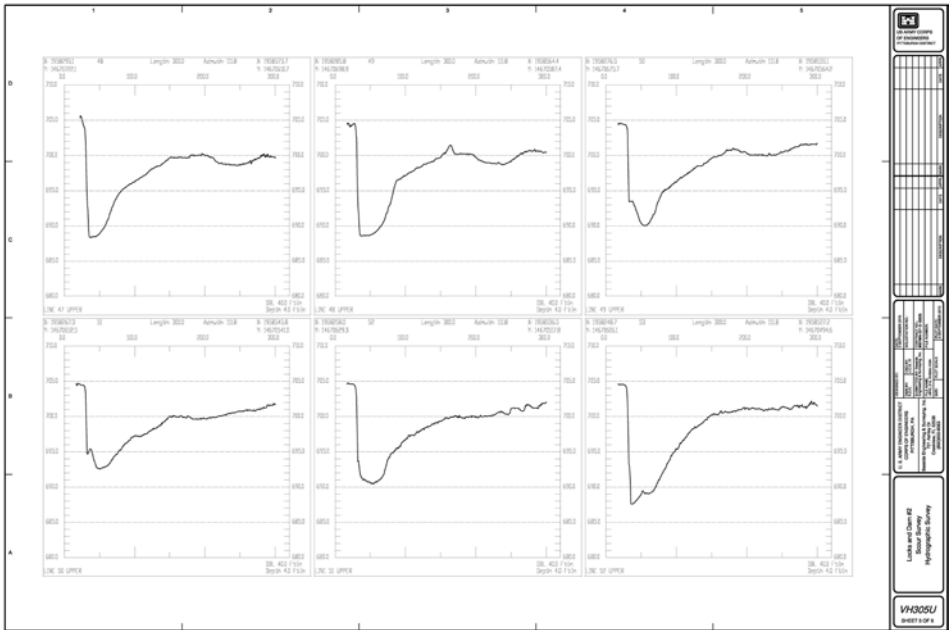

end of section 0+00 entered then 25 foot

MicroStation Cross Section sheet above Braddock Dam

EM 1110-2-1003
30 Nov 13

intervals to the end station. A TIN was created in HYPACK from the edited multibeam data. The cross sections were pulled through the TIN data. The cross sections were then exported out of HYPACK into a DXF file and imported into MicroStation. A sample Cross Section is shown below with the pertinent information pointed out.

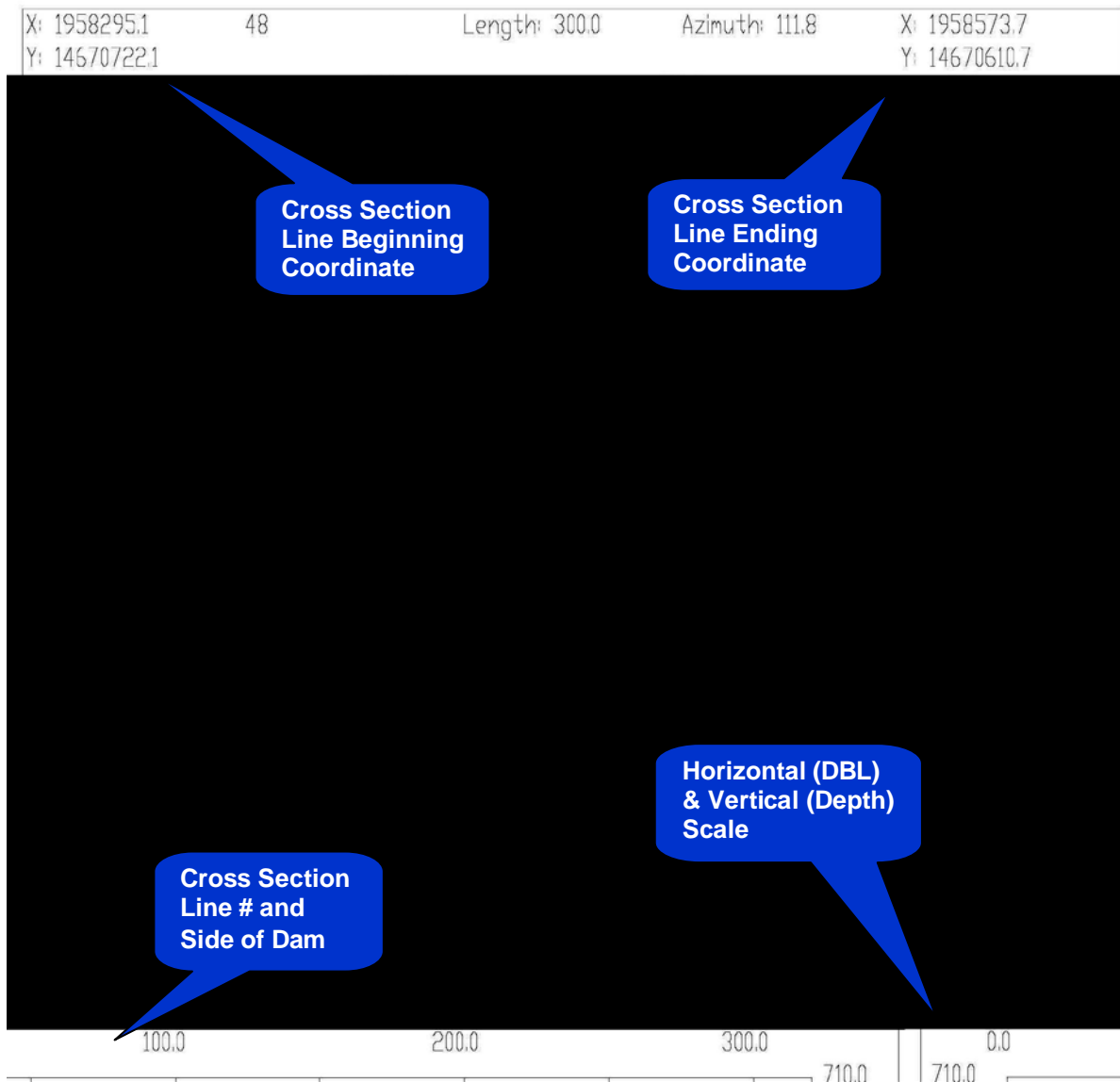

SIDE SCAN SCREEN CAPTURES FROM EDGETECH DISCOVERY:

The raw side scan JSF files can be loaded into the DISCOVER program and played back. The screen shots on the following pages were captured from the playback of the side scan data.

AR LD-5 Lower Guard Seal and Gate Seal

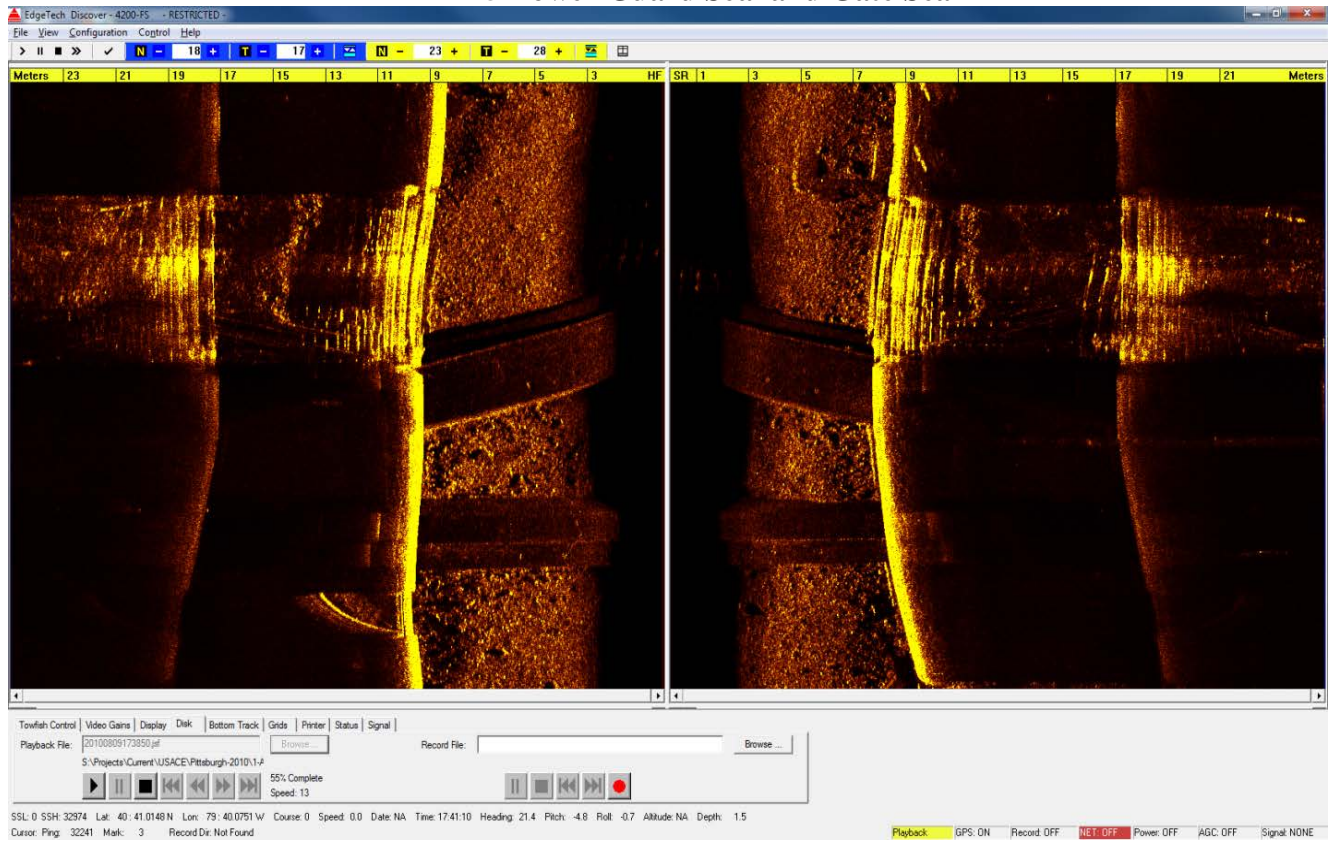

AR LD-5 Power Plant Intake Area

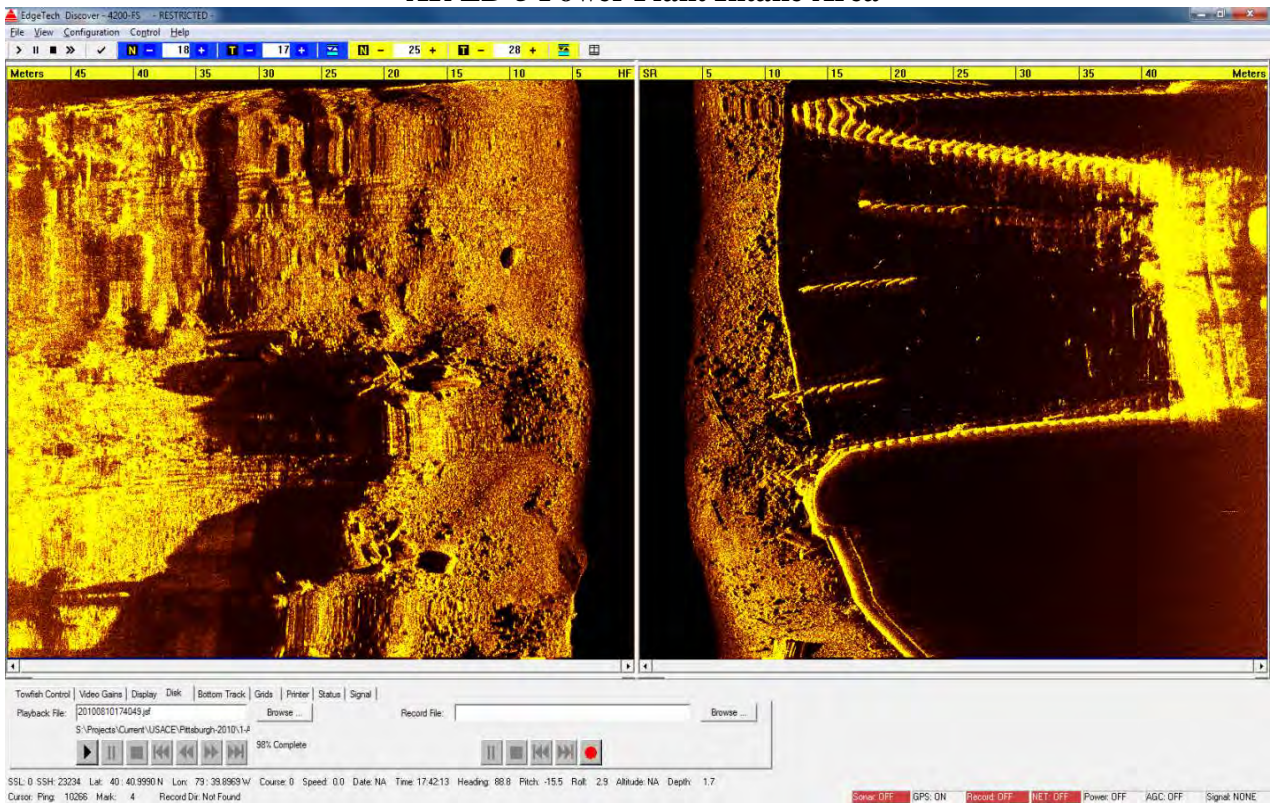

EM 1110-2-1003
30 Nov 13

AR LD 6 Lower end of River Wall

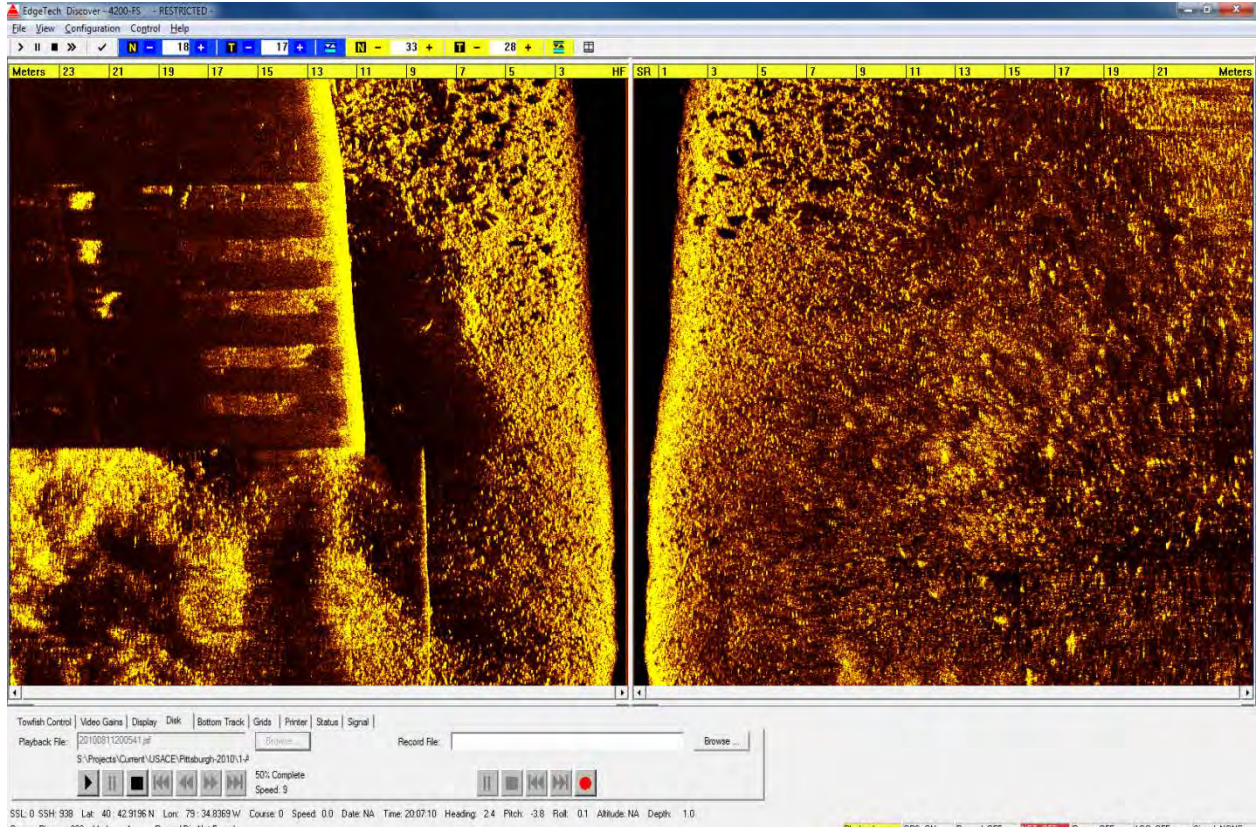

AR LD 6 Above Dam @ Entrance to Power Plant

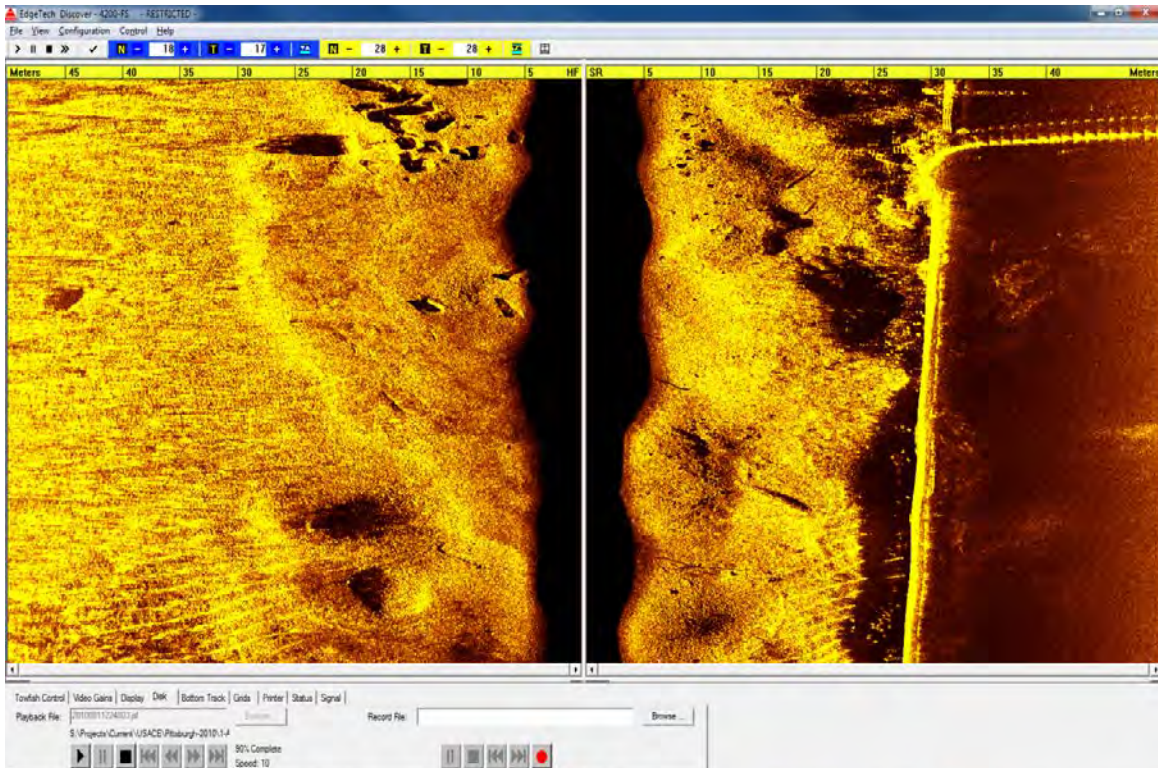

AR LD 6 Upper End of River Wall

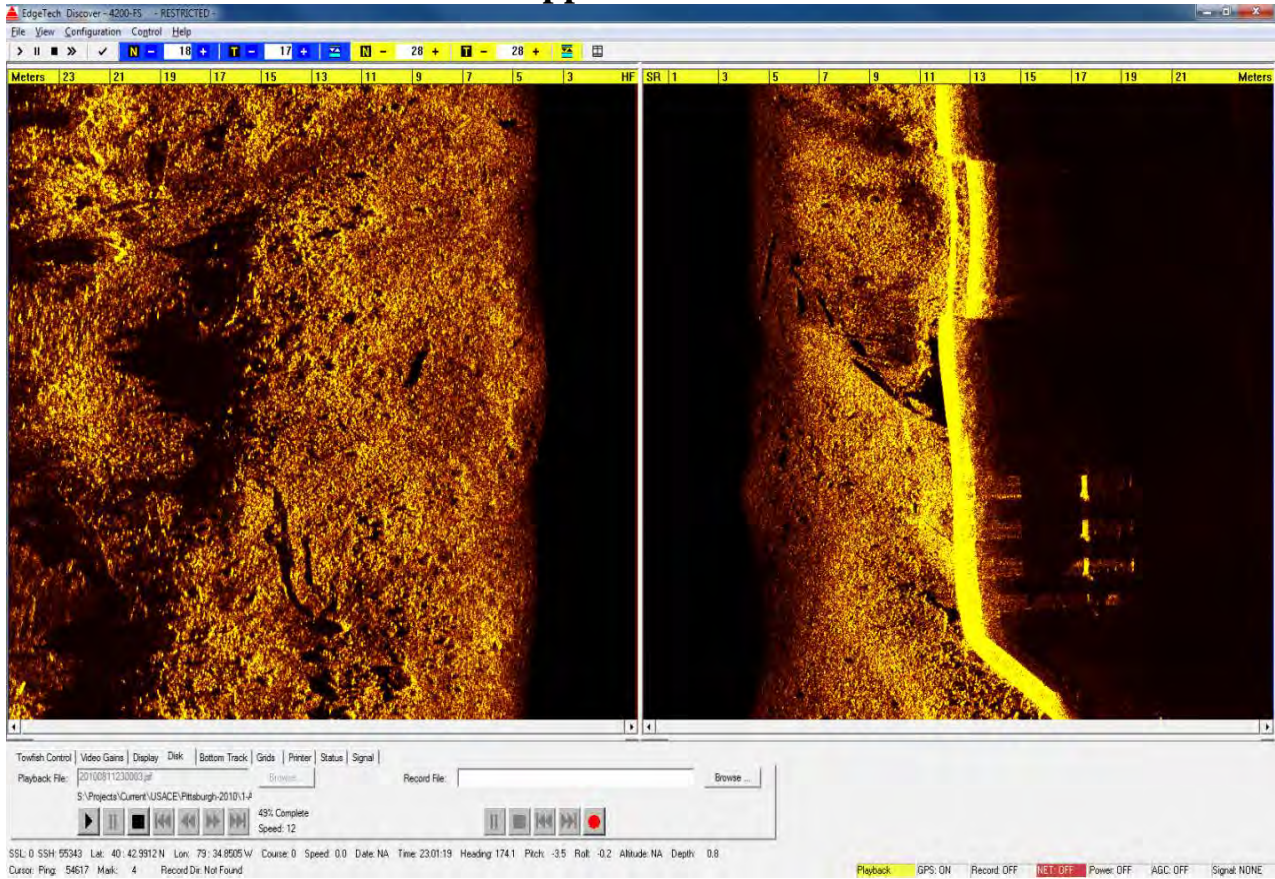

AR LD 9 Below Dam

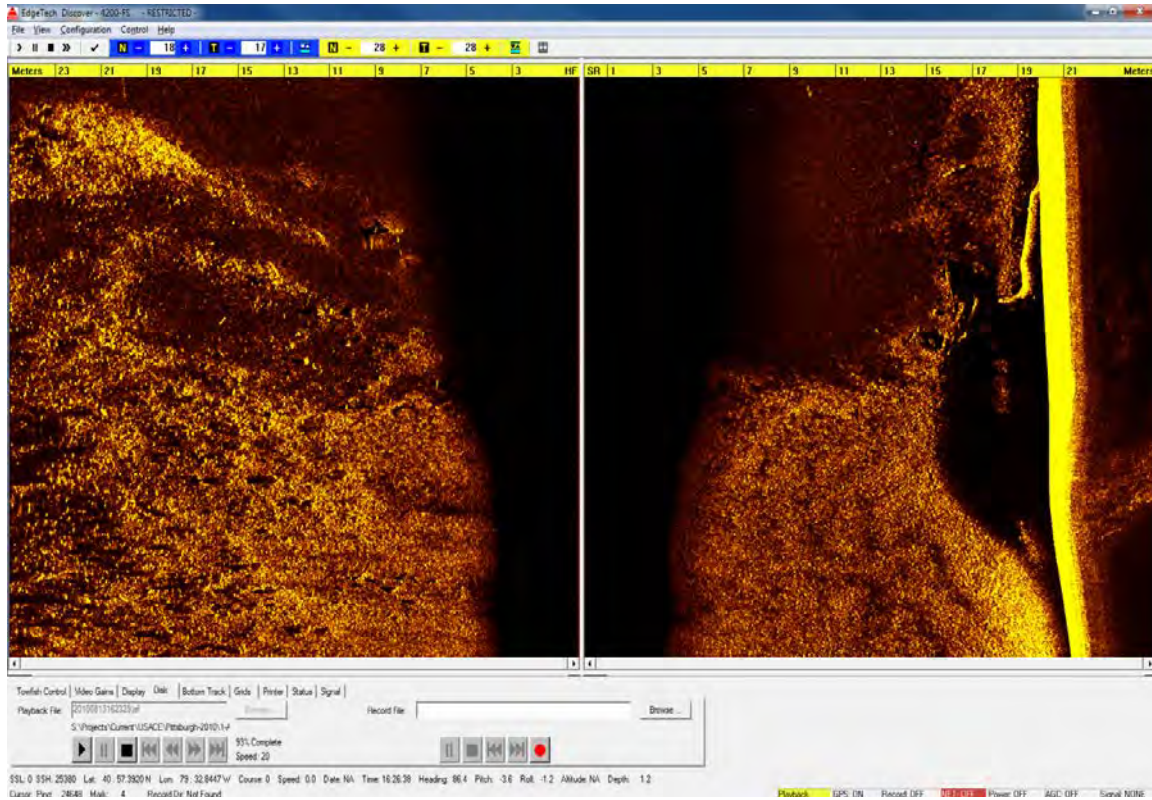

EM 1110-2-1003
30 Nov 13

AR LD 9 Below Power Plant

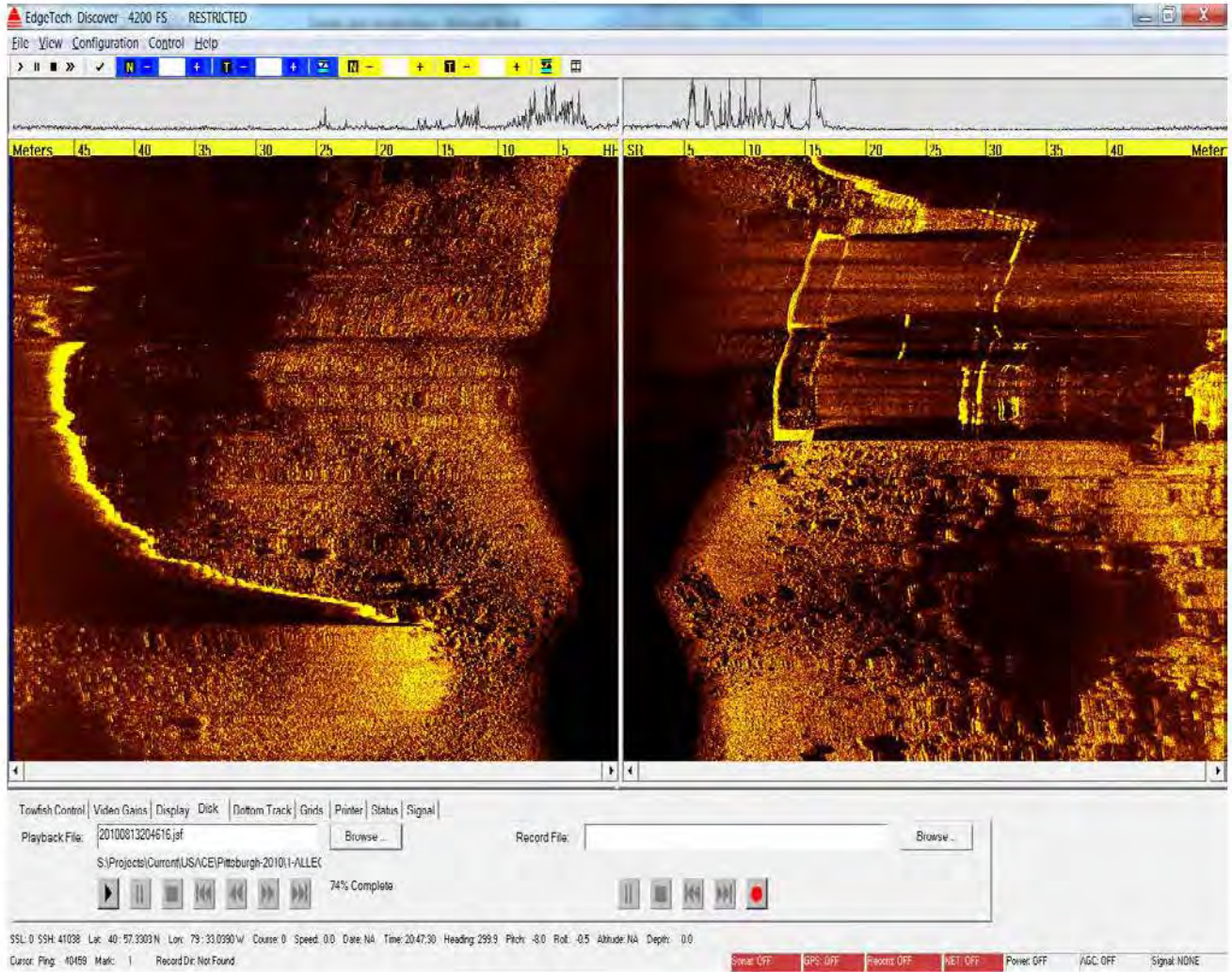

APPENDIX A

RESON SeaBat 8124 multibeam echo-sounder

APPENDIX B

**Applanix POSMV Wavemaster
GPS GNSS IMU**

APPENDIX C

RESON SVP14 (Sound Velocity Profiler)

APPENDIX D

EDGETECH 4125-P (High Resolution - Side Scan Sonar)

APPENDIX E

Topcon GR3

APPENDIX F

Scope of Work (SOW)

[NOTE: ALL APPENDICES TO THE SURVEY REPORT WERE WITHDRAWN FROM THIS APPENDIX]

EM 1110-2-1003
30 Nov 13

THIS PAGE INTENTIONALLY LEFT BLANK

APPENDIX N

Application Examples of Underwater Structural Investigation Surveys

N-1. This appendix contains examples of application projects provided by various inland districts. It is intended to illustrate the capabilities of these USACE districts in applying multibeam systems and related sensors to obtain detailed underwater (and above water) topography of locks, dams, bulkheads, and other structures. The indicated districts should be contacted for additional information on these applications.

N-2. Lock and Dam Multibeam Surveys. The following figures are examples of the resolution details available from multibeam surveys navigation lock approaches, approach wall pilings, gates, baffle blocks, and scour areas.

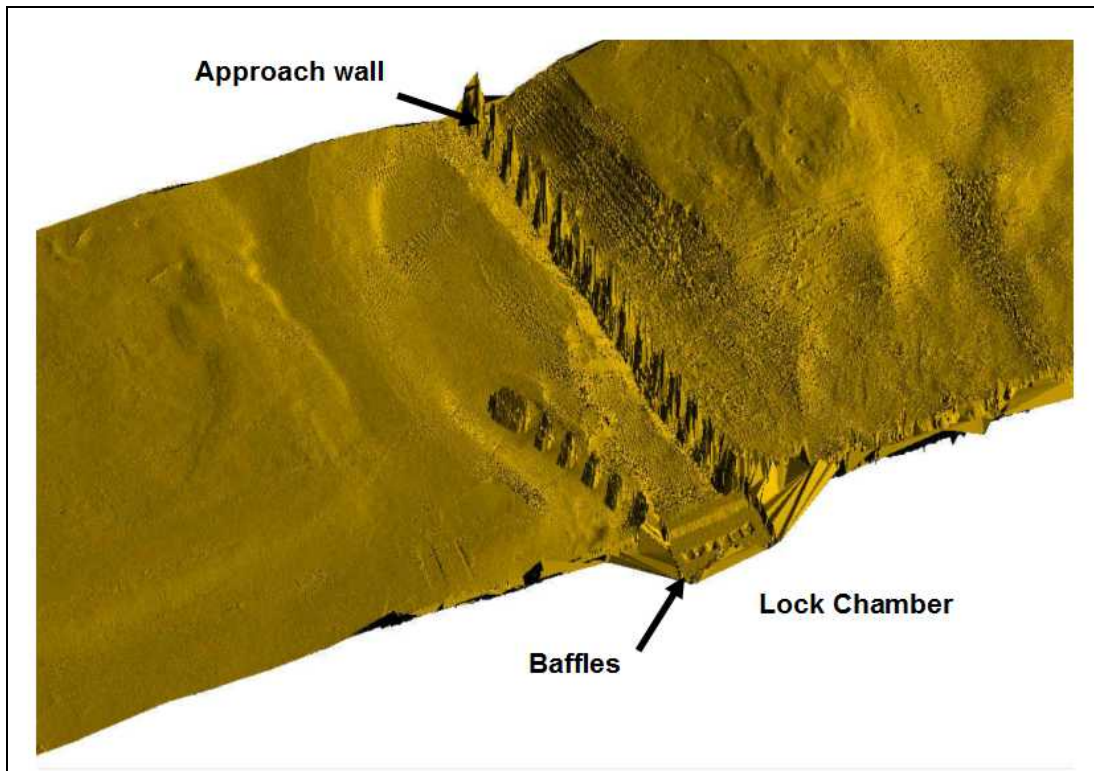

Figure N-1. Model from multibeam survey of approaches to Woodruff Lock and Dam, Apalachicola River, FL. (Mobile District--EMC, Inc)

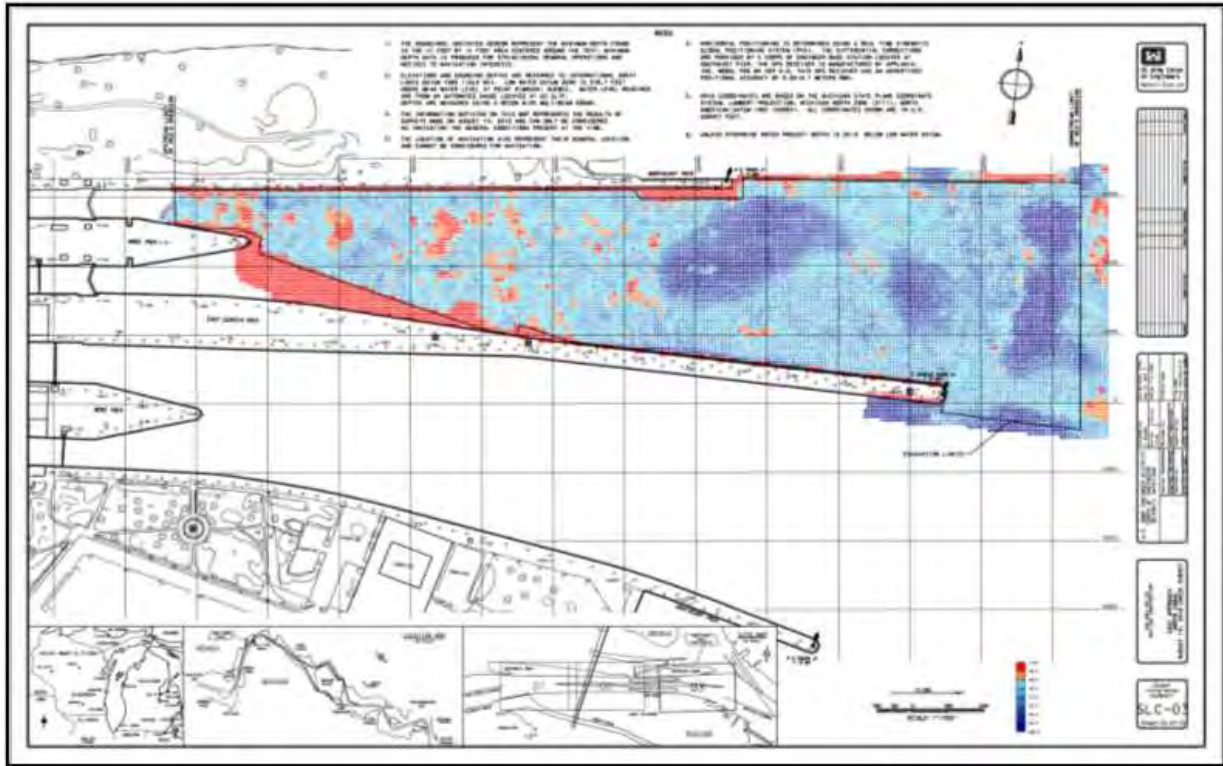

Figure N-2. Soo Locks East Approach Deepening Contract. Detailed multibeam survey by S/V Bufo, Soo Area Office. (Detroit District)

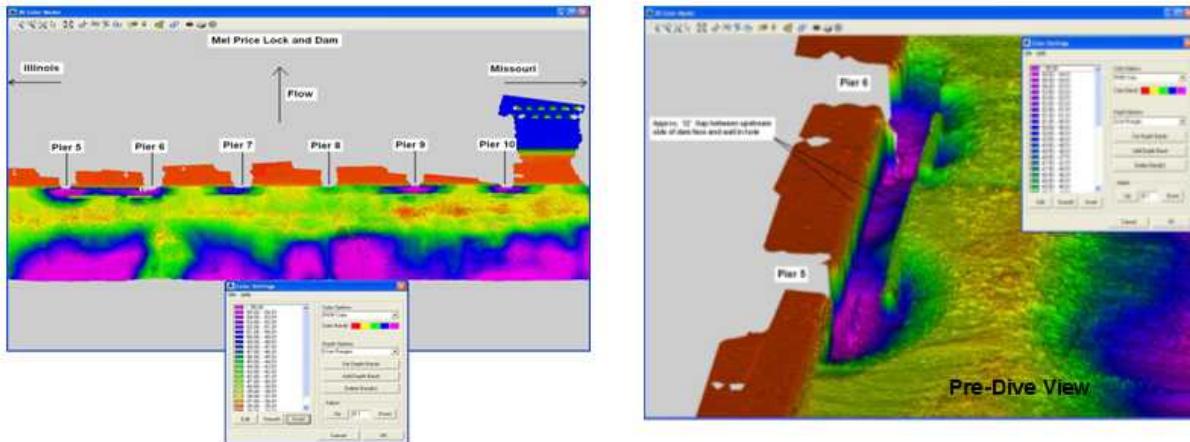

Figure N-3. On left, initial plan of multibeam survey at Mel Price Lock & Dam (Mississippi River). Significant scour (15 to 20 ft below normal grade) was indicated at piers 5, 6, 9, and 10). On right, 3D detail model of Pier 5 and 6 scour area furnished to divers. (St. Louis District)

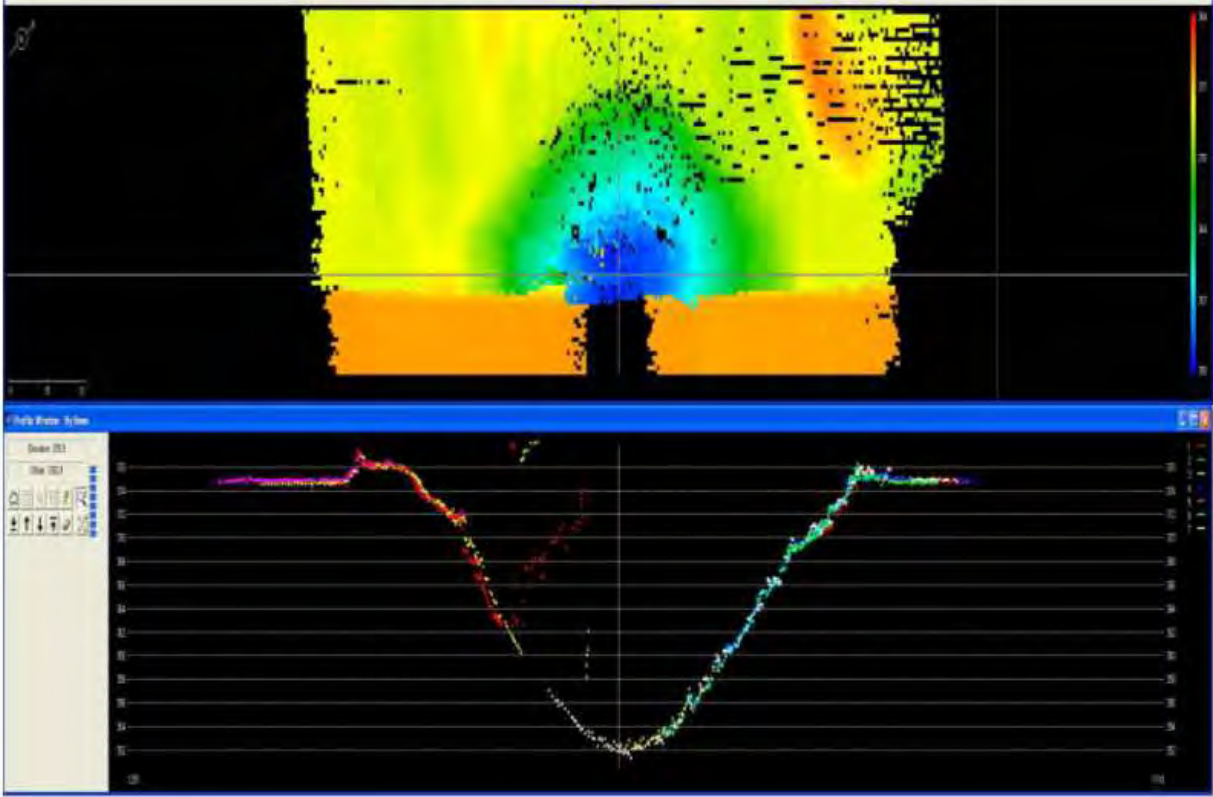

Figure N-4. Selected cross-section of the scour area in Figure N-3 used to estimate rock fill quantities. Mel Price Lock & Dam. (St. Louis District)

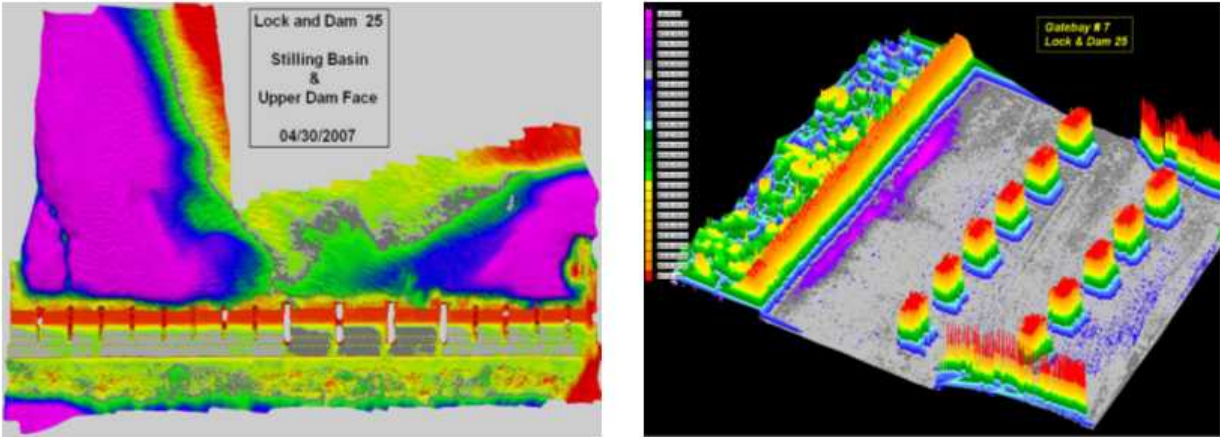

Figure N-5. Multibeam survey of Lock and Dam 25 (Mississippi River). Expanded 3D details showing a scour area and baffle blocks below gate 7. (St. Louis District)

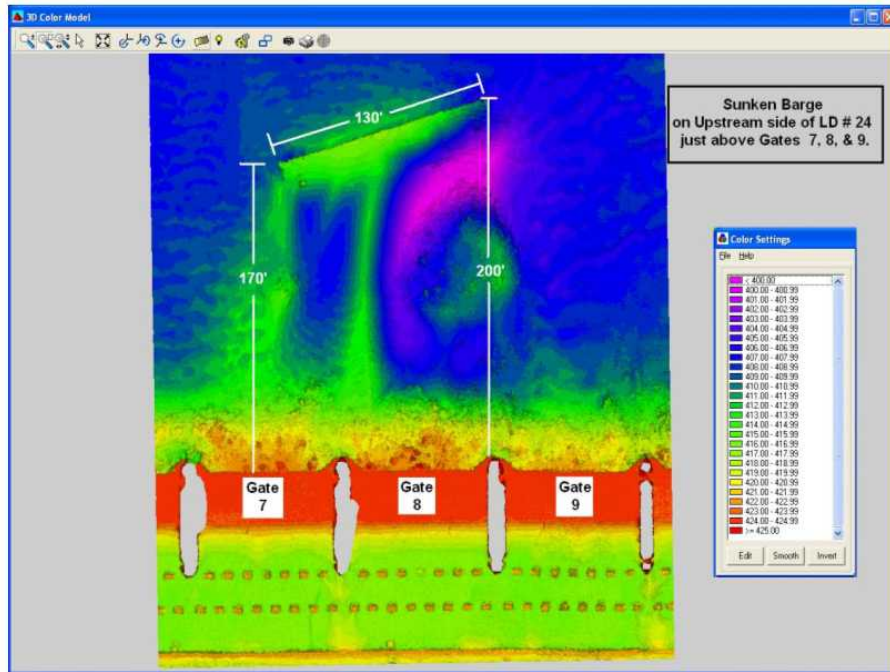

Figure N-6. Multibeam survey of sunken barge on upstream side of Lock & Dam 24, Mississippi River. (St. Louis District)

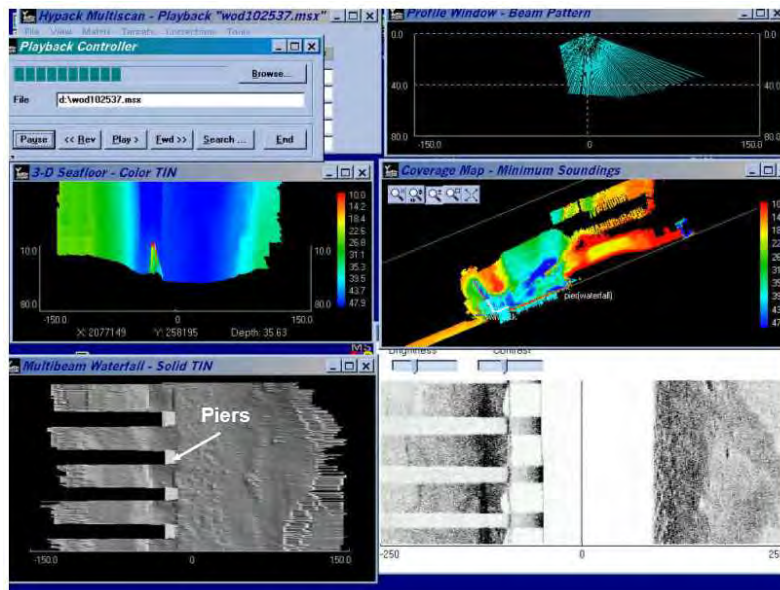

Figure N-7. Real-time multibeam screen displays of lock approach wall piers. Topographic model (lower left) and side scan sonar (lower right) depicts imagery between pilings. Woodruff Lock and Dam (Mobile District--EMC, Inc.)

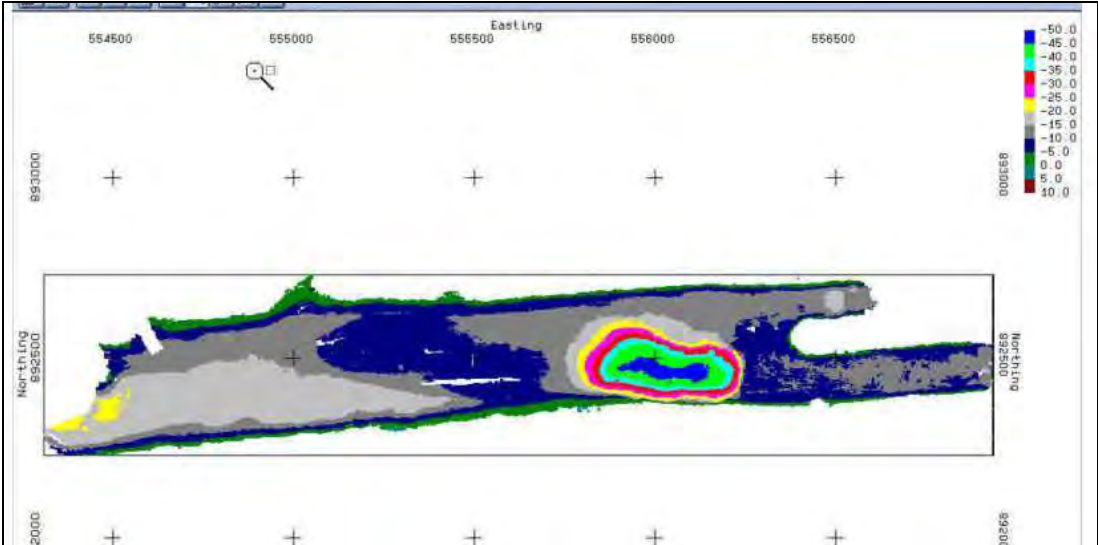

Figure N-8. Deep scour hole in vicinity of approaches to Ortona Lock, Okeechobee Waterway, Jacksonville District. (EMC, Inc.)

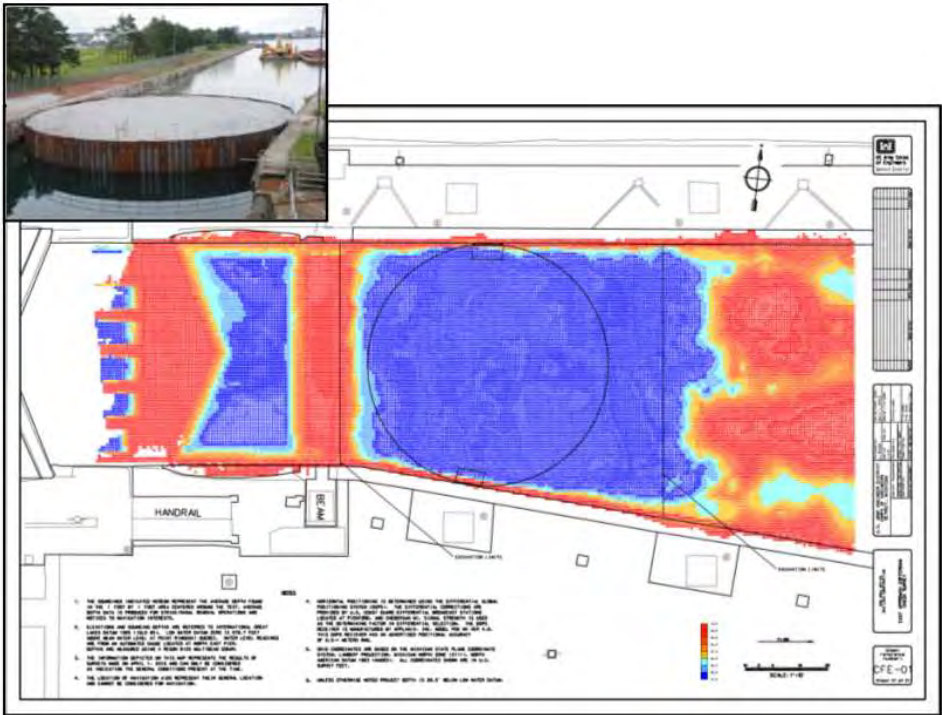

Figure N-9. New Soo Lock—Multibeam survey of cofferdam excavation. Soo Area Office. (Detroit District)

EM 1110-2-1003
30 Nov 13

N-2. Louisville District Surveys of Ohio River Lock and Dam 52. The following figures illustrate a Louisville District survey of Lock and Dam 52. The wicket gates at the lock generate extreme noise in the water, necessitating winter high waters to conduct scour investigation surveys, typically when the entire lock and dam complex is submerged under 8 ft of water.

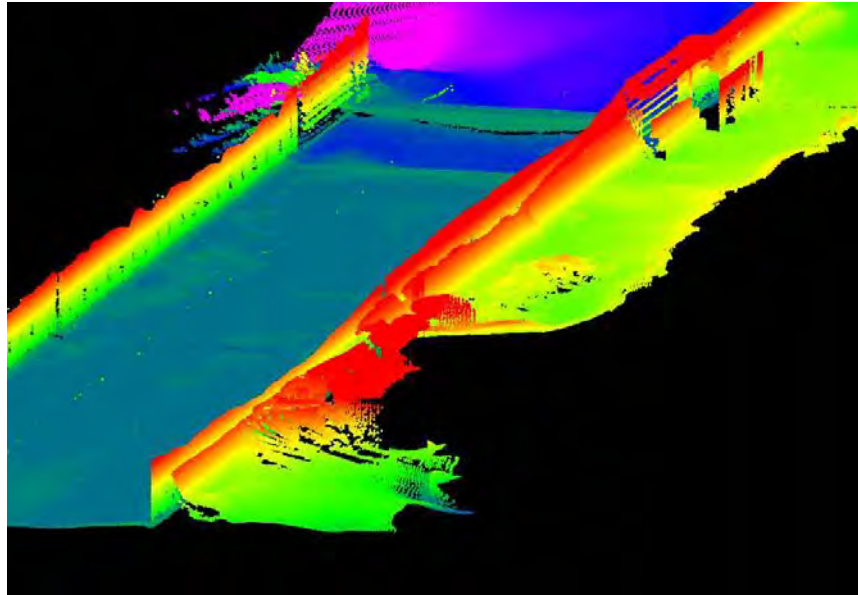

Figure N-10. Composite Reson 8125 multibeam survey of Ohio River Lock 52. (Louisville District)

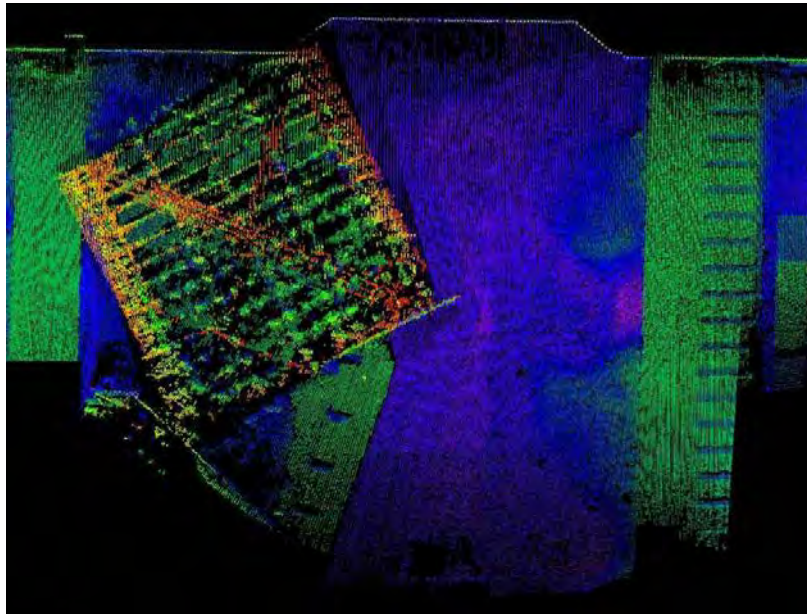

Figure N-11. Multibeam survey of Markland Lock Gate that broke free and fell into the lock sill. Detailed surveys allowed the district to determine the damage to the gate and if it could be safely removed without dewatering the chamber. (Louisville District)



Figure N-12. Louisville District 30-ft multibeam survey boat. This vessel is typical of those used for investigation surveys around Ohio River locks and dams. The Reson 8125 transducer is deployed through a moon pool in the hull.

N-3. Examples of a Navigation Chart Survey on the Ohio River. Figure N-13 is an example of typical navigation charting surveys by Louisville District. Depths are gridded by 250-x-250-ft bins. Color coded channel clearance levels clearly depict clear channel depths.

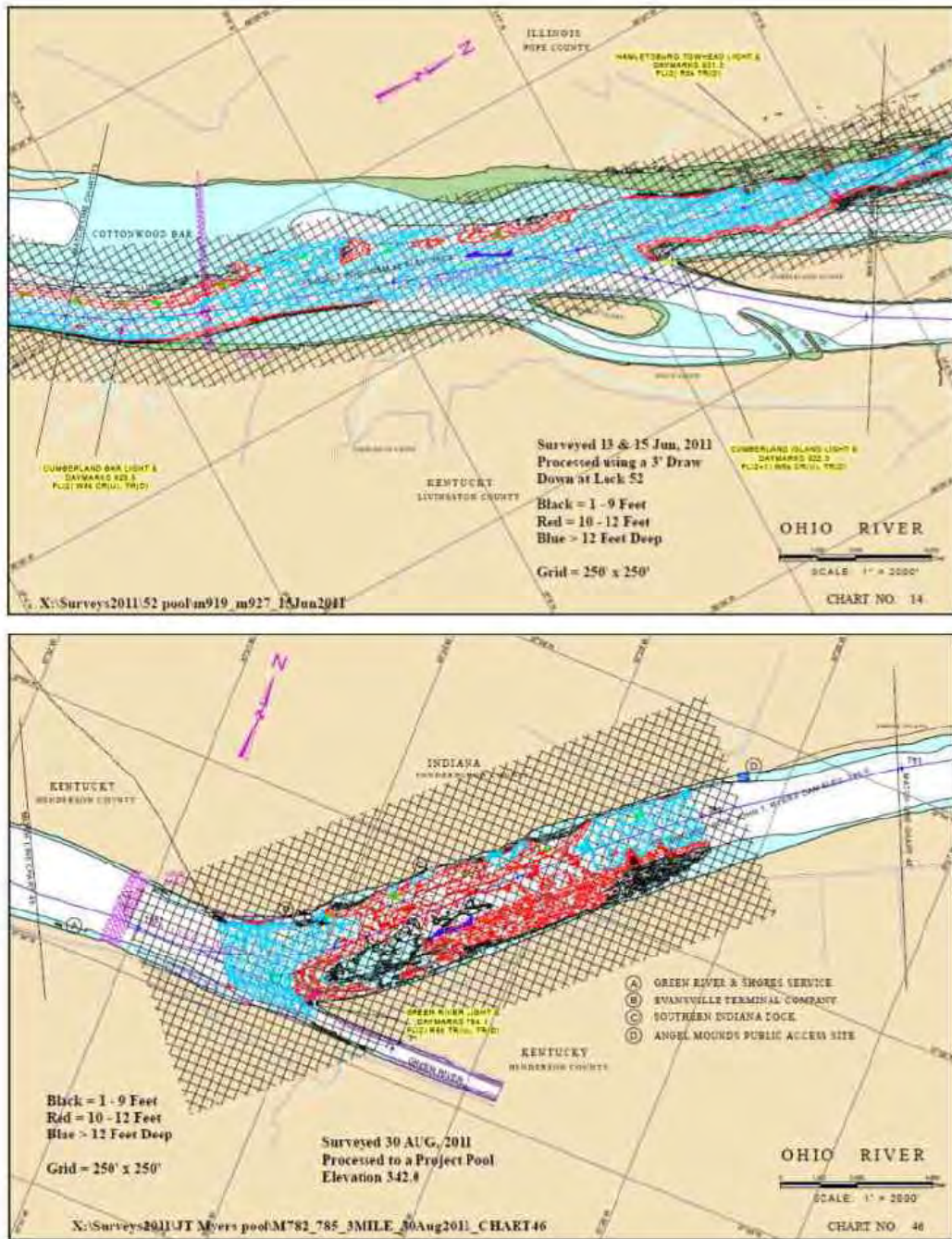

Figure N-13. Louisville District surveys of pools on the Ohio River. Depths below 12 ft are color-coded in red and black.

N-4. Additional Examples of Underwater Structure Investigation Surveys.

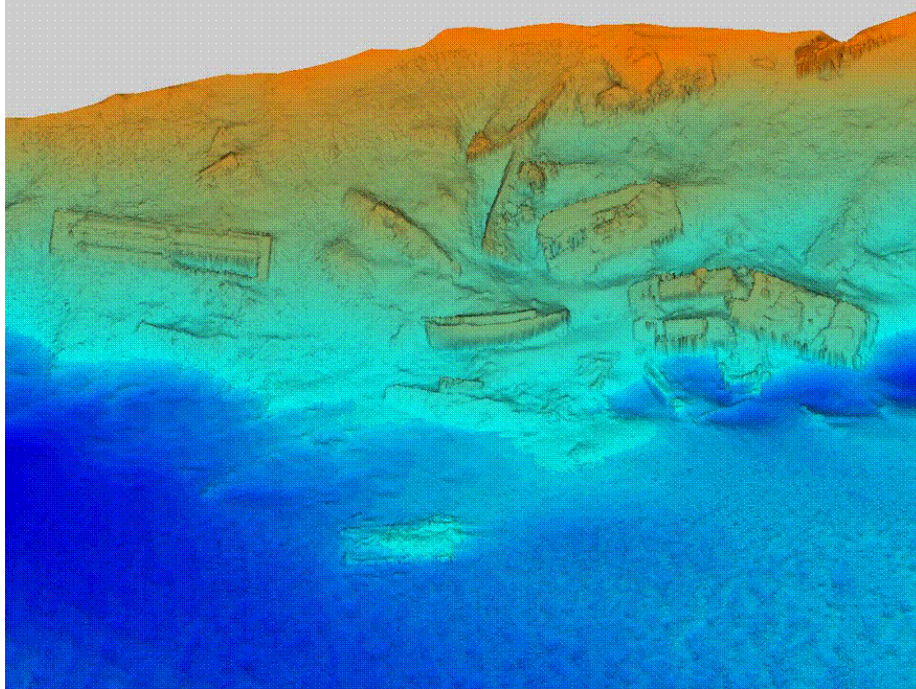

Figure N-14. Multibeam survey depicting sunken barges and other ship wrecks along a revetment bank on the lower Mississippi River. (New Orleans District)

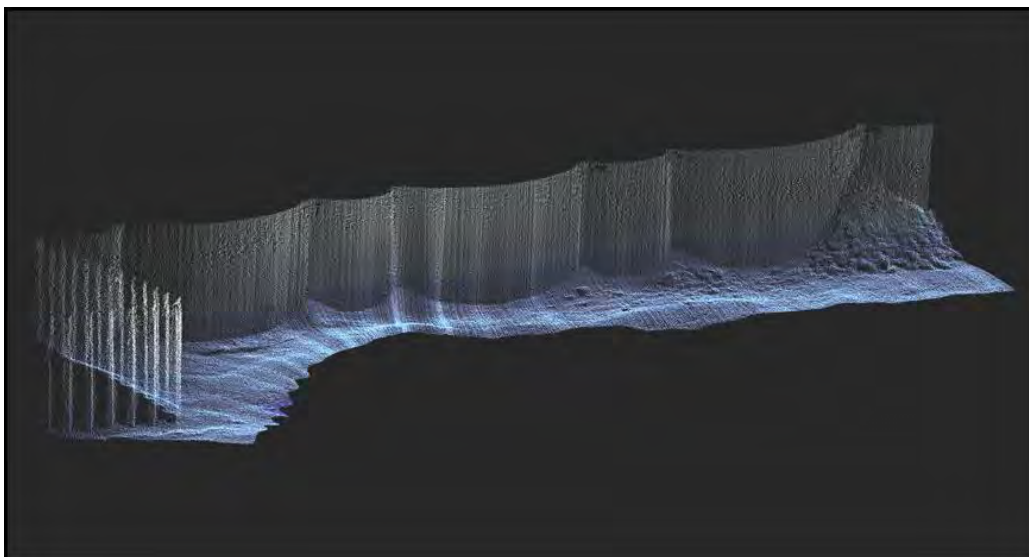

Figure N-15. Multibeam steel sheet pile inspection at Milwaukee Harbor CDF.
(Detroit District, Soo Area Office)

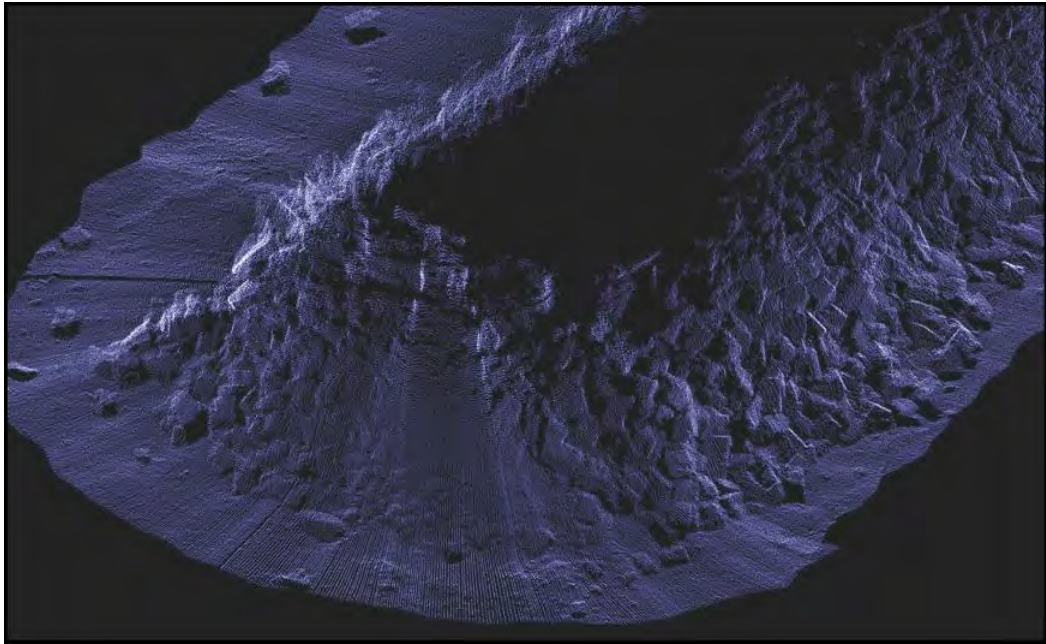

Figure N-16. Chicago Harbor multibeam breakwater inspection.
(Detroit District, Soo Area Office)

N-5. Multibeam Surveys at the Mississippi River Old River Control Structure. The New Orleans District developed a unique multibeam survey technique for assessing scour around the highly turbulent discharge areas around the Old River Control structure. The structure regulates the flow of water leaving the Mississippi into the Atchafalaya River. This system utilized a crane to deploy a heavily weighted multibeam transducer in the turbulent water at the Low Sill Structure.



Figure N-17. Old River Control Structures—surveys were performed at the Low Sill Structure. (New Orleans District)



Figure N-18. Weighted multibeam transducer with DGPS positioning (POS/MV).



Figure N-19. Multibeam transducer deployed from crane on Low Sill Structure.

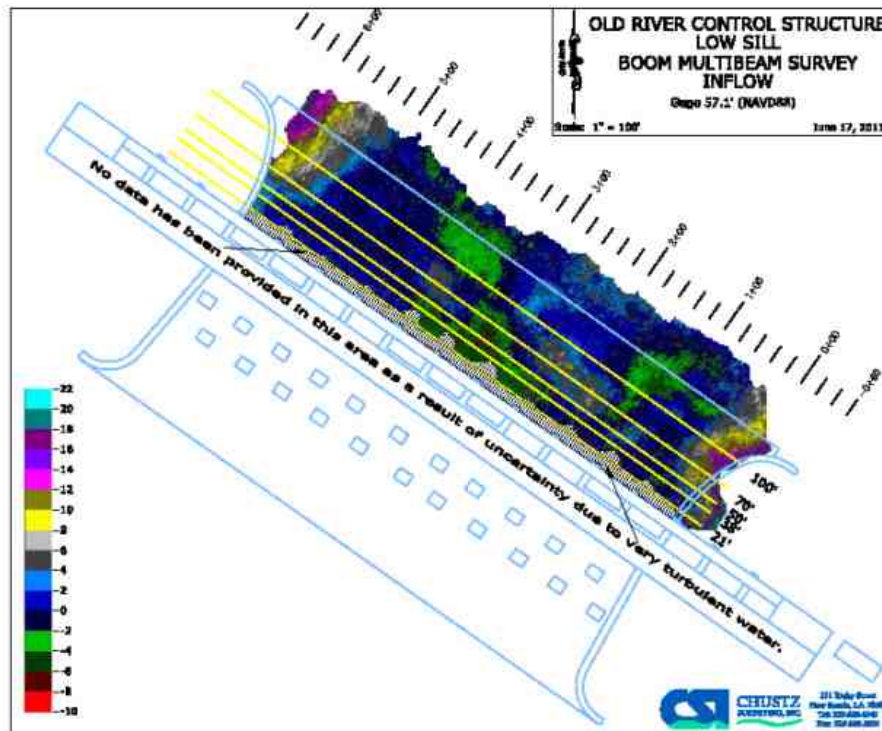

Figure N-20. Final plot of data along Low Sill Structure.

N-6. Marine-mounted Terrestrial LASER Scanning Systems. The following figure shows the resolution obtained from a terrestrial LIDAR scanning system on a lock and dam. This particular system (OPTECH LYNX) utilizes up to four LIDAR sensor heads. It fuses the LIDAR data with an on-board passive imaging system, a Trimble/Applanix POS/MV system, and an operational software platform to produce survey grade 3D data from a mobile vehicular platform.



Figure N-21. OPTECH LYNX marine mounted laser scan of Marmet Lock & Dam, Kanawha River, Huntington District. (Seaside Engineering and Surveying, Inc.)

EM 1110-2-1003
30 Nov 13

N-7. Merged Hydrography and Airborne LIDAR Data. Figures N-22 and N-23 are screen captures from projects done in 2009 by the Mobile District. They are a merge of hydro and overbank LIDAR, collected for sedimentation analysis and pool capacity calculations. The Alabama River LIDAR was collected by Tuck Mapping with their EagleEye sensor mounted aboard their helicopter. The hydro surveys were collected in-house by the Tuscaloosa Site Office using their multiple transducer sweep system.

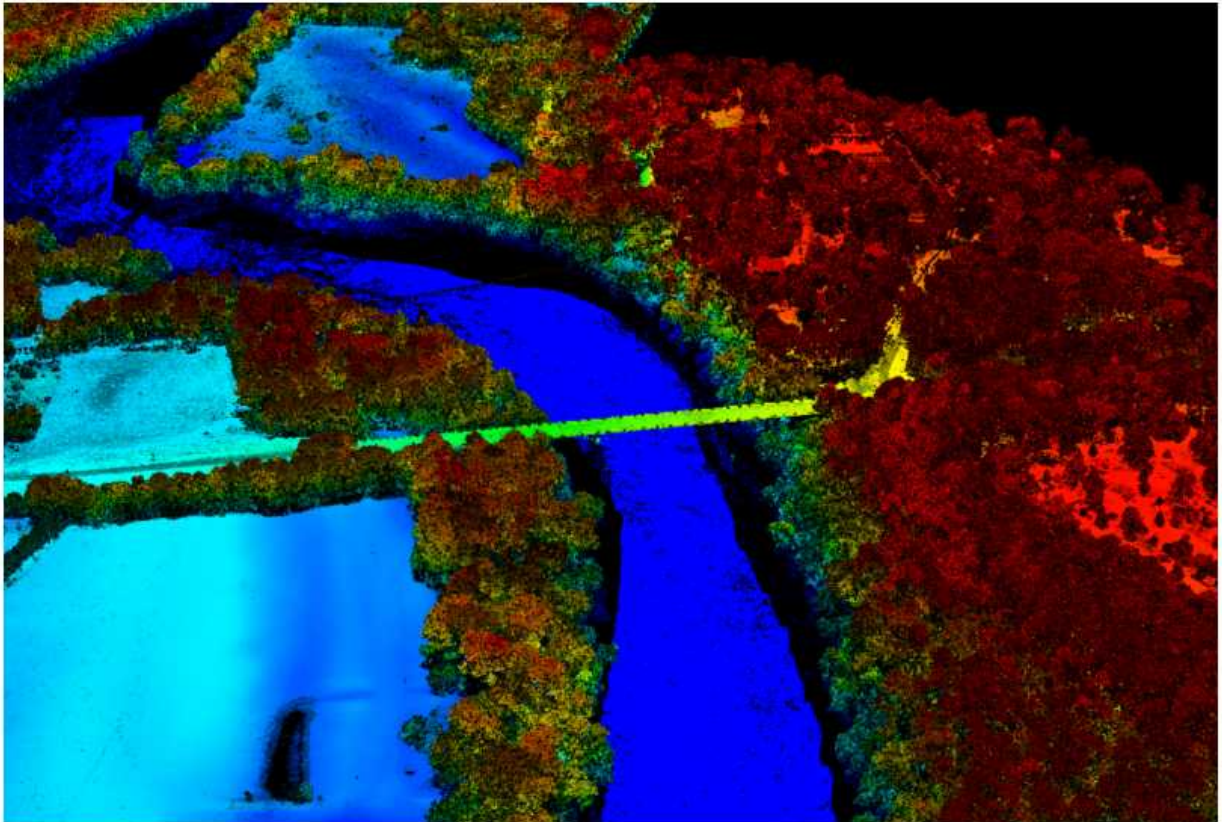

Figure N-22. George W. Andrews pool, Chattahoochee river, LIDAR and hydro point classes merged. LIDAR in LAS format, hydro in XYZ. Bridge is south of Walter F. George Lock and Dam, looking north. (Mobile District)

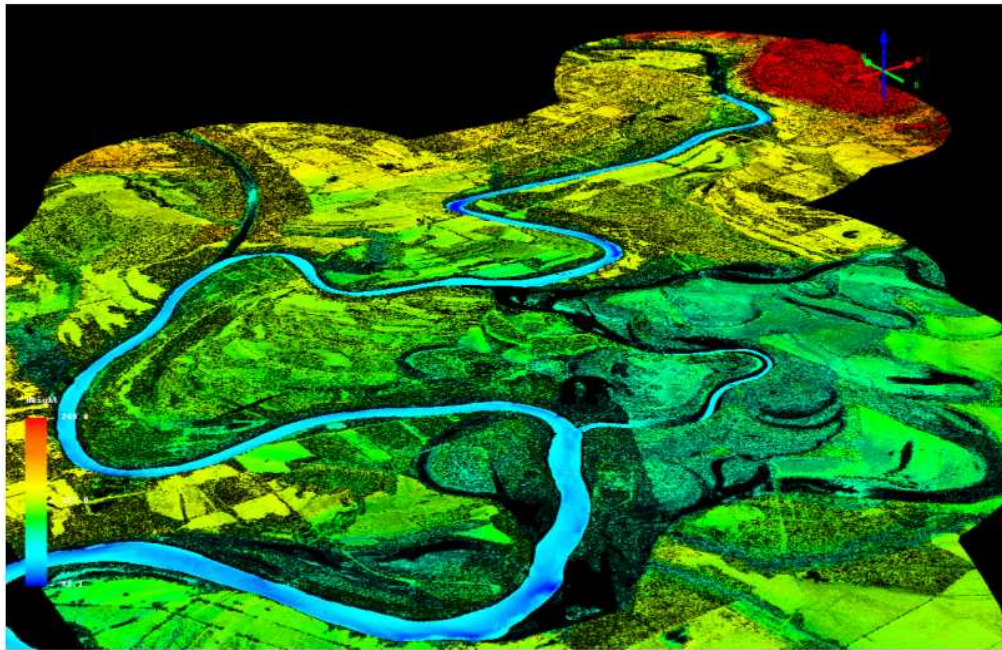

Figure N-23. R.F. Henry Pool, Alabama River. LIDAR and hydro merged datasets. Looking northeast, upstream. (Mobile District)

N-8. Biological and Bottom Classification Survey Applications. The figures below are examples of bottom classification and biological data collected in the Mississippi River by the St. Louis District Survey Vessel Boyer. Sensing systems included the DT 5000 120 kHz Dual Beam System for Locating Fish or Biomass (BioSonics), the DT 4000 200 kHz Dual Beam System for Identifying Bottom Classification (BioSonics), and the RoxAnn Seabed Identification Sonar to Identify Bed Material Types (Stenmar Sonavision).

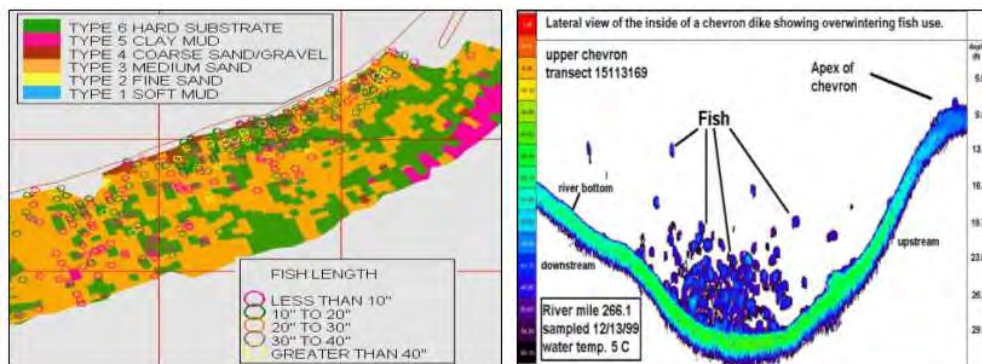

Figure N-24. Fish length and bottom material classifications. Chevron Dike, Mile 266, Mississippi River. (S/V Boyer, St. Louis District)

EM 1110-2-1003
30 Nov 13

N-9. Carr Creek Dam, Kentucky (Louisville District). Figure N-25 depicts a multibeam survey of the pool above Carr Creek Dam.

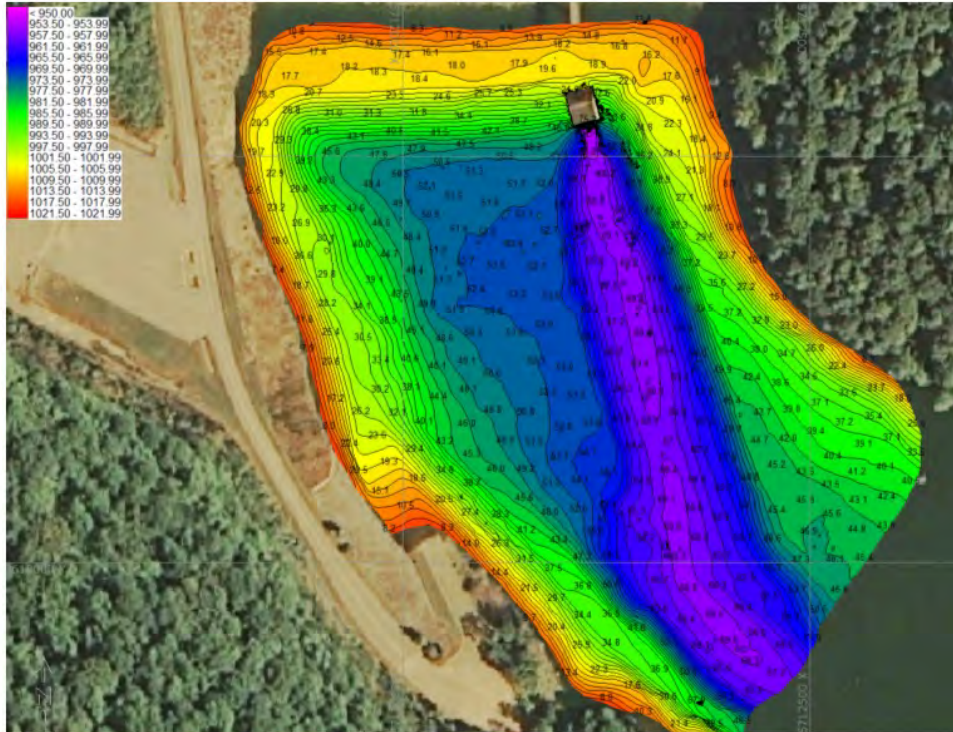

Figure N-25. Carr Creek Dam survey – 28 Aug 12. (Louisville District).

N-10. Example Bridge Clearance Surveys (Louisville District).

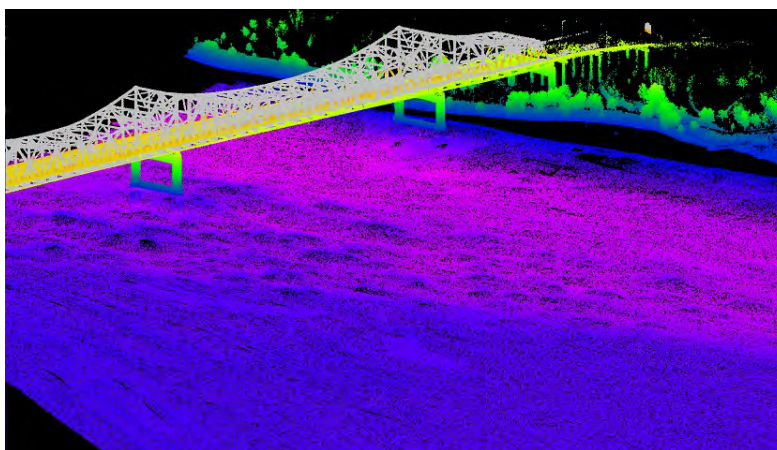

Figure N-26. Merged Multibeam and LIDAR data – Ohio River. (Louisville District)

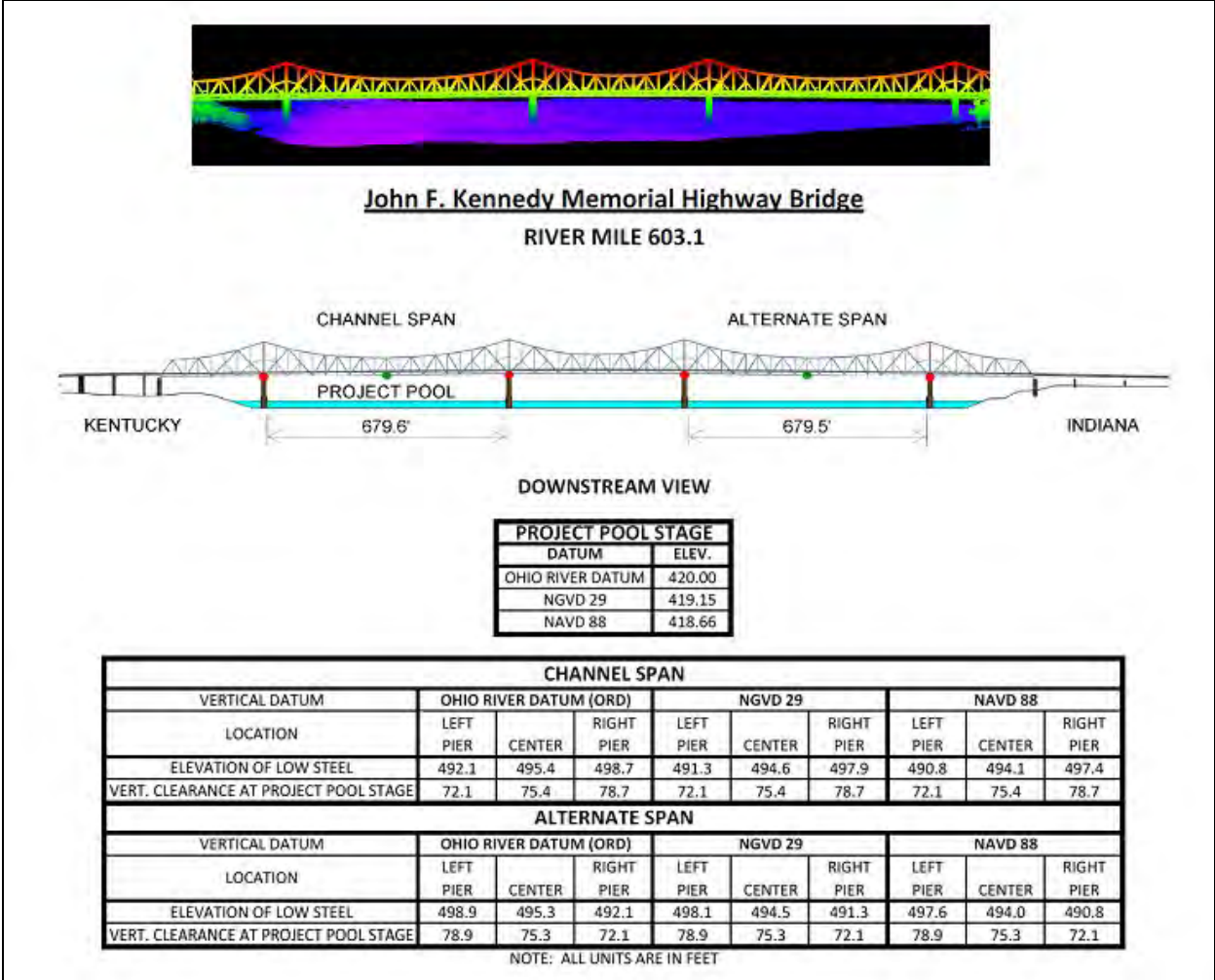

Figure N-27. LIDAR Scan used to Produce Bridge Clearances.
 (John F. Kennedy Memorial Bridge, Ohio River Mile 603.1 at Louisville, KY)

EM 1110-2-1003
30 Nov 13

THIS PAGE INTENTIONALLY LEFT BLANK

APPENDIX O

Howard Hanson Dam Monitoring

December 2009 Survey – Approximate Pool Elevation 1074'

Hydrographic and Terrestrial Survey Report

Contract No. W912DW-09-D-1015, Task Order No. 0009

December 2009



Color Coded Elevation Difference Image (Dec 09 to March 09 Baseline)

Owner:

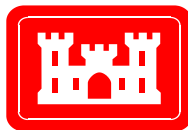

**U.S. Army Corps of Engineers
Seattle District**

Prepared by:



David Evans and Associates, Inc.
2801 SE Columbia Way, Suite 130
Vancouver, WA 98661
(360) 314-3200

EM 1110-2-1003
30 Nov 13

Howard Hanson Dam Monitoring

December 2009 Survey - Approximate Pool Elevation 1074'

Hydrographic and Terrestrial Survey Report

Contract No. W912DW-09-D-1015, Task Order No. 0009

December 2009

Prepared by:

Nicholas S. Lesnikowski
David Evans and Associates, Inc.
Senior Associate
Lead Hydrographer
ACSM Hydrographer #206

Mark Kimborowicz, P.L.S.
David Evans and Associates, Inc.
Senior Associate
WA PLS 38962

Reviewed by:

Jon Warren, PLS
David Evans and Associates, Inc.
Senior Associate
Regional Survey Manager
WA PLS 21599

TABLE OF CONTENTS

	<u>Page</u>
1.0 INTRODUCTION.....	5
2.0 DATUMS AND PROJECT CONTROL	5
2.1 POSITIONING ACCURACY VERIFICATION	6
3.0 BATHYMETRIC SURVEY METHODOLOGY	6
3.1 SURVEY COVERAGE	6
3.2 SURVEY VESSEL AND CREW	7
3.3 POSITIONING AND NAVIGATION	7
3.4 WATER SURFACE OBSERVATIONS.....	7
3.5 MULTIBEAM DATA ACQUISITION	8
3.6 MOBILE LASER SCAN DATA ACQUISITION	9
4.0 MARINE EQUIPMENT CALIBRATION	9
4.1 CALIBRATION TESTS.....	9
4.2 MULTIBEAM SONAR BAR CHECK	10
4.3 SOUND VELOCITY	10
5.0 MARINE DATA PROCESSING.....	10
5.1 MARINE SURVEY ACCURACY	11
6.0 UPLAND SURVEY METHODOLOGY	11
6.1 SURVEY COVERAGE	11
6.2 SURVEY CREW AND EQUIPMENT	12
6.3 SURVEY CONTROL	12
6.4 HIGH-DEFINITION LASER SCANNING	12
6.5 CONVENTIONAL CROSS-SECTIONS.....	13
6.6 UPLAND SURVEY ACCURACY	14
7.0 DATA EXPORT AND MERGING WITH UPLAND DATA.....	14
7.1 DATA INTERPRETATION	15
7.2 DELIVERABLES	15

List of Tables

Table 1: Control Coordinates.....	5
Table 2: RTK GNSS Observation vs. Provided Position - Point 2202	6
Table 3: Water Elevation Checks	8
Table 4: Correctors Applied to Sensor Data	9

Table 5: Marine Laser Scan Data vs. Control Point Targets 11
Table 6: Cross-Section Observations Results 13

List of Figures

Figure 1: Conventional cross-sections..... 13

Appendices

- Appendix 1: List of Survey Control
- Appendix 2: Survey Notes and Logs

Acronyms and Abbreviations

ACSM	American Congress on Surveying and Mapping
ASCII	American Standard Code for Information Interchange
DEA	David Evans and Associates, Inc.
DGN	MicroStation drawing file
DTM	Digital Terrain Model
DXF	Data eXchange Format
GLONASS	Russia’s Global Orbiting Navigation Satellite System
GNSS	Global Navigation Satellite System
GPS	Global Positioning System
GRS-80	Geodetic Reference System of 1980
HIPS	Hydrographic Information Processing System
Hz	Hertz
IAKAR	Inertial-Aided Kinematic Ambiguity Resolution
IMU	Inertial Measurement Unit
kHz	kilo Hertz
LN	Line Number
M	Meter
NAD 27	North American Datum of 1927
NAD 83	North American Datum of 1983
NAVD 88	North American Vertical Datum of 1988
NGVD 29	National Geodetic Vertical Datum of 1929
OTF	On-the-fly
PDF	Portable Document Format
POS/MV	Position and Orientation System for Marine Vessels
RTK	Real-Time Kinematic
SPCS	State Plane Coordinate System
TIFF	Tagged Image File Format
USACE	United States Army Corps of Engineers

INTRODUCTION

In December, March and April of 2009, David Evans and Associates, Inc. (DEA) conducted precision upland control and laser scanning surveys in conjunction with multibeam bathymetric surveys of the Howard Hanson Dam near Enumclaw, Washington. The primary goal of the surveys was to develop accurate elevation data of the dam and surrounding areas as part of a periodic monitoring program. For this monitoring survey, hydrographic survey operations were conducted on December 3rd while upland survey work was conducted between March 24th and April 16th, 2009. This report describes the control used for the surveys, data acquisition methodology, and data processing procedures. In addition to this report, deliverables include a project CD-ROM containing ASCII (American Standard Code for Information Interchange) XYZ gridded point data and an updated “post-construction” contour map in DGN format.

1.0 DATUMS AND PROJECT CONTROL

Conducting a survey on an established coordinate system, referenced by monuments, enables the survey to be reproduced at a later date with repeatable results. For this survey, hydrographic field operations were conducted on NAD83 (CORS96 Epoch2002)/NAVD88 datums, and final data sets generated, using the North American Datum of 1927 (NAD27) horizontal datum projected to the State Plane Coordinate System (SPCS), Washington North Zone with units in U.S. Survey Feet. Vertical datum for this survey is the National Geodetic Vertical Datum of 1929 (NGVD29).

Positioning and vertical control for the marine based survey were provided by a combined inertial and real-time kinematic (RTK) global navigation satellite system (GNSS) with vertical observations based on NAVD88 elevations. GNSS receivers were used during this survey to track not only the global positioning system (GPS) satellites, but also the GLONASS satellites to provide better accuracy in the heavily obstructed areas around the dam structures due to the low pool level. An RTK GNSS base station was deployed on monument 2200 which had been established by DEA for the USACE (United States Army Corps of Engineers) under an earlier contract. Table 1 presents coordinates and elevations for monuments used during the hydrographic survey. A complete listing of project control is located in Appendix 1.

Table 1: Control Coordinates

Monument Designation	NAD83 WA North		NAD27 WA North		NGVD29	WGS84
	<i>North M</i>	<i>East M</i>	<i>North US Ft.</i>	<i>East US Ft.</i>	<i>Elev. Ft.</i>	<i>Ellipsoid Ht. M</i>
2200	31085.118	427889.874	102044.617	1763714.473	1229.962	354.844
2202	31188.069	427774.936	102382.384	1763337.380	1201.535	346.172
69001	31289.759	427926.337	102716.01	1763834.098	1106.606	317.244
69002	31326.877	427997.029	102837.788	1764066.027	1094.848	313.662
69003	31355.508	428070.295	102931.722	1764306.399	1089.915	312.161

Performance of the RTK GNSS was improved by using Geodetic Reference System of 1980 (GRS-80) values as the reference for the RTK GNSS base station. Coordinates of the control monuments used for the RTK GNSS base station were converted to GRS-80 geographic coordinates and GRS-80 ellipsoid heights. CorpsCon version 6.0.1 software, using NADCON lookup tables, was used for the horizontal position conversion. An ellipsoid separation model, based on GEOID03, was utilized for on-the-fly conversion from the GRS-80 ellipsoid heights (ellipsoid from which GNSS heights are derived for NAD83) to NAVD88 elevations.

2.1 Positioning Accuracy Verification

The survey included a horizontal and vertical position check using RTK GNSS techniques on “2202” before the survey on December 3rd, 2009. Table 2 presents the differences obtained from RTK GNSS observations to the converted provided position for “2202”. All hydrographic data was recorded in meters during survey operations and adjusted to project datum and units during post-processing.

Table 2: RTK GNSS Observation vs. Provided Position - Point 2202

<i>Direction</i>	<i>Diff. Meters</i>	<i>Diff. Feet</i>
Northing	0.028 m	0.09 ft
Easting	-0.005 m	-0.02 ft
Elevation	0.002 m	0.01 ft

2.0 BATHYMETRIC SURVEY METHODOLOGY

3.1 Survey Coverage

Complete multibeam and laser scan data coverage was attained within the area defined by the project specifications across the 1,500-foot wide forebay of the dam. During this monitoring survey, the pool elevation was very low (approximately 1074' NGVD29), leading to very shallow depths for the vessel to navigate. This also increased the blockage of the satellite signals in the areas close to the intake structure and dam face. Care was taken in these areas to ensure they were surveyed at the best possible time using the predicted constellation and Trimble's planning software. Multibeam coverage was limited to areas safely navigable by the vessel, and was not significantly impacted in any areas apart from the northeast corner of the dam near the creek run-off. Here, a small gap exists between the multibeam and laser scan data as the vessel could not get as close to the shoreline.

The mobile laser scan data was acquired along the lower exposed section of the dam from the water level at the time of the survey up to a distance of approximately 150 feet up slope from the

edge of water (approx 1150' NGVD29). This provided considerable overlap with the terrestrial laser scan data for comparison.

3.2 Survey Vessel and Crew

The vessel for this survey was the *Motion Marine*, a 21-foot custom survey boat operated by DEA. The vessel is equipped with an integrated navigation and data acquisition system, a custom mount for the SeaBat 8101 sonar head and Riegl z390i laser scanner, and is ideal for shallow water survey operations in tight quarters. The hydrographic survey crew consisted of a senior hydrographer and vessel operator/hydrographer from DEA. The crew has conducted numerous multibeam and side scan sonar surveys and has had extensive training in hydrographic surveys.

3.3 Positioning and Navigation

Horizontal positions were acquired with an Applanix POS/MV combined inertial and RTK GPS navigation system. The POS/MV system integrates two GNSS receivers with an inertial measurement unit (IMU), although only GPS measurements are used in the real-time solution. This system not only provides motion information (heading, roll, pitch, and heave) to compute X, Y, Z data from the multibeam sonar measurements; it also provides accurate inertial navigation through GPS outages for up to 30 seconds. The GPS/inertial positioning system enabled the survey vessel to run near the intake structure without jeopardizing positioning integrity from satellite signal loss or multipath.

Position data was used in real-time to provide navigation information to the vessel operator and was time tagged and logged with multibeam and other ancillary data. The actual survey tracks are displayed with multibeam swath coverage in real-time on a monitor located at the helm to aid in a systematic survey of the area.

The POS/MV system was configured to not only output real time positions and attitude, but also log raw GNSS and IMU data to a separate file for post processing.

3.4 Water Surface Observations

As all bathymetric data is time tagged and recorded relative to the water surface, accurate water surface observations in the vicinity of the survey are required to account for water level changes. Water surface measurements were obtained in real-time by RTK GNSS with on-the-fly (OTF) ambiguity resolution using a Trimble SPS881 RTK GNSS receiver. An RTK GNSS base station was deployed to provide RTK GNSS correctors to the rover GNSS receiver aboard the survey vessel. RTK correctors were applied to the shipboard GNSS for logging of water surface elevations at a rate of one hertz (Hz). The GEOID03 ellipsoid separation model (g2003u01) was used in Hypack MAX software for OTF conversion from the GRS-80 ellipsoid (ellipsoid from

which GNSS heights are derived) to NAVD88 vertical datum. RTK GNSS water level observations were used as a real time quality check during survey operations and enabled comparison with Howard Hanson Dam tide board readings and digital data provided by the USACE. A summary of these comparisons is shown in Table 3 along with the difference between USACE digital water level readings and RTK GNSS water level values.

Table 3: Water Elevation Checks

Date & Time (Local)	12/03/09 11:40	12/03/09 15:00
USACE Readings	1074.06*	1073.82
RTK GNSS	1073.88	1073.68
Tide Board Reading	1074.0	1073.8
Difference (USACE – RTK GNSS)	0.18 ft	0.14 ft

** elevation interpolated from 11:00 1074.15' and 12:00 1074.01'.*

3.5 Multibeam Data Acquisition

Soundings were acquired with a Reson SeaBat 8101 multibeam bathymetric sonar using a frequency of 240 kilo-hertz (kHz). The system records 101 soundings in a single sonar ping. Additionally, DEA's 8101 includes options such as a stick projector for enhanced shallow water performance and the ability to output side scan sonar imagery. The stick projector option on the Reson SeaBat 8101 improves the system performance in shallow water (depths less than 150 feet).

Multibeam data was conducted in the forebay by running lines parallel with the back of the dam for the length of the project. For this survey, the sonar head was mounted with a 15° starboard angle offset to allow for maximum coverage of the dam structure and shoreline. This enabled coverage from nadir (straight down) 90° to starboard (horizontal) and from nadir out to 60° to port with a recorded depth every 1.5°. Sonar swaths were recorded at a rate of 15 Hz as the vessel transited along the survey track lines. Running with a 110° swath (55° to port and starboard), the system provided nearly three times the water depth coverage in a single pass. The total swath width of full coverage mapping in a single pass varied with the water depth. Survey lines closest to shore were run with the starboard side facing the shore and the starboard swath was opened to 90° to maximize sonar coverage up the abutment.

The most vital measurements in a multibeam survey are heading and attitude angles. To account for vessel heading, heave (vertical movement), pitch and roll, an Applanix POS/MV motion reference sensor was utilized. By utilizing vessel speed over ground and heading data provided by GPS, the POS/MV can isolate horizontal accelerations from vessel turns and provide highly accurate motion data. The POS/MV system was also used to record vessel heading (yaw) from

which the sonar beam orientation was derived. The POS/MV provides a higher degree of accuracy for heading measurements than a conventional gyrocompass.

The navigation and survey control system was a personal computer running Hypack MAX version 2008 software. Both Hypack's Hysweep software and Triton Imaging's ISIS software were used for multibeam and sensor data acquisition. Hypack software allowed the swath bathymetric data to be displayed as a painted color image on the navigation screen. This real-time display gave the hydrographers immediate indications of data quality and coverage. Data collected in ISIS was used for processing and final deliverables.

3.6 Mobile Laser Scan Data Acquisition

Mobile laser scan data was acquired with a Riegl z390i. In the vessel mounted configuration, it is set-up as a 2-dimensional scanner. It measures range and angle to determine points in a linear swath that is 80° (40° each side of horizontal). The instrument uses an electro-optical pulsed time-of-flight measurement of short infrared laser pulses to determine range, coupled with a rotating multi faceted mirror to provide fully linear, unidirectional scan lines. During this survey, the system was configured to collect approximately 10 scans per second with 801 points in a single scan.

The same principles of position and attitude measurement used with the multibeam bathymetry apply to the laser data. All data was collected in Hypack's Hysweep software for both navigation and final processing.

4.0 MARINE EQUIPMENT CALIBRATION

4.1 Calibration Tests

Calibration tests were conducted to confirm alignment of the survey sensors with the POS/MV and verify delay times applied to the time-tagged sensor data. This consisted of a series of lines run in a specific pattern, which were used in pairs to analyze roll, pitch, and heading alignment angles for the multibeam echosounder and for the vessel mounted laser, as well as latency (time delays) in the time tagging of the sensor data. Table 4 lists the applied correctors for sensor bias determined through analysis of the patch test data.

Table 4: Correctors Applied to Sensor Data

<i>Point</i>	<i>Position Timing (seconds)</i>	<i>Pitch (degrees)</i>	<i>Roll (degrees)</i>	<i>Yaw (degrees)</i>
Reson 8101 Multibeam Sonar	0.00	0.00	-0.75	0.00
Riegl LMS Z360i Mobile Laser	0.00	-0.30	0.55	0.52

4.2 Multibeam Sonar Bar Check

To confirm the draft of the sonar head, a bar check was performed by lowering a flat plate to a known distance from the water surface and placing it under the sonar head. The recorded sound velocity corrected sonar depth is then compared to the known depth of the bar check device. The bar check performed at Howard Hanson Dam showed agreement within 0.03 feet of measured values to the known depth.

4.3 Sound Velocity

Detailed measurements of the sound velocity profile through the water column are crucial in multibeam surveys. Changes in the velocity profile will not only affect acoustic distance measurements, but can also cause refraction or bending of the sonar path as it passes through layers in the water column with different velocities. An Applied Microsystems AML SV Plus V2 was used to measure the speed of sound of the water column and the depth at which the sound velocity was measured.

5.0 MARINE DATA PROCESSING

Processing of multibeam sonar and vessel mounted laser data was conducted utilizing Caris HIPS hydrographic information processing system software. Patch test data were analyzed and alignment corrections for both survey sensors were calculated and applied during processing. In addition, the real time navigation solution was overwritten with a post processed Inertial-Aided Kinematic Ambiguity Resolution (IAKAR) solution which included updated heading, attitude and navigation measurements.

The IAKAR solution was computed using Applanix POSPac MMS 5.2 software to post processes the raw navigation solution using a single base station as a reference. In addition to broadcasting RTK correctors the GNSS base station also logged 1 second epoch GNSS observables which were incorporated in the IAKAR post processing of the POS MV navigation solution.

Final GNSS water levels were computed by editing the real-time data for flyers and averaging the results to remove the effects of short-period vessel heave. A 30-second moving average was applied in Hypack MAX software and the averaged water level values were exported with a time stamp every second for import into Caris HIPS. The GNSS water levels were relative to NAVD88 and account for the distance between the GNSS antenna phase center and the measured location of the waterline along the vessel's hull. All measurements for this survey were reduced to NGVD29 elevations in the delivered data set.

Velocity profiles measured in the field were converted to Caris format then used to correct multibeam sonar slant range measurements and compensate for any ray path bending.

Data cleaning began with review of each survey line using the Caris HIPS swath editor. Verified water surface correctors were applied to the data set at this time. Position and sensor data were examined and any data not meeting survey requirements were flagged as rejected. Sounding and laser data were reviewed and edited for data flyers. In each case, data was not eliminated and can be re-accepted in the future if required.

After swath editing, all data was reviewed through the Caris HIPS subset editing program to ensure no flyers remained in the data set, or to re-accept data previously flagged in the swath editor. In the Caris subset editor, a set of lines was reviewed together for line to line comparison to ensure agreement to one another in a Caris session.

5.1 Marine Survey Accuracy

Hydrographic data was acquired at the USACE specification for hard bottom dredge surveys which states an accuracy of +/- 0.5 feet vertically (in water depth less than 15 feet) and 6 feet horizontally for 95% of all data points. Quality assurance/control checks indicate better accuracies were achieved. Marine laser data comparison with upland data indicate achieved accuracies on the order of +/- 0.3 feet in both horizontal and vertical components in the majority of data points.

During the marine survey, several tripods with targets were setup over known control points on the dam. These targets were then scanned with the vessel mounted laser for accuracy assessment. Table 5 lists the results.

Table 5: Marine Laser Scan Data vs. Control Point Targets

<i>Monument Designation</i>	<i>Northing Difference (ft)</i>	<i>Easting Difference (ft)</i>	<i>Elevation Difference (ft)</i>
69001	0.10	-0.09	-0.10
69002	0.08	-0.16	-0.14
69003	0.10	-0.18	-0.14

6.0 UPLAND SURVEY METHODOLOGY

6.1 Survey Coverage

The upland portion of the survey included the front and back sides of the dam, and the right abutment. On the back of the dam, the survey extended from the easterly tree line on the right abutment to the spillway control tower. The survey included the face of the dam and the initial 1,000 feet of the right bank of the Green River.

Laser scanning was performed on the dam, along the right abutment, and along the Green River. Scan position and registration points, consisting of a 2-foot long rebar with plastic cap, were set throughout the face, back, and right abutment of the dam. Four cross sections were surveyed along the slope between the access roads on the right bank of the river. Also surveyed were 18-inch wooden hubs with a tack which were previously set along the cross sections.

Prior to the time of this survey, the right abutment of the dam was heavily modified by the construction of a new access road and concrete pad for the construction of the grout curtain. This construction destroyed many previously set scan control points. This area of construction is noted as “General Area of Construction” on the maps associated with the phase 3 post-construction December 2009 survey.

6.2 Survey Crew and Equipment

Prior to beginning the survey, field personnel met with the project manager to discuss the scope of work, detailed field procedures and site safety. Equipment (tripods, tribrachs, and survey instruments) used for the survey was checked and adjusted per the manufactures specifications prior to beginning the survey, with the check and adjustment noted in the survey field books.

A Leica TCRP1201, 1 second electronic total station, was utilized for horizontal and vertical control. Differential leveling was performed with a Leica DNA 03 digital level. A Leica ScanStation II was used for the laser scanning.

6.3 Survey Control

Existing control points 2200 and 2203 were used as the primary control points for the survey (see section 2.0 for primary control point values). Control point numbers 2202 and 10 were utilized to check the locations of the primary control points and to detect any movement in the primary control. From the primary control points the scan locations along the face and back of the dam were established. Four sets of angles and distance measurements were taken to all of the scan points and traverse points. Closed loop differential leveling was run from the site bench mark, control point 2203, through all of the laser scan control points.

6.4 High-Definition Laser Scanning

Thirty-one high-definition laser scans were taken throughout the surveyed area with a full 360° field of view. The laser scanner was set up over the rebar and cap scan position points. Targets were set over adjacent scan points to facilitate orienting the scans onto the NAD27 coordinates, and to verify the relative accuracy of the scan points. The scanner set up heights and scanning density were noted and will be duplicated for future monitoring to ensure consistency.

6.5 Conventional Cross-Sections

Four cross-sections were established on the slope between the upper access road and the right river bank (Figure 1). Each cross-section is a series of 18-inch wooden hubs with tacks set at approximately 25' intervals. In December 2009, a traverse and differential levels were run through the control points along the upper road. Each cross-section hub was then measured from the traverse point at the top of the hill. The results of these cross-section observations are shown in Table 6.

Figure 1: Conventional cross-sections



Table 6: Cross-Section Observations Results

<i>Point Number</i>	<i>March 2009 Elevation (ft.)</i>	<i>December 2009 Elevation (ft.)</i>	<i>Difference (ft.)</i>
68100	1198.95	1198.99	0.04
68101	1175.38	1175.42	0.04
68102	1149.84	1149.89	0.05
68103	1127.88	1127.88	0.00
68104	1196.59	1196.64	0.05
68105	1168.30	1168.34	0.04
68106	1140.43	1140.47	0.04
68107	1117.11	1117.12	0.01
68108	1096.58	1096.62	0.04
68109	1187.83	1187.85	0.02
68110	1164.41	UNABLE TO LOCATE	N/A
68111	1136.47	1136.48	0.01
68112	1115.71	1115.79	0.08
68113	1097.65	1097.72	0.07
68114	1189.86	1189.99	0.13

68115	1160.75	1160.81	0.06
68116	1128.20	1128.26	0.06
68117	1098.27	1098.34	0.07
68118	1094.03	1094.09	0.06

6.6 Upland Survey Accuracy

Control point and scan control point accuracy is 0.03 feet-horizontal and 0.01 feet-vertical, relative to the primary control. Cross section monitor point accuracy is 0.05 feet horizontally and vertically, relative to the traverse control point at the top of the section line. Laser scan accuracy is 0.04 feet relative to the scan control.

7.0 DATA EXPORT AND MERGING WITH UPLAND DATA

To take advantage of the level of detail the multibeam bathymetric survey provided for the dam monitoring, full resolution soundings were created by the HIPS processing software and exported to an ASCII XYZ file. The XYZ file was exported in NAD83/NAVD88 coordinates in meters and converted to the project coordinates (NAD27/NGVD29 US Feet) using CorpsCon version 6.0.1 The soundings from the full resolution multibeam data were loaded in to CARIS Bathy Database V 2.1 points from the mobile laser data and over 500 million raw topographic data points from the terrestrial laser system. The marine mobile laser data junctioned well with the terrestrial data. The merged datasets were processed into a 1 foot matrix using Bathy Database with the “Shoal Depth True Position” algorithm which also calculates a mean value based on all raw data within the 1 foot cell along with statistics on density (i.e., number of raw elevations) and standard deviation. The mean values, calculated at the center X,Y location of each cell, were used for differencing analysis in comparing with the March 2009 baseline data (which was reprocessed using the same gridding method).

The mean values from the combined December 2009 survey datasets, was used for differencing against the baseline survey conducted in March 2009, as well as, for producing an updated topographic map of the dam. The topographic map is displayed at 1” = 80’ scale drawing in sheet 1. The difference image is displayed as a color map at a 1” = 80’ scale in sheet 2. To enhance the interpretation of these data sets, a grid system has been overlaid on the maps of the front of the dam to allow focused view of detailed areas. The grid system consists of thirty, 150’ x 150’ areas which are referenced by rows (A, B and C) and columns (1 through 10). Areas within the reference grid where significant features occur (i.e., areas showing negative change in elevation over a horizontal area of approximately 10 square feet or more) are included in this report at a larger scale (1” = 20’) for better clarity. Detail areas B5 through B10 are included. Detail areas C4 and C10 are also included because they depict features of interest, possible grout build up and creek changes, respectively. The significant changes depicted along row A are attributed to extensive construction and grading and no details in that general area are include. Each anomaly

detail includes geographic coordinates to assist engineers in the field for inspection activities. General profiles across each feature are shown to help characterize the anomaly.

7.1 Data Interpretation

The December 2009 vs. baseline (March 2009) difference image (sheet 2) is predominantly comprised of grey shaded grid cells indicating no change greater than +/- 0.25 feet. This is also a very good indication of the general repeatability of the measuring systems utilized. Areas of no data (white) occur where either one or both of the survey grids had no elevations and therefore no difference could be calculated. Due to the significant shadowing which occurred because of large equipment operating during the baseline survey and lower data density due to submerged scan locations during the December 2009 survey, there are some significant areas which were shadowed and not covered. Most areas depicting change appear to have reasonable explanations, such as: increase in vegetation, road grading, extensive construction activity, wood debris which floated off, etc. A few significant areas (i.e., showing negative change in elevation over a horizontal area of approximately 10 square feet or more) were relayed to the USACE on 12/22/09 for quick field investigation.

This interpretation is DEA's general assessment of the more significant features of the data to help assist the engineers that will use it in understanding what the difference image depicts. The intent of the difference map is to make a graphical representation of elevation changes between the December 2009 survey and the baseline survey of March 2009 which can be used as a visual tool to help indicate to engineers and investigators possible areas which may need further inspection. It may be useful for those reviewing the maps to also reference the digital versions, both Microstation and PDF formats, which may produce sharper colors, magnification and better detail than can be produced on paper copies.

7.2 Deliverables

Deliverables consisted of the following:

- Color plan view maps of scan locations and 2-foot interval elevation contours
- Report documenting survey methodology, calibration procedures, data processing, quality assurance procedures, and statement of survey accuracy
- XYZ comma-delimited ASCII data at 1 foot grid spacing
- Two copies of CD containing ASCII data and electronic copies of report, drawings, and field notes.

EM 1110-2-1003
30 Nov 13

THIS PAGE INTENTIONALLY LEFT BLANK

APPENDIX P

Depth Measurement and Construction Payment in Unconsolidated Material

P-1. General Scope. Determining the clearance or payment grade is difficult when irregular rock fragments, soft strata, vegetation, or suspended sediments are present. Various mechanical and acoustic survey systems have been developed in attempts to assess and define clearance grades in these adverse conditions. Mechanical sweep methods were described in Chapter 10. This appendix focuses on depth measurement in projects with unconsolidated bottom material such as fluid mud or suspended sediments.

a. Suspended sediments in the water column will commonly occur during dredging activities when the excavation process has resuspended the bottom material, resulting in clouds of suspended sediment material, often termed "fluff." In some cases, relatively low-density saturated sediment (fluid mud) is naturally present, and a finite reference grade is difficult to define (especially for contract payment purposes). Other difficult depth measurement conditions include gassy sediments, moving bottoms, and vegetated bottoms. Also, small rock fragments may not reflect sufficient acoustic energy to be detected on standard echo sounders. Industrial waste can also create problem areas where there are large discharges of organic material, such as downstream of paper or pulp mills where the suspended organic material can be acoustically very reflective but have very low shear strength.

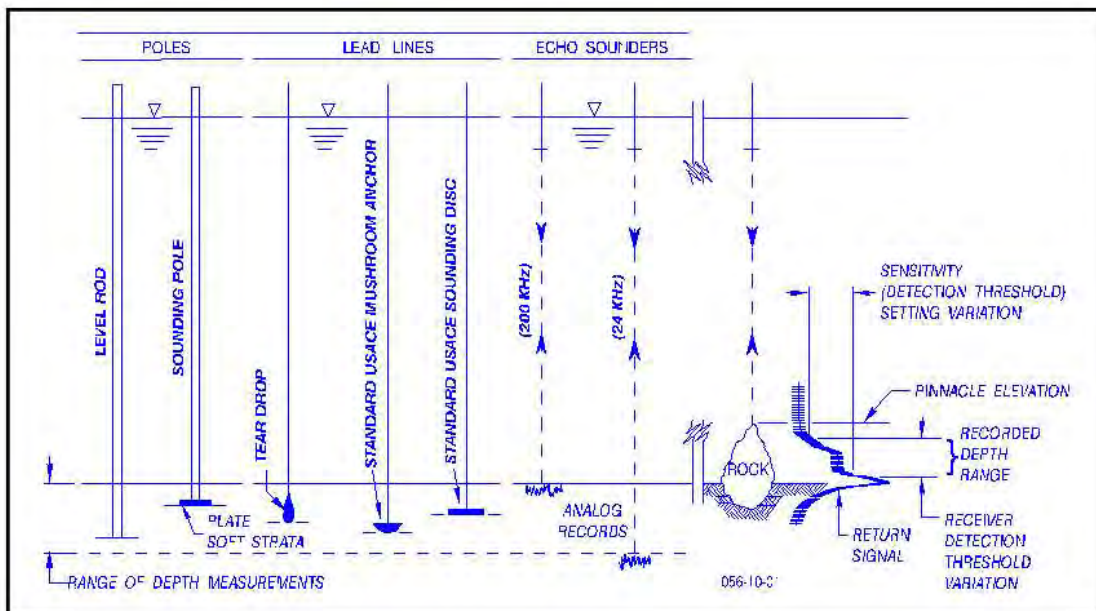

Figure P-1. Depth measurement variations in soft bottoms, illustrating variations between mechanical lead lines and acoustic methods. Acoustic returns on rock pinnacles also have uncertainties due to echo sounder threshold variations.

b. When the upper sediment layer is not well consolidated, the three major depth measurement methods used in USACE (echo sounding, leadline, and sounding pole) will generally not correlate with one another, or perhaps not even give consistent readings from one time to the next when the same type of instrument or technique is used. These potential variations in depth are illustrated in Figure P-1. This appendix presents information about the effects that difficult bottom conditions can have on hydrographic surveying methods and describes some optional methods of estimating depth data in unconsolidated bottom material. Although the primary focus is on measurement in suspended sediment conditions, it applies equally to other bottom conditions that present problems for acoustic measurements.

P-2. Causes of Suspended Acoustically Reflective Material. Causes of fluff layers, fluid mud, and other soft bottom conditions are not understood very well. A significant amount of research has been conducted to improve an understanding of these processes and to develop improved methods of determining and defining the nautical bottom. Fluid mud conditions are reported most frequently from districts that maintain waterways in the warm-weather sections of the country and are most prevalent in estuaries where mineral-laden fresh water mixes with salt water. Freshwater mineralogical sediment flocculation is accelerated when the sediment reaches saltwater. These flocculants are very loose aggregates that are 95% or greater water content and can hang in suspension for a long time. Several layers of progressively denser material can occur.

a. Dredging impacts. Conditions downstream from a dredge will probably also be quite different from those described in the preceding paragraph. The suspended material will not become stratified for some time after being resuspended by the dredge, and a return signal can result from reflection and dispersion of the signal from a wide vertical portion of the water column. While not applicable to depth measurements, acoustic reflection techniques have been used in research studies to survey spatial and temporal characteristics of plumes generated by dredging operations.

b. Currents. Swift natural currents also can cause turbulence that resuspends sediment material in clouds (fluff). This condition, like dredge plumes, can cause acoustic reflection that will obscure normal reflection from the more consolidated sediments of the waterway bottom. Acoustic reflection analysis of layer reflections does not apply to this condition.

c. Fluid mud and nautical bottom. Fluid mud is a high concentration aqueous suspension of fine grained sediment in which settling is substantially hindered by the proximity of sediment grains and flocculants, but which has not formed an interconnected matrix of bonds strong enough to eliminate the potential for mobility, leading to a persistent suspension (McAnally 2007). It can be characterized as suspensions with density gradations that range from slightly greater than that of the overlying water in its upper layers, to that of stiff, dense lower layers with mud densities ranging from 1050 to 1350 g/l, with concentrations ranging from 50 to 500 g/l or 2-13 percent solids by volume, and consist of silt and clay-sized material with clay minerals and organic material (Teeter, 1997).

d. In navigation channels with more consistent bottoms, e.g., sand, an underkeel clearance (distance between the central fore-aft structural member in the bottom of the hull and channel bottom) is used to account for parameters such as ship motion from waves, squat, safety clearance, water density etc., to avoid contact between ship and bottom. In channels with fluid mud, as per PIANC 1997,

“Although the upper part of the mud layer has a somewhat higher density than water, its rheological properties are comparable with those of water, so that a ship’s hull suffers no damage when it penetrates this interface. Even navigation with an under keel clearance which is negative referred to the interface can be considered, which implies that the ship’s keel is permanently in contact with the mud. On the other hand, safety of navigation requires that the pilot must always be able to compensate for the effects of mud on ship behavior by means of its own control systems or external assistance (e.g., tugs).

An acceptable compromise between the safety of navigation and the cost of channel maintenance can only be reached by introduction of non-conventional definitions and survey methods, and requires additional knowledge about the navigational response of ships in muddy water.”

e. To implement this alternative approach, the terms bottom and depth can be modified to nautical bottom and nautical depth where nautical bottom is defined (PIANC 1997) as

“the level where physical characteristics of the bottom reach a critical limit beyond which contact with a ship’s keel causes either damage or unacceptable effects on controllability and maneuverability,”

and nautical depth as

“the instantaneous and local vertical distance between the nautical bottom and undisturbed free water surface.”

f. To complete the definition of nautical bottom, the physical characteristic(s) on which the “critical limit” criterion is based and the criteria for “acceptable” ship behavior must be provided. Consequently from a practical and operational perspective (as per PIANC 1997), implementation of a nautical bottom concept requires:

- “ a practical criterion, i.e., selection of the physical mud characteristic acting as a parameter for the nautical bottom approach and its critical value;
- a practical survey method for continuous determination of the accepted level;

- a minimum value for the required underkeel clearance with reference to this nautical bottom, ensuring a minimal risk for contact with the latter and acceptable ship behavior;
- knowledge about ship behavior in these situation; if necessary, measures to compensate adverse effects on controllability and maneuverability.”

g. At the present time, density (with a critical value of 1.2 g/cm^3) is predominantly used throughout the world as the nautical bottom criterion.

h. For additional discussions on nautical bottoms see “Evaluation of Nautical Bottom Detection Techniques” (Sea Technology 2008). Vessel movement through fluid mud involves complex parameters such as the mud/water interface, stickiness or adhesion, bearing capacity, and deformation—for details on this research see “Rheology as a Survey Tool” (HYDRO International 2011).

P-3. Acoustic Depth Measurement in Suspended Sediments. Figure P-2 illustrates the kind of depth records that can occur when surveying with conventional single beam echo sounders over waterway bottoms with soft material surfaces or suspended material above the consolidated sediment surface. These analog records cannot be interpreted reliably unless other correlating information is developed. Automated depth digitizers may be even less reliable in providing a depth reading because such equipment cannot use any objective judgment in deciding whether to accept or reject the incoming information. Thus, the use of conventional survey systems does not help in this type of surveying environment, as far as getting good, reliable data is concerned. Records such as those depicted in this figure result from the fundamental principle on which acoustic depth sounding is based. When there is a sufficient difference in density (i.e., gradient) of the underwater material, some of the incident acoustic energy will be reflected. When using high-frequency transducers (i.e., 200 kHz), even very small density differentials will cause sufficient energy to be reflected, causing the depth sounder to display one or more returns. For this reason, lower or variable frequency transducers may be required to depict the bottom—Figure P-3. The following sections provide an overview on the principles whereby these density variations result in multiple returns in fluid mud.

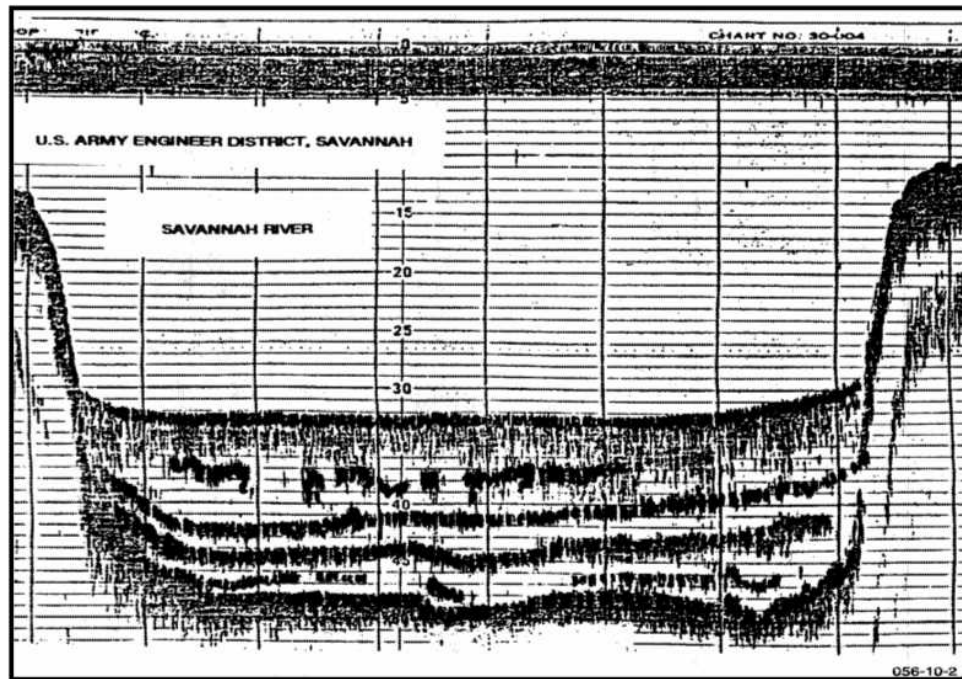

Figure P-2. Suspended sediment record in a section of the Savannah River ca 1970s. Upwards of 15 ft of low-density sediment layers are present. Frequency uncertain—probably a lower frequency given amount of penetration. (Savannah District)

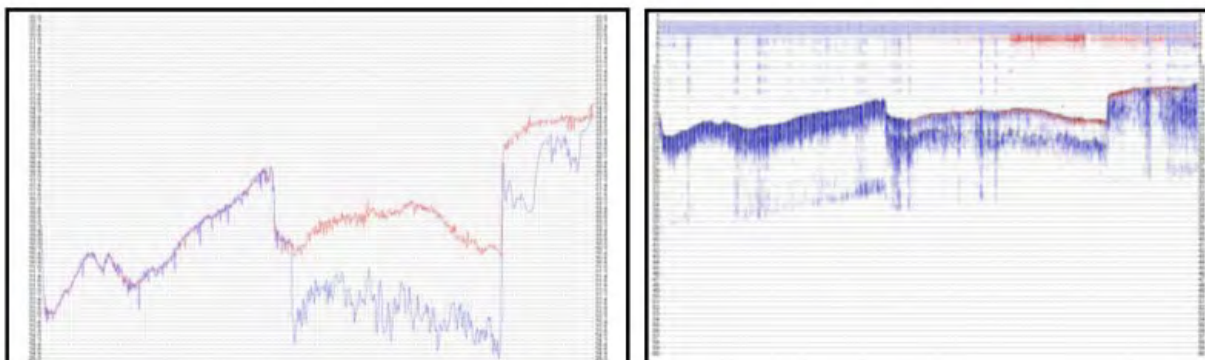

Figure P-3. 4 to 5 ft differences between high (200 kHz) and low (24 kHz) frequency Returns in fluid mud areas on the Atchafalaya River, LA (2011). (New Orleans District)

a. Velocity of sound in water. The velocity of sound in water is a function of the density and compressibility of the medium through which the sound is traveling. Compressibility is

technically related to the "bulk modulus elasticity" which is a function of temperature, salinity, or other dissolved materials.

b. Acoustic impedance. Acoustic impedance corresponds to the resistance of the medium to the wave propagating through it, i.e., a proportionality factor between the particle velocity and the acoustic pressure—see IHO 2005. In underwater acoustics, a related term ("specific acoustic impedance") is used. The specific acoustic impedance "Z" is a function of the density of the medium " ρ " and the velocity "c."

$$\text{Specific Acoustic Impedance: } Z = \rho \cdot c \quad (\text{Eq. P-1})$$

where,

Z is in Kg/(m²–sec) or Rayls

ρ (density) is in Kg / m³

c (velocity) is in m/sec

(1) Changes in the densities between the water and the bottom (or layered sediments) will change the acoustic impedance, resulting in reflected signals back to the sounder. Reflections at these density interfaces are also measured by "acoustic reflectivity" or "E."

$$\text{Acoustic Reflectivity } E = (Z_2 - Z_1) / (Z_2 + Z_1) \quad (\text{Eq. P-2})$$

where

Z_1 = acoustic impedance at layer 1

Z_2 = acoustic impedance at layer 2

(2) Figure P-4 illustrates the reflection of acoustic energy from multiple stratified layers of underwater material. The acoustic reflectivity at each layer is also shown. As energy generated from an acoustic source arrives at a boundary between two layers of differing material properties, part of the energy will be reflected back towards the surface and part transmitted downward. Portions of the transmitted energy will undergo absorption or attenuation in the layer while the remainder propagates through to the next stratigraphic boundary. Ratios between transmitted and reflected energy (reflection coefficients) are dependent on the density and velocity of the materials through which the energy is propagating. Systems have been developed to measure the density of bottom surface material and subbottom stratified sediment layers at different depths using these acoustic impedance techniques.

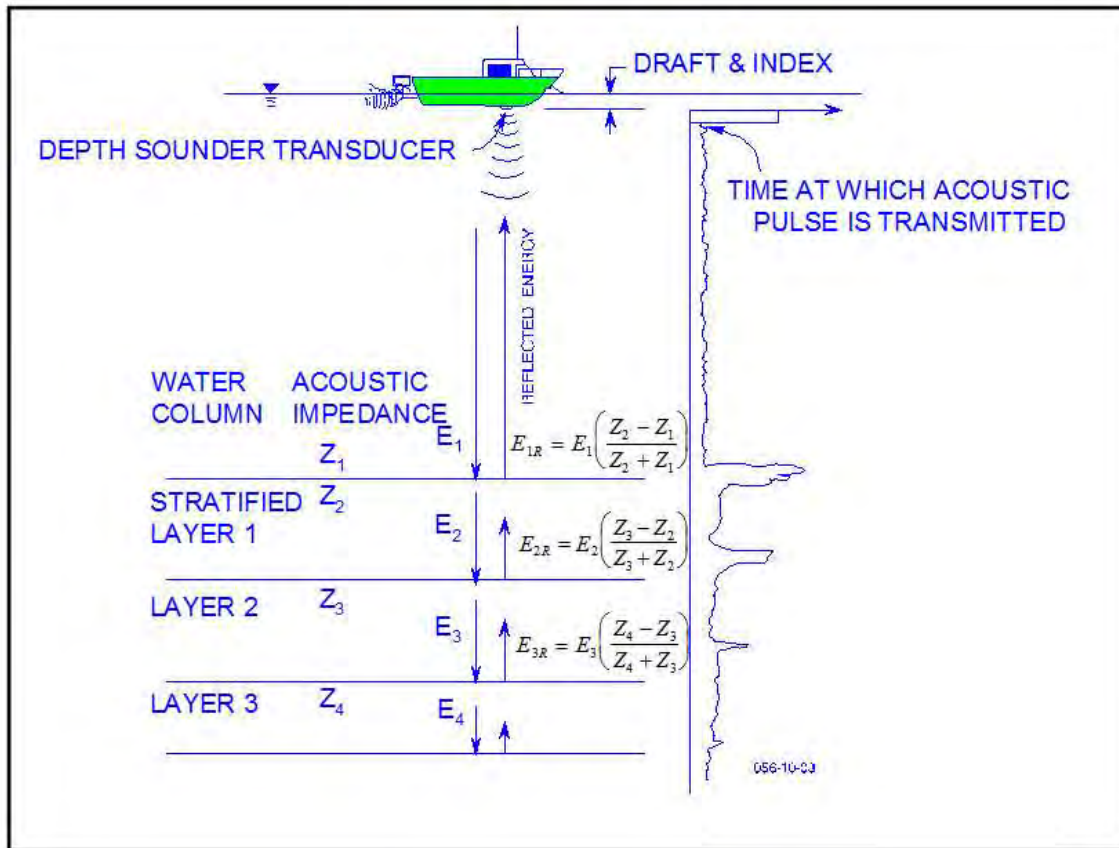

Figure P-4. Acoustic impedance (Z) and acoustic reflectivity (E) changes in differing sediment densities.

(3) Table P-1 lists impedances for water and various materials. Very small changes in impedance between two mediums will result in an acoustic reflection. The large change between water and hard materials results in solid, sharp returns, such as those received from a bar check. Air bubbles in the water also provide strong returns given the large difference in impedance between air and water.

Table P-1. Acoustic Impedance Values for Different Materials

Substance	Acoustic Impedance
Air	4.1×10^2
Fresh water	1.46×10^6
Salt water	1.54×10^6
Suspended sediments	(varies)

Fish skin	1.6 x 10 ⁶
Rubber	1.8 x 10 ⁶
Silty Clay	2.3 x 10 ⁶
Clayey Silt	2.5 x 10 ⁶
Silty Sand	2.9 x 10 ⁶
Very Fine Sand	3.1 x 10 ⁶
Fine Sand	3.2 x 10 ⁶
Medium Sand	3.3 x 10 ⁶
Coarse Sand	3.5 x 10 ⁶
Gravelly Sand	3.7 x 10 ⁶
Sandy Gravel	3.9 x 10 ⁶
Clay (hard)	7.7 x 10 ⁶
Rock	1.5 x 10 ⁷
Steel	4.7 x 10 ⁷

c. Reverberation and scattering (R2Sonic 2010). The sea is not homogenous in nature. Everything from suspended sediment particles to fish, from the sea surface to the sea floor will scatter, that is reradiate, the acoustic energy. All of the effects of individual scattering can be termed reverberation. The effect of reverberation is to lessen the acoustic energy and this leads to transmission losses. Reverberation is divided into three main areas: sea surface reverberation, bottom reverberation, and volume reverberation (the body of water that the energy is passing through). Both the sea surface and the sea bottom will reflect and scatter sound, thus affecting the propagation of sound. Sea surface scattering is influenced by how rough the sea is (which is related to wind velocity) and also the trapped air bubbles in the near surface region. The sea surface is also a good reflector of acoustic energy; this can lead to second and even tertiary bottom returns as the bottom return acoustic energy is reflected by the sea surface and is then reflected once more by the sea bottom. In the case of the sea floor, the strength of the scattering depends on the type of bottom (composition and roughness), the grazing angle of the acoustic pulse and the operating frequency of the sonar.

(1) There is also bottom absorption based on the sea floor terrain and composition. Bottom absorption is also dependent on the operating frequency of the sonar and the angle of incidence. Bottom absorption will be greater for a higher frequency and large angle of incidence. It is more or less intuitive that a mud bottom will absorb more of the acoustic energy than a rocky bottom. When the acoustic energy is absorbed it means there is less that will be reflected back to the receivers. The surveyor must be aware of the bottom composition as adjustments can be made to the receiving system's operating parameters to help compensate for the bottom absorption.

(2) In waters with a large sediment load, the suspended particles will scatter the sound wave, thus leading to transmission loss. In the scattering process, there is also a degree of energy that it is reflected (backscatter); this can be a cause for 'noise' in the sonar data. Again, the

surveyor should be aware of this condition and, if need be, change the operating parameters of the recording system. When discussing the changing of the operating parameters, it is generally a matter of increasing transmit power or pulse length to get more total power into the water. In some circumstances, increasing the absorption value will allow the system to rapidly increase gain to capture the reflected energy that has been dissipated by seafloor absorption or scattering in the water column.

(3) As noted above many of the effects of absorption, scattering, and bottom absorption are frequency dependent. On variable frequency echo-sounder systems, such as the R2Sonic 2024, the operator can adjust the sonar frequency to optimize the system for the survey conditions. This will take some trial and error; however, lower frequencies tend to do best in areas of absorbent bottom and high sediment load (scatter).

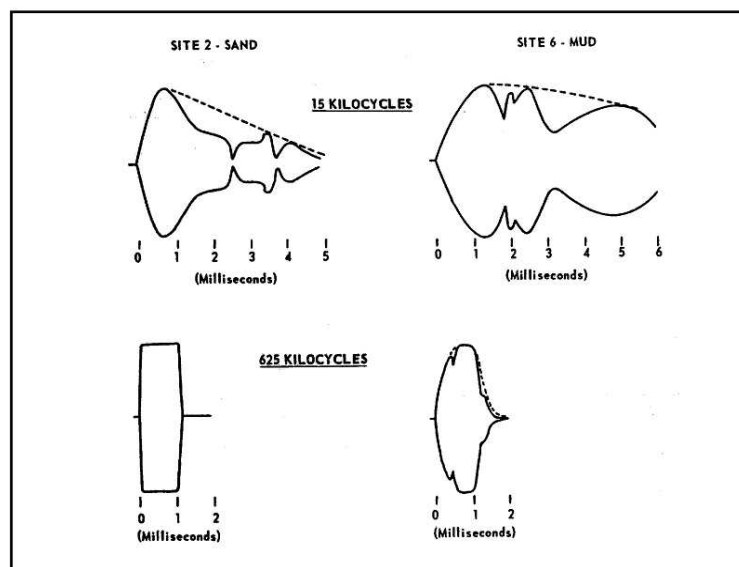

Figure P-5. Signal return variations at different frequencies from sand and mud.

d. Echo sounder gain or sensitivity control. An important point to remember is that the amplitude of the first signal return is proportional to the density of the upper layer. Thus, a hard sand surface layer will give a much stronger signal return than a low-density fluff surface layer, no matter what frequency is used (see Figure P-5). Keeping this fact in mind can be helpful in making a rational setting of the transmit power and sensitivity controls on a depth sounder. Consider the situation in which a survey is under way and the depth recorder (analog chart or digital display) begins to print (display) irregularly in a particular area. The natural tendency is to adjust the depth recorder sensitivity control until the depth recorder prints (displays) a solid line again. Increasing the sensitivity of the recorder permits the display of a signal return from a softer bottom. The potential problem with this type of adjustment is that the higher sensitivity

may cause the depth recorder to register a "fluff" layer and not a true bottom. Thus, one should not "crank up" the sensitivity control to keep a solid line on the recorder and do nothing else. If a sensitivity adjustment is necessary, it is also necessary to make a correlating depth check using one of the alternate depth measurement techniques described in this appendix. If the alternate method agrees with the depth recorder, the sensitivity adjustment is probably warranted. If there is no correlation, use of the alternate depth measurement method is indicated.

d. Acoustic signal return in multiple sediment layers. When acoustic energy hits the upper surface of an underwater layer of material, some of the incident energy is reflected and some continues downward through that layer and hits the next layer. At the next interface, some of the energy is reflected and some continues downward. At each interface between layers, this process continues, with the incident energy becoming smaller with each transition due to reflection, attenuation, and scattering. Energy is reflected principally at the interface surfaces between layers and not in the interior of the layers, except where particles within a layer cause a local density gradient. Figure P-6 depicts a 24 kHz signal return from multiple layers of material.

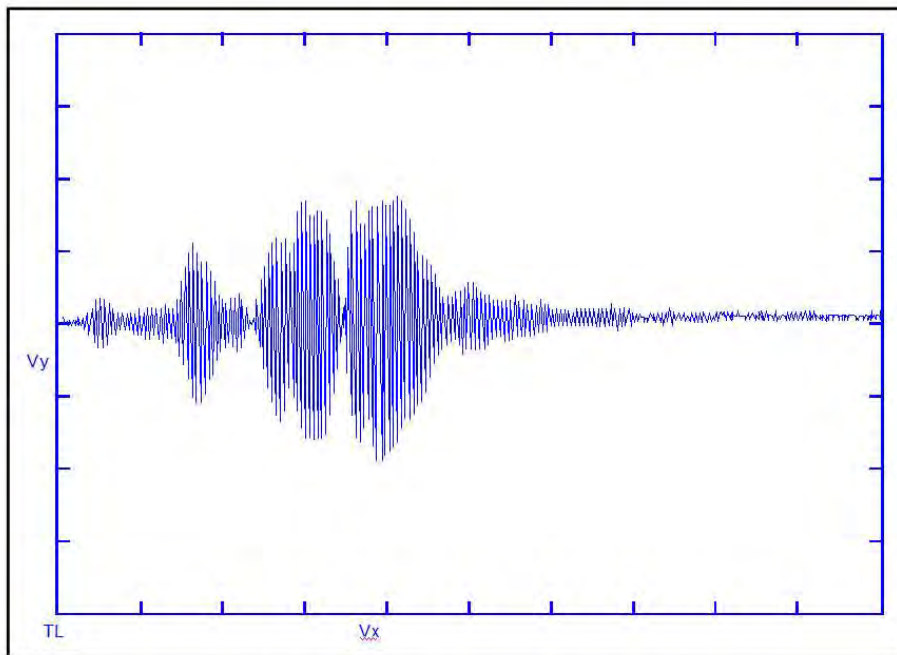

Figure P-6. 24 kHz signal return in multiple sediment layers.

P-4. Attenuation of Acoustic Energy in Suspended Sediments. Attenuation is the loss in energy of a propagating wave due to absorption, spherical spreading, and scattering by particles in the water column—see IHO 2005. As acoustic energy passes through a material such as water, underwater sediments, or suspended material, some of the energy is absorbed and the signal becomes weaker with the distance traversed. Energy absorption is referred to as “attenuation”

and is usually given in decibels (dB). Different types of underwater materials will have different attenuation effects, and signal calculations must take this factor into account. At each interface surface, the downward-going acoustic energy will be reduced by both the preceding reflection reduction and the attenuation loss. The upward-going acoustic energy suffers the same reduction in amplitude ratio as does the downward-going energy (from attenuation and reflection redirection at each layer interface). These effects are doubled on the upward-going energy through the soil layers because it has twice the path length to traverse and must lose a proportion of reflected energy at each interface surface. Thus, because of the attenuation and reflection, a progressively smaller portion of the reflected energy comes from the lower layers of sediment, and the reduction in signal amplitude is drastic. The signal strength returning to the depth sounder transducer is an extremely small percentage of the transmitted energy. Only by electronic amplification is it possible to detect such minute signals.

a. Effect of frequency on attenuation. Attenuation of acoustic energy is proportional to the frequency, as illustrated in Figure P-7. Thus, 200 kHz energy is attenuated much more rapidly than 24 kHz energy when passing through the same material. Since high-frequency energy is attenuated more than low-frequency energy, a much smaller proportion of the high-frequency energy comes back to the depth sounder transducer from the lower layers of sediments than is the case with the low-frequency energy.

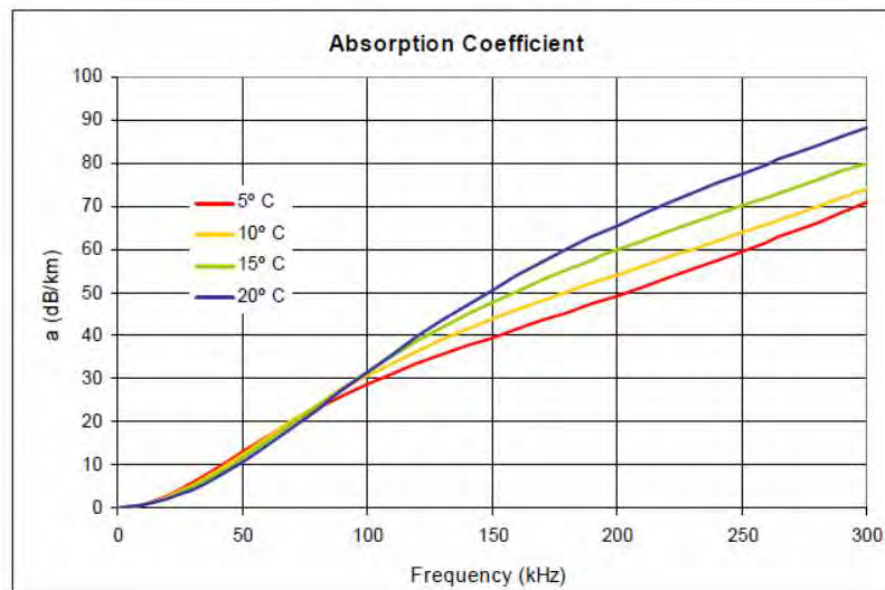

Figure P-7. Acoustic signal attenuation versus frequency. The rate of absorption is also dependent on the physical and chemical (primarily magnesium sulphate) properties of seawater. (IHO 2005)

b. Attenuation of different frequencies in suspended sediment layers. An example showing the effect of attenuation as a function of frequency is given in Figure P-8. This is a graph of the amplitude of the output from a 200-kHz transducer (upper curve) and the output from a 24 kHz transducer (lower curve). The two transducers were mounted side-by-side and aligned so that the response pattern of both transducers was vertical. Both transducers transmitted simultaneously, and the time scale is the same for both transducers. The 200 kHz channel was adjusted to have a higher gain than the 24-kHz channel so that the maximum amplitude of both channels, as viewed on the graph, was comparable. Due to the high attenuation of the 200 kHz signal, there is no detectable energy received from the lower sediment layers even though they had a higher density. The 24-kHz signal shows a maximum amplitude at one of the lower sediment layers because the attenuation of the 24-kHz signal in the upper layer is relatively low and the reflectivity of the upper layer is quite low. In this example, both transducers show the reception of first reflected energy at the same time. The 24-kHz energy reflected by the upper layer (the primary reflector of 200 kHz energy) appears to be very low in amplitude. The amplitude of the first layer reflection is, however, just as large at 24 kHz as it is at 200 kHz. However, the ratio of this reflectivity to the lower reflectivity gives the higher amplitude at the lower layer. The main point is that the reflectivity is about the same at both frequencies, but the attenuation is much higher for the higher frequency. The net result is that the high-frequency depth channel normally registers the upper layer of reflective material, even a very low-density one, and the lower frequency depth channel will register a lower layer if that lower layer has a higher acoustic reflectivity than the upper layer. Low-frequency depth sounders will always penetrate to a lower depth than will higher frequency energy at the same transmitting power level and receiver sensitivity. From a hard upper surface such as sand or rock, the surface reflection will be the maximum reflection amplitude for either a high- or a low-frequency signal.

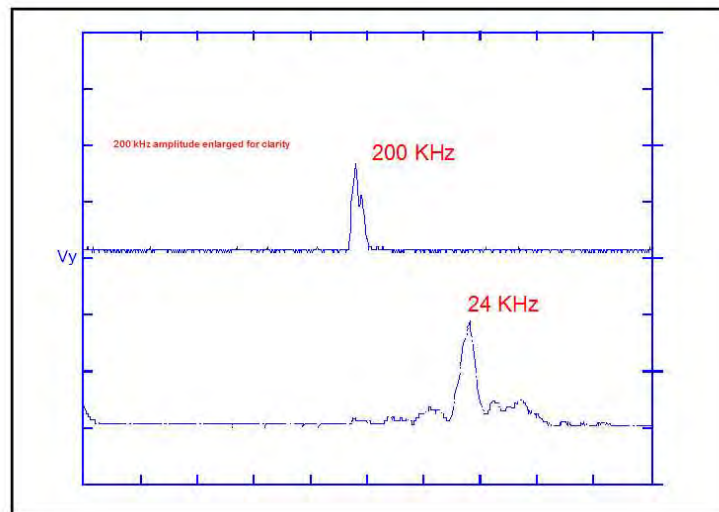

Figure P-8. Comparison of 24- and 200-kHz signal attenuations

P-5. Effects of Surface Roughness and Incident Angle. Amplitude of the reflected signal will be affected by both the surface roughness and the incident angle. For depth sounding over level bottoms, the acoustic path will be close to vertical when using narrow-beam transducers or vertically aligned transducers. This simplified assumption is not valid for multibeam systems and when working with single-beam systems over sloping surfaces, when the survey boat is pitching and rolling, or when the transducer is not narrow-beam.

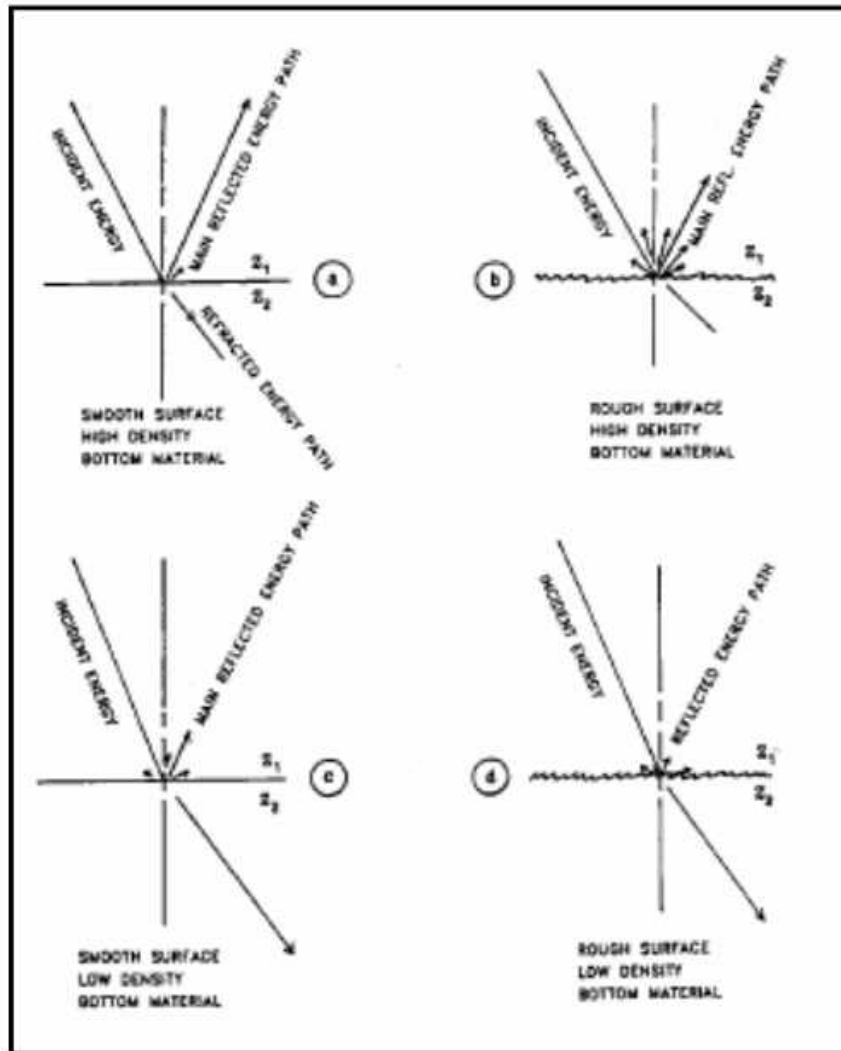

Figure P-9. Effect of surface roughness on reflected acoustic energy.

a. The four quadrants of Figure P-9 illustrate some effects of surface roughness and bottom surface density. Quadrant P-9a illustrates the reflection, refraction, and dispersion effects on a smooth hard bottom surface. Under these conditions, a high percentage of the incident energy is reflected and the dispersion of the reflected signal is low. Low dispersion results in a stronger

signal along the reflection path. A vertical signal path and level bottom give the strongest possible signal return to the depth transducer. If the bottom surface is a sloping rock surface, a very low signal return may result because the energy would be directed away from the transducer in much the way a mirror reflects light. For this reason, small irregularly shaped rock fragments with smooth surfaces may go undetected by conventional echo sounders.

b. Quadrant P-9b illustrates the reflection, refraction, and dispersion effects on a rough high-density bottom surface. In this instance, a much higher percentage of the incident energy is dispersed at angles different from the main reflection path. High dispersion results in a lower signal along the main reflection path. When the signal path is vertical and the bottom is level, there is a weaker signal return to the depth sounder transducer than under the conditions shown in quadrant P-9a. When the bottom surface is not level, the rough surface illustrated in quadrant P-9b may give a higher signal return than the smooth surface. As an example, a rough-surfaced boulder would be much easier to detect than a smooth-surfaced boulder.

c. Quadrant P-9c illustrates the reflection, refraction, and dispersion effects from a smooth low-density bottom surface. A fluff layer in a channel without wind or currents to disturb the surface would approximate this condition. In this instance, low dispersion results in a stronger signal path along the reflection path. If the signal path is vertical and the bottom is level, most of the reflected energy is directed back at the transducer. The reflected energy would still be relatively low due to the low density. It is improbable that a low-density material will have other than a small surface angle because it will migrate down the slope.

d. Quadrant P-9d illustrates the reflection, refraction, and dispersion effects from a rough low-density bottom surface. A fluff layer in a channel with wind or current to disturb the surface would approximate this condition. In this instance, the high dispersion in the surface reflection results in a weaker signal along the reflection path than the conditions illustrated in quadrant P-9c.

e. The IHO Manual on Hydrography (IHO 2005) presents a more detailed treatment on acoustic dispersion, reflection, and backscattering. In this manual, these effects are expressed in a 'Sonar Equation' which is used to "study and express the detection capability and performance of echo sounders as a function of operating conditions ... and to understand the processes involved in acoustic signal propagation and echo detection." The sonar equation for echo sounders defines the signal or echo detection as the Echo Excess (EE),

$$EE = SL - 2 TL - (NL-DI) + BS - DT \quad (\text{Eq P-3})$$

where SL = source level, TL = transmission loss, NL = noise level, DI = directivity index, BS = bottom backscattering strength, and DT = detection threshold. Refer to Chapter 3 of the IHO Manual on Hydrography for a detailed explanation of the terms in the Sonar Equation. Of particular interest in evaluating suspended sediments is the seabed Backscattering Strength (BS),

which is dependent on the reflective properties of the seafloor and the effective signal scattering area.

P-6. Dual-Frequency Acoustic Depth Measurements in Suspended Sediment Conditions. Dual-frequency echo sounders are commonly employed by the Corps in areas where fluff or fluid mud is present. In order to assess the data quality between the high and low frequency returns, it is helpful to be aware of some of the characteristics of each frequency, as listed in Table P-2 below. Figures P-10 and P-11 illustrate dual frequency records from typical echo sounders.

Table P-2. High- and Low Frequency Characteristics.

High-frequency echo sounders – 200 kHz typical

- Narrow beam—small transducer size/weight
- More accurate depth measurement & resolution
- Picks up small density changes
- Will pick up multiple fluff layers ... Grass, kelp
- Will record vegetation above hard bottom
- Lower power requirements
- Side echos minimized
- Digital depths easier to obtain
- Must be directly over object to detect (obtain return)
- Limited in depth range... few hundred feet
- More difficult to obtain bar check

Low frequency echo sounders – 24 kHz typical

- Wider beam ...large transducer size/weight
- Less accurate depth measurement & resolution ... side echos smooth out features
- Bar check calibration easy
- May detect “truer” bottom
- May penetrate through bottom grass
- Will not detect small density changes
- Higher power requirements
- Increased depth range.

General features of high and low frequencies

- Acoustic energy is absorbed at each density layer
- Reflected energy also absorbed on return path
- Returning signal strength is very small (amplifying signal becomes problem)
- 200 kHz energy attenuated 10 times more than 20 kHz
- Low frequency may not pick up initial density change if small
- Low frequency may penetrate to sub-surface rock
- Signal return amplitude proportional to density of return surface

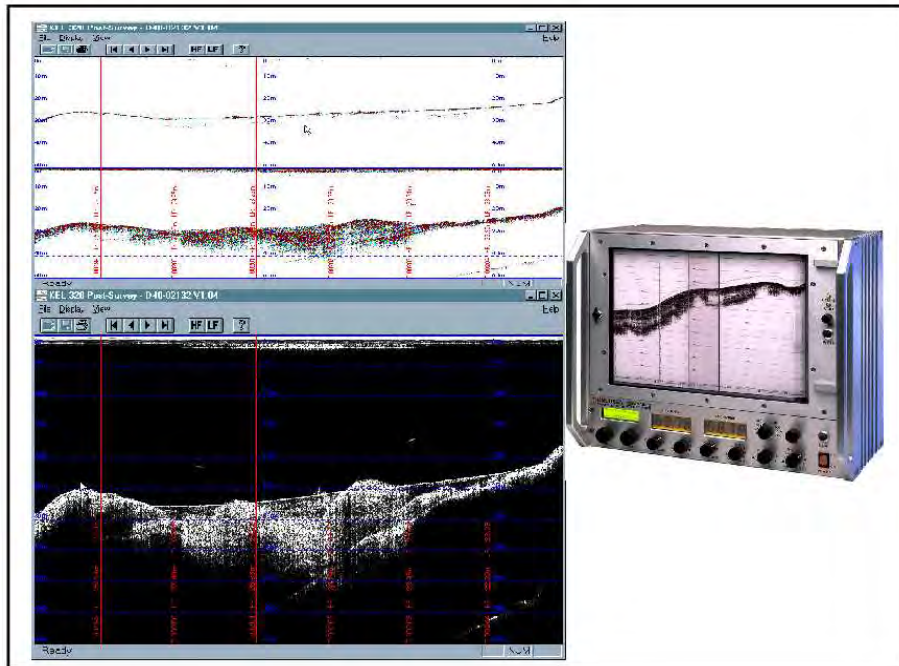

Figure P-10. Knudsen 320M dual frequency recorder (24 kHz and 210 kHz). The upper part of the figure shows the profiles recorded by the two separate frequencies. The bottom part shows the merged records in color-reverse grayscale.

P-7. Dual Frequency Parametric Subbottom Profiling. The Innomar SES-2000 parametric profiling echo sounder (Figure P-12) uses the combination of two or more frequencies to measure subsurface layers and objects, such as pipelines. It can operate in water depths down to 400 m with penetration up to 50 meters, and can resolve embedded objects or sediment layers as small as 5 cm. The term "parametric" refers to the mixing of frequencies to form sum and difference frequencies. Returns from the two high and low frequencies are added and subtracted, with the frequency difference being used to evaluate and measure penetrated sub-surface layers. Both frequencies have the same beam width. For small object detection, the survey vessel speed is kept to less than 2 kts during surveys. Applications of parametric frequency measurements are listed in Table P-3.

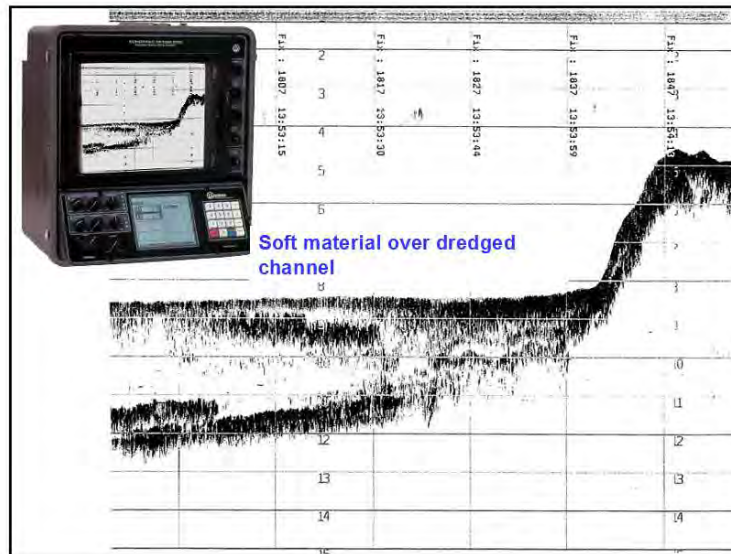

Figure P-11. Teledyne Odom Hydrographic ECHOTRAC MKIII dual frequency thermal echo sounder (24 kHz and 200 kHz), depicting soft sediment material over dredged channel.

Table P-3. Dual Frequency Parametric Profiling Applications.

Geological and geophysical explorations
Soil investigation campaigns for dredging projects
Route Surveys for pipeline and cable laying projects
Detection of fluid mud and sediment structures for dredging tasks
Search for mineral resources
Surveys of small and shallow waters, gravel pits, harbor basins, flood gates, shore zones
Search for objects, wrecks, pipelines, sea cables, navigation obstacles, stones, toxic wastes
Archaeological investigations for wrecks, historical buildings, and settlements

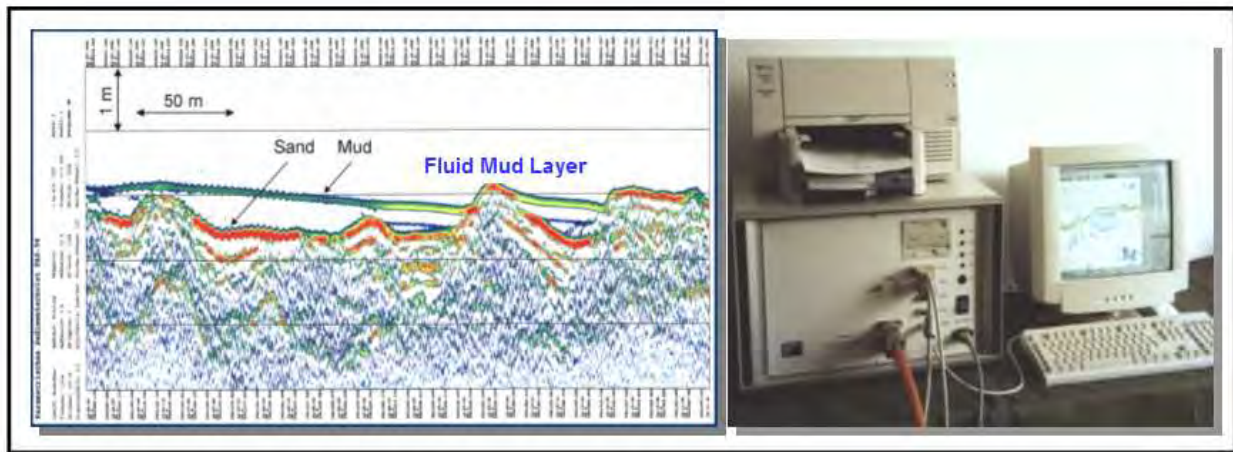

Figure P-12. SES-96 (SES-2000) Dual frequency profiling system. Enhanced processing of signals can identify different material layers in a channel, including fluid mud. (Innomar Technologie GmbH)

P-8. Alternative Depth Measurement Techniques in Suspended Sediments. The preceding paragraphs described the principles underlying the operation of acoustic depth sounders and limitations of this measurement technique in complex bottom conditions. All depth measuring techniques in fluid mud layers, including mechanical lead lines, have their limitations and constraints. The following paragraphs describe the uses and limitations of other depth measurement methods in suspended sediments or fluid mud layers. Not all of the following methods have practical application in that they were limited to research projects by the US Army Engineer Research and Development Center's (ERDC) Coastal and Hydraulics Laboratory.

a. Lead lines or sounding disks. Mechanical depth measurement using a lead line or sounding disk is usually considered a slow but very reliable method of determining depth. With hard bottom material, this assumption is valid. However, with soft bottom materials, it may not be. A variety of lead weights are used, such as mushroom anchors and round flat plates 4 to 12 inches in diameter. A lead weight will fall until the shear strength of the sediment is sufficient to stop the vertical movement of the weight. The high density of the lead weight is such that it will never come to an equilibrium depth on the basis of density. The shear strength of sediments can be affected by the velocity of the lead weight, stirring action, and the amount of time that the weight is allowed to rest on the soft sediment.

(1) As a result, two different people using the same lead line can get different results, depending on the length of time the weight is allowed to rest on the bottom and whether or not the weight is jiggled a bit to feel the bottom. With soft bottoms, it is difficult to feel when the weight actually touches bottom—i.e., hits "refusal." Moving the weight while it is on the bottom tends to break down the internal structure of the soft sediment and convert it from a semi-solid to a viscous liquid, causing the lead line to sink deeper than if handled otherwise.

(2) In addition to not stopping at a consistent level, a lead line may not stop at a level that is an acceptable nautical bottom. For instance, a lead line may pass through a sediment layer with a consistency of mayonnaise, but this kind of mud layer would probably so disrupt a ship's steering that it would be unacceptable to shipping interests. A sediment with a mayonnaise-like consistency would, however, probably give a good response on an acoustic depth sounder. This also would be the correct surface to call bottom for dredge clearance and payment evaluation. This example is given to show that when acoustic depth sounders and lead lines disagree, the assumption should not be made that the lead line is the correct depth. Other correlating information may need to be developed.

(3) The accuracy of lead line depth measurements degrades considerably when currents are present, causing excessive slope in the line. In such conditions, and in depths greater than 20 ft, lead line accuracy exceeds ± 0.5 ft. In depths exceeding 40 ft, lead line observations are, at best, around the ± 1 ft range.

(4) Even with the above deficiencies in lead line measurements, it is still the most common method used by the Corps to correlate echo sounder readings when suspended sediments are present. Lead line observations are compared with high- and low-frequency recordings to assess channel clearance and to arrive at an equitable payment for material removed.

(5) Sounding poles or expandable (25-ft) level rods have been used on some projects to measure refusal depths in soft bottoms. A fixed plate should be attached to the bottom of the pole/rod to provide resistance. As with lead lines, determining the depth refusal point is extremely subjective and operator dependent. Depth measurements are generally limited to about 15 ft.

b. Nuclear density probes. Nuclear density probes can be used to measure the density of bottom sediments. Most nuclear density probes work on the principle that a more dense material will absorb a higher percentage of the radiation passing from the source to the detector than will a less dense material.

(1) A typical probe is configured so that the sediment material passes between the source and detector as the probe is lowered. Nuclear density probes can give an accurate graph of sediment density as a function of depth if properly calibrated and used.

(2) Nuclear density probes are used as a nautical bottom depth measuring technique in The Netherlands and Belgium, where fluid mud is a widespread condition.

(3) Nuclear density probes will not work in areas where there has been a discharge of radioactive material into the waterway. Calibration of nuclear density probes depends on having a uniform natural background radiation level in the area when the probe is to be used. Water discharged from industrial and government facilities has sometimes in the past contaminated the

sediments with low-level radioactive wastes. These wastes distort the background radiation level and will cause measurement error of the sediments apparent density.

(4) Another limitation to the use of nuclear density probes is the increased regulations governing their use, including the extensive paperwork involved. Nuclear density probes can be used only by licensed personnel, and the probes must be stored under special conditions that are expensive to implement and maintain. As a result, nuclear density measurements are not practical for most Corps dredging applications.

c. Mechanical towed sled method. A 260-lb towed sled system was developed at the USACE Waterways Experiment Station (now ERDC) in the 1970's to measure fluid mud shear strength and density measurements. This system modeled the ability of a vessel to navigate, given a resistance developed by the fluid mud. The sled (a direct contact method) depicted the boundary between suspended and consolidated silt. Sled sensors measured hydrostatic pressure, sled velocity, sled attitude, nuclear density, and cable tension. A crane winch assembly was required to operate the sled system. The depth of the sled was determined by the hydrostatic pressure (head) gages on the sled. For hard-bottom channels the head gage was inferior, but for unconsolidated channel bottoms the sled was used to measure the material density which can impede a ship's navigation in the channel. In tests conducted at Gulfport Channel (MS), the 200 kHz transducer was more consistent than the sled after repeated runs along the channel centerline. The sled was more consistent than the 24 kHz system. Weight was added to the sled in order to follow a density of $1.2 \text{ g/cm}^3 \pm 0.1 \text{ g/cm}^3$. The 200 kHz transducer was estimated to reflect off material at 1.05 specific gravity. This tool was not intended to replace acoustic depth measurement, but to augment soundings in areas of fluid mud.

d. High Resolution Density Profiler (HRDP). An Interagency Agreement (IAG) was signed between the ERDC and USEPA's Environmental Sciences Division (ESD) of the Office of Research and Development's National Exposure Research Laboratory, the objective of which is to have ERDC modify the ADMODUS probe (an acoustic impedance-based navigation fluid mud survey prototype system successfully demonstrated in the Gulfport, MS navigation channel and in the laboratory) for use in characterizing dredge residuals for environmental dredge projects. Dredging residuals refer to contaminated sediment found at the post-dredging surface of the sediment profile, either within or adjacent to the dredging footprint. After the initial consolidation period (i.e., within a period of several days to a few weeks, depending on sediment characteristics and site conditions), generated residuals (excluding sloughed materials) typically occur as a thin veneer (1 to 10 cm thick) of fine-grained suspended material.

(1) One of the goals in developing this new sensor system (this is a current--2013--R&D project under the Dredging Operations and Environmental Research (DOER) program) is to produce an instrument that uses easy-to-obtain, and well supported, acoustic-signal processing hardware and non-proprietary signal processing techniques. The new sensor system is named the High Resolution Density Profiler (HRDP). The HRDP operational methodology to calculate density is based on the measurement of three ultrasound parameters:

- Acoustic impedance of the medium (Z_{med})
- Sound speed within the medium (c_{med})
- Ultrasound transmission characteristics (attenuation) of the medium

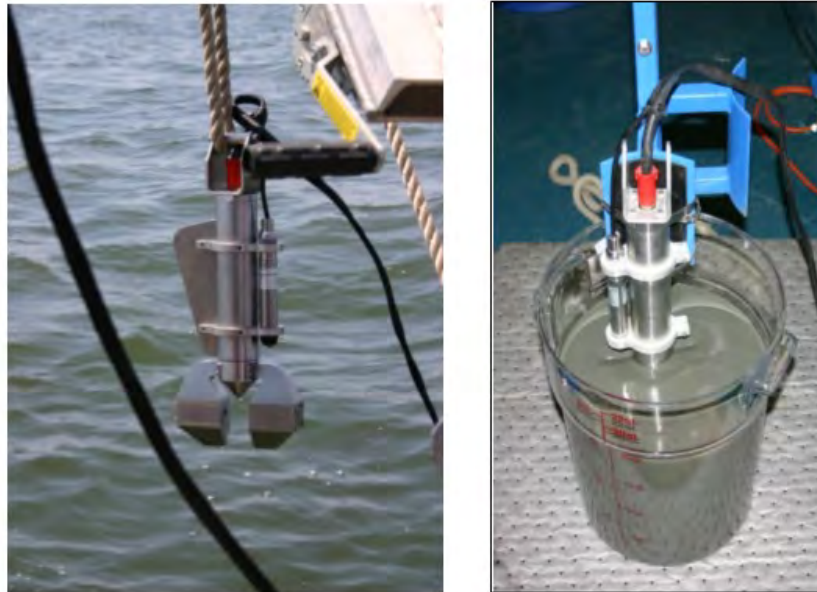

Figure P-13 High Resolution Density Profiler (HRDP) and its immersion in a static (fluid mud) bucket test.

(2) The prototype probe (shown in figure P-13) was tested in “static” buckets of various (bulk) density suspensions of fluid mud collected from the Gulfport (MS) Ship Channel, and compared to laboratory pycnometer measured densities. The results from these comparisons are shown in Table P-4. Based on these promising results, the HRDP is currently (2013) being modified for subsequent laboratory and field testing.

Table P-4. HRDP measured densities compared with pycnometer measured densities.

Pycnometer Density	Average HRDP Density	HRDP Standard Deviation	Difference HRDP-Pycnometer
0.997*	0.995	0.002	-0.002
1.082	1.092	0.029	0.010
1.127	1.125	0.005	-0.002
1.141	1.133	0.007	-0.008
1.170	1.166	0.006	-0.004
1.193	1.228	0.005	-0.035

Values are in g/cm^3

e. GraviProbe. The GraviProbe is a rheological and density profiling system designed to; (1) determine the depth and thickness of underwater sediment layers, (2) provide additional information on the sediment structure and build up in relation with multibeam echo sounder and seismic data, and (3) measure nautical depth. It's a free fall impact instrument that analyzes the underwater sediment layers by intrusion. Under its own weight it accelerates and penetrates fluid and consolidated mud layers (the intrusion depth can go up to several meters). It has a weight of 7 to 10 kg and a terminal free fall velocity of about 6.5 m/s. The dimensions of the mud version are 1 m length and 0.05 m diameter (see Figure P-14).



Figure P-14. GraviProbe Kit.

Density and shear strength of the sediment layers are measured by an independent set of sensors and a pressure sensor is used to determine the pore pressure in the soft sediment layers and derive the density. The density is (reportedly) determined every 0.005 m with a resolution of 2%. The data from on board accelerometers feed a dynamic model and resistance model of the intruded medium. Figure P-15 shows a GraviProbe profile of density and shear strength vs. depth.

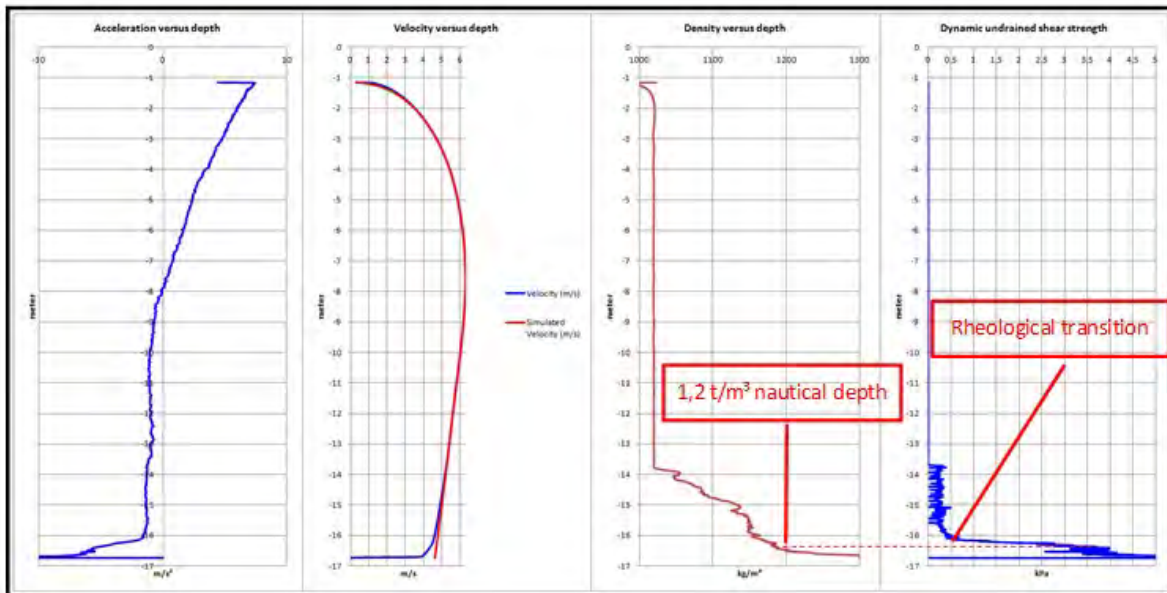

Figure P-15 GraviProbe profile of density and shear strength vs. depth.

f. The Rheocable Method. The Rheocable is designed to determine the nautical depth as defined by the rheological transition level based upon the rheological properties (viscosity) of the mud rather than density. The Rheocable Method is designed to detect the interface between fluid and solid mud. A towed object, when kept in a velocity window, is (reportedly) always positioned at this interface between fluid and solid mud, thereby making it possible to develop a new maintenance dredging strategy - leave/ignore the fluid mud and remove only the solid mud. The Rheocable Method utilizes a weighted pressure sensor package connected to a data display deck unit (see Figure P-16) dragged along the seabed as illustrated in Figure P-17). The pressure sensor is placed in a sealed pressure pod with two circulation tubes reaching above the liquid mud layer to ensure the correct translation of pressure measurements into water depths based on the known density of seawater. The water density is continuously measured at several levels along the umbilical cable using CTD (Conductivity-Temperature-Depth) probes. During post processing, pressure/depth is further compensated for atmospheric pressure. Following the sensor package is a short resistivity cable. The resistivity cable is used to verify that the sensor package is traveling on the liquid/solid mud interface and not floating above the interface. For routine applications the Rheocable method requires a constant tow speed ranging from normal survey speeds of 3 to 5 knots. More detailed information regarding the Rheocable Method is available in Druyts and Brabers (2012). Figure P-18 shows the difference plot between the Rheocable depth measurement and a 33-kHz survey system depth measurement from a demonstration survey in the Wilmington Harbor, DE, on the Christiana River in 2012.



Figure P-16. Rheocable Method towed array and deck unit.

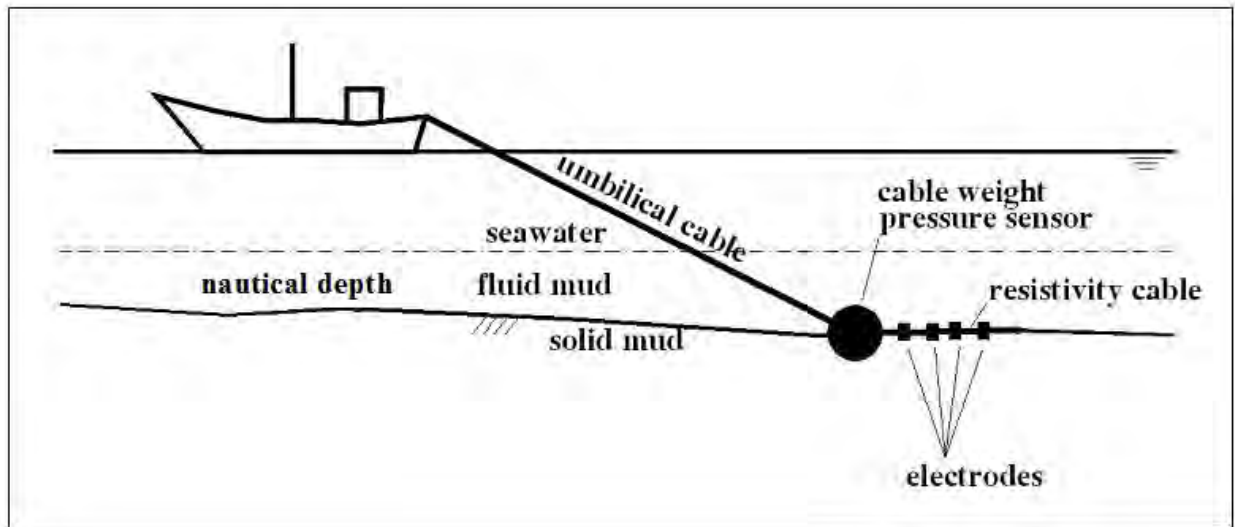

Figure P-17. Rheocable deployment operational methodology.

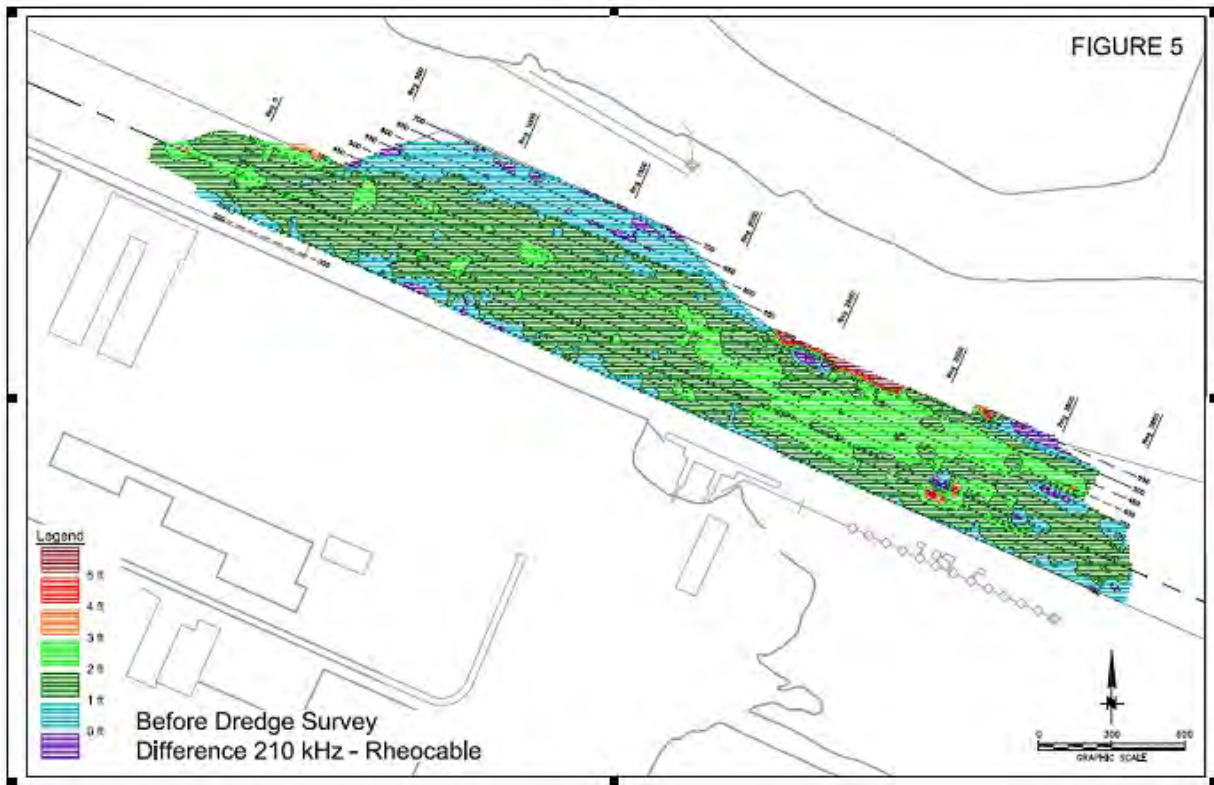

Figure P-18. Difference plot between Rheocable and 33-kHz depth measurements demonstrated in Wilmington Harbor, DE.

g. The STEMA System. The STEMA system consists of two primary components, a DensiTune (or RheoTune, see Figure P-19) probe and the SILAS software. The system is designed to estimate the nautical depth in navigation channels, the density of silt layers in dredge and disposal areas, and to monitor siltation in ports and marine traffic areas. The DensiTune (and RheoTune) are fluid mud profiling probes that operate on the “tuning fork” principle, with one of the legs of the tuning fork vibrating at a specific frequency, and the other leg vibrating at a frequency that depends on the density and rheological properties of the medium in which the probe is inserted. The DensiTune probe measures in situ density vs. depth, and the RheoTune system measures in situ density, shear strength, and viscosity vs. depth. The SILAS software was developed for the acquisition and processing of acoustic subbottom reflection signals in the low frequency range of 3.5 to 33 kHz. The low frequency acoustic returns are processed to determine signal attenuation and calibrated for density with the density profiles collected with the DensiTune or RheoTune.

(1) Under the USACE Dredging Operations and Environmental Research (DOER) program, The DensiTune and RheoTune density probes and SILAS software have been tested and evaluated on some USACE coastal navigation projects by the ERDC Coastal and Hydraulics

Laboratory (CHL), in conjunction with surveying conducted by the New Orleans District and the Mobile District. These tests indicate that these systems have potential for reliably measuring nautical bottom as previously described.

(2) The New Orleans District deploys Rheotunes from the S/V Teche by a semi automated winch down into the channel (see Figure P-20), to measure and record water and fluid mud densities and yield stresses as a function of depth. Figure P-21 presents an example of a DensiTune's density vs. depth profile from the Calcasieu Bar Channel (New Orleans District). Figure P-22 shows a SILAS-generated cross-section from the Gulfport Ship Channel (Mobile District), illustrating the concept of select density horizons generated from total acoustic reflection signals. Figure P-23 illustrates three different density horizons (1.20 g/cm^3 , 1.16 g/cm^3 , and 1.03 g/cm^3) relative to the Gulfport channel template.



Figure P-19. Stema RheoTune tuning fork shear strength, viscosity, and density probe.



Figure P-20. Rheotune probe being deployed off the New Orleans District S/V Teche via a semi-automated winch.

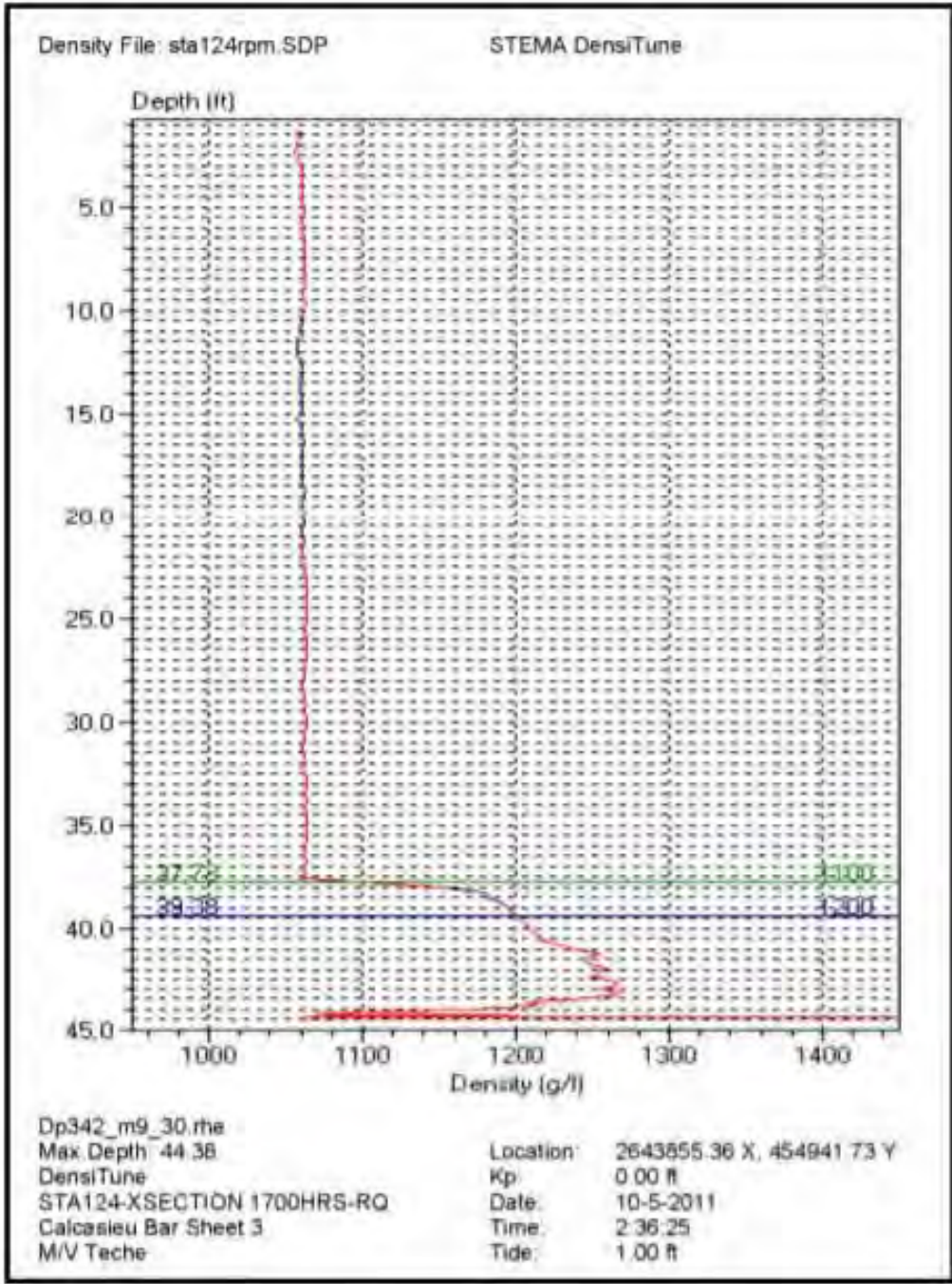

Figure P-21. STEMA DensiTune measurements taken in 42 ft Calcasieu Bar Channel on 05 Oct 11 at right quarterline one week following Wheeler Dredging Exercise. A density of 1100 g/l (green) was recorded at -37.0 ft depth and 1200 g/l (blue) at -39.0 ft. (New Orleans District)

EM 1110-2-1003
30 Nov 13

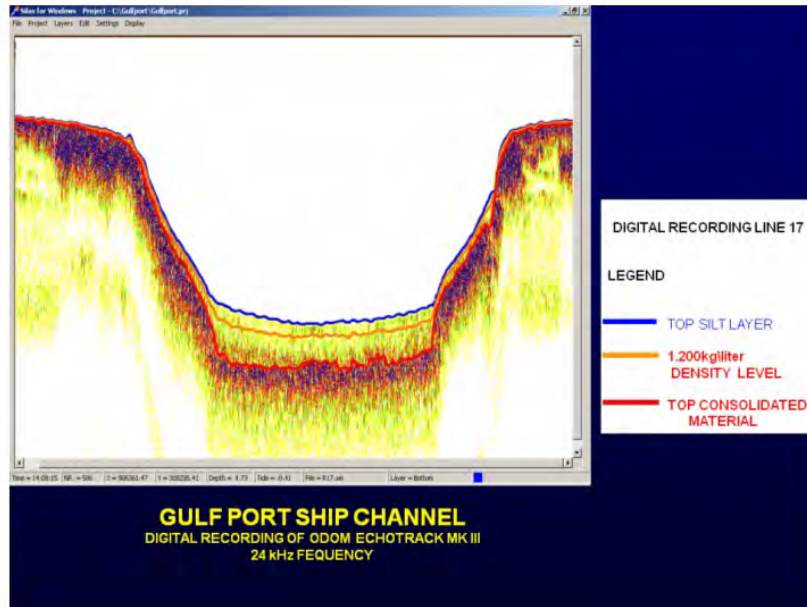

Figure P-22. SILAS-generated cross-section of Gulfport Ship Channel illustrating concept of measuring top of fluid mud, 1.2 g/cm³ density horizon, and top of consolidated material. (Mobile District)

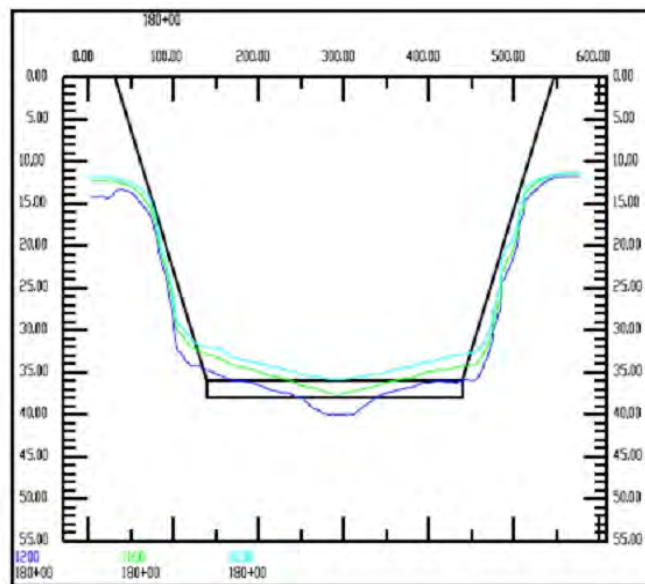

Figure P-23. SILAS-analyzed density horizons (1.20 g/cm³, 1.16 g/cm³, and 1.03 g/cm³) of STA 180+00 Gulfport Ship Channel 9 April 2012 relative to channel template. (Mobile District)

P-10. Recommended Procedures to Use in Unconsolidated Sediment Areas. When a survey is to be performed in a dredging area where fluid mud or fluff may exist, the following considerations should be observed if contract payment will be based on in-place measurements, or if payment is based on a daily rental basis. In areas where resolution of in-place payment quantities is extremely difficult with acoustic measurements, then a rental basis might be considered. In either case, determination of final project clearance and release of the dredge will require use of some of the techniques described below.

a. Determining frequency to use in a given project. Prior to any dredging it is necessary to establish what acoustic frequency best fits a project with existing fluid mud conditions. Or, in some cases, which frequency to use when fluff conditions exist only after dredging has been completed. If the depth measured by the independent check method (lead line, density probe, etc.) agrees with the high-frequency depth measurement, use the high-frequency depth measurement. If the depth measured by the independent check method does not agree with the high-frequency depth measurement but does agree with the low-frequency depth measurement, use the low-frequency depth measurement. Do not use the low-frequency depth reading on (or near) steeply sloped bottoms, pilings, or other structures.

b. Contract specifications. In areas of known fluid mud conditions, dredge contract specifications should detail the equipment and measurement techniques to be used during the project, such that an acceptable and equitable contract payment is achieved. Failure to identify known adverse site conditions results in unnecessary contract changes and modifications.

c. Acoustic frequency. Selection of this frequency should be based on its correlation with a practical criterion, i.e., selection of the physical fluid mud characteristic acting as a parameter for the nautical bottom approach and its critical value (e.g., 1.2 g/cm^3). Both the high- and low-frequency channels on the depth chart or digital record may be recorded, but in no case should frequencies be arbitrarily swapped, e.g., 24 kHz on a pre-dredge survey and 200 kHz on the after-dredge survey. The same frequency should be used for measurement and payment, and clearance assessment. Any variation in frequencies in the same area should be thoroughly justified. The construction contract specifications must indicate the frequency (or frequencies) to be used for channel clearance and payment. As an example, the Jacksonville District adds the following note on contract plans for known suspended sediment conditions in selected reaches (Ranges E thru I) of the Kings Bay (Navy) Entrance Channel in Florida/Georgia. This statement in the bid documents implies payment in the defined reaches will be made using the low frequency data.

VERTICAL MEASUREMENTS WERE MADE USING A ROSS SMART SOUNDER MODEL 835 DUAL FREQUENCY SOUNDER WITH A 28/200 KHZ SINGLE BEAM TRANSDUCER AND A RESON 8101 MULTIBEAM SYSTEM. SOUNDINGS SHOWN FROM RANGE A THRU RANGE D ARE IN HIGH FREQUENCY (200 KHZ) AND FROM RANGE E THRU RANGE I ARE IN LOW FREQUENCY (28 KHZ).

d. Single-beam vs. multibeam systems. Vertical single-beam systems are usually preferred in areas where fluff and/or fluid mud is a problem. Multibeam systems have bottom detection methods (amplitude, phase, interferometric) that vary with signal strength, automatic signal processing, angle of incidence, manufacturers, etc. As a result, in these areas, depth measurements may not be consistent from survey to survey, by different survey systems, and even on the same survey system at different beam angles.

e. Same survey vessel, depth measurement system, and crew. The same survey system should be employed throughout a dredging project. This will better ensure repeatability and consistency given the high variables that can occur between different depth measurement systems (e.g., echo sounders, etc.).

f. Establish, set, and monitor power and gain settings. The transmit/receive power and gain (sensitivity) settings should be established prior to dredging and not varied throughout the project unless changing site conditions (sea conditions or suspended sediment in water column possibly identified while doing a bar check) require a re-evaluation of the setting(s). These settings should be recorded in a field book. Periodically, the echo-sounder operator should evaluate the sensitivity of the gain on the recorded bottom and/or sediment layers—i.e., does a small change in gain significantly vary the depth measurement levels. Use of AGC and other automated signal processing filters is not recommended. (Maintaining consistent settings and related depth measurements can be a difficult process in fluid mud areas.)

g. Inconsistent cases. If the depth measured by an independent check method does not agree with either the high- or low-frequency depth measurements, then an alternate measurement system may be needed to determine clearance and/or payment. Under the Corps Monitoring Completed Navigation Program (MCNP) and Dredging Operations and Environmental Research (DOER) program, the ERDC is currently working with the Mobile District to develop and apply the operational requirements to implement nautical depth (as previously defined in this Appendix) in the Gulfport Ship Channel in Gulfport, MS. This implementation of nautical depth consists of the following activities:

- Form project delivery team to guide project execution including members from other Districts that have channels with fluid mud.
- Upgrade Mobile District surveyors with RheoTune and SILAS fluid mud surveying equipment (previously described in this appendix) and train personnel on its use to survey channel.
- Characterize channel's fluid mud physical characteristics (density, rheometry, etc.).
- Develop hydrodynamic model for ERDC ship simulator to calculate ship response to the variety of forces (Gulfport-specific environmental and mariner controlled) being exerted upon the vessel (without fluid mud) and have Gulfport pilots do runs to validate model.
- Modify ship simulator with fluid mud/ship maneuverability hydraulic coefficients.

- Have Gulfport Pilots operate simulator with different fluid mud densities and underkeel clearances to rate the difficulty of these respective maneuvers and define nautical bottom criterion and its respective critical value.
- Survey dredging operations to optimize maintenance dredging contract management.

a. All these data will be analyzed and activities synthesized to define criteria for implementing nautical bottom in the Gulfport Ship Channel, and a paradigm will be developed (including procedures, tools, guidance, etc.) for implementing nautical depth on a Corps-wide basis for applicable projects.

b. Savannah District has used the following contract measurement and payment clauses in practical attempts to address measurements in fluff.

"Soundings for all dredging surveys under this contract will be obtained by the use of a marine depth recorder operating at a frequency of [24 kHz]. Sensitivity setting will be adjusted to reflect the type of bottom material in the area being surveyed. In areas where double bottom (fluff) conditions are encountered, soundings with an 8-lb lead with a 6-in. perforated disc will be taken in conjunction with sounding data secured by the depth recorder. Adjust the data thus secured to the depths equivalent to those obtained by lead line soundings.

If soundings obtained as stated in the above paragraph (adjusted by lead line soundings) indicate a fluff or double bottom condition that exceeds 5 feet above the adjusted firm bottom, the firm bottom line will be adjusted to 5 feet below the fluff line. This adjusted firm bottom line will be used for yardage (volume) calculations."

P-10. Checklist for Depth Measurement in Irregular or Unconsolidated Bottoms. Table P-5 below is a general checklist for surveys that will be performed in irregular or unconsolidated materials. It is intended for use in developing measurement and payment provisions in dredging contracts during Preconstruction Engineering & Design (PED). It is not inclusive of all conditions encountered on Corps navigation projects.

Table P-5. Checklist for Depth Measurement in Unconsolidated Sediments--Dredging Contract Specifications (PED)

Identify potential existence of fluid mud or fluff in project--by reach/stationing if available
Contract by in-place measurement or rental?

Describe measurement and payment or clearance measurement system

- specify acoustic measurement system ... vessel, brand, etc.
- specify pre & post dredge frequency used for payment

EM 1110-2-1003

30 Nov 13

Describe alternate depth correlation method

- lead line or sounding pole, including measurement refusal times
- other nautical depth measurement methods
- detail procedure for correlating acoustic & mechanical depths

(If applicable) specify nautical depth criterion (and respective critical value) and suitable depth measurement systems.

Describe volume computation procedure (if in-place payment method used)

- data processing method
- data thinning method
- data set binning methods

Clearance procedures for rock fragments, underwater hazards, pipelines, etc.:

- acoustic sweep methods (bar, acoustic, side scan, etc.)
 - specific sweep system employed
 - sweep overlap criteria (single or double coverage)
 - required number of acoustic hits
 - tolerances designed for hazards in required depth and overdepth prisms
 - other clearance assessment methods
-

APPENDIX Q

Navigation Project Object Detection--Side Scan Sonar

Q-1. General Scope. This appendix provides a general overview on the use of side scan sonar techniques to search for objects lying above project grade in USACE navigation channels. Additional guidance is contained in the "NOS Hydrographic Surveys Specifications and Deliverables" manual (NOS 2011) and the NOAA "Field Procedures Manual,"(OCS 2011).

Q-2. Side Scan Sonar. Side scan sonar offers a high-resolution tool that provides a general depictive map on both sides of a survey vessel's path. Side scan sonar will not provide absolute elevations of objects. It will, however, provide relative elevations off the surrounding sea floor from which an approximate top elevation may be estimated. Side scan is a practical method for obtaining detailed acoustical pictures of the sea floor called sonographs, which are displayed on a computer screen with appropriate software, and can provide digital side scan records that can be permanently recorded. Digital side scan systems, when coupled with multibeam survey systems, have application in performing strike detection surveys or final acceptance clearance surveys in critical navigation channels.

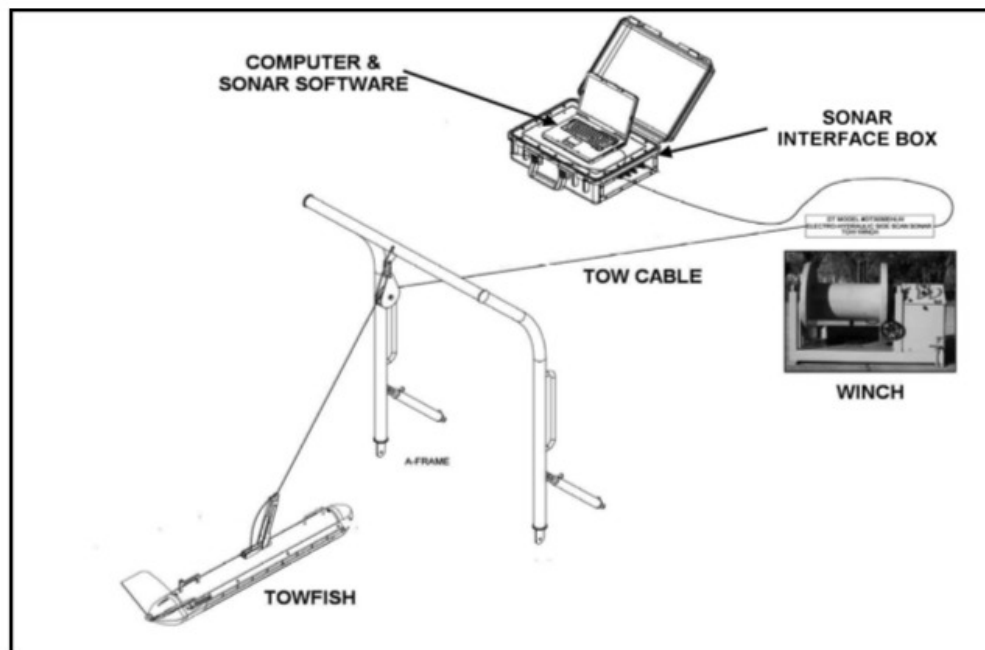

Figure Q-1. Block diagram of side scan sonar components.

a. Operating principles. A side scan sonar consists of a topside sonar interface box connected to a computer, an underwater sensor called a towfish, and a towing electro mechanical

EM 1110-2-1003
30 Nov 13

cable to connect the two shown in Figures Q-2. In basic operation, the side scan sonar has high voltage transmitter circuitry in the towfish that provides a short high intensity electrical pulse on command from the embedded computer in the towfish to the transducers, which then emit the acoustic pulse that propagates out through the water. Then over a very short period of time, the returning echoes from the sea floor are received by the transducers, amplified on a time varied gain curve, and transmitted up the tow cable to the topside sonar interface box and computer. The software in the computer further processes the signals, calculates the proper position for them in the final record, pixel by pixel, and then displays these echoes on data viewer window one scan or line, at a time. The horizontal beam width of side scan sonar is typically between 0.2 and 1 deg. The vertical beam width is typically 40 deg to the -3 db points of the beam pattern.

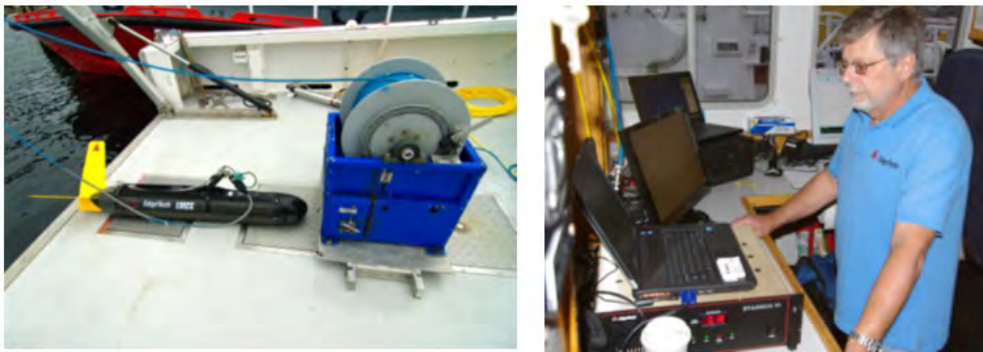

Figure Q-2. Basic components of a side scan sonar system. (left) Towfish and tow cable on winch. (Right) Sonar interface box and computer. (EdgeTech)

(1) The sonar data is logged digitally to the hard drive of the computer system and each ping is tagged with all pertinent data such as towfish position, heading speed, time, date, altitude, depth etc. Digital data collection will permit the application of slant range corrections in order to produce approximate planimetric images, which may be assembled into mosaics to depict large areas of sea floor. An example geo-referenced mosaic processed with SonarWiz 5 software (Chesapeake Technology, Inc.) is shown in Figure Q-3.

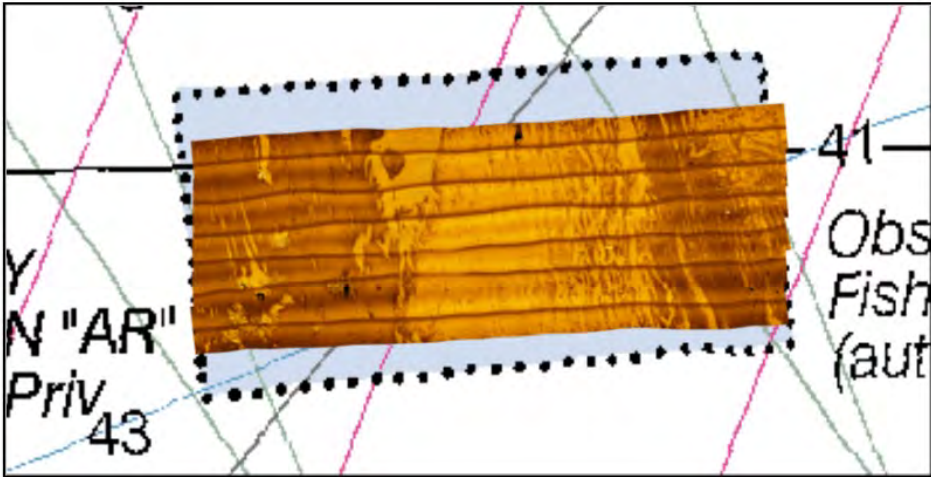

Figure Q-3. Sonar data processed with SonarWiz 5 software into a geo-referenced mosaic.

(2) A complete sidescan system deployed from a small vessel is depicted in Figure Q-4. Digital side scan data files can also be merged with concurrently recorded swath data from a multibeam system.



**EdgeTech Model 272-TD Series
Side Scan Sonar Tow fish**
**OIC GeoDas Seismic Data
Acquisition & Processing System**
Trimble DGPS
"Hypack" Navigation Software

Figure Q-4. Digital side scan display system (Sea Systems Corporation)

b. Tow height and speed. The quality of the sonar data is often a function of the height of the towfish above the bottom, or bottom targets during a survey or target imaging. In general, with standard sonar configurations, surveys are performed with the towfish positioned a distance above the bottom approximately equivalent to between 8 percent and 20 %of the range setting of the sonar. If the transducer array is towed high off the seafloor, shadowing will be lessened and target recognition may be reduced. If towed too low, the reflectivity at outer edges will be reduced limiting the effective range of the system. When the towfish is towed at less than 8 %above the bottom, the swath width that is considered achieved is reduced. NOAA's "Rule of Thumb" is: Below 8%, the achieved range = 12.5 x towfish height (m). The towing speed is adjusted such that 3 acoustical hits (pings) are received on an object.

c. Object imagery. The accuracy or ability of the system to detect a given size object is dependent on a number of factors, including the material type, size, and shape of the object, refraction, noise, biological interference, boat wakes, surface reflections, and towfish stability. On a homogeneous bottom type, shadow zones or lighter areas (or darker areas for digital reverse image display) on the sonar record are typically a function of the amount of ensonification an area receives. A shadow zone in front (towards the towfish) of a strong reflector indicates a depression in the sea floor. A shadow zone behind (away from the towfish) of a strong reflector indicates a rise in the sea floor.

d. Object height computation. Approximate heights of an object can be estimated from these shadows--see Figure Q-5. Acoustic reflectivity is a function of the size of the object (surface area presented), the shape of the object, its orientation relative to the towfish, and its composition. Steel or rock are good reflectors. Fiberglass, soft pine, plastics, and rubber are poor reflectors. Usually 200% scanning coverage is required with a side scan range scale set at 100 m. Confidence checks should be conducted daily to ensure the specified size object is being detected.

e. Object position determination. In order to accurately determine the position of a side scan sonar contact, we need to first determine the position of the vessel, and then translate that position to the towfish. The software provided today with side scan sonar systems have a layback algorithm that, when the correct inputs are applied, will estimate and calculate with good accuracy the geographic position of the towfish. The typical inputs for the layback calculation to work are x, y, & z offsets between the reference point (usually GPS antenna) on the survey vessel and the tow point, the amount of tow cable paid out (instrument pulley cable counters are very useful), and towfish depth (usually from a pressure sensor in the towfish). A typical example of layback setup is shown in Figure Q-6 for EdgeTech Discover software. The positioning of a target or feature now only requires the sonar operator to put the cursor over the target and click. The computer program will then automatically calculate a geographic position of the target as in Figure Q-7.

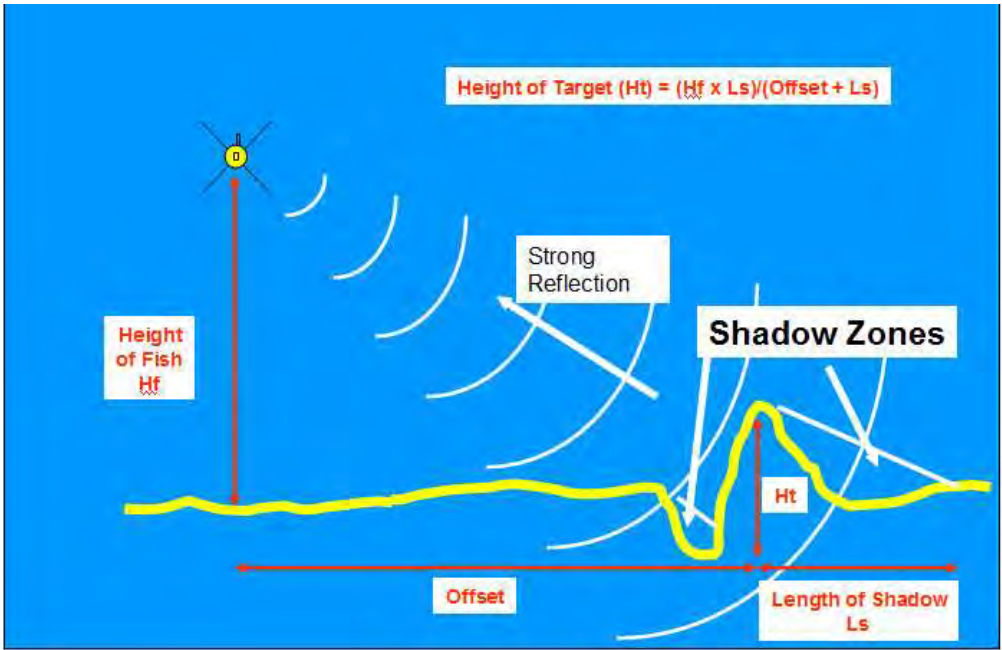

Figure Q-5. Side scan height and contact height computations (NOAA)

Layback

Cable Out: Manual, 0.00

Towfish Depth: Manual, 0.00

Towpoint Offsets: Alt: 0.00, Starboard: 0.00, Height: 0.00

Layback Calculation: Manual, Layback: []

Done

Layback = The square root of the difference between the square of the cable out and the square of the sum of the depth and towpoint height.
 $L = \sqrt{C^2 - (d + h)^2}$

Aft offset

GPS Antenna

Starboard offset

Reference Point

Tow Point

Height offset

Depth (Down +)

Layback

Using the equation that Layback equals the square root of the difference between the square of the cable out and the square of the sum of the depth and towpoint height. $L = \sqrt{C^2 - (d + h)^2}$

Figure Q-6. Layback setup parameters to allow target position calculations.

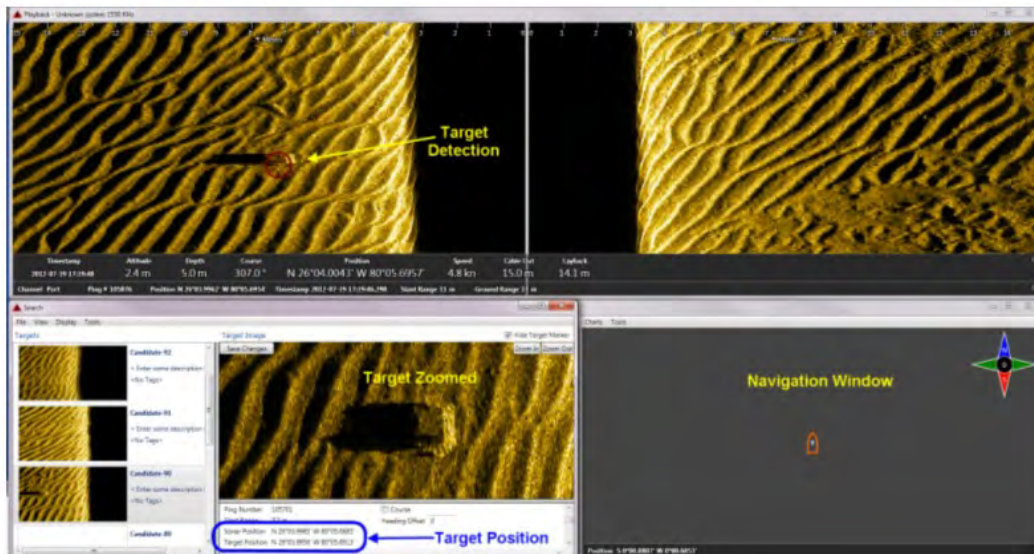

Figure Q-7. Target position calculated by software layback algorithm.
(EdgeTech Discover II software)

f. Side scan sonar images. In general, there are two ways to view sonar data. Slant range corrected data shows distances as if the bottom were flat as if taken by an aerial photograph. By knowing the fish height above the bottom, the slant range from the fish to the bottom can be rectified. In addition, speed correction based on the speed of the survey vessel is applied along track such to keep the scales the same in both axes. Therefore, for example, on the sonar display, 70 meters in the along-track direction will equal 70 meters in the across-track direction. Uncorrected records show the fish height as the first return and scales are different in across track and along track axis. True horizontal distances cannot be scaled directly from the uncorrected sonar display. The image shown in Figure Q-8 depicts uncorrected versus corrected data display. The sonar image shows fine sediment with a rock outcropping. A rock is shown with a bright mark, signifying a strong return. The black behind the rock is an acoustic shadow. The position of the rock is calculated by placing the cursor over the rock and clicking. The shadow height is scaled in the target zoom window to determine the height of the object off the bottom. Figure Q-9 depicts computer-generated side scan imagery enhancements that will provide significant detail of bottom objects or sediments.

g. Accuracy. Movement of the fish can cause a degradation of the side scan record. In particular, on a short tow in shallow water, the surface waves affecting the ship can have a coupling effect with the towfish. As it pitches fore and aft, the towfish experiences a similar dampened motion. The rapid accelerations and decelerations of the towfish degrade the sonar record.

- (1) Roll - The rhythmic movement of a ship or tow body along its longitudinal axis.

(2) Yaw - An instability characterized by the side-to-side movement of a ship or towed body about its vertical axis.

(3) Heave - The rise and fall of a surface vessel or towfish in a rhythmic movement.

(4) Pitch - An instability in the towfish expressed by the alternate rise and fall of the nose and tail about a horizontal axis.

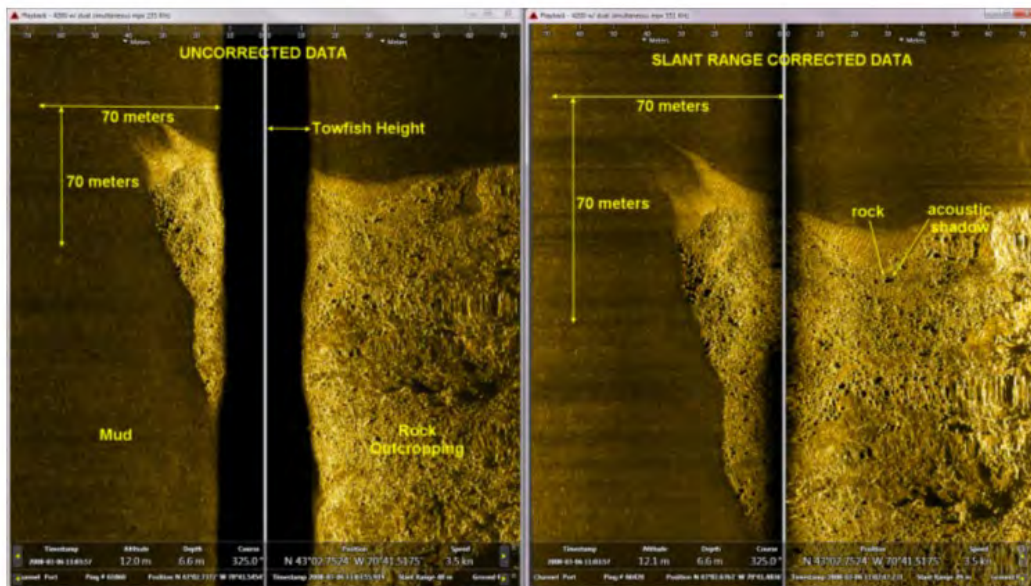

Figure Q-8. Side scan sonar record comparison of uncorrected versus corrected data display.

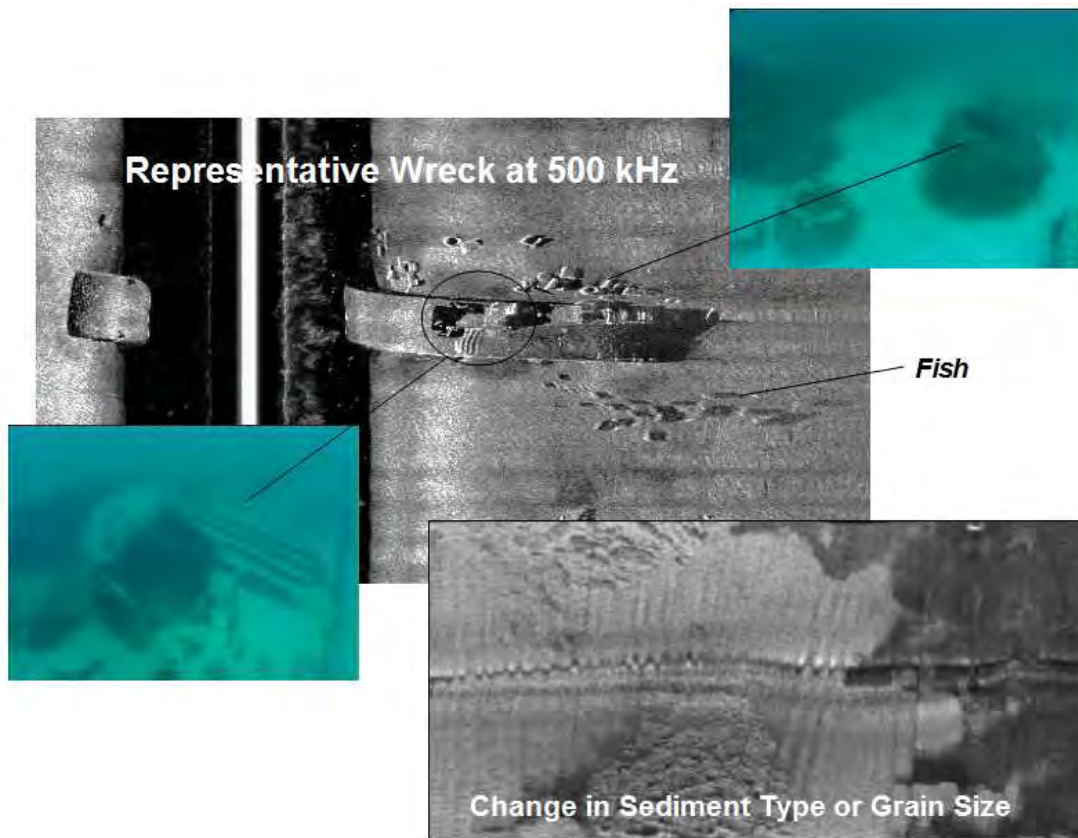

Figure Q-9. Enhanced side scan imagery depicting detailed underwater features. (Sea Systems Corporation and OIC GeoDas)

Q-3. Example Side Scan Sonar Survey Specifications (NOAA). The following paragraphs under this section contain excerpts from side scan specifications developed by NOAA ca 2000 for both internal survey forces and contracted forces. Although they were developed for nautical charting applications, these specifications and standards may be applicable to side scan survey operations performed by Corps in-house or contract crews on USACE navigation and dredging projects. Bracketed areas relate to project-specific information.

a. General Requirements. Side scan sonar shall be used to locate obstructions and a shallow water multibeam sonar system shall be used to determine the least depth over the obstructions. Side scan sonar data shall be collected over the channel areas indicated on the drawing in Figure Q-12, which is identical to that required for multibeam coverage. The Contractor shall acquire digital side scan sonar data using a towed system. The side scan sonar system shall be operated with a maximum range scale of 100 meters and with a towfish height

above the bottom of 8% to 20% of the range scale in use--see Figure Q-10. The side scan sonar data shall be horizontally referenced to [NAD 83].

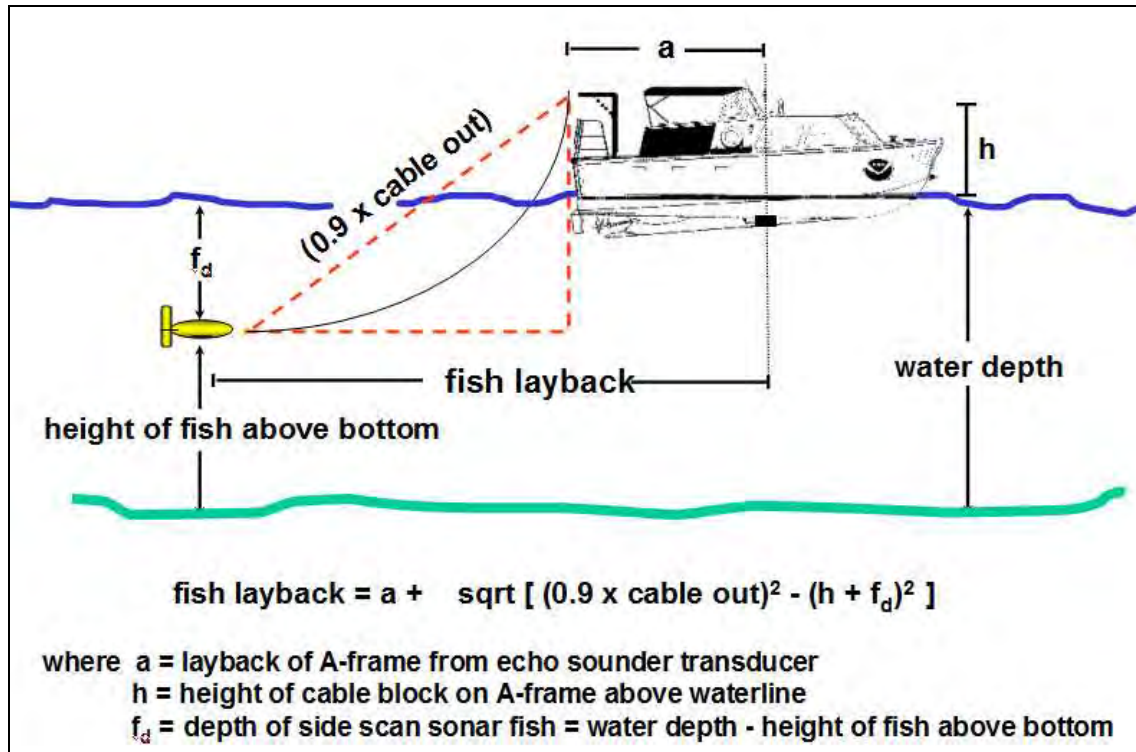

Figure Q-10. Height and position determination of towfish. (NOAA)

b. Accuracy. The side scan sonar system shall be operated in such a manner that it is capable of detecting an object that measures [0.5] [1.0] meter cube from shadow length measurements.

c. Towing Speed. Since the sonar is pulsing at a fixed rate based on its range scale, the speed that the towfish is being towed will have an affect on the ability to resolve items. In general, the slower the fish is towed the more definition is obtained. The side scan sonar shall be towed at a speed such that a detected object in the channel would receive a minimum of three pings per pass. The required towing speed may be computed as shown in Figure Q-11.

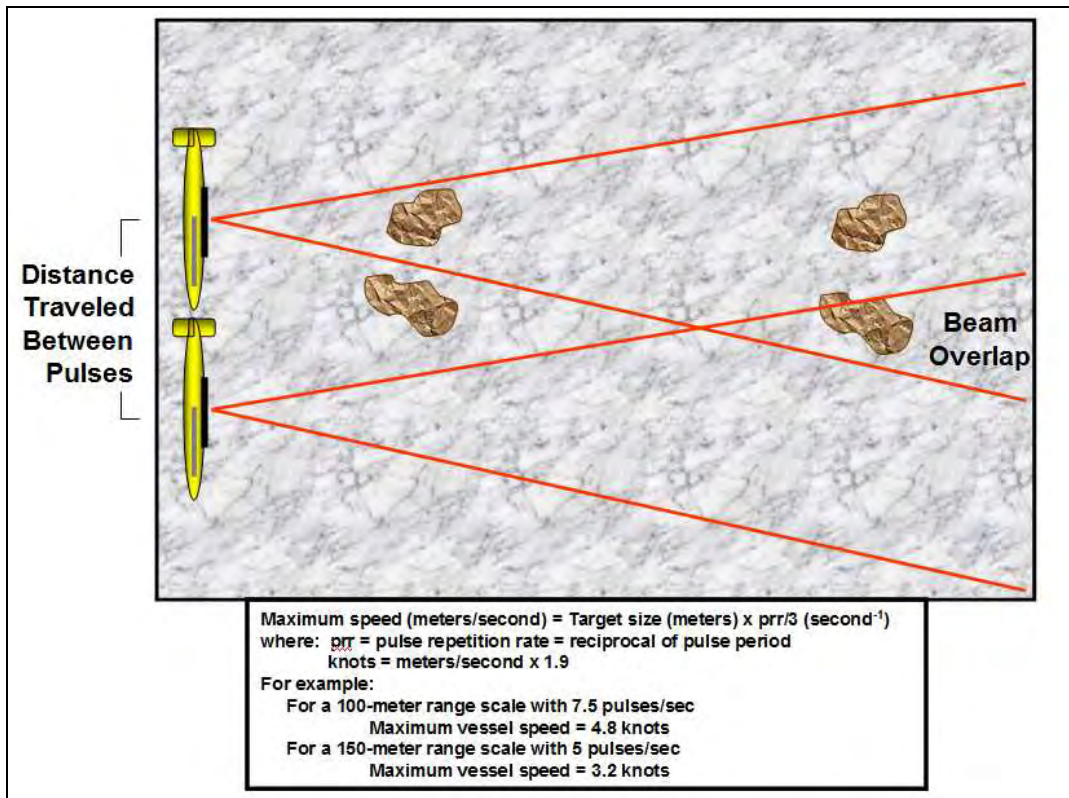

Figure Q-11. Determining towing speed for side scan sonar (NOAA)

d. Coverage. (Figure Q-12). The scanning coverage shall be 200%. "Scanning coverage" is the concept used to describe the extent to which the bottom has been covered by side scan sonar swaths, that is, the band of sea bottom which is ensonified and recorded on the side scan sonar record along a single vessel track line. Track line spacing shall be reduced from the maximum if the quality of the side scan sonar records deteriorate, i.e., record does not show features in the outer edges of the swath. For hydrographic purposes, scanning coverage of an area is expressed as multiples of 100%, and is cumulative. One-hundred percent coverage causes an area to be ensonified once, with a small overlapping area between adjacent swaths that is ensonified twice. For example, if a region of the bottom is ensonified twice, coverage of that region is said to be 200%. Approved 200% coverage techniques are as follows:

(1) Technique 1. Conduct a single survey wherein the vessel track lines are separated by one-half the distance required for 100% coverage.

(2) Technique 2. Conduct two separate 100% coverages wherein the vessel track lines during the second coverage split the distance between the track lines of the first coverage. Final track line spacing using this technique is essentially the same as Technique 1. The advantage of this method is that areas are viewed at different parts of the range scale for each run. (The ability

to distinguish targets directly under the fish and at short ranges is difficult. This method ensures an area is covered other than directly under the fish.) The disadvantage is that an obstruction with a narrow east/west aspect could be undetected.

(3) Technique 3. Conduct two separate 100% coverages in orthogonal directions. This method allows contacts to be ensonified from two different aspects. Also, depending on weather conditions, a vessel course can be selected to obtain the best return from the sonar. The disadvantage is that some areas have only been ensonified with the fish directly overhead.

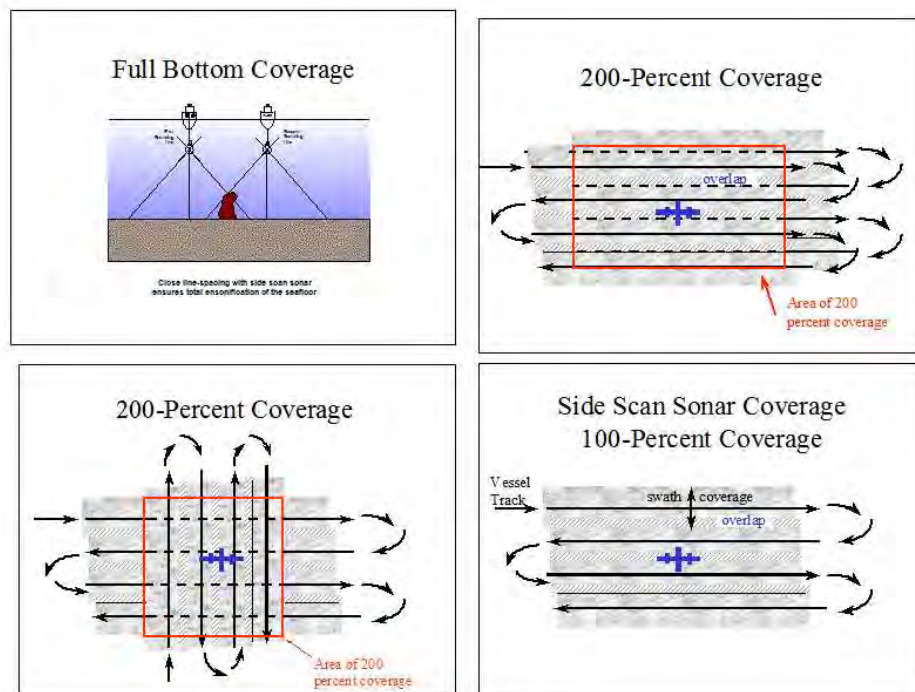

Figure Q-12. Side scan coverage. (NOAA)

Figure Q-12 shows a plan view of a side scan sonar search area. The object in the middle is a cartographic symbol signifying the submerged wreck that is being searched for. The dark lines with arrows represent the vessel trackline. On the 100% coverage sketch, the search was conducted by running east-west lines. The side scan sonar ensonifies an area to the north and south of the vessel trackline. The line spacing may be computed as follows:

Image-correcting:

Recommended Line Spacing = $(2 \times RS) - 40$ meters

Non-correcting:

Recommended Line Spacing = $(2 \times RS) - 40$ meters - $(0.05 \times RS)$

where RS = range scale (i.e., 100 or 150 m)

e. Quality Control.

(1) Confidence Checks. Confidence checks of the side scan sonar system shall be conducted at least once daily. These checks should be accomplished at the outer limits of the range scales being used based on a target near or on the bottom. Each sonar channel (i.e. port and starboard channels) shall be checked to verify proper system tuning and operation. Confidence checks can be made on any discrete object, offshore structure, or bottom feature that is convenient or incidental to the survey area. Targets can include wrecks, offshore structures, navigation buoy moorings, distinct trawl scours or sand ripples. Confidence checks can be made during the course of survey operations by noting the check feature on the sonagram. If a convenient or incidental target is not available, a known target may be placed on or near the bottom and used for confidence checks. Confidence checks shall be an integral part of the daily side scan sonar operation and shall be noted in the daily log book.

(2) Significant Contacts. Contacts with computed target heights (based on side scan sonar shadow lengths) of at least [0.5] [1.0] meter should be considered "significant." Other contacts without shadows may also be considered "significant" if the sonogram signature (e.g., size, shape, or pattern qualities) is notable.

(3) Correlate with Multibeam Data. The Contractor shall examine the multibeam data and correlate anomalous features or soundings with the side scan sonar data. The contractor shall examine and correlate targets between successive side scan sonar coverages (i.e., compare the first 100% with the second 100% sonar coverage). Anomalous features or targets which appear consistently and correlate in each type of data record provide increased confidence that acquisition systems are working correctly and help to confirm the existence of these features or targets. The Contractor shall cross reference and remark on each target correlation in the Remarks column of the Side Scan Sonar Contact List.

(4) Identification of Potential Field Examinations. The Contractor shall use the sonar contact list, in conjunction with an analysis of multibeam least depths, to identify hydrographic features which may require further examination. The contractor shall make recommendations for additional field examinations that are deemed necessary to establish survey completion.

f. Side Scan Sonar Contact List and Coverage Plot. The contractor shall produce a separate sonar coverage plot for each 100% side scan coverage. This provides a graphic means for documenting that the effective scanning swath from each search track sufficiently overlaps the effective scanning swath from adjacent tracks.

(1) Contact List. The Sonar Contact List is compiled manually using a form or as the output of an automated listing device. An acceptable method is described below. The column entries required on the Sonar Contact List are the specific elements of information which the Hydrographer needs to prepare the preliminary Sonar Contact Plot. The various column entries are described below, along with a brief discussion of how each is to be derived.

Column 1. Search Track Number - identifies the particular search track from which the contact was observed.

Column 2. Contact Number - uniquely identifies the contact. An example of a contact number is a number based on the date/time the contact was observed, followed by a letter indicating the port or starboard (P or S) channel; i.e., if a port-side contact is observed on day 181 at 150125, the contact number will be 181/150125P. Using signed (+ or -) contact range in column 4 eliminates the need for the P or S indicator.

Column 3. Towfish Layback - the approximate distance in meters from the positioning system antenna to the towfish. Unless computed by an automated system, the towfish may be assumed to be directly astern of the towing vessel and on the search track.

Column 4. Contact Range - the horizontal distance from the towfish track to the contact, expressed in meters. All ranges scaled from the sonogram are slant ranges for standard sonars, true ranges for image-correcting sonars. True ranges are obtained from slant-range information by geometric corrections using the Pythagorean Theorem.

Column 5. Contact Position - the preliminary position as determined by reconstruction of the vessel position, towfish layback, towfish position, port or starboard channel, and contact range at the time the contact was observed. The Contact Position shall be stated as a latitude/longitude.

Column 6. Estimate of contact height computed from range and shadow length.

Column 7. Remarks - used to denote first impressions of the contact's identity (wreck, rock, etc.), or to make any comments deemed appropriate. If after examining the records and correlating targets from overlapping coverage the Hydrographer determines that a contact does not warrant further investigation, it shall be noted as such. A brief statement of the reasons must be made. This determination should not be made until all numbered contacts are plotted on a preliminary Sonar Contact Plot. Any abbreviations should be defined on the list.

Column 8. Comparison with shallow water multibeam data - used to note the corresponding shallow water multibeam data (day/time, line number, etc.), the results of comparing the side scan sonar data with the multibeam data (e.g., contact did not appear in the multibeam data, SWMB least depth = x.x - SSS least depth = y.y), and the type of multibeam coverage (i.e., center beams or reconnaissance beams).

Column 9. Contact is depicted on a drawing [file] - yes/no.

Once added to the list, a contact should never be removed. If after further processing a contact is deemed not significant by the hydrographer, it shall be labeled as such in column 7. The

contact list, and any subsequent field examination lists and records developed from the contact list, shall be included with the data submission in both hard copy and digital forms.

(2) Contact Plot. The Contact Plot will show the position of all significant contacts entered on the Sonar Contact List. Only "significant" contacts, along with the views from adjacent lines, need to be plotted on the Sonar Contact Plot. In some areas, "significant" contacts may be clustered (e.g., debris, boulder fields). Such an area may lend itself to being depicted as a single feature with least depth(s). Only the most significant contact(s) in the group needs least depth(s) and position(s) determined.

g. Sonar Record Keeping. A daily log will be kept noting where applicable the following information and referenced to the digital data by time & date. . Time references shall be made in Coordinated Universal Time (UTC). Additional annotations will be added during contractor processing.

(1) Header Annotations. Header annotations are required to identify the sonar work and for ease of later reference. Header annotations are:

- (a) Registry number
- (b) Item number (AWOIS, if applicable)
- (c) Day of year and calendar date
- (d) Towing vessel
- (e) Tow Point

Header annotations shall be made:

- (f) at the beginning of a each survey line,
- (g) at the beginning of each day's work (for 24-hour operations, these annotations shall be made at the beginning of the first complete track of the new day),
- (h) when there is a change in the towing configuration during a day's operation.

(2) System-Status Annotations. System-status annotations are required to describe the sonar settings and the towing situation. System-status annotations are:

- (a) mode of tuning (manual or auto)
- (b) range-scale setting

- (c) left and right channel recorder settings
- d) operator's initials
- (e) length of tow-cable deployed (tow point to towfish)
- (f) depressor in use (yes or no)
- (g) weather and sea conditions

System-status annotations shall be made:

- (h) prior to obtaining the first position of the day,
- (i) prior to obtaining the first position at the start of a new survey line,
- (j) at any time the sonar has been switched off and then back on,
- (k) while on-line, approximately every hour, regardless of any changes made.

(3) First Position/Last Position Annotations. The following annotations shall be made at the first position on each search track:

- (a) Line begins (LB) or Line Resumes (LR)
- (b) tow-vessel heading (degrees true or magnetic)
- (c) towing speed (engine rpm, and pitch if applicable)
- (d) index number and time (at event mark)

The following annotations shall be made at the last position on each search track:

- (e) Line turns (LTRA, LTLA), Line breaks (LBKS), or Line ends (LE)
- (f) index number and time of event

(4) Special Annotations. The occurrence of any of the following events shall be annotated in the daily log, or as soon after as possible, the time the event occurs:

- (a) new index number (at event mark)

EM 1110-2-1003

30 Nov 13

- (b) change in operator (new initials)
- (c) change in range-scale setting
- (d) confidence checks
- (e) individual changes to sonar channel settings
- (f) change in tow-cable length (tow point to towfish)
- (g) change in towing speed (engine rpm and pitch) or vessel heading
- (h) change in tow point
- (i) significant contact observed (flag using an arrow)
- (j) surface phenomenon observed (wakes, passing vessels, etc.)
- (k) passes by buoys or other known features within sonar range
- (l) interference (state source if known)
- (m) time corresponding to the index marker.

The Hydrographer shall make any other annotations necessary to note any occurrence that may later serve to reconstruct the operation. Too much information is always better than not enough.

(5) Annotation Methods.

- (a) freehand in the daily log,
- (b) by use of a stamp,
- (c) by use of an automatic annotator or manual input to the sonar software program, if available.

The method is left to the Hydrographer's discretion, but should be used consistently throughout the operation.

h. Side Scan Sonar Data Format and Media. [The Government] will review the side scan with CARIS SIPS or Chesapeake Technologies SonarWiz 5 processing software . Therefore, all side scan data shall be submitted as a digital file stored in the industry standard XTF format, such that, the data can be loaded directly onto the workstation and viewed using CARIS SIPS or SonarWiz 5. The contractor shall include a file listing and describe the archiving method used,

and shall work with the Government to ensure no compatibility problems exist after data submission.

i. Final report of contacts. If a final survey report is required then side scan sonar operations should be included. Identify the manufacturer, model, and serial number of all side scan sonar equipment used. State the vertical beam width used and depression angle, if adjustable. State the frequency used (for example, 100 or 500 kHz). Briefly describe the operations. Include range scales, depths of water, standard line spacing, and point of deployment (bow, stern, or beam). Describe the methods and frequency of confidence checks. The percentage of area coverage (normally 100 or 200) obtained by the swaths should be noted. Where necessary, factors affecting data quality, such as towfish stability, signal interference, degraded returns due to thermoclines, and clutter, should be addressed. A discussion of side scan sonar work devoted exclusively to item investigation is not necessary in this section if the information is included in the Item Investigation Report, or an equivalent form, filed with the survey data. Methods and standards used to examine sonar records should be noted and a brief description of processing procedures should be provided. Two examples of topics include the methods for establishing proof of coverage and the criteria for selecting contacts.

Q-4. Channel Obstructions. Once an obstruction is detected from routine hydrographic surveys or other reports, a special survey is performed to determine its precise horizontal and vertical extent. The horizontal detection and mapping can be done by a variety of methods, but perhaps the best technique to help identify an obstruction is side scan sonar coupled with multibeam acoustic swath survey systems. Reciprocal headings past the target can provide average coordinates within 20 ft to 30 ft of the true obstruction location using DGPS code phase positioning. Divers can easily find targets at this accuracy provided a buoy can be deployed this close. Side scan can also locate the diver over the target by observing the trace of the air bubble reflections in the side scan record. The safety of the divers must be ensured with this procedure. Following a positive location, divers usually move the buoy sinker to the target for more precise horizontal positioning by a survey vessel. The new location of the marker buoy may be plumbed over the survey vessel bow and marked with an event from the navigation system. The improved horizontal coordinate is obtained from the vessel heading, magnetic declination, and distance to the bow from the antenna. In the vertical, the pinnacle elevation is most accurately determined by a bar sweep. Further elevations can be obtained by other high-resolution sensing equipment or physical inspection by diver. Targeted obstructions or objects can be removed or cleared by dredging, blasting, or recovery. Stealth-like objects, such as rock shards remaining after blasting, may be difficult to detect with standard, vertically-mounted, single-beam survey echo sounders. The return energy is buried within the noise level and sensitivity adjustments are not capable of distinguishing the object from the noise--see Figure Q-13. Very little of the pinnacled object is capable of reflecting sonic energy back to the transducer. However, there is a greater degree of side reflection if a side scan or multibeam system is used.

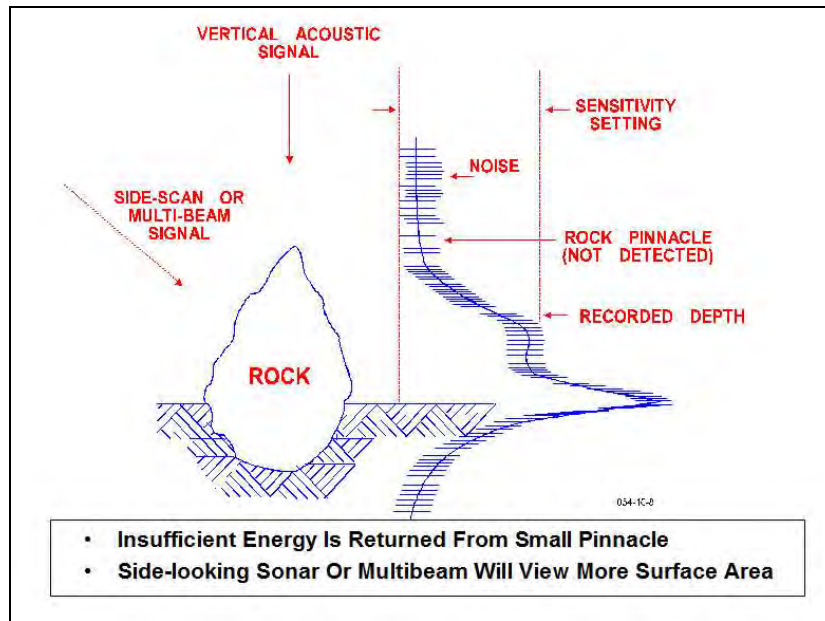

Figure Q-13. Acoustic return from a stealth-like object.

Multibeam and side scan imagery can be used to enhance the detection of underwater objects. This is illustrated in Figure Q-14 where an object is detected by both the multibeam array and the side scan imagery. The side scan imagery can also be overlaid onto the bathymetric data set, as illustrated in Figure Q-15.

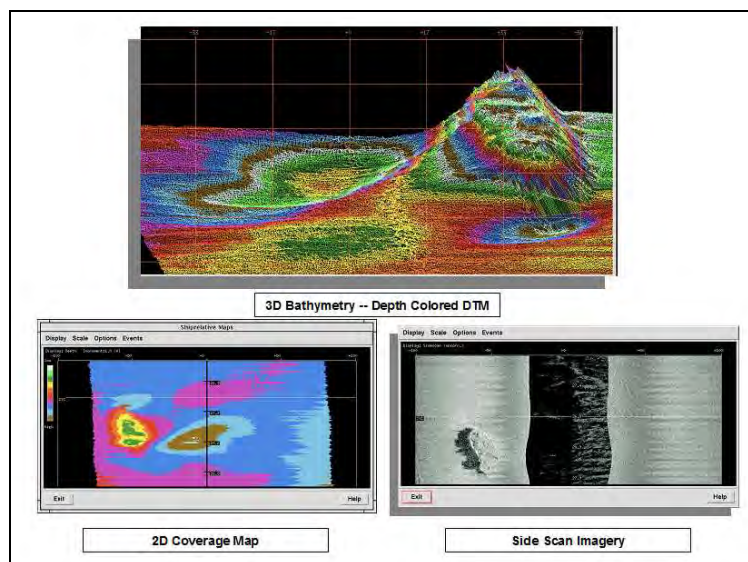

Figure Q-14. Combined Odom Echoscan multibeam and side scan imagery. (Odom Hydrographic Systems)

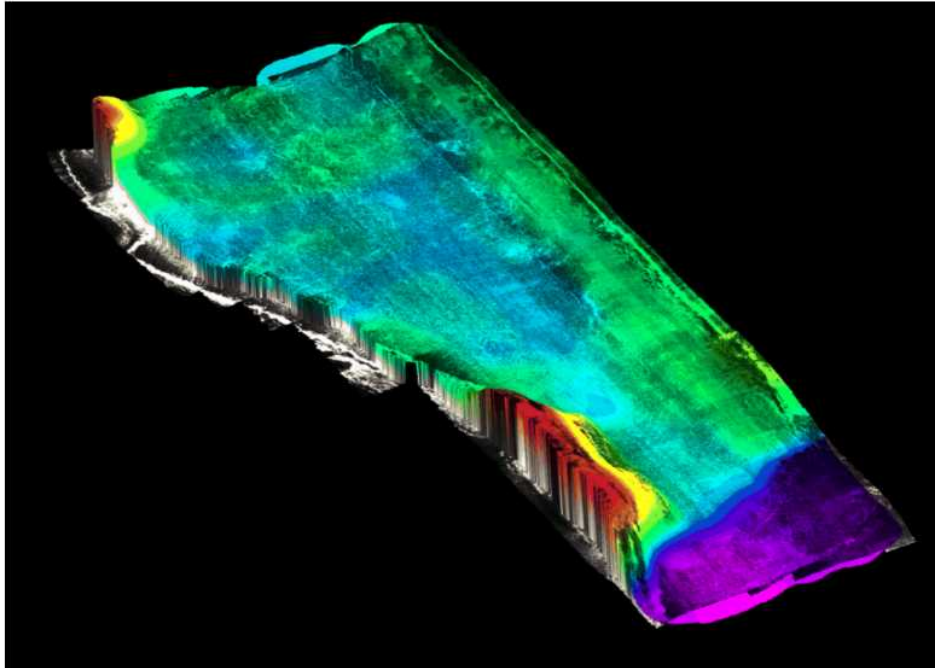

Figure Q-15. 3-D multibeam bathymetry with side scan imagery overlay. (Odom Hydrographic Systems)

Q-5. Magnetometer Surveys. Detection of ferromagnetic objects near the sea floor is possible through the measurement of magnetic anomalies with a magnetometer. Typical applications include detection of sunken ships, pipelines, communication cables, and other items that could hinder navigation or use of the sea floor.

a. Magnetometers are relatively simple to operate. The sensor head is towed behind the survey vessel at a distance of several boat lengths. If operations are conducted in shallow water, a buoy may be attached to the fish to prevent sinkage and to keep it at a consistent depth. Output on shipboard is real time in the form of a single line scribed on a strip chart. A variation in the line's position is an indication of the nearby presence of ferrous objects.

b. Magnetometers may be operated in towed pairs, termed gradiometers, which will measure the rate of change of magnetic lines, permitting approximate positioning of magnetic features on the bottom. Tow cables should be long enough to place the survey ship at sufficient distance so it will not affect readings.

EM 1110-2-1003
30 Nov 13

Q-6 SonarWiz 5. Quality Control and Quality Assurance Criteria.

Table Q-1. Quality Control and Quality Assurance Criteria for Side Scan Surveys

	Navigation & Dredging Support Surveys	
	Bottom Material Classification	
	Hard	Soft
RECOMMENDED COVERAGE	200%	100%
RECOMMENDED ACOUSTIC HITS	3 minimum	3
QA PERFORMANCE TEST	1/day	1/day

GLOSSARY

Abbreviations and Acronyms

1D or 1-D	One-Dimensional
2D or 2-D	Two-dimensional
3D or 3-D	Three-dimensional
AD.....	After Dredge
A-E.....	Architect-Engineer
ACSM.....	American Congress on Surveying and Mapping
ADCIRC.....	Advanced Circulation model
AEA	Average End Area
AEC/CAD	Architectural, Engineering, and Construction CAD (Standard)
AGC.....	Army Geospatial Center
ARP	Antenna Reference Point
ASCE.....	American Society of Civil Engineers
ASPRS.....	American Society for Photogrammetry and Remote Sensing
BD.....	Before Dredge
BFE	Base Flood Elevation
c/c.....	Center to Center
CAD	Computer Aided Design
CADD.....	Computer Aided Drafting and Design
CCR	Channel Condition Report
CD	Crew Day
CEPD.....	Comprehensive Evaluation of Project Datums
CERC.....	Coastal Engineering Research Center (CHL)
CH.....	Certified Hydrographer
CHL	Coastal and Hydraulics Laboratory
CHS	Canadian Hydrographic Service
COP	Community of Practice
COR.....	Contracting Officer's Representative

EM 1110-2-1003

30 Nov 13

CSV	Cross Sections and Volumes
CTD	Conductivity, Temperature, Depth
CW	Civil Works
cf	Cubic Foot
cy	Cubic Yards
DFIRM	Digital Flood Insurance Rate Map
CEFMS	Corps of Engineers Financial Management System
CEP	Circular Error Probable
CFR	Code of Federal Regulations
CHIRP	Compressed High Intensity Radar Pulse
CHL	Coastal and Hydraulics Laboratory
CHS	Canadian Hydrographic Service
cm	Centimeter
COEMLW	Corps of Engineers Mean Low Water
CONUS	Continental United States
CO-OPS	Center for Operational Oceanographic Products and Services
CORPSCON	CORPS Convert
CORS	Continuously Operating Reference Stations
COTS	Commercial Off-The-Shelf
CRAB	Coastal Amphibious Research Buggy
CRREL	Cold Regions Research & Engineering Laboratory
CSDL	Coast Survey Development Laboratory (NOS)
CTD	Conductivity Temperature Depth
CUBE	Combined Uncertainty and Bathymetry Estimator
CWIS	Civil Works Information System
DA	Department of the Army
dB	Decibel
DDR	Design Documentation Report
deg	Degree
DEM	Digital Elevation Model

demob	Demobilization
DEP	Department of Environmental Protection
DGPS	Differential Global Positioning System
DMD	Double Meridian Distance
DOD.....	Department of Defense
DOP	Dilution of Precision
DOT	Department of Transportation
DRMS.....	Deviations Root Mean Square
DTM	Digital Terrain Model
EC	Engineer Circular
ECDIS	Electronic Chart Display and Information System
ECL.....	Erosion Control Line
ECS	Electronic Chart System
EDM	Electronic Distance Measurement
EGES	Enterprise Geographic Engineering Systems
EM	Engineer Manual
EP.....	Engineer Pamphlet
EPA.....	Environmental Protection Agency
ER	Engineer Regulation
ERDC	Engineer Research and Development Center
ERS	Ellipsoid Referenced Survey
ETL	Engineer Technical Letter
ETL.....	Engineer Topographic Laboratory
FEMA.....	Federal Emergency Management Agency
FFP.....	Firm Fixed Price
FGCC.....	Federal Geodetic Control Committee
FGCS	Federal Geodetic Control Subcommittee
FGDC	Federal Geographic Data Committee
FIRM	Flood Insurance Rate Map
ft	Foot or Feet

EM 1110-2-1003

30 Nov 13

FTE	Full Time Equivalent
fps	Feet per second
GDOP	Geometric Dilution of Precision
GIS	Geographic Information System
GLONASS	GLOBAL Navigation Satellite System
GNSS	Global Navigation Satellite System
GPR	Ground Penetrating Radar
GPS	Global Positioning System
GRS80	Geodetic Reference System of 1980
H&H	Hydraulics and Hydrology
HEC	Hydrologic Engineering Center
HEC-RAS.....	HEC-River Analysis System
HI	Height of Instrument
HDOP	Horizontal Dilution of Precision
HP	Horsepower
HPR	Heave Pitch Roll
HQUSACE	Headquarters, US Army Corps of Engineers
HSPP.....	Hurricane and Shore Protection Project
HTRW	Hazardous Toxic Radioactive Waste
IAPPK.....	Inertial-Aided Post-Processed Kinematic
IDC	Indefinite Delivery Contract
IENC	Inland Electronic Navigational Chart
IGLD55	International Great Lakes Datum of 1955
IGLD85	International Great Lakes Datum of 1985
IHO	International Hydrographic Organization
IMU	Inertial Measurement Unit
IWW	Intracoastal Water Way
JALBTCX	Joint Airborne LIDAR Bathymetry Technical Center of Expertise
kHz.....	kilohertz
km	Kilometer

kts.....	Knots
KTD	Kinematic Tidal Datum
LARC	Lighter, Amphibious, Re-Supply, Cargo
lb	Pound
LIDAR.....	Light Detection And Ranging
LMSL	Local Mean Sea Level
LPCP.....	Local Project Control Point
LWD	Low Water Datum
LWRP	Low Water Reference Plane
m	Meter
mi	Mile
M&P	Measurement & Payment
MACOM	Major Army Command
MD	Man Day
MGL	Mean Gulf Level
MLG	Mean Low Gulf
MHT	Mean High Tide
MHW	Mean High Water
MLLW.....	Mean Lower Low Water
MLT.....	Mean Low Tide
MLW	Mean Low Water
Mn.....	Mean Tide Range
Mob.....	Mobilization
MRU	Motion Reference Unit
MSC.....	Major Subordinate Command
MSE.....	Mean Square Error
MSL.....	Mean Sea Level
MTL.....	Mean Tide Level
MV or M/V	Motor Vessel
MVD.....	Mississippi Valley Division

EM 1110-2-1003
30 Nov 13

NAD27 North American Datum of 1927
NAD83 North American Datum of 1983
NADCON North American Datum Conversion
nm Nanometer
NAVAID Navigation Aid
NAVCEN Navigation Center (US Coast Guard)
NAVD88 North American Vertical Datum of 1988
NAVOCEANO US NAVal OCEANographic Office
NGS National Geodetic Survey
NGVD29 National Geodetic Vertical Datum 1929
NOAA National Oceanic and Atmospheric Administration
NOS National Ocean Service
NSDI National Spatial Data Infrastructure
NSRS National Spatial Reference System
NTDE National Tidal Datum Epoch
NTE Not To Exceed
NWLON National Water Level Observation Network
NWLP National Water Level Program
OCONUS Outside the Continental United States
OCS Office of Coast Survey
O&M Operations and Maintenance
OTF On-The-Fly GPS (real time kinematic carrier)
OPUS On-Line Positioning User Service
ORD Ohio River Datum
PBM Permanent Bench Mark
PCS Project Condition Survey
PDF Portable Document Format
PE Professional Engineer
PED Preconstruction Engineering and Design
PFD Personal Flotation Device

PI.....	Point of Intersection
PIANC	Permanent International Association of Navigation Congresses
PID	Position Identification
PLS	Professional Land Surveyor
POB	Point of Beginning
POD	Print on Demand
POS/MV	Positioning and Orientation System—Marine Vessels (Applanix Corp.)
PPCP.....	Primary Project Control Point
PPK.....	Post-Processed Kinematic
RPM.....	Revolutions per Minute
P&S.....	Plans and Specifications
ppm	Parts per million
PPS.....	Precise positioning service
ppt	Parts per thousand
PRC.....	Pseudo Range Corrections
PRIP.....	Plant Replacement and Improvement Program
PROSPECT.....	Proponent Sponsored Engineer Corps Training
QA.....	Quality Assurance
QC.....	Quality Control
RF	Dario Frequency
RMS.....	Root Mean Square
RMSE	Root Mean Square Error
RTK	Real Time Kinematic
RTN	Real Time Network
S/A.....	Selective Availability
SB or S/B.....	Survey Boat
SV or S/V	Survey Vessel
SAR	Synthetic aperture radar
SDSFIE	Spatial Data Standards for Facilities, Infrastructure, and Environment
SEP	Spherical Error Probable

EM 1110-2-1003

30 Nov 13

sf..... Square feet
SIM Site Information Modeling
SLD29..... Sea Level Datum of 1929
SPCS State Plane Coordinate System
sq ft Square foot
sqrt Square root
STA..... Station
SSS..... Side Scan Sonar
SV Sound Velocity
TBM Temporary Bench Mark
TCARI Tidal Constituent And Residual Interpolation
TEC..... Topographic Engineering Center
TIN..... Triangular Irregular Network
TM Transverse Mercator
THU Total Horizontal Uncertainty
TPU..... Total Propagated Uncertainty
TTN Topological Triangle Network
TVG Time Varied Gain
TVU Total Vertical Uncertainty
U/M..... Unit of measure
U/P Unit price
ULC USACE Learning Center
UNB..... University of New Brunswick
URL Universal Resource Locator
US (U.S.):..... United States
US United States
USACE US Army Corps of Engineers
U.S.C. United States Code
USC&GS US Coast & Geodetic Survey
USCG US Coast Guard

USED	US Engineer Datum
USGS	US Geological Survey
UTC	Universal Time Coordinated
UTM	Universal Transverse Mercator
VEQ	Variation in Estimated Quantities
VDatum	(National) Vertical Datum
VDOP	Vertical Dilution of Position
VRN	Virtual Reference Network
WES	Waterways Experiment Station
WGS84	World Geodetic System of 1984
WRDA	Water Resources Development Act
WS	Water Surface (elevation)
XYZ or X-Y-Z	3D point coordinates

EM 1110-2-1003
30 Nov 13

THIS PAGE INTENTIONALLY LEFT BLANK